

FRP and Utility Panels / Parts List

EFFECTIVE: 07.20.05 (supercedes 02.14.05)



Chicago Metallic[®]
CEILING SYSTEMS & SPECIALTY PRODUCTS

Table of Contents

3	Notes
3	Service Levels
4	Freight
7	Buyers' Responsibilities
09-10	Index
09	Products
10	Manufacturers Product Cross Reference
12	Colors
12	Listing
13-16	Pallets
13	Panel Palletization
17-24	DynaGlass™
18	FRP Suspension
20	FRP Wall Panels
22	FRP Ceiling Panels
23	Accessories
25-26	Endure™/Endure™ Plus
27-33	Soft Touch™
28	5/8" Vinyl/Fiberglass
29	1" and 3" Vinyl/Fiberglass
30	Nubby-Fabric/Fiberglass
32	Sierra™ F-Fabric/Fiberglass
33	Sierra™ M-Fabric/Mineral
34	General Conditions of Sale

Service Levels represents the approximate time in weeks for an order to be ready to ship from the manufacturing plant. Add 2 weeks to all Service Levels for CM transfer truck to Baltimore or Los Angeles Service Centers. Service Level begins when the following criteria are met – Receipt of acceptable Purchase Order, Credit Approval, Drawing Approval, Color Approval.

Service Levels	Production Lead Time
0	Stock item available for immediate shipment
1	Available to ship within 1 week of order acceptance
2	Available to ship within 2 weeks of order acceptance
3	Available to ship within 3 weeks of order acceptance
4	Available to ship within 4 weeks of order acceptance
5	Available to ship within 5 weeks of order acceptance
6	Available to ship within 6 weeks of order acceptance
??	Contact Chicago Metallic for current lead time

1. The Service Level of an order will be based on the longest lead time item.
2. Lead times may vary from the Service Levels listed due to demand.
3. Some items may have order size limitations tied to the Service Level. Please check the Product Notes for each product line to determine the proper Service Level for your order.
4. Projects larger than the maximum size listed may be produced within published Service Levels.

Freight Policies

- All orders will be shipped F.O.B. manufacturing facility.

Shipment Size	Freight Terms and Conditions
0 lbs. - 4,999 lbs.	All orders for L.T.L. shipment will be shipped prepaid and charge on an approved carrier. Shipments will incur charges for freight, packaging and handling, with all charges being added to the invoice under "Shipping & Handling Charges".
5,000 lbs. - 11,999 lbs.	Freight paid with a \$100.00 stop off charge. Classified as a pool shipment combined with others to fill the truck.
12,000 lbs. - 23,999 lbs.	Freight paid by CM. Classified as a pool shipment and combined with others to fill the truck.
24,000 lbs. - 39,999 lbs.	Freight paid by CM. Classified as a truckload shipment, other stops may be added to fill the truck.
40,000 lbs. - 48,000 lbs.	Full truckload to a single destination.

1. Pool shipment of orders less than 24,000 pounds will be made within 2 weeks following the "available to ship date" of the material or shipped L.T.L. at CM expense.
2. At the customer's request, CM will ship orders less than 24,000 pounds via common carrier to a single destination. However, the customer is responsible for all freight charges on the shipment.

- Fuel surcharges may be passed through to the invoice.

Detention of Truckloads

All truckload shipments specify "free time" for unloading (generally 2 hours). Detention past this time may result in charges.

Re-routing of Truckloads

Re-routing of truckload shipments require authorization by CM. Any charges will be invoiced.

L.T.L., Air Freight, and UPS orders

All orders received by 11:00 a.m. C.S.T. for Service Level 0 items will be shipped the same business day. Orders received after 11:00 a.m. C.S.T. will be shipped the next business day.

L.T.L. Freight Collect Shipments

These orders will incur the following packaging and handling charges:

1. Products 4' in length and under - \$25.00.
2. Products over 4' up to and including 12' in length - \$75.00.
3. Products over 12' in length - \$150.00.
4. Over 20 cartons of any size - Special Quote.

Air Freight Shipments

All orders received for air freight shipments will be shipped at the customer's expense. The total charges for these shipments will be quoted on the day of shipment by Customer Service.

U.P.S. Shipments

All orders will be charged the actual rate based on the total weight of the shipment, including packaging.

"Will Call" Orders

Orders may be picked up at a CM facility, Monday through Friday, from 7:00 a.m. until 3:00 p.m. All "Will Calls" will be serviced on a first come, first served basis. It is necessary to schedule an appointment for "Will Call" orders 24 hrs in advance on all orders over 5,000 lbs. Please have your CM order confirmation number when picking up an order. CM will not honor claims for shortages or damages on "Will Call" shipments once the order has left the CM facility.

Freight Classifications

Freight Rates may be quoted by Customer Service.

Chicago Metallic will also ship L.T.L. orders on carriers specified by the customer. The following CM shipping locations and zip codes will be needed by your carrier to determine your freight charges.

		Chicago, IL 60638	Baltimore, MD 21075	Los Angeles, CA 90640	Brownsville, TX 78521	Cleveland, OH 44105	Coshocton, OH 43812	Gilroy, CA 95020	Milwaukee, WI 53221	Minneapolis, MN 55412	Montgomeryville, PA 18936	Moscow, TN 38057	Oceanside, NY 11572	Plymouth, WI 53073	Riverdale, MD 20737	Sun Prairie, WI 53590
Product Type	Freight Class															
Access Doors/GRG	70	■	■	■				■								
BeamGrid	70	■	■	■		■										
Ceiling Grid	50	■	■	■												
CubeGrid	70	■	■	■												
CurvGrid	70	■	■	■												
DynaGlass FRP	60	■	■	■								■				
DynaGlass FRP Grid	60	■	■	■												■
Endure/Endure Plus	60	■	■	■										■		
EuroClean/EuroClean PVF	60	■	■	■							■					
EuroFoam	60	■	■	■						■						
EuroStone	60	■	■	■	■											
GraphGrid	70	■	■	■												
Insulation Pads/Rolls	200	■	■	■												
Infinity	60	■	■	■												
Intaline	70	■	■	■												
Magna T-Cell (assem.)	150	■	■	■												
Magna T-Cell (unassem.)	70	■	■	■												
Monarch	60	■	■	■					■							
Metaline	60	■	■	■			■									
Planar/PlanarPlus	70	■	■	■												
PlanarMacro/MacroPlus	70	■	■	■												
Planostile	70	■	■	■												
Securline	60	■	■	■			■									
Soft Touch	200	■	■	■												
Traditions	55	■	■	■									■			
Trims & Reveals	60	■	■	■											■	

Build-A-Truck

Build-A-Truck allows you to combine several different types of products on the same truck from the CM Service Centers in Chicago, Baltimore, and Los Angeles.

The following items are eligible for Build-A-Truck:

- All Ceiling Grid including Drywall grid systems
- Access Doors
- BeamGrid
- Cornerbead
- CubeGrid
- CurvGrid
- DynaGlass
- Endure
- EuroClean/EuroClean PVF
- EuroFoam
- Eurostone
- Hanger Wire
- Infinity
- GraphGrid
- Intaline
- Magna T-Cell
- Metaline
- Planar/PlanarPlus
- PlanarMacro/MacroPlus
- Planostile
- Securline
- Soft Touch
- Traditions
- Trims & Reveals

Freight Guidelines For Ceiling Panels and Metal Ceilings

Please use the following chart to determine the appropriate freight to be applied to orders for Ceiling Panels and Specialty Ceiling Products

Product Name	Quantity	Build-A-Truck	Freight
BeamGrid	Any Quantity	Yes	No Charge on Build-A-Truck
CubeGrid	Any Quantity	Yes	No Charge on Build-A-Truck
DynaGlass	Any Quantity	Yes	No Charge on Build-A-Truck
Endure – Vinyl-Gypsum	Any Quantity	Yes	No Charge on Build-A-Truck
EuroClean	Any Quantity	Yes	No Charge on Build-A-Truck
EuroClean PVF	Any Quantity	Yes	No Charge on Build-A-Truck
EuroFoam	Any Quantity	Yes	No Charge on Build-A-Truck
EuroStone (Service Level “0”)	Any Quantity	Yes	No Charge on Build-A-Truck
GraphGrid	Any Quantity	Yes	No Charge on Build-A-Truck
Infinity	Any Quantity	Yes	No Charge on Build-A-Truck
Intaline	Any Quantity	Yes	No Charge on Build-A-Truck
Magna T-Cell	Any Quantity	Yes	No Charge on Build-A-Truck
Metaline	Any Quantity	Yes	No Charge on Build-A-Truck
Monarch	Any Quantity	Yes	No Charge on Build-A-Truck
Planar/PlanarPlus	Any Quantity	Yes	No Charge on Build-A-Truck
PlanarMacro/MacroPlus	Any Quantity	Yes	No Charge on Build-A-Truck
Planostile	Any Quantity	Yes	No Charge on Build-A-Truck
Securline	Any Quantity	Yes	No Charge on Build-A-Truck
Soft Touch – Fiberglass	Any Quantity	Yes	No Charge on Build-A-Truck
Trims & Reveals	Any Quantity	Yes	No Charge on Build-A-Truck
Traditions	Any Quantity	Yes	No Charge on Build-A-Truck

Installation Drawings

1. Service Level begins after receipt of shop drawing approval.
2. Installation drawing charges are quoted on a per request basis and are determined by the scope of the project.
3. Installation drawings are included on all Engineered Infinity projects and BeamGrid installations.
4. Installation drawings are not Engineered Shop Drawings, which require greater detail.

Color Samples

1. Custom color matching requires customer color sample or paint manufacturer and color number.
2. CM will provide color sample for approval upon request.
3. Service Level begins after receipt of color approval.

Pricing

Pricing reflects the colors listed by product, gauge and substrate.

Order Review

Customer Service direct: 1.888.991.7070.

Order Placement

Orders to be faxed to 1.888.329.2620.

Overruns

Orders differing from the products available in the Price List either by size, gauge, length, pattern or color are subject to a 10% overrun, shipments and invoice.

Responsibility

Report any material defect to CM prior to its installation. CM is not responsible for labor incurred or any costs associated with the installation of its products. See the CM Limited Warranty for all products in General Conditions of Sale (Back Cover).

The Buyer accepts responsibility and all related costs associated for installed materials. CM is not responsible for defects in the materials once the material has been installed.

Tolerances

Tolerances will be in accordance with CM's published standards which are in effect on the date of the order.

Returns and Restocking Charges

1. Only Service Level 0 items will be accepted for return.
2. Items must be in their original unopened packaging.
3. Items must have been purchased within 90 days of the request to return the material.
4. You must receive prior authorization and a Returned Goods Authorization number from CM in order to return the material.
5. Materials must be returned within 45 days of the issuance of the Returned Goods Authorization.
6. Freight will be at the Customer's expense.
7. A 20% restock fee will apply to all returns.
8. CM will inspect all returned materials, and only issue credit on those items received in resaleable condition.
9. CM will not be responsible for any damage that occurs to material in transit.

Cancellations

Cancellation of items with a Service Level greater than 0 may result in cancellation charges. Charges will be based on the value of materials and all costs incurred by CM at the time of cancellation.

Terms

1. 1% 10 days, Net 30 days.
2. A 1% per month storage charge will be applied on materials delayed from shipment at the Customer's request more than two weeks beyond the available date.

Notes

Index

Colors

Pallets

DynaGlass

Endure/Endure Plus

Soft Touch

NOTES

Product Index

Product Number	Page Number	Product Number	Page Number	Product Number	Page Number
7010	14, 28	8801	13, 20		
7013	14, 28	8802	13, 20		
7020	14, 28	8810	13, 20, 21		
7023	14, 28	8811	13, 20, 21		
7040	14, 28	8812	13, 20, 21		
7043	14, 28	8813	13, 20, 21		
7110	14, 29	8820	13, 20		
7113	14, 29	8821	13, 20		
7120	14, 29	8822	13, 20		
7123	14, 29	8823	13, 20		
7137	14, 29	8830	13, 20		
7139	14, 29	8830	21		
7140	14, 29	8832	13, 20, 21		
7143	14, 29	8833	13, 20, 21		
7500	15	8850	22		
7501	15	8851	22		
7502	15, 30	8852	13, 22		
7508	15, 30	8853	13, 22		
7509	15, 30	8855	22		
7510	15, 30	8856	22		
7511	15, 30	8860	23, 24		
7512	15, 30	8861	23, 24		
7513	15, 30	8862	23, 24		
7515	15, 30	8863	23, 24		
7517	15, 30	8864	23, 24		
7520	15, 30	8865	23, 24		
7521	15, 31	8866	23, 24		
7522	15, 31	8867	23, 24		
7523	15, 31	8868	23		
7524	15, 31	8870	18		
7525	15, 31	8872	18		
7526	15, 31	8874	18		
7527	15, 31	8878	18		
7551	15, 32	8880	18		
7552	15, 32	8881	18		
7553	15, 32	8882	18		
7561	15, 33	8884	18		
7562	15, 33	8885	18		
7563	15, 33	8887	23		
7771	13, 26	8888	23		
7773	13, 26	8889	23		
7870	26				
7871	13, 26				
7874	13, 26				
8800	13, 20				

Notes

Index

Colors

Pallets

DynaGlass

Endure/Endure Plus

Soft Touch

Product Cross Reference Guide

Chicago Metallic

AWI

USG

BPB

DynaGlass	–	–	–
Endure	–	Sheetrock® Sheetrock Plus®	Vinylrock™
Endure Plus	–	Clean Room™	Enviroguard™
Soft Touch Vinyl	Fiberglass	Premier Hi-Lite™	Commercial
Soft Touch Nubby	Painted Nubby	Premier Nubby™	Open Plan Nubby
Soft Touch Sierra F	Optima™	Mars High NRC™	Symphony F™
Soft Touch Sierra M	Ultima™	Mars	Symphony M™

Notes

Index

Colors

Pallets

DynaGlass

Endure/Endure Plus

Soft Touch

Product Cross Reference Guide

Chicago Metallic	MBI	Glasteel	National Gypsum	Crane
DynaGlass	–	Glasliner™	–	Glasbord™
Endure	–	–	Gridstone™	–
Endure Plus	–	–	–	–
Soft Touch Vinyl	–	–	–	–
Soft Touch Nubby	MBI Nubby™	–	–	–
Soft Touch Sierra F	–	–	–	–
Soft Touch Sierra M	–	–	–	–

Notes

Index

Colors

Pallets

DynaGlass

Endure/Endure Plus

Soft Touch

Not all products available in all colors and finishes

Numerical

Natural – Standard Colors

00	Bare	21	Copper Metallic	33	Manila	379	Gloss White	430	Beige Breeze
01	White	23	Sandstone	44	Satin Silver Metallic	386	Gloss Black	431	White Wash
03	Bronze Metallic	25	Adobe	46	Blush	425	Wet Clay	432	Blondewood
07	Walnut Grain	27	Parchment	47	Cameo	426	Silver Plate		
08	Black	28	Tan	81	Bronze	427	Glass Block		
10	01 White with Black 08 Stripe	29	Platinum	94	Clear Coat	428	Yellow Flash		
		30	Haze	137	Ebony Bronze Metallic	429	Silver Lining		

Prestige – Premium Colors

88	Flat Black	167	Brick Red	263	Plum	435	Gray Ice	446	Treetop Green
102	Fossil	174	Garnet	270	Pearl Gray	436	Violet Star	447	Cinnamon
104	Tapioca	197	Teal	274	Cloud White	437	Midnight Blue	448	Carmel Brown
106	Vanilla Crème	198	Spruce	277	Cedar	438	Royal Amethyst	449	Fortune Gray
111	Oyster	215	Forest	278	Dawn	439	Mystic Moss	450	Khaki Cloth
112	Sand Dollar	218	Mint	279	Sienna	440	Frosted River	451	Forest Jade
113	Straw	238	Ice Blue	280	Redwood	441	Brown Bear	452	Aqua Shoreline
114	Boston Coffee	240	Blue Grey	283	Cobblestone	442	Burgundy Brick	453	Desert Sand
151	Quartz	241	Slate	287	Charcoal	443	Toffee Fate	454	Palmetto Olive
158	Real Red	246	Federal Indigo	288	Gun Metal	444	Blue Sky	455	Cocoa Shell
161	Chinese Red	256	True Blue	386	Gloss Black	445	Cajun Spice	495	Cardinal Red

Reflective Finishes

Anodized Finishes

Stainless Steel

Fiberglass Reinforced Plastic

056	Bright Brass	14	Chromecoat	600	Stainless Steel 2B	011	White	405	Lite Grey
058	Bright Mirror	16	Brasscoat		Wood	013	Bright White	406	Colonial
369	Brushed Gold	020	Gunmetal	298	Designer Oak Vinyl	11S	Gloss White	410	Marble
371	Preferred Lacquer Mill	504	Satin Anodized	xxF	Finished Veneer	403	Ivory		
378	Brushed Aluminum	509	Coppercoat	xxU	Unfinished Veneer	404	Silver		

Alpha

Natural – Standard Colors

Adobe	25	Bronze Metallic	03	Gloss White	379	Silver Plate	426	Walnut Grain	07
Bare	00	Cameo	47	Haze	30	Sandstone	23	White Wash	431
Beige Breeze	430	Clear Coat	94	Manila	33	Tan	28	Yellow Flash	428
Black	08	Copper Metallic	21	Parchment	27	Wet Clay	425		
Blondewood	432	Ebony Bronze Metallic	137	Platinum	29	White	01		
Blush	46	Glass Block	427	Satin Silver Metallic	44	White 01 with Black 08			
Bronze	81	Gloss Black	386	Silver Lining	429	Stripe	10		

Prestige – Premium Colors

Aqua Shoreline	452	Charcoal	287	Forest Jade	451	Mint	218	Sienna	279
Blue Grey	240	Chinese Red	161	Fortune Gray	449	Mystic Moss	439	Slate	241
Blue Sky	444	Cinnamon	447	Fossil	102	Oyster	111	Spruce	198
Boston Coffee	114	Cloud White	274	Frosted River	440	Palmetto Olive	454	Straw	113
Brick Red	167	Cobblestone	283	Garnet	174	Pearl Gray	270	Tapioca	104
Brown Bear	441	Cocoa Shell	455	Gloss Black	386	Plum	263	Teal	197
Burgundy Brick	442	Dawn	278	Gray Ice	435	Quartz	151	Toffee Fate	443
Cajun Spice	445	Desert Sand	453	Gun Metal	288	Real Red	158	Treetop Green	446
Cardinal Red	495	Federal Indigo	246	Ice Blue	238	Redwood	280	True Blue	256
Carmel Brown	448	Flat Black	88	Khaki Cloth	450	Royal Amethyst	438	Vanilla Crème	106
Cedar	277	Forest	215	Midnight Blue	437	Sand Dollar	112	Violet Star	436

Reflective Finishes

Anodized Finishes

Stainless Steel

Fiberglass Reinforced Plastic

Bright Brass	056	Brasscoat	16	Stainless Steel 2B	600	Colonial	406	Marble	410
Bright Mirror	058	Chromecoat	14	Wood		Gloss White	11S	Silver	404
Brushed Aluminum	378	Coppercoat	509	Designer Oak Vinyl	298	Ivory	403	Bright White	013
Brushed Gold	369	Gunmetal	20	Finished Veneer	xxF	Lite Grey	405		
Preferred Lacquer Mill	371	Satin Anodized	504	Unfinished Veneer	xxU				

Product Number & Name	Carton Per Pallet	Weight Per Pallet	Sq. Ft. Per Pallet	Carton Weight	Sq. Ft. Per Carton
DynaGlass					
8800.013	100	2800	3200	28	32
8801.013	100	3500	4000	35	40
8802.013	100	4200	4800	42	48
8810.013	100	1800	3200	18	32
8811.xxx	100	2100	3600	21	36
8812.xxx	100	2300	4000	23	40
8813.xxx	100	2700	4800	27	48
8820.013	100	1300	3200	13	32
8821.013	100	1500	3600	15	36
8822.013	100	1600	4000	16	40
8823.013	100	2000	4800	20	48
8830.xxx	100	1800	3200	18	32
8832.xxx	100	2300	4000	23	40
8833.xxx	100	2700	4800	27	48
8852.013	500	3000	4000	6	8
8853.013	1000	3000	4000	3	4
Endure and Endure Plus					
7773.01V Concord	44	2640	1408	60	32
7771.01V Concord	44	2640	1408	60	32
7874.01V Concord	44	2860	1408	65	32
7871.01V Concord	44	2640	1408	60	32

Notes

Index

Colors

Pallets

DynaGlass

Endure/Endure Plus

Soft Touch

Panel Palletization

Pallets

Product Number & Name	Carton Per Pallet	Weight Per Pallet	Sq Ft Per Pallet	Carton Weight	Sq Ft Per Carton
Soft Touch					
7013.01F Coral	24	396	2304	16.5	96
7023.01F Cyprus	24	576	2304	24.0	96
7043.01F Capri	24	768	2304	32.0	96
7010.01F Coral	24	396	2304	16.5	96
7020.01F Cyprus	24	396	2304	16.5	96
7040.01F Capri	24	396	2304	16.5	96
7013M01F Coral	14	396	2304	16.5	96
7023M01F Cyprus	14	576	2304	24.0	96
7043M01F Capri	14	768	2304	32.0	96
7010M01F Coral	14	396	2304	16.5	96
7020M01F Cyprus	24	396	2304	16.5	96
7040M01F Capri	24	396	2304	16.5	96
Soft Touch Plus					
7113.01F Coral	14	462	1344	33	96
7123.01F Cyprus	14	462	1344	33	96
7143.01F Capri	14	462	1344	33	96
7110.01F Coral	14	462	1344	33	96
7120.01F Cyprus	14	462	1344	33	96
7140.01F Capri	14	462	1344	33	96
7139.01F Chateau	14	448	448	32	96
7137.01F Chateau	14	448	448	32	96
7113M01F Coral	14	462	1344	33	96
7123M01F Cyprus	14	462	1344	33	96
7143M01F Capri	14	462	1344	33	96
7110M01F Coral	14	462	1344	33	96
7120M01F Cyprus	14	462	1344	33	96
7140M01F Capri	14	462	1344	33	96
7139M01F Chateau	14	448	448	32	96
7137M01F Chateau	14	448	448	32	96

Product Number & Name	Carton Per Pallet	Weight Per Pallet	Sq Ft Per Pallet	Carton Weight	Sq Ft Per Carton
Soft Touch Nubby					
7508.01N Nubby	18	576	2304	32	128
7500.01N Nubby	14	476	1792	34	128
7510.01N Nubby	14	476	1344	34	96
7520.01N Nubby	14	476	896	34	64
7509.01N Nubby	18	576	2304	32	128
7501.01N Nubby	14	476	1792	34	128
7511.01N Nubby	14	476	1344	34	96
7521.01N Nubby	14	476	896	34	64
7512.01N Nubby	7	469	1344	67	192
7522.01N Nubby	7	468	896	67	128
7513.01N Nubby	14	938	2688	67	192
7524.01N Nubby	14	938	1792	67	128
7515.01N Nubby	14	378	1050	27	75
7525.01N Nubby	14	728	1400	52	100
7517.01N Nubby	21	735	2100	35	100
7527.01N Nubby	21	735	1407	35	67
7502.01N Nubby	14	728	2100	52	150
7526.01N Nubby	14	728	1400	52	100
7523.01N Nubby	7	728	1400	104	200
Soft Touch Sierra F					
7551.01 Sierra F	14	476	1344	34	96
7552.01 Sierra F	14	476	1344	34	96
7553.01 Sierra F	14	476	1344	34	96
Soft Touch Sierra M					
7561.01 Sierra M	16	896	896	56	56
7562.01 Sierra M	16	896	896	56	56
7563.01 Sierra M	16	896	896	56	56

Notes

Index

Colors

Pallets

DynaGlass

Endure/Endure Plus

Soft Touch

NOTES

DynaGlass™

FRP Suspension

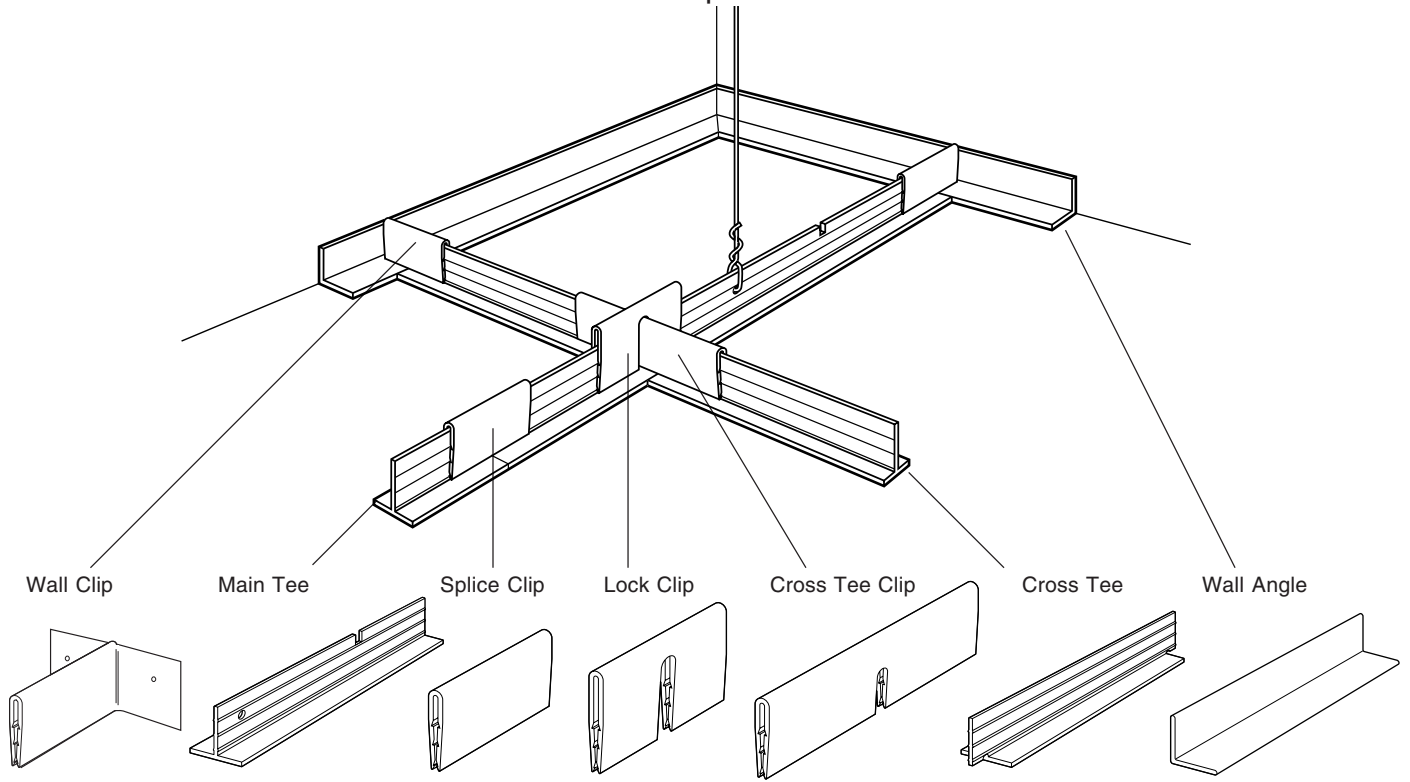

Product Notes:

- Notes:
- Suspension products sold in full cartons only.
 - Accessories sold in full cartons only, except Wall Clip (#8885.01) sold per piece.
 - Class A (1) Flame Spread of 5 per UL No. 723, Smoke Development of 65.

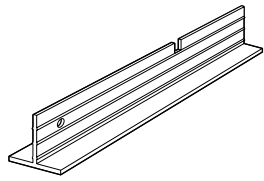

Main Tee
8870

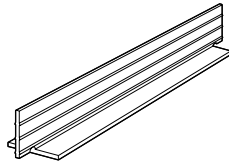

Cross Tee
8872-8874

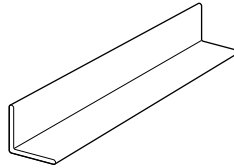

Wall Angle
8878

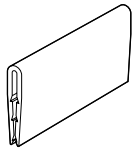

Splice Clip
8880

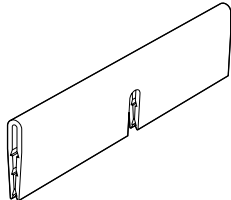

Cross Tee Clip
8881

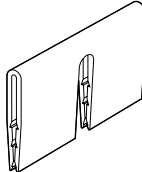

Lock Clip
8882

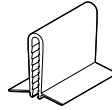

Hold Down Clip
8883-8884

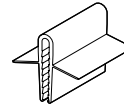

Hold Down Clip
8884

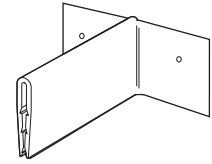

Wall Clip
8885

Product Number	Dimensions			Per Carton			Service Level
	Length	Height	Face	LF	Pcs	Wt	

Suspension – 01 White

Main Tee

8870.01	12'	1 3/8"	1 3/8"	288	24	80	1
---------	-----	--------	--------	-----	----	----	---

Cross Tees

8872.01	2'	1 3/8"	1 3/8"	192	96	50	1
8874.01	4'	1 3/8"	1 3/8"	192	48	50	1

Wall Angle

8878.01	8'	1 1/2"	1 1/2"	312	39	98	1
---------	----	--------	--------	-----	----	----	---

Product Number	Description	Per Carton		Service Level
		Pcs	Wt	

Accessories – All items sold in full cartons except wall clip (per piece)

8880.01	Splice Clip – For joins Tees and grid end supports	300	30	1
8881.01	Cross Tee Clip – Assembles cross tees to system	300	38	1
8882.01	Lock Clip – Holds cross tee clip in place	300	20	1
8883.01	Hold Down Clip – Holds panels down	1250	25	1
8884.01	Hold Down Clip – for 1" thick ceiling panels	1250	25	1
8885.01	Wall Clip/Splice Clip joins Tee/tee to wall angle	300	30	1

DynaGlass™

Fiberglass Reinforced Plastic (FRP) Wall and Ceiling Panels

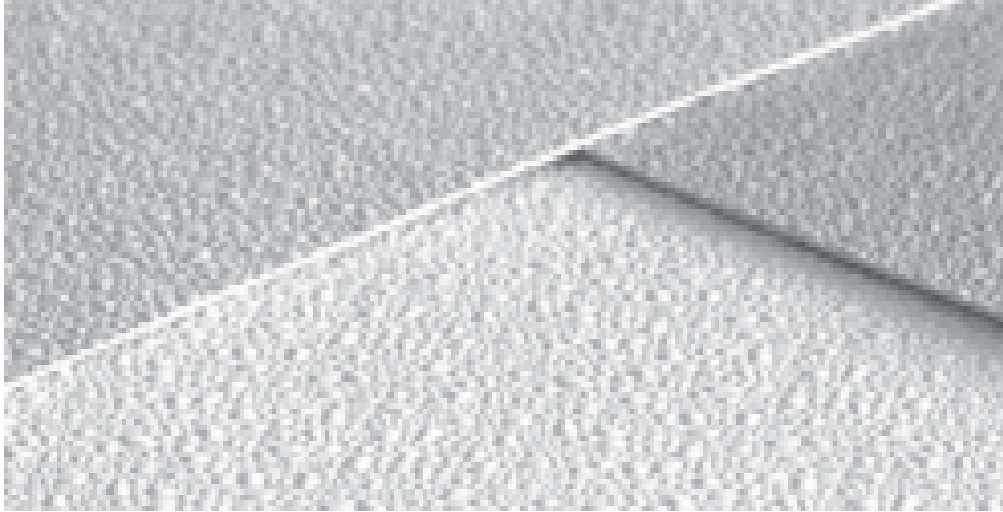

Fiberglass Reinforced Plastic (FRP) Wall / Ceiling Panels

Product Notes:

Product Notes:

- Notes:
- Class A panels have a low profile stretched texture that is visually different from Class C texture.
 - Minimum order is 5,000 Sq. Ft. (\pm 10%) per product.
 - Accessories are not Class A rated products.

Product Number	Fire Class	Panel		Sq. Ft.	Per Piece	Wt	Service Level
		Size	Thickness				

FRP Wall Panels

013 Bright White – Textured

8800.013	C	4' x 8'	0.12"	32	28	4
8801.013	C	4' x 10'	0.12"	40	35	4
8802.013	C	4' x 12'	0.12"	48	42	4
8810.013	C	4' x 8'	0.09"	32	18	0
8811.013	C	4' x 9'	0.09"	36	21	3
8812.013	C	4' x 10'	0.09"	40	23	0
8813.013	C	4' x 12'	0.09"	48	27	4
8820.013	C	4' x 8'	0.06"	32	13	4
8821.013	C	4' x 9'	0.06"	36	15	4
8822.013	C	4' x 10'	0.06"	40	16	4
8823.013	C	4' x 12'	0.06"	48	20	4
8830.013	A	4' x 8'	0.09"	32	18	3
8832.013	A	4' x 10'	0.09"	40	23	3
8833.013	A	4' x 12'	0.09"	48	27	3

013S Bright White – Smooth

8810.013S	C	4' x 8'	0.09"	32	18	3
8811.013S	C	4' x 9'	0.09"	36	21	3
8812.013S	C	4' x 10'	0.09"	40	23	3
8813.013S	C	4' x 12'	0.09"	48	27	3

Product Number	Fire Class	Panel		Per Piece		Service Level	Price Per Sq. Ft.	Price Per Piece
		Size	Thickness	Sq. Ft.	Wt			
FRP Wall Panels								
410 Marble – Textured								
8810.410	C	4' x 8'	0.09"	32	13	3		
8811.410	C	4' x 9'	0.09"	36	15	3		
8812.410	C	4' x 10'	0.09"	40	16	3		
8813.410	C	4' x 12'	0.09"	48	20	3		
Colors: 403 Ivory 404 Silver 405 Lite Grey 406 Colonial								
8810.xxx	C	4' x 8'	0.09"	32	13	3		
8811.xxx	C	4' x 9'	0.09"	36	15	3		
8812.xxx	C	4' x 10'	0.09"	40	16	3		
8813.xxx	C	4' x 12'	0.09"	48	20	3		
8830.xxx	A	4' x 8'	0.09"	32	13	6		
8832.xxx	A	4' x 10'	0.09"	40	16	6		
8833.xxx	A	4' x 12'	0.09"	48	20	6		

xxx - Insert proper color code from list above.

Product Number	Fire Class	Panel		Sq. Ft.	Per Piece		Service Level
		Size	Thickness		Wt		

Ceiling Panels

013 Bright White – Textured

8853.013	C	2' x 2'	0.09"	4	2.3	2
8852.013	C	2' x 4'	0.09"	8	4.6	2
8856.013	A	2' x 2'	0.09"	4	2.3	3
8855.013	A	2' x 4'	0.09"	8	4.6	3
8851.013	C	2' x 2'	0.12"	4	2.3	2
8850.013	C	2' x 4'	0.12"	8	4.6	2

013 Bright White – Smooth

8853.013S	C	2' x 2'	0.09"	4	2.3	2
8852.013S	C	2' x 4'	0.09"	8	4.6	2
8856.013S	A	2' x 2'	0.09"	4	2.3	3
8855.013S	A	2' x 4'	0.09"	8	4.6	3
8851.013S	C	2' x 2'	0.12"	4	2.3	2
8850.013S	C	2' x 4'	0.12"	8	4.6	2



Standard Division Bar
8860-8861



Inside Corner
8862-8863



Outside Corner
8864-8865



End Cap
8866-8867

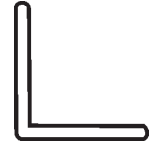

Outside Corner Angle
8887-8888-8889

Product Number	Length	Description	Per Carton		Service Level
			Pcs	Weight	

013 Bright White

8860.013	8'	Standard Division Bar	50	25.0	0
8861.013	10'	Standard Division Bar	50	31.5	0
8862.013	8'	Inside Corner	50	25.0	0
8863.013	10'	Inside Corner	50	31.5	0
8864.013	8'	Outside Corner	50	25.0	0
8865.013	10'	Outside Corner	50	31.5	0
8866.013	8'	End Cap	50	20.0	0
8867.013	10'	End Cap	50	30.0	0
8868.013	3/4"	Plastic Rivets	100	0.25	0
8887.013	8'	Outside Corner Angle	30	48.0	0
8888.013	10'	Outside Corner Angle	30	60.0	0
8889.013	12'	Outside Corner Angle	30	72.0	0

Colors: 403 Ivory 404 Silver 405 Lite Grey 406 Colonial

8860.xxx	8'	Standard Division Bar	50	25.0	3
8861.xxx	10'	Standard Division Bar	50	31.5	3
8862.xxx	8'	Inside Corner	50	25.0	3
8863.xxx	10'	Inside Corner	50	31.5	3
8864.xxx	8'	Outside Corner	50	25.0	3
8865.xxx	10'	Outside Corner	50	31.5	3
8866.xxx	8'	End Cap	50	20.0	3
8867.xxx	10'	End Cap	50	30.0	3

xxx - Insert proper color code from list above.

Notes

Index

Colors

Pallets

DynaGlass

Endure/Endure Plus

Soft Touch

Notes
Index
Colors
Pallets
DynaGlass
Endure/Endure Plus
Soft Touch

Product Number	Length	Description	Per Carton		Service Level
			Pcs	Weight	
Colors: 410 Marble					
8860.410	8'	Standard Division Bar	50	25.0	3
8861.410	10'	Standard Division Bar	50	31.5	3
8862.410	8'	Inside Corner	50	25.0	3
8863.410	10'	Inside Corner	50	31.5	3
8864.410	8'	Outside Corner	50	25.0	3
8865.410	10'	Outside Corner	50	31.5	3
8866.410	8'	End Cap	50	20.0	3
8867.410	10'	End Cap	50	30.0	3

Endure™/Endure™ Plus

Vinyl/Gypsum Laminated Panels



Concord (1/2")
7773-7771-7874-7871

Product Notes:

- Notes:
- Product sold in full cartons only.

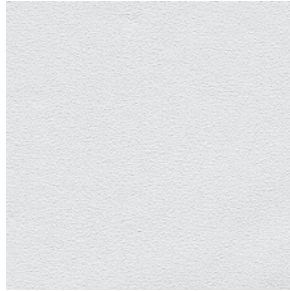

Concord (1/2")
7773-7771

Product Number	Name	Per Carton		Service Level
		Sq. Ft.	Pcs	

Lay-in Square Edge Panels — for 15/16" or 9/16" grid

Endure

1/2" x 24" x 24"

7773.01V	Concord	32	8	60	0
----------	---------	----	---	----	---

1/2" X 24" X 48"

7771.01 V	Concord	32	4	60	0
-----------	---------	----	---	----	---

Endure Plus - Sealed Edges for Clean Room Applications

1/2" x 24" x 24"

7874.01 V	Concord	32	8	65	4
-----------	---------	----	---	----	---

1/2" X 24" X 48"

7871.01 V	Concord	32	4	60	4
-----------	---------	----	---	----	---

Product Number	Product Description	Service Level
----------------	---------------------	---------------

Edge Sealant - For Endure Plus panels

7870.00	Blue - Quart Container	4
---------	------------------------	---

Soft Touch™ Vinyl

5/8" Vinyl/Fiberglass Laminated Panels



Coral
7013-7010



Cyprus
7023-7020



CAPRI
7043-7040

Soft Touch™ Plus

1" & 3" Vinyl/Fiberglass Laminated Panels



Coral
7113-7110-7111
7116-7114-7115



Cyprus
7123-7120-7121
7126-7124-7125



Capri
7143-7140-7141
7146-7144-7145



Chateau (3" Only)
7139-7137

Soft Touch™ Nubby

5/8", 1" & 1-1/2" Fabric/Fiberglass Laminated Panels



Nubby
75XX.xxN

Soft Touch™ Sierra™

3/4" & 1" Fabric/Fiberglass - Fabric/Mineral Laminated Panels



F (1")
7551-7552-7553

M (3/4")
7561-7562-7563

Product Notes:

- Adders:
- Product sold in full cartons only.
 - Foil backing - Service Level add 2 weeks.
 - Sealed edges Service Level add 2 weeks.



Coral
7013-7010



Cyprus
7023-7020



CAPRI
7043-7040

Product Number	Name	Per Carton			Service Level
		Sq. Ft.	Pcs	Weight	

Lay-in Square Edge Panels — for 9/16" or 15/16" grid

Non-Perforated

5/8" x 24" x 24"

7013.01F	Coral	96	24	16.5	3
7023.01F	Cyprus	96	24	24.0	3
7043.01F	Capri	96	24	32.0	3

5/8" X 24" X 48"

7010.01F	Coral	96	12	16.5	0
7020.01F	Cyprus	96	12	16.5	0
7040.01F	Capri	96	12	16.5	0

Perforated

5/8" x 24" x 24"

7013M01F	Coral	96	24	16.5	3
7023M01F	Cyprus	96	24	24.0	3
7043M01F	Capri	96	24	32.0	3

5/8" X 24" X 48"

7010M01F	Coral	96	12	16.5	3
7020M01F	Cyprus	96	12	16.5	3
7040M01F	Capri	96	12	16.5	3



Coral
7113-7110-7111
7116-7114-7115



Cyprus
7123-7120-7121
7126-7124-7125



Capri
7143-7140-7141
7146-7144-7145



Chateau (3" Only)
7139-7137

Product Number	Name	Per Carton			Service Level
		Sq. Ft.	Pcs	Weight	

Lay-in Square Edge Panels — for 9/16" or 15/16" grid
Non-Perforated

1" x 2' x 2'

7113.01F	Coral	96	24	33	3
7123.01F	Cyprus	96	24	33	3
7143.01F	Capri	96	24	33	3

1" X 2' X 4'

7110.01F	Coral	96	12	33	3
7120.01F	Cyprus	96	12	33	3
7140.01F	Capri	96	12	33	3

3" X 2' X 2'

7139.01F	Chateau	32	8	32	3
----------	---------	----	---	----	---

3" X 2' X 4'

7137.01F	Chateau	32	4	32	3
----------	---------	----	---	----	---

Perforated

1" x 2' x 2'

7113M01F	Coral	96	24	33	3
7123M01F	Cyprus	96	24	33	3
7143M01F	Capri	96	24	33	3

1" X 2' X 4'

7110M01F	Coral	96	12	33	3
7120M01F	Cyprus	96	12	33	3
7140M01F	Capri	96	12	33	3

3" X 2' X 2'

7139M01F	Chateau	32	8	32	3
----------	---------	----	---	----	---

3" X 2' X 4'

7137M01F	Chateau	32	4	32	3
----------	---------	----	---	----	---



Nubby
75XX.01N

Product Number	Name	Sq. Ft.	Per Carton Pcs	Weight	Service Level
----------------	------	---------	----------------	--------	---------------

Lay-in Square Edge Panels — for 9/16" or 15/16" grid

5/8" x 24" x 24"

7508.01N	Nubby	128	32	32	3
----------	-------	-----	----	----	---

5/8" X 24" X 48"

7509.01N	Nubby	128	16	32	3
----------	-------	-----	----	----	---

1" X 24" X 24"

7510.01N	Nubby	96	24	34	3
----------	-------	----	----	----	---

1" X 24" X 48"

7511.01N	Nubby	96	12	34	3
----------	-------	----	----	----	---

1" X 48" X 48"

7512.01N	Nubby	192	12	67	3
----------	-------	-----	----	----	---

1" X 48" X 96"

7513.01N	Nubby	192	6	67	3
----------	-------	-----	---	----	---

1" X 30" X 30"

7515.01N	Nubby	75	12	27	3
----------	-------	----	----	----	---

1" X 20" X 60"

7517.01N	Nubby	100	12	35	3
----------	-------	-----	----	----	---

1" X 30" X 60"

7502.01N	Nubby	150	12	52	3
----------	-------	-----	----	----	---



**NUBBY
75XX.01N**

Product Number	Name	Per Carton			Service Level
		Sq. Ft.	Pcs	Weight	

Lay-in Square Edge Panels — for 9/16" or 15/16" grid

1-1/2" X 24" X 24"

7520.01N	Nubby	64	16	34	3
----------	-------	----	----	----	---

1-1/2" X 24" X 48"

7521.01N	Nubby	64	8	34	3
----------	-------	----	---	----	---

1-1/2" X 48" X 48"

7522.01N	Nubby	128	8	67	3
----------	-------	-----	---	----	---

1-1/2" X 48" X 96"

7524.01N	Nubby	128	4	67	3
----------	-------	-----	---	----	---

1-1/2" X 30" X 30"

7525.01N	Nubby	100	16	52	3
----------	-------	-----	----	----	---

1-1/2" X 20" X 60"

7527.01N	Nubby	67	8	35	3
----------	-------	----	---	----	---

1-1/2" X 30" X 60"

7526.01N	Nubby	100	8	52	3
----------	-------	-----	---	----	---

1-1/2" X 60" X 60"

7523.01N	Nubby	200	8	104	3
----------	-------	-----	---	-----	---



7551-7552-7553

Product Number	Sq. Ft.	Per Carton Pcs	Weight	Service Level
----------------	---------	----------------	--------	---------------

Lay-in Square Edge Panels — for 9/16" or 15/16" grid

1" x 24" x 24"

7551.01F	96	24	34	3
----------	----	----	----	---

Lay-in Square Edge Panels — for 15/16" grid

1" x 24" x 24"

7552.01F	96	24	34	3
----------	----	----	----	---

Lay-in Square Edge Panels — for 9/16" grid

1" x 24" x 24"

7553.01F	96	24	34	3
----------	----	----	----	---



7561-7562-7563

Product Number	Sq. Ft.	Per Carton Pcs	Weight	Service Level
----------------	---------	----------------	--------	---------------

Lay-in Square Edge Panels — for 9/16" or 15/16" grid

3/4" x 24" x 24"

7561.01M	56	14	56	3
----------	----	----	----	---

Lay-in Square Edge Panels — for 15/16" grid

3/4" x 24" x 24"

7562.01M	56	14	56	3
----------	----	----	----	---

Lay-in Square Edge Panels — for 9/16" grid

3/4" x 24" x 24"

7563.01M	56	14	56	3
----------	----	----	----	---

General Conditions of Sale

Order Acceptance

Whenever used herein, "Seller" shall refer to Chicago Metallic Corporation and "Purchaser" shall refer to the party ordering or purchasing products ("Products") from Seller.

Seller's price list does not constitute an offer to sell Products listed therein, but is simply provided as a convenience to prospective Purchasers.

Purchaser's order to Seller shall constitute an offer to Seller to purchase Products which offer Seller may accept at its sole discretion. Acceptance shall be by a writing containing these General Conditions of Sale ("Conditions"). Acceptance of Purchaser's order or any part of it by Seller is expressly made conditional on Purchaser's assent to these Conditions. Purchaser may vary these Conditions only with the written consent of Seller. Acceptance of Products by Purchaser or failure of Purchaser to object in writing to these Conditions within ten (10) days following delivery of Products to Purchaser shall constitute Purchaser's assent to these Conditions.

Shipment and Delivery

Seller shall deliver Product F.O.B. place of shipment. Risk of loss to Product shall pass to Purchaser upon delivery to carrier at such place of shipment. Carrier acts as Purchaser's agent. Products shall be shipped as soon as practical, or as requested by Purchaser after order acceptance by Seller. However, delivery dates shall not be of the essence, but shall be regarded as Seller's best approximation of such delivery dates.

Prices of Freight Costs

Unless otherwise indicated, prices shown on Seller's price list are for less than truckload quantities. The minimum truckload quantity is 24,000 pounds. Prices are subject to change without notice and are based on full carton quantities. Prices shall be those in effect at time of shipment of Products.

Seller shall grant Purchaser a freight allowance on all orders of 12,000 pounds or more for a single shipment to a single destination. The allowance shall be based on the lowest rates currently in effect from actual shipping point to destination point or nearest port of export. In no event shall the allowance be greater than the actual freight cost of a specific shipment. Purchaser's request for costlier means of shipment will be honored, but Purchaser shall be liable to Seller for the additional freight expense. Purchaser "will-call" orders at Seller's plant warehouse shall not be entitled to allowance.

All taxes, tariffs, duties or similar charges paid by Seller imposed or levied by any governmental authority in connection with the purchase, shipment, import or export of Products purchased or in connection with the procuring of materials used therein may at Seller's sole option be added to the price of Products so affected. Additional shipping charges for Products paid by Seller such as destination, storage, labor and redelivery and special or extra expenses for handling air freight, bus or other shipments may also, at Seller's sole option, be added to the price of such Products.

Payment

Payment for all Products shall be net cash due and payable in U.S. dollars within thirty (30) days following receipt by Purchaser of shipping documents for such Products by check or bank transfer to a bank account to be designated by Seller. If accounts are paid within ten (10) days following receipt by Purchaser of the corresponding shipping documents, Purchaser shall be entitled to a one percent (1%) discount from the price of Products only.

If, in Seller's sole opinion, the financial condition of the Purchaser so warrants, Seller may require advance payments or satisfactory security. In the event that the Purchaser fails to make such advance payments or furnish such security upon Seller's request, delivery of Products may be suspended without further Seller obligation.

Seller may, at Seller's sole option, require payment by means of an irrevocable letter of credit opened and confirmed by a bank or banks acceptable to Seller and upon terms and conditions acceptable to Seller.

Limited Warranty

Seller warrants to Purchaser that Products will substantially conform in quantity and quality to Purchaser's order, as accepted by Seller, provided, however, that (1) Products are inspected by Purchaser upon arrival at place of destination and any and all nonconformities are noted on the bill of lading and all other delivery documents and are attested to in writing by carrier's representative (2) Purchaser furnishes Seller with written notice of such non-conformities within fifteen (15) days following arrival of non-conforming Products at the place of destination, (3) Pur-

chaser holds nonconforming Products for Seller's inspection (4) non-conformities occurred prior to delivery by Seller of Products F.O.B. place of shipment, and (5) Purchaser does not alter, repair, use or attempt to alter or repair any non-conforming Products. This limited warranty is Seller's only and exclusive express warranty to Purchaser. Seller disclaims any and all implied warranties including without limitation any implied warranty of merchantability or fitness for a particular purpose.

Purchaser's sole and exclusive remedy against Seller shall be the replacement F.O.B. its plant or site, at Seller's option, of any Products which do not conform to Seller's limited warranty hereunder. No other remedy (including, without limitation, incidental or consequential damages for lost profits, lost sales, injury to persons or property or any other incidental or consequential loss) shall be available to Purchaser.

Purchaser agrees to include in all contracts between Purchaser and subsequent owners or users of Products, and to bring to the attention of all Purchaser's customers of Products, the following warranty disclaimer: Chicago Metallic Corporation disclaims any and all warranties expressed or implied, including, without limitation, any implied warranty of merchantability or fitness for a particular purpose. Purchaser shall be excluded on behalf of Seller all remedies for damage or injury to Products persons or property. In the event that Purchaser fails to comply with the foregoing obligations, Purchaser shall indemnify Seller for any liability resulting from such non-compliance and shall otherwise hold Seller harmless.

Returns

In order to return any Products to Seller, Purchaser must first obtain prior authorization for products eligible for return, and receive a Return Goods Authorization number from Seller's home office. All authorized returns are subject to a 20% restocking charge. Seller will only issue credit for Service Level "0" material received at the designated company facility with the Return Goods Authorization appearing on the material, and after being inspected and determined by Seller to be in resalable condition. Purchaser is solely responsible for arranging and prepaying for all return freight. Seller will not be responsible for any damage in transit on material returned at customer's request, and will not file freight claims on such damaged material. When these terms are met, seller will issue appropriate material credit less the restocking charge.

Default, Termination and Suspension of Delivery

Seller reserves the right, among other remedies, either to cancel Purchaser's order or suspend further deliveries of Products thereunder in the event that (1) Purchaser fails to pay for any one shipment of Products when payment for such shipment becomes due; (2) Purchaser fails to make any advance payments or satisfactory security demanded by Seller pursuant to paragraph two of PAYMENTS section above; or (3) Purchaser fails or refuses to accept any delivery of Products ordered from Seller.

Delivery of Products may be suspended in whole or in part in case of any event beyond Seller's control, including, but not limited to, explosion, fire, shortage of fuel, power or raw materials flood strike lockout, injunction, riot, insurrection, war, national emergency, government act, or act of God.

Miscellaneous

No failure or delay on the part of Seller in exercising any right, power or privilege hereunder shall operate as a waiver thereof or of any other right, power or privilege hereunder nor shall any single or partial exercise of any such right power or privilege preclude any other right, power or privilege. The rights or remedies of Seller hereunder are cumulative and not exclusive of any rights or remedies which it may otherwise have.

The parties hereto may correct stenographic and clerical errors without liability.

Purchaser may not assign the order without the express written consent of Seller.

All notices to be given hereunder by either party to the other party shall be dispatched by certified or registered mail return receipt requested addressed to the last known post office address of such other party. Any such notice shall be deemed received within five (5) days following any such dispatch if mailed from within the United States of America and ten (10) days if mailed from outside the United States of America. Either party may change its address by notice to the other party.

These Conditions shall be governed by and interpreted in accordance with the laws of the State of Illinois, United States of America, and all disputes hereunder that cannot be amicably resolved by the parties thereto must be settled in a court of competent jurisdiction within the State of Illinois, United States of America.

The provisions of these Conditions shall be severable one from the other so that should any provision be held legally unenforceable by a court of competent jurisdiction, the remaining provisions shall remain in effect.



Chicago Metallic®

Ceiling Systems and Specialty Products - USA and Canada: 800.323.7164 / Fax: 800.222.3744 / chicagometallic.com

CHICAGO / BALTIMORE / LOS ANGELES / BELGIUM / DENMARK / THE NETHERLANDS / UK / GERMANY / FRANCE / HONG KONG / PRC / MALAYSIA / UNITED ARAB EMIRATES / MEXICO

Chicago Metallic and its logo are Registered Trademarks of Chicago Metallic Corporation.

© 2005 Chicago Metallic Corporation All Rights Reserved C-UTIL-072005 Printed in USA

Literature Disclaimer: Presentations in this brochure or any other Chicago Metallic Corporation publication are correct to the best of our knowledge at time of preparation. We provide this information in an advisory capacity only. Any advisory recommendations given in our publications must be modified to conform with local codes, conditions and specifications. We reserve all rights to amend any information published in our literature without additional notice. Chicago Metallic can not be held responsible or liable for the selection nor application of our products.