

Sheetrock®

USG

interior
finishing
products

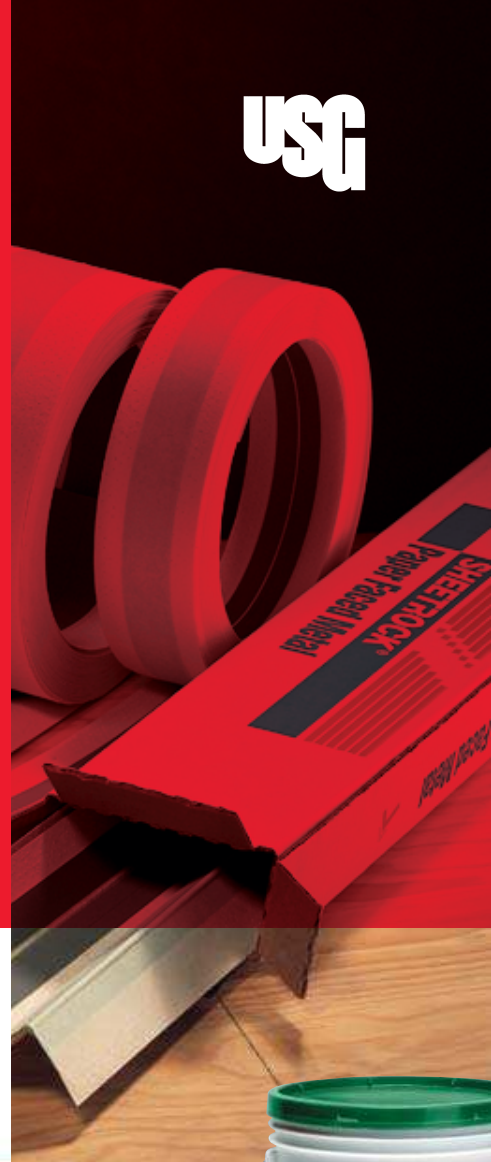
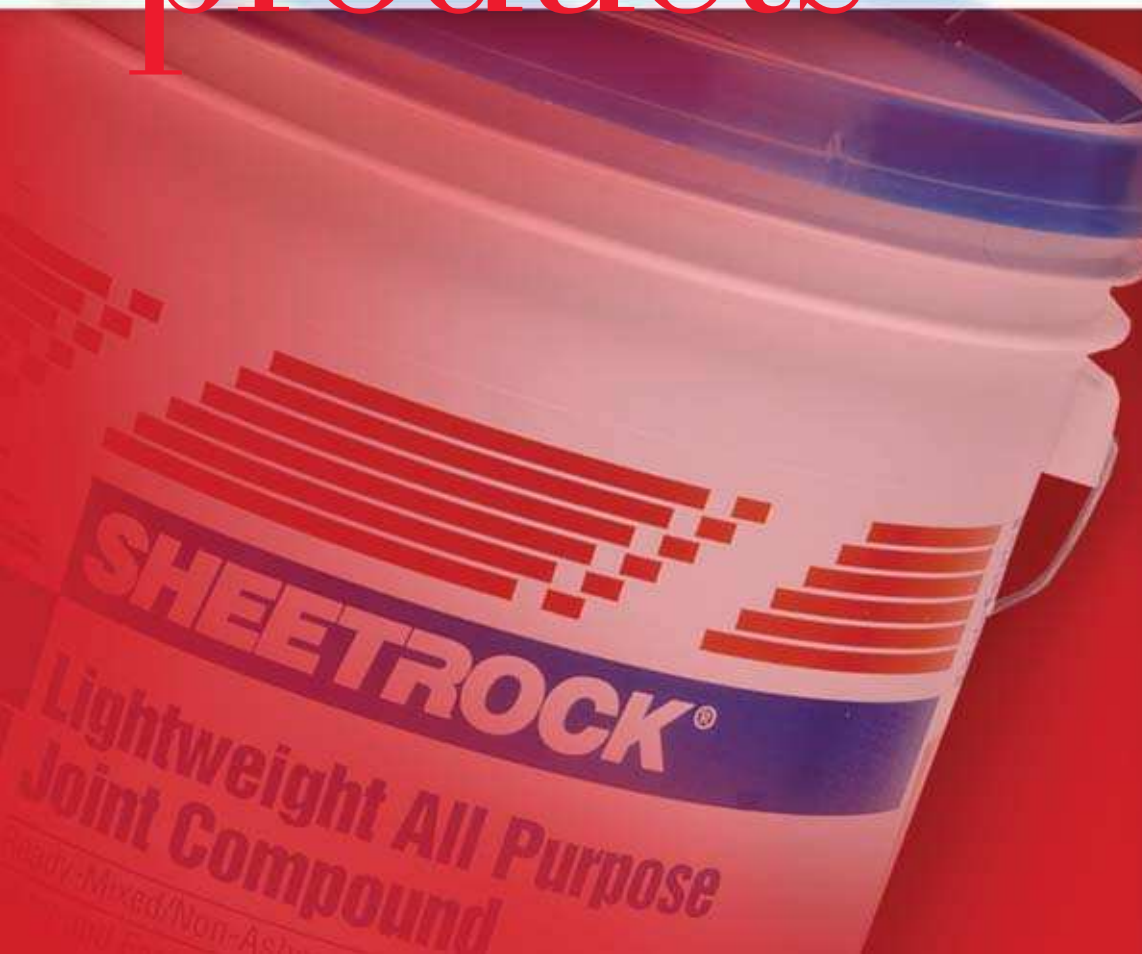

To ensure the beauty and integrity of your drywall interior, rely on top-quality finishing systems from USG.

We offer a complete line of interior finishing products, from joint compounds and tape to decorative textures, primer, bead, drywall clips and repair kits – all from the name you trust







Joint Compounds

Each product line within the SHEETROCK® brand interior finishing family contains the variety you need to accomplish any interior finishing task.

Our complete line of joint compounds is one example. Whether you are taping, applying a finish coat, or patching a crack, there is a SHEETROCK product to meet your needs. Each of our joint compounds also offers special features, such as high humidity resistance or texturing capability.

Our joint compounds are available in ready-mixed drying-type versions, and as both setting-type and drying-type powders.

Ready-Mixed Joint Compounds

<p>SHEETROCK® Joint Compound PLUS 3™ Lightweight All Purpose</p> 	<ul style="list-style-type: none"> – Weighs up to 35% less than conventional joint compounds. – Very low shrinkage—only two coats needed over metal. – Sands more easily than conventional compounds. – Excellent for hand and mechanical tool application. 	<p>SHEETROCK® Joint Compound PLUS 3™ with Dust Control Lightweight All Purpose</p> 	<ul style="list-style-type: none"> – Less airborne dust. – Unique “heavy dust” particles simplify cleanup. – Very low shrinkage. – Weighs up to 35% less than conventional joint compounds.
<p>SHEETROCK® Joint Compound Taping</p> 	<ul style="list-style-type: none"> – Great for embedding tape. – Excellent bond and crack resistance. – Best ready-mixed material for laminating. 	<p>SHEETROCK® Joint Compound Topping</p> 	<ul style="list-style-type: none"> – Low shrinkage; ideal as second and third coats. – Easy to apply and sand; smooth finishing.
<p>SHEETROCK® Joint Compound MIDWEIGHT™ All Purpose</p> 	<ul style="list-style-type: none"> – Ready-mixed convenience. – Weighs up to 15% less than conventional-weight compounds. – Easy working and sanding. – Low shrinkage. 	<p>SHEETROCK® Joint Compound All Purpose</p> 	<ul style="list-style-type: none"> – Versatile performer: tape, finish, texture, laminate, or skim coat. – Good for taping and topping. – Ideal for repairing plaster cracks.

Joint Compounds

Setting-Type Powder Joint Compounds

SHEETROCK® Joint Compound DURABOND® Setting-Type



- Choice of setting times: 20, 45, 90, 210.
- Exceptional bond with low shrinkage.
- Same-day finishing and next-day decorating possible.
- Excellent check-crack resistance in heavy fills.
- Unique resistance to humidity.
- 25 lb. bag.

SHEETROCK® Joint Compound EASY SAND™ Lightweight Setting-Type



- Choice of setting times: 5, 20, 45, 90, 210.
- Weighs 25% less than conventional setting-type compounds.
- Easy sanding—similar to ready-mixed, all-purpose compound.
- Provides excellent bond, low shrinkage, humidity resistance, and check-crack resistance.
- Easy to mix.
- 18 lb. bag, 4 lb. box.

Drying-Type Powder Joint Compounds

SHEETROCK® Joint Compound



Taping

- For embedding tape and first fill coat on metal.
- Perfect for patching plaster cracks.
- Superior bond and resistance to cracking.

Topping

- Smooth-sanding for finish coats.
- Low-shrinkage and excellent feathering properties.
- Provides superior finishing results.

All Purpose

- An all-around performer for drywall finishing.
- Good taping and topping in one product.
- Also use for texturing.

All products available in 25 lb. bag.

SHEETROCK® Joint Compound AP Lite™ Lightweight All Purpose



- Weighs 20% less than conventional compounds.
- Lower shrinkage, better crack-resistance.
- Easier mixing, application, sanding.
- 20 lb. bag.

Drywall Joint Tapes

SHEETROCK® Joint Tape



- Superior center creasing for trouble-free corner finishing.
- High-strength to resist tearing, stretching, wrinkling.
- Processed for superior bond.
- Wafer-thin for easy joint treatment.
- 75, 250 and 500 ft. rolls.

SHEETROCK® Fiberglass Drywall Tape



- Self-adhesive tape—no bedding coat needed.
- Smooth joints in only two coats.
- Use with setting-type joint compounds for one-day joint finishing.
- 75 and 250 ft. rolls.

Flexible Metal Tape-On Corner

Tape-On Flexible Outside and Inside Corner Bead

SHEETROCK™ Flex Metal Tape, Tape-On Flexible Corner (Flex Tape)

Can be formed to fit any inside or outside angle. Available in 2-1/16" width that has two 7/16" wide galvanized rust-resistant steel strips with a 1/16" gap between the strips. For maximum strength and coverage, the tape is also available in a 4" width that has two 7/8" wide galvanized steel strips with a 1/16" gap between the strips. Product is suitable for any thickness of wallboard. Available in 100' rolls.

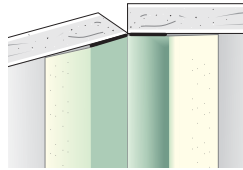

Style	Dimensions			
	A	B	C	D
Flex Tape (2-1/16")	9/16"	7/16"	7/16"	9/16"
Flex Tape (4")	1-1/8"	7/8"	7/8"	1-1/8"

variable
45°-180°

variable
45°-180°

SHEETROCK™ B1 Flex Metal Corner, Tape-On Outside Flexible Corner (B1 Beaded Flex)

Patented style designed specifically to make straight, strong outside corner angles. Available in 3" width and manufactured with two 3/4" galvanized steel strips laminated to paper tape with a flexible gap between the strips. B1 beaded flex has a unique raised bead (nose) in the flexible gap to provide faster, easier finishing with joint compound. For use on any wallboard thickness. Standard lengths: 8', 9', 10'.

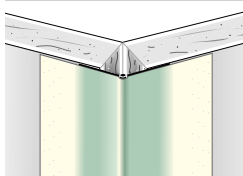

Style	Dimensions			
	A	B	C	D
B1 Beaded Flex (3")	11/16"	3/4"	3/4"	11/16"

variable
45°-180°

SHEETROCK™ B2 Flex Metal Tape, Tape-On Inside Flexible Corner (B2 Flex)

Designed specifically to make straight, strong inside corners of any angle. Ideal for vaulted ceiling angles and vertical inside angles. Available in a 4" width that has two 7/8" galvanized steel strips with no gap between the strips. Placing the steel strips together, along with the extra wide paper width, results in extra strength and rigidity for straighter and truer finished inside angles. Available in 100' rolls.

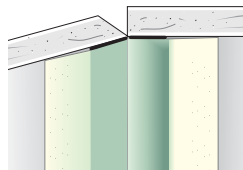

Style	Dimensions			
	A	B	C	D
B2 Flex (4")	1-1/8"	7/8"	7/8"	1-1/8"

variable
45°-180°

Primer Surfacer

SHEETROCK® Primer-Surfacer TUFF-HIDE™



- Use in lieu of skim coat and primer coat in a Level 5 gypsum board finish.
- Minimizes callbacks caused by joint banding and photographing.
- Installed cost savings versus traditional separate applications of skim coat and a prime coat.
- Durable coating hides minor surface defects.
- 5 gal. pail.

Primers

SHEETROCK® Primer First Coat



- Ideal primecoat for interior gypsum board and concrete surfaces.
- Equalizes surface absorption and texture variations of substrate to minimize decorating problems.
- Apply with brush, roller, or spray equipment.
- Dries white in less than 30 minutes—topcoat in an hour.
- 1 and 5 gal. pails.

SHEETROCK® Wallcovering Primer



- Prepares and seals most wall surfaces for decoration.
- Permits later removal of wallpaper.
- Dries quickly to a smooth working surface.
- 5 gal. pails.

Firestopping

<p>FIRECODE® Compound</p> 	<ul style="list-style-type: none"> – For use in providing firestop systems for floor and wall penetrations and head-of-wall construction joints. – Nontoxic; flame spread 0, smoke developed 0 when tested per ASTM E84. UL-labeled compound. – Mixes quickly with water. – Complies with ASTM E814, CAN 4-S115, and UL 2079. Recognized by ICBO (ER-5050). – 15 lb. bag. 	<p>FIRECODE® Firestop Sealant Acrylic</p> 	<ul style="list-style-type: none"> – Material remains flexible after it dries. – Single-component, water-based, acrylic sealant. – Effective in numerous UL systems for wall and floor through-penetrations and head-of-wall construction joint applications in USG™ Firestop Systems. – Complies with ASTM E814, UL 2079, and CAN 4-S115.
<p>FIRECODE® Firestop Sealant Intumescent Acrylic</p> 	<ul style="list-style-type: none"> – Material expands when heated to fill any voids caused from combustible materials burned or melted during a fire; for example, penetrations with plastic or insulated pipe. – Material remains flexible after it dries. – Single-component, water-based, acrylic sealant. – Effective in numerous UL systems for wall and floor through-penetration applications. – Complies with ASTM E814 and CAN 4-S115. 	<p>FIRECODE® Firestop Sealant Acrylic Spray</p> 	<ul style="list-style-type: none"> – Sprayable material remains flexible after it dries. – Single-component, water-based, acrylic sealant – Effective in UL systems for head-of-wall construction joint applications – Complies with ASTM E1966 UL 2079, and CAN 4-S115.

Sound Control

<p>SHEETROCK™ Acoustical Sealant</p> 	<ul style="list-style-type: none"> – Special caulking for reducing sound transmission in partition systems to achieve specified STC/MTC values. – Applies and adheres easily to most surfaces. – Highly elastic for permanent flexibility and seal. – Meets ASTM C834. – 29 oz. cartridge and 5 gal. pail. 	
---	---	--

Textures and Texture Paints

In addition to offering a variety of decorating options, interior textures from USG solve a number of practical problems. Our easy-to-apply textures conceal surface defects in walls and ceilings, while adding drama to your interior decor.

SHEETROCK® textures are provided in bright, attractive packaging that offer a number of benefits, including color-coding to facilitate product identification; names that clearly communicate where to use the product; and directions that are clear, concise, and easy to follow.

Products for brush, roller, and spray application are available.

<p>SHEETROCK® Ceiling Spray Texture QT Poly: Fine, Medium and Coarse</p>	<p>SHEETROCK® Wall and Ceiling Spray Texture Unaggregated</p>
	<ul style="list-style-type: none"> – For striking acoustical appearance on interior ceilings. – Ideal for new construction and for renewing old ceilings. – Hides minor surface defects with an attractive texture. – Choice of three high-style finishes. – Easy-pumping, low-cost spray application.
	<ul style="list-style-type: none"> – For a variety of light, appealing textures in interiors, including spatter and spatter/knockdown. – Superior open time for hand-tooled knockdown finishes. – Excellent surface relief (standout), low shrinkage. – Not washable unpainted—overpaint when dry.
<p>SHEETROCK® Wall and Ceiling Texture Tuf-Tex™</p>	<p>SHEETROCK® Wall and Ceiling Texture Multi-Purpose</p>
	<ul style="list-style-type: none"> – For diverse texture patterns from bold spatter/knockdown to light orange peel. – Conceals minor surface defects. – Spray, brush, or roller application. – Dries to a hard white finish—overpaint when dry.
	<ul style="list-style-type: none"> – Spray, brush, or roller applied. – For artistic variety of light texture effects on new drywall interiors. – Offers decorative versatility. – Conceals minor surface defects in walls, ceilings. – Not washable unpainted—should be overpainted when dry.

**SHEETROCK® Wall and Ceiling Spray Texture
Sand Finish Texture 12**



- For beautiful sand-finish plaster effect.
- Conceals minor surface defects in walls and ceilings.
- Designed for fast, low-cost spray application.
- Can be left unpainted on ceilings.

SHEETROCK® Wall and Ceiling Spray Texture



- Spray texture with ready-mixed convenience.
- For a variety of light, appealing textures in interiors, such as spatter, spatter/knock-down, and orange peel.
- Excellent surface relief (standout); low shrinkage.
- Not washable unpainted—overpaint when dry.

**SHEETROCK® Wall and Ceiling Texture Paint
TEXOLITE™ Sanded Paste Stipple**



- Provides a fine, light sand finish.
- Latex formula dries to a durable, natural white finish.
- Conceals minor surface defects.
- Spray, brush or roller applied.

**SHEETROCK® Wall and Ceiling Texture Paint
Sand Finish Texture 1**



- For producing a light sand finish with light-bodied under-texture.
- Versatile application—applies easily with brush, roller or spray equipment.
- Quick-drying—shortens decorating time, reduces overall costs.
- Interior white latex.

SHEETROCK™ Sand Finish Paint Additive (8 oz. pail and 30. oz. box)



- For creating textured walls and ceilings.
- Also ideal for creating a non-skid surface on decks, steps, etc.
- Works in all paints and varnishes—oil-based or latex-based, interior or exterior.
- Amount used can be varied to provide a customized texture.
- Remains suspended during application to ensure a uniform finish.
- 8 oz. pail and 30. oz. box.

Patch and Repair

<p>SHEETROCK® Plaster of Paris</p> 	<ul style="list-style-type: none"> – For patching interior dry-wall and plaster walls and ceilings. – Sets hard in 30 minutes. – Can also be used for casting, modeling and sculpting forms. – 4 and 8 lb. boxes; 25 lb. bag. 	<p>SHEETROCK™ Floor Patch/Leveler</p> 	<ul style="list-style-type: none"> – Ideal for filling and leveling floor substrates. – Easy to apply. – Sets quickly. – Creates a strong, durable patch. – 25 lb. bag.
<p>SHEETROCK™ Spackling Powder</p> 	<ul style="list-style-type: none"> – Ideal for interior plaster repairs. – Non-shrinking. – Fast setting, easy sanding. – Easy to mix formulation. – 4 lb. box. 	<p>SHEETROCK® Patching Plaster</p> 	<ul style="list-style-type: none"> – For interior plaster repairs. – Non-shrinking and slow setting. – Easy to sand. – Can be drilled, textured, and painted. – 4 lb. box and 25 lb. bag.
<p>SHEETROCK® Drywall Repair Clips</p> 	<ul style="list-style-type: none"> – Fast, easy repair. – Use for large holes (over 2") and areas damaged by water. – When used with fire-rated drywall, meets building code requirements for repairing one-hour fire-rated drywall partitions. – Suitable for both 1/2" and 5/8" drywall. – 6 clips, 12 drywall screws. 	<p>SHEETROCK® Patch and Repair Pack PLUS 3"</p> 	<ul style="list-style-type: none"> – For fixing small holes and cracks in interior drywall and plaster walls and ceilings. – Shrinks less for fewer coats. – Lightweight formula. – Convenient, re-sealable compound pan that includes 3-1/2" plastic application knife.

SHEETROCK® Drywall Repair Kit



- 4 drywall repair clips,
- 8 drywall screws.
- Plastic spreader
- 1-7/8 in. x 5 ft. SHEETROCK® fiberglass drywall tape.
- 1/2 lb. EASY SAND™ 90 setting compound.
- 2 sheets 120-grit sandpaper,
- 4 in. x 5-1/2 in.
- Instruction sheet.

SHEETROCK™ Joint Compound Lightweight Touch-Up



- Vinyl-based compound for touch-up repair of hairline cracks, small holes and other minor imperfections in the finishing of gypsum wallboard panels.
- Lightweight formula provides low shrinkage and easy sanding performance.
- Packaged in convenient cartridge for fast caulking gun application.
- Offers all the advantages of a quality SHEETROCK® ready-mixed joint compound.

Concrete Finishing

COVER COAT® Compound



- For filling and smoothing monolithic concrete ceilings and columns located above grade.
- Easily applied—no extra bonding agent needed.
- Dries to a fine white decorative surface.
- Also ideal for drywall tape embedding and first coat over bead.
- 61.7 lb. carton and pail.

Paper Faced Metal Bead and Trim

For the most cost-effective, problem-free, beautiful corners, the logical choice is SHEETROCK™ paper faced metal bead and trim. Fast, easy installation means reduced labor costs, while superior product performance eliminates costly job callbacks, saving money and ensuring customer satisfaction. With the tape-on versions, nailing is not required, so installation and corner alignment are easier, and there are no nails to pop when wood framing shrinks. The paper tape covering ensures excellent adhesion of joint compounds, textures, and paints for a strong, smooth finish.

SHEETROCK paper faced metal bead and trim provides superior resistance to edge cracking and chipping for a look that stays beautiful despite the stresses of normal building movement and everyday wear and tear. In fact, USG warrants that SHEETROCK paper faced metal tape-on bead and trim will not edge crack for the lifetime of the structure using recommended application techniques (refer to USG Lifetime Warranty J1302 for details). The unique “nose coating” on the paper tape covering resists scuffing and fuzzing from knives and sanding.

Nail-on versions of the bead and trim are designed for applications where nailing or other mechanical fastening is desired. They use the same paper-faced metal technology to provide excellent bond adhesion qualities for joint compounds, textures and paints.

90° and Offset Outside Corner Bead

SHEETROCK™ Paper Faced Metal Outside Corner, Tape-On Bead (B1W, B1XW, B1 Super Wide)

Use for 90° outside corners. Suitable for use on any thickness of wallboard. Standard lengths: 8', 9', 10'.

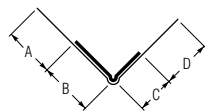
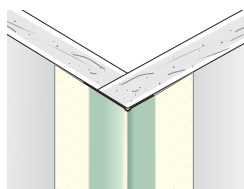

Style	Dimensions			
	A	B	C	D
B1W	3/4"	13/16"	9/16"	3/4"
B1W NB	3/4"	13/16"	9/16"	3/4"
B1XW	5/8"	15/16"	11/16"	5/8"
B1XW EL	5/8"	13/16"	13/16"	5/8"
B1XW NB	5/8"	15/16"	11/16"	5/8"
B1XW ELNB	5/8"	13/16"	13/16"	5/8"
B1 Super Wide	1 1/16"	1 1/16"	1 1/16"	1 1/16"

Note: XW = Extra Wide; EL = Even Leg; NB = No Bead.

SHEETROCK™ Paper Faced Metal Outside Corner, Tape-On Bead (Micro Bead)

Designed with a wider 1" by 1" profile that's easier to install on all cut edges. Reduced bead height results in less use of joint compound. In most cases, reduces the amount of compound needed by one coat. Standard lengths: 8', 9', 10'.

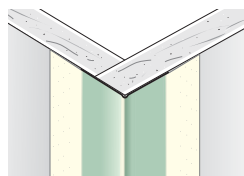

Style	Dimensions			
	A	B	C	D
Micro Bead	3/4"	1"	1"	3/4"

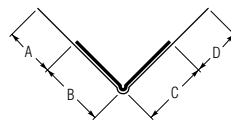

SHEETROCK™ Paper Faced Metal Offset Outside Corner, Tape-On Bead (B1 OS)

Designed for 135° corners. Offset bead is designed to give a true offset corner with a smaller bead height requiring less compound to finish. Can be used on any thickness of wallboard. Standard lengths: 8', 9', 10'.

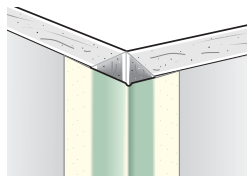

Style	Dimensions			
	A	B	C	D
B1 OS	5/8"	3/4"	1/2"	5/8"

Note: OS = Offset

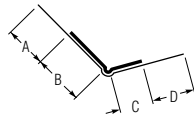

SHEETROCK™ Paper Faced Metal Outside Corner, Nail-On Bead (Ultra Bead)

Use for applications where nailing or other mechanical fastening is required. Has wider flanges for easier nailing and maximum corner coverage. Can be fastened to 1/2" or 5/8" drywall with nails, staples, or screws. Standard lengths: 8', 9', 10'.

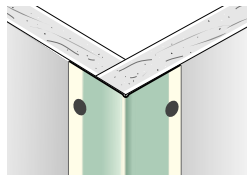

Style	Dimensions	
	A	B
Ultra Bead	1-1/4"	1-1/4"

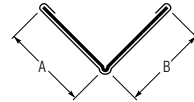

90° and Offset Inside Corner

SHEETROCK™ Paper Faced Metal Inside Corner, Tape-On Trim (B2)

Designed to form a true inside (90°) corner. For use with any thickness of wallboard. Standard lengths: 8', 9', 10'.

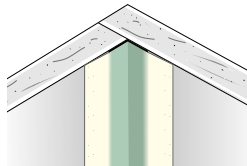

Style	Dimensions			
	A	B	C	D
B2	5/8"	3/8"	3/8"	5/8"

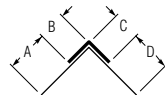

SHEETROCK™ Paper Faced Metal Offset Inside Corner, Tape-On (B2 OS)

Designed for a 135° offset angle on inside corners greater than 90°. For use on any thickness of wallboard. Standard lengths: 8', 9', 10'.

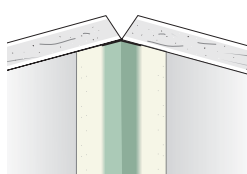

Style	Dimensions			
	A	B	C	D
B2 OS	5/8"	5/8"	5/8"	5/8"

Note: OS = Offset

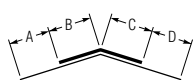

Paper Faced Metal Bead and Trim

Softline Bullnose and Offset Outside Corner Bead

SHEETROCK™ Paper Faced Metal 3/4" Bullnose Outside Corner, Tape-On Bead (SLOC)

Installs easily to form a smooth rounded outside corner. The 3/4" radius can be used for 1/2" or 5/8" drywall. Standard lengths: 8', 9', 10'.

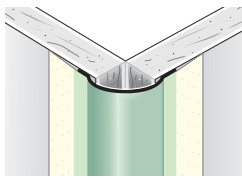

Dimensions			
Style	A	Radius	B
SLOC	5/8"	3/4"	5/8"

SHEETROCK™ Paper Faced Metal 3/4" Bullnose Offset Outside Corner, Tape-On Bead (SLOC OS)

Designed for 135° offset angles. Speeds application and eliminates need on framing members for fastening corners. Standard lengths: 8', 9', 10'.

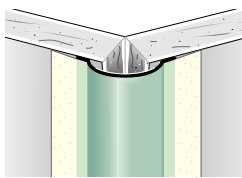

Dimensions			
Style	A	Radius	B
SLOC OS	3/4"	3/4"	3/4"

Note: OS = Offset

SHEETROCK™ Paper Faced Metal 1-1/2" Bullnose Outside Corner, Tape-On Bead (Danish)

Bead is similar to the SLOC series except for a 1-1/2" radius. Can be used for 1/2" or 5/8" drywall. Standard lengths: 8', 10'.

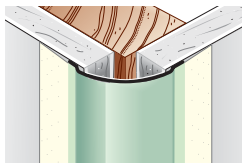

Dimensions			
Style	A	Radius	B
DANISH	3/4"	1-1/2"	3/4"

SHEETROCK™ Paper Faced Metal 1/2" Bullnose Outside Corner, Tape-On Bead (Baby Bull)

Provides a narrower finished look with a smaller radius compared to other bullnose profiles. Also, excellent for trimming around windows. Can be applied over new 1/2" or 5/8" thick drywall. Standard lengths: 8', 9', 10'.

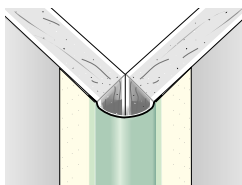

Dimensions			
Style	A	Radius	B
Baby Bull	5/8"	1/2"	5/8"

**SHEETROCK™ Paper Faced Metal
1/2" Bullnose Offset Outside Corner,
Tape-On Bead (Baby Bull OS)**

Narrower bullnose "look" designed for 135° outside corner offsets.
Standard lengths: 8', 10'.

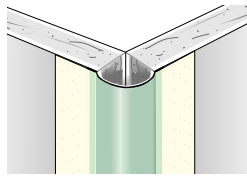

Style	Dimensions		
	A	Radius	B
Baby Bull OS	5/8"	1/2"	5/8"

Note: OS = Offset

**SHEETROCK™ Paper Faced Metal
3/4" Bullnose Outside Corner,
Tape-On Bead (Santa Fe)**

Provides economical alternative for bullnose corners. Suitable for use on any thickness of wallboard. Does not meet Standard ASTM C1047. Standard lengths: 8', 9', 10'.

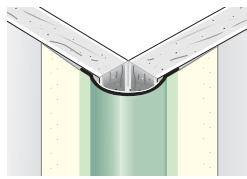

Style	Dimensions		
	A	Radius	B
Santa Fe	5/8"	3/4"	5/8"

**SHEETROCK™ Paper Faced Metal
3/4" Bullnose Outside Corner,
Nail-On Bead (SLOC N)**

Use for smooth, rounded corners where nailing or other mechanical fastening is required.
Can be fastened to 1/2" or 5/8" drywall with nails, staples, or screws.
Standard lengths: 8', 9', 10'.

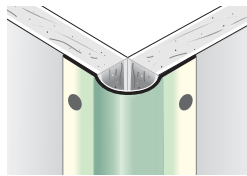

Style	Dimensions		
	A	Radius	B
SLOC N	5/8"	3/4"	5/8"

Note: N = Nail-On

**SHEETROCK™ Paper Faced Metal
3/4" Bullnose Outside Corner,
Nail-On Bead (SLOC NXW)**

Use for applications where nailing or other mechanical fastening is required. Has wider flanges for easier nailing and maximum corner coverage. Standard lengths: 8', 9', 10'.

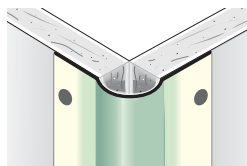

Style	Dimensions		
	A	Radius	B
SLOC NXW	7/8"	3/4"	7/8"

Note: NXW = Nail-On Extra Wide

Paper Faced Metal Bead and Trim

Softline Bullnose and Offset Outside Corner Bead

SHEETROCK™ Paper Faced Metal 3/4" Bullnose Offset Outside Corner, Nail-On Bead (SLOC NOS)

Use for applications where nailing or other mechanical fastening is required. Creates 135° offset outside corner. Standard lengths: 8', 9', 10'.

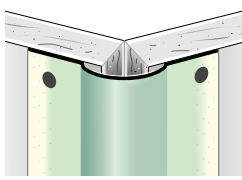

Dimensions			
Style	A	Radius	B
SLOC NOS	1-1/16"	3/4"	1-1/16"

Note: NOS = Nail-On Offset

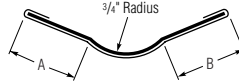

SHEETROCK™ Paper Faced Metal 1-1/2" Bullnose Outside Corner, Nail-On Bead (Danish N)

Forms a smooth, rounded corner similar to SLOC N but with a 1-1/2" radius. Use where nailing or other mechanical fastening is required. Can be fastened to 1/2" or 5/8" drywall with nails, staples or screws. Standard lengths: 8' and 10'.

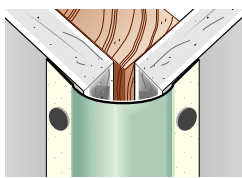

Dimensions			
Style	A	Radius	B
Danish N	3/4"	1-1/2"	3/4"

Note: N = Nail-On

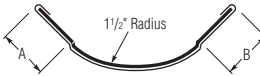

SHEETROCK™ Paper Faced Metal 1/2" Bullnose Outside Corner, Nail-On Bead (Baby Bull N)

Provides a narrower finished look with a smaller radius compared to other bullnose profiles. Also excellent for trimming around windows. Use where nailing or other mechanical fastening is required. Standard lengths: 8', 9', 10'.

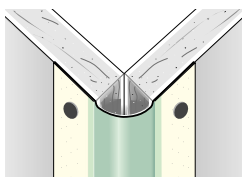

Dimensions			
Style	A	Radius	B
Baby Bull N	3/4"	1/2"	3/4"

Note: N = Nail-On

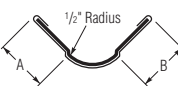

SHEETROCK™ Paper Faced Metal 3/4" Bullnose Outside Corner, Nail-On Bead (Santa Fe N)

Provides economical alternative for bullnose corners. Can be fastened to 1/2" or 5/8" drywall with nails, staples or screws. Does not meet Standard ASTM C1047. Standard lengths: 8', 9', 10'.

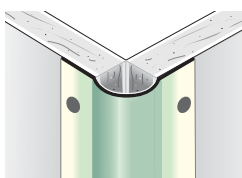

Dimensions			
Style	A	Radius	B
Santa Fe N	5/8"	3/4"	5/8"

Note: N = Nail-On

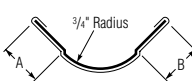

Softline Bullnose and Offset Inside Corners

SHEETROCK™ Paper Faced Metal 3/4" Bullnose Inside Corner, Tape-On (SLIC)

Use to create a smooth, rounded inside corner. The 3/4" radius trim is suitable for 1/2" or 5/8" drywall. Standard lengths: 8', 10'.

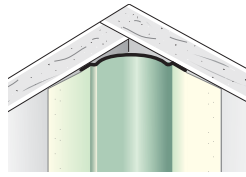

Style	Dimensions		
	A	Radius	B
SLIC	3/4"	3/4"	3/4"

SHEETROCK™ Paper Faced Metal 3/4" Bullnose Offset Inside Corner, Tape-On (SLIC OS)

Softline inside cover for 135° offset angles. Creates smooth rounded inside corner suitable for 1/2" or 5/8" drywall. Standard lengths: 8', 10'.

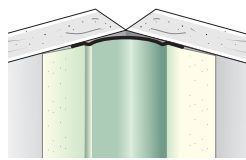

Style	Dimensions		
	A	Radius	B
SLIC OS	5/8"	3/4"	5/8"

Note: OS = Offset

L Trims

SHEETROCK™ Paper Faced Metal "L" Shaped, Tape-On Trim (B4 Series)

Use where wallboard abuts with suspended ceilings, beams, plaster, masonry, and concrete walls, as well as untrimmed door and window jambs. Standard lengths: 8', 9', 10'.

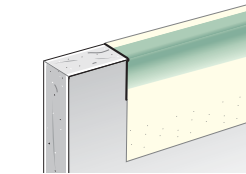

Style	Dimensions		
	A	B	C
B4 (3/8")	3/8"	7/8"	1"
B4 (1/2")	1/2"	15/16"	1-1/4"
B4 (5/8")	5/8"	13/16"	1-1/4"
B4 (1")	1"	15/16"	1-5/16"
B4 NB (3/8")	3/8"	7/8"	1"
B4 NB (1/2")	1/2"	15/16"	1-1/4"
B4 NB (5/8")	5/8"	13/16"	1-1/4"

Note: NB = No Bead

SHEETROCK™ Paper Faced Metal Premasked "L"-Shaped Tape-On Trim (Premasked L)

Provides a serrated paper strip that protects the adjacent surface of ceiling or wall intersection during finishing and decorating applications. Simply tear away the protective strip after the job is completed, leaving virtually no clean up to the adjacent surface. Standard lengths: 8', 10'.

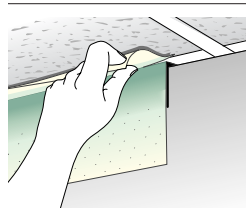

Style	Dimensions			
	A	B	C	D
Premasked "L" (1/2")	1/2"	15/16"	1-1/4"	1-3/4" tear off
Premasked "L" (5/8")	5/8"	13/16"	1-1/4"	1-3/4" tear off

Paper Faced Metal Bead and Trim

L Trims

**SHEETROCK™ Paper Faced Metal
“L” Shaped, Nail-On Trim (B8)**

B8 “L” Trim is a nail-on version of “L” trim. Paper face provides superior compound, paint, and texture adhesion, greatly reducing chipping. Standard lengths: 8’, 9’, 10’.

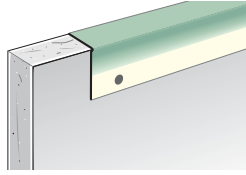

Style	Dimensions	
	A	B
B8 (3/8")	3/8"	7/8"
B8 (1/2")	1/2"	15/16"
B8 (5/8")	5/8"	13/16"

J Trims

**SHEETROCK™ Paper Faced Metal
“J” Shaped, Tape-On Trim (B9)**

Tape-on “J” trim completely surrounds the rough edge of the wallboard, providing a strong and clean corner. Tape-on application eliminates frustration with nailing and nail shrink back. Can be used for finishing off bi-fold closet doors, as well as under all door and window encasements, and to finish rough drywall ends. Standard lengths: 7’, 8’, 10’.

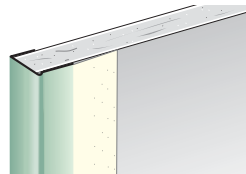

Style	Dimensions			
	A	B	C	D
B9J (1/2")	1/2"	9/16"	5/8"	1-1/16"
B9J (5/8")	1/2"	5/8"	9/16"	1-1/16"

Reveal Trims

**SHEETROCK™ Paper Faced Metal
Reveal, Tape-On Trim (Reveal NB)**

This modified tape-on “L” trim solves a variety of problems associated with reveal details on soffits, wall areas, ceilings, light boxes, and other interior architectural components. Reveal NB features a paper flange on both trim legs. The additional paper flange eliminates the need to caulk the edge of reveal details, providing a cleaner and straighter line. Available only in No Bead. Standard lengths: 8’, 10’.

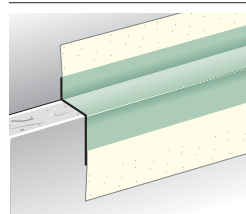

Style	Dimensions			
	A	B	C	D
Reveal NB (1/2")	15/16"	1/2"	1/2"	3/4"
Reveal NB (5/8")	15/16"	5/8"	5/8"	5/8"

Note: NB = No Bead

Metal Bead and Trim

Provides protection and neat finished edges for corners, gypsum panels at window and door jambs, ceiling angles and intersections where panels abut other materials.

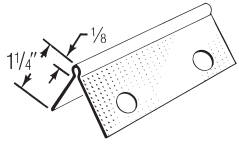
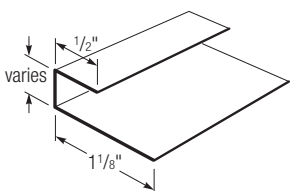
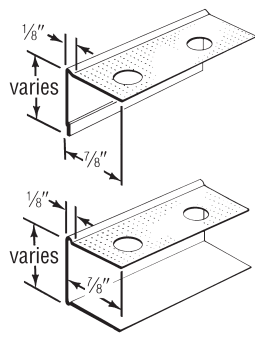
DUR-A-BEAD® Corner Bead		J-Stop	
	<p>Part of the family of SHEETROCK metal products. All-metal galvanized steel reinforcement, protects external corners. Concealed with United States Gypsum Company joint compounds for a smooth, finished corner. Available in flange width: No. 103 1-1/4" x 1/1/4".</p>		<p>Reveal type galvanized steel trim, requires no finishing compound, includes No. 401 in 1/2", No. 402 in 5/8" size.</p>
<p>L-Trim and J-Trim</p> 	<p>Galvanized steel casing, includes No. 200-A J-shaped channel in 1/2" and 5/8" sizes; No. 200-B L-shaped angled edge trim without back flange to simplify application, in 1/2" and 5/8" sizes.</p>		



Technical Service

800 USG.4YOU

Web Site

usg.com

Samples/Literature

888 874.2450

Samples/Literature E-mail

samplit@usg.com

Samples/Literature Fax

888 874.2348

Customer Service

800 950.3839

Product Information

See usg.com for the most up-to-date product information.

Note

Products described here may not be available in all geographic markets. Consult your U.S. Gypsum Company sales office or representative for information.

Trademarks

The following trademarks used herein are owned by United States Gypsum Company: A/P Lite, COVER COAT, DUR-A-BEAD, DURABOND, EASY SAND, FIRECODE, PLUS 3, MIDWEIGHT, SHEETROCK, TEXOLITE, TUF-TEX, TUFF HIDE.

Notice

We shall not be liable for incidental and consequential damages, directly or indirectly sustained, nor for any loss caused by application of these goods not in accordance with current printed instructions or for other than the intended use. Our liability is expressly limited to replacement of defective goods. Any claim shall be deemed waived unless made in writing to us within thirty (30) days from date it was or reasonably should have been discovered.

Safety First!

Follow good safety and industrial hygiene practices during handling and installation of all products and systems. Take necessary precautions and wear the appropriate personal protective equipment as needed. Read material safety data sheets and related literature on products before specification and/or installation.



Manufactured by
United States Gypsum Company
550 West Adams Street
Chicago, IL 60661

J1424/rev. 6-07
© 2007, United States Gypsum Company
Printed in U.S.A.