

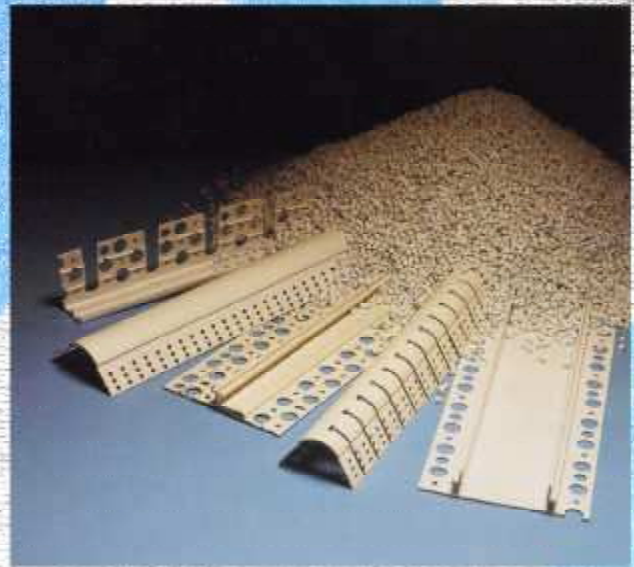

VINYL BEAD ACCESSORIES
Stucco, Drywall & EIFS



SPRING 2002

Stucco Accessories

Spring 2002

Stucco Accessories

TABLE OF CONTENTS

Corner Bead	2 - 3	Banding Bead	16 -17
Equal Length Leg Corner Bead	2	Banding Bead	16
Irregular Length Leg Corner Bead	2	Angled Banding Bead	17
Arched Corner Bead	3	Expansion and Control Joints	18 -21
Bull Nose Corner Bead	3	Type □M□ Expansion Joint	18
Casing Bead	4 - 9	Control Joint with Removable Tape	18
Regular Ground Casing Bead	4	Inside Corner Expansion Joint	18
Deep Ground Casing Bead	4	Outside Corner Expansion Joint	19
Arched Casing Bead	5	2-Piece Expansion Joint with Reveal	19
Wide Flange Casing Bead	6	Expansion Joint Components	20
Casing Bead with Reveal	6	Male Expansion Component	21
One Coat Casing Bead	7	Female Expansion Component	21
Angled Casing Bead	8	Angles	21
Chamfered Casing bead	9	Soffit Accessories	21
Reveals	10 -15	Soffit Screed - (One Piece)	22
Chamfered Reveals	10	Soffit Vent - (Three Piece)	23
Drip Screed with Reveal	11	Soffit Panels - (One Piece)	24
Stucco Reveal with Removable Cap	12	Roof Drip Edge	25
Reveal Connectors	12	Foundation Weep Screed	26
□F□ Channel Reveal	13	Specifications	27
2-Piece Unvented Shadow Reveal	14		
Vented Shadow Reveal	15		



Stucco Corner Bead

Stucco Accessories

Spring 2002

AMICO Vinyl Corner Bead reinforces exterior stucco corners with durable, straight, and rust free vinyl corners. The addition of stiffener ribs and slotted nailing holes makes these products easy and quick to install level and straight. AMICO Regular Leg and Irregular Leg Corner Beads are shipped with a supply of patented connector clips, designed to easily facilitate the installation of continuous lengths of corner beads. (Patent # 5,531,051)

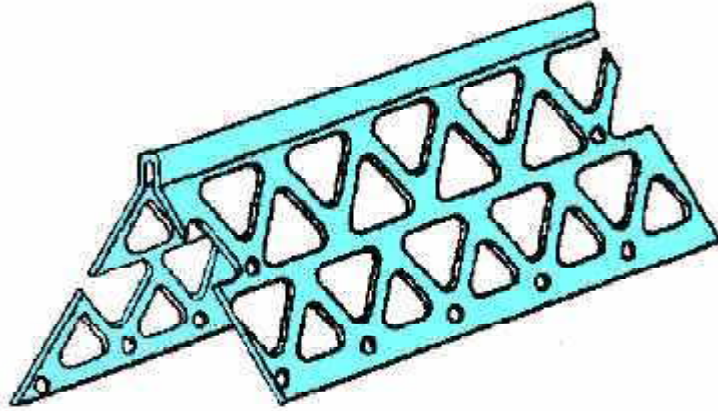

Equal Length Leg Vinyl Corner Bead

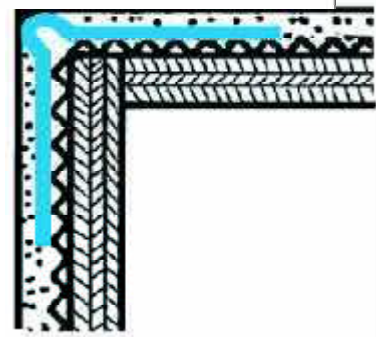

Irregular Length Leg Vinyl Corner Bead

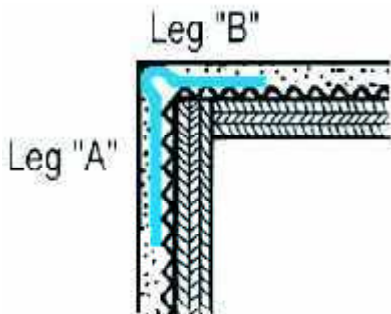

Standard Length: 10 feet

PRODUCT NO.	DIMENSIONS	LEG "A"	LEG "B"	BOX COUNT
CORNER BEAD AMX1	2½" x 2½" Equal Leg	2½"	2½"	50
CORNER BEAD AMX1X	1½" x 1½" Equal Leg	1½"	1½"	50
CORNER BEAD AMX2	2¾" x 2¾" Equal Leg	2¾"	2¾"	40
CORNER BEAD AMX1-WF	4" x 4" Equal Leg	4"	4"	40
CORNER BEAD AMX1-IR	2½" x 1½" Irregular Leg	2½"	1½"	50
CORNER BEAD AMX2-IR	2¾" x 1½" Irregular Leg	2¾"	1½"	40

Stucco Corner Bead

Spring 2002

Stucco Accessories

Vinyl Arched Corner Bead

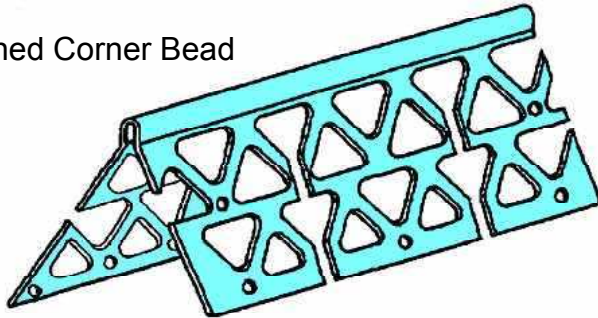

AMICO Arched Corner Bead offers the same quality and performance as our other fine corner bead products with the added benefit that it comes pre-notched to curve to most construction radiuses.

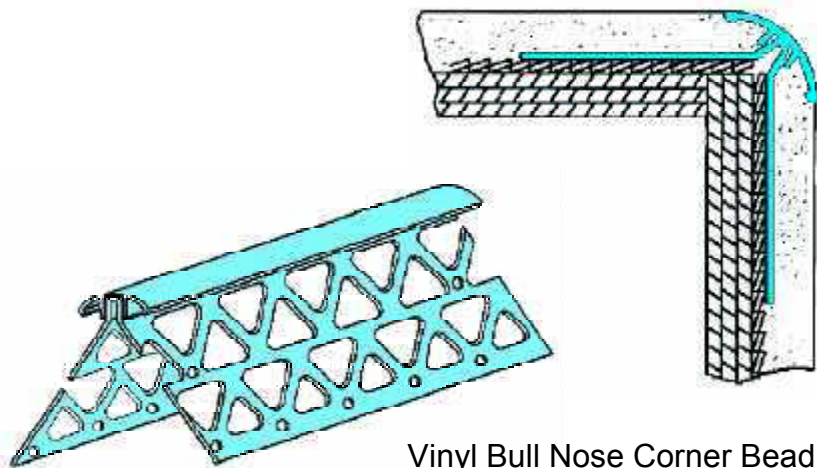

Vinyl Bull Nose Corner Bead

AMICO Bull Nose Corner Bead provides a 3/4" radius with similar damage resistant qualities as that of metal bull nose corner bead. Plus the added advantages that this vinyl bead offers of being rust proof, lightweight, and easy to install.

Standard Length: 10 feet

PRODUCT NO.	DIMENSIONS	GROUND	PCS PER BOX
ARCHED CORNER BEAD AMX1- ARCH	2½" x 2½"	Any	50
ARCHED CORNER BEAD AMX2- ARCH	2¾" x 2¾"	Any	50
BULL NOSE CORNER BEAD AMX1- BN	2½" x 2½"	Any	20
BULL NOSE CORNER BEAD AMX2- BN	2¾" x 2¾"	Any	20



Stucco Casing Bead

AMICO Vinyl Casing Bead is often referred to, by the industry, as a plaster stop because it is used to terminate plaster or stucco. AMICO vinyl casing beads are strong and durable, to give maximum protection to this highly vulnerable stucco area. Casing beads larger than 7/8 inch, have additional reinforcement in the ground flange for extra strength.

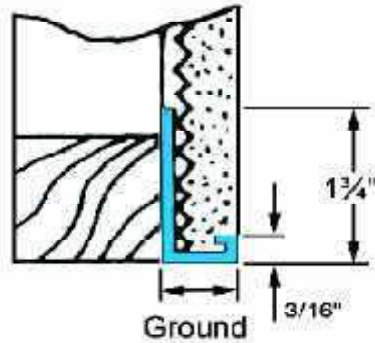

Regular Ground

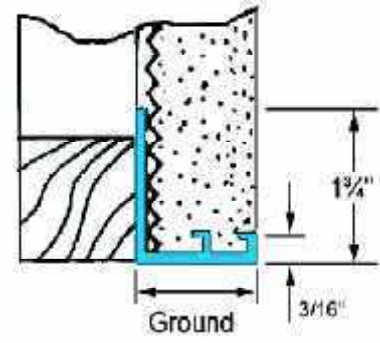

Deep Ground

Standard Length: 10 feet

PRODUCT NO.	DIMENSIONS	GROUND	PCS PER BOX
CASING BEAD REGULAR GROUND AM66-250	1 3/4" Perforated Flange	1/4"	100
CASING BEAD REGULAR GROUND AM66-380	1 3/4" Perforated Flange	3/8"	100
CASING BEAD REGULAR GROUND AM66-500	1 3/4" Perforated Flange	1/2"	100
CASING BEAD REGULAR GROUND AM66-580	1 3/4" Perforated Flange	5/8"	100
CASING BEAD REGULAR GROUND AM66-750	1 3/4" Perforated Flange	3/4"	75
CASING BEAD REGULAR GROUND AM66-780	1 3/4" Perforated Flange	7/8"	75
CASING BEAD DEEP GROUND AM66-1000	1 3/4" Perforated Flange	1"	75
CASING BEAD DEEP GROUND AM66-1250	1 3/4" Perforated Flange	1 1/4"	50
CASING BEAD DEEP GROUND AM66-1500	1 3/4" Perforated Flange	1 1/2"	50
CASING BEAD DEEP GROUND AM66-2000	1 3/4" Perforated Flange	2"	40



Stucco Casing Bead

Spring 2002

Stucco Accessories

AMICO Vinyl Arched Casing Bead offers the same quality and performance as our other fine casing bead products plus it has the capability to curve to most construction radiuses.

(Patent # 5,699,638)

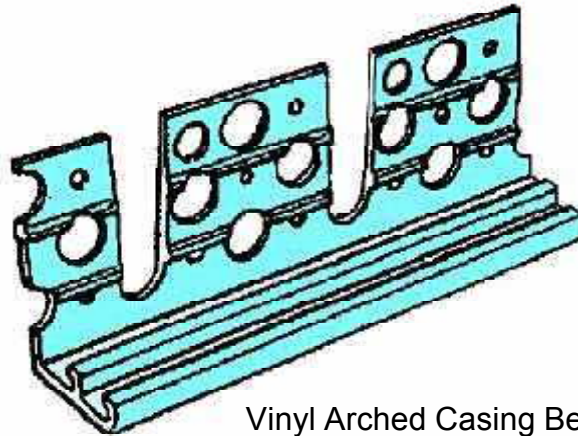

Vinyl Arched Casing Bead

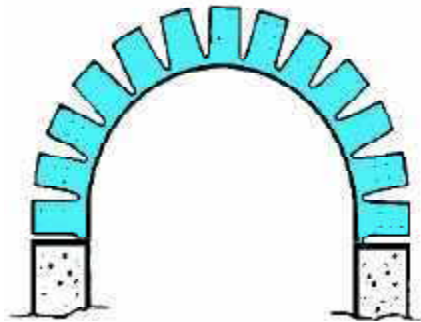

Standard Length: 10 feet

PRODUCT NO.	DIMENSIONS	GROUND	PCS PER BOX
ARCHED CASING BEAD AM66A-250	1 3/4" Perforated Flange	1/4"	25
ARCHED CASING BEAD AM66A-380	1 3/4" Perforated Flange	3/8"	25
ARCHED CASING BEAD AM66A-500	1 3/4" Perforated Flange	1/2"	25
ARCHED CASING BEAD AM66A-580	1 3/4" Perforated Flange	5/8"	25
ARCHED CASING BEAD AM66A-750	1 3/4" Perforated Flange	3/4"	25
ARCHED CASING BEAD AM66A-780	1 3/4" Perforated Flange	7/8"	25
ARCHED CASING BEAD AM66A-1000	1 3/4" Perforated Flange	1"	25
ARCHED CASING BEAD AM66A-1250	1 3/4" Perforated Flange	1 1/4"	25
ARCHED CASING BEAD AM66A-1500	1 3/4" Perforated Flange	1 1/2"	25
ARCHED CASING BEAD AM66A-2000	1 3/4" Perforated Flange	2"	25

Stucco Casing Bead

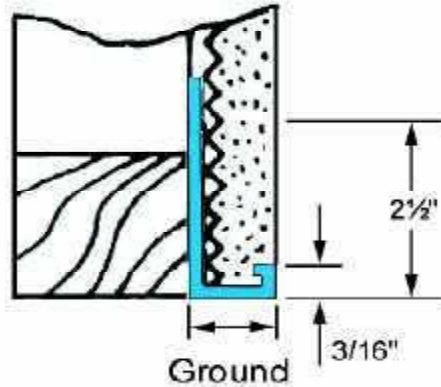
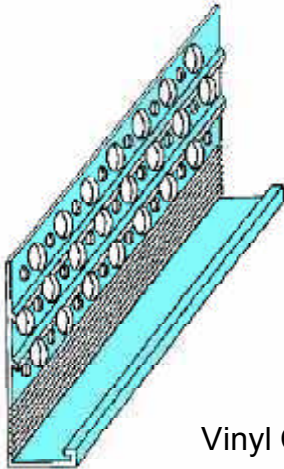

Vinyl Casing Bead with Wide Flange

AMICO Vinyl Wide Flange Casing Bead is used to terminate plaster at the top of the wall and at all through wall penetrations. The extra wide 2½ inch perforated flange is used in those areas that require a wider than normal flange.

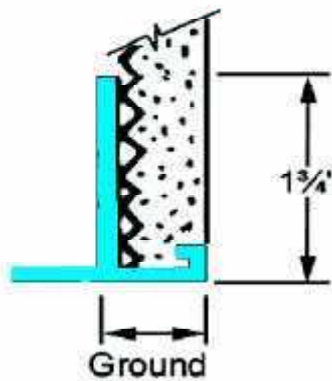
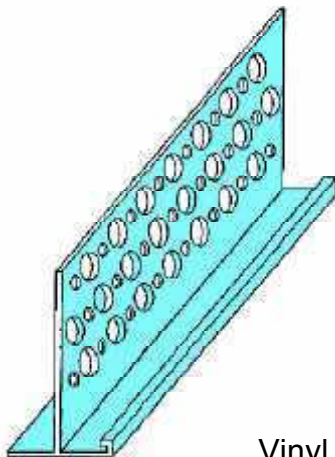

Vinyl Casing Bead with Reveal

AMICO Vinyl Casing with Reveal is used as a plaster termination at windows and (sliding) doors that are inset from the plane of the wall surface, when this inset is not deep enough to use a corner bead. The casing bead with reveal may be the perfect accessory to deal with this transition by eliminating the caulk joint created by a normal casing bead while providing a paintable surface. Caulking and flashing is still required at the juncture of the bead and the window.

Standard Length: 10 feet

PRODUCT NO.	DIMENSIONS	GROUND	PCS PER BOX
WIDE FLANGE CASING BEAD AM66WF-500	2½" Flange	1/2"	100
WIDE FLANGE CASING BEAD AM66WF-580	2½" Flange	5/8"	75
WIDE FLANGE CASING BEAD AM66WF-750	2½" Flange	3/4"	75
CASING BEAD with REVEAL AMRS580-500	1¾" Flange	5/8"	75



Stucco One-Coat Casing Bead

Spring 2002

Stucco Accessories

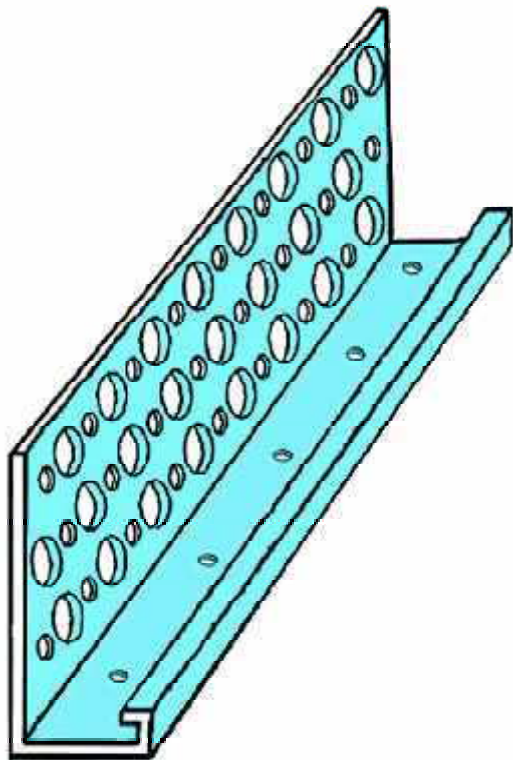

AMICO One-Coat Casing Bead

This vinyl product should be used only with one-coat systems that require perforated casing beads at the bottom of exterior walls. These beads should not be used in three-coat stucco applications or where a foundation weep screed is specified.

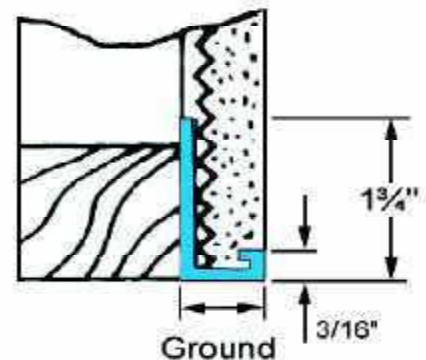

Vinyl Stucco One-Coat Casing Bead

Standard Length: 10 feet

PRODUCT NO.	DIMENSIONS	GROUND	PCS PER BOX
CASING BEAD ONE-COAT AM660C-380	1 3/4" Flange	3/8"	50
CASING BEAD ONE-COAT AM660C-500	1 3/4" Flange	1/2"	50



Stucco Angled Casing Bead

AMICO Vinyl Angled Casing Bead is used to form the top edge of a horizontal wall band. It is used when the applicator chooses not to use angled banding bead.

The down sloping angle permits water to move away from the top edge of the wall and away from the building facade.

AMICO Vinyl Stucco Casing Bead with Deep Ground or Banding Bead (as detailed to the right), can be used on the lower edge.

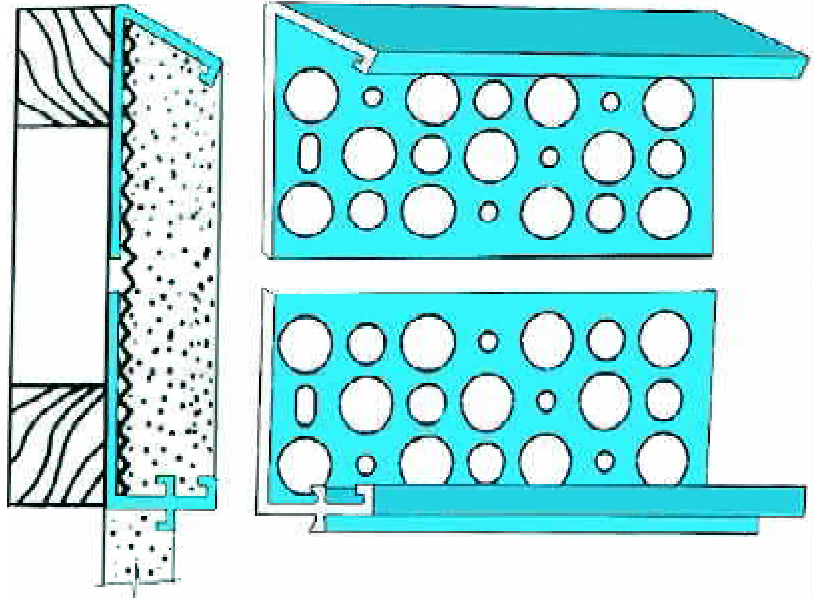

Scale varies with dimension

Standard Length: 10 feet

PRODUCT NO.	DIMENSIONS	GROUND	PCS PER BOX
ANGLED CASING BEAD AM66-Angled-1000	Flange	1"	75
ANGLED CASING BEAD AM66-Angled-1250	Flange	1¼"	50
ANGLED CASING BEAD AM66-Angled-1500	Flange	1½"	40
ANGLED CASING BEAD AM66-Angled-2000	Flange	2"	40

Chamfered / Bull Nose Casing Bead

Spring 2002

Stucco Accessories

AMICO Vinyl Stucco Chamfered and Bull Nose Casing Beads

are used like traditional stucco casing beads to terminate stucco at all openings, such as windows, doors and at the top of walls. The Chamfered and Bull Nose Casing Beads match the profile of the Chamfered and Bull Nose Reveals. These **patent pending** products were designed to satisfy the demand for innovative and creative stucco accessories. When used with stucco reveals of the same design and our Chamfered and Bull Nose Corner Beads, the entire look of the stucco assembly is enhanced. All joints should be imbedded in caulk and caulked after installation if necessary.

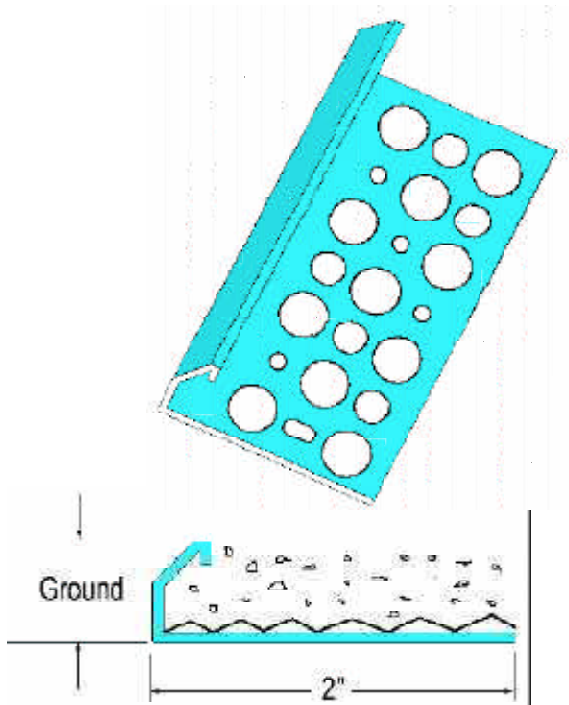

Chamfered Casing Bead

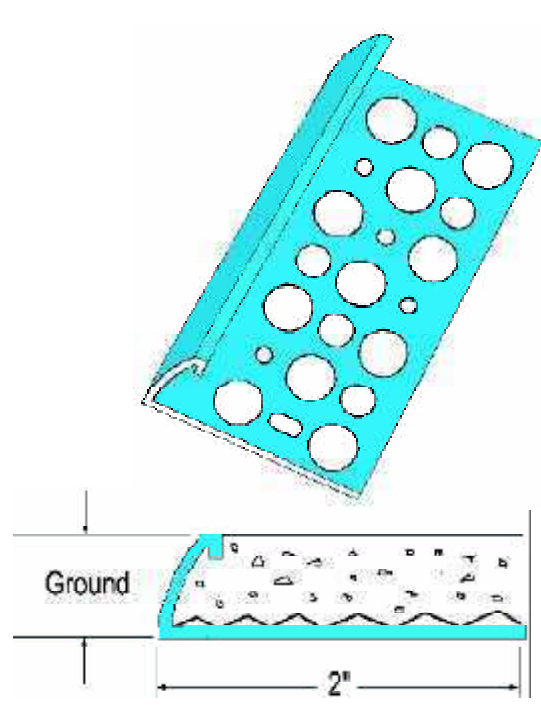

Bull Nose Casing Bead

PRODUCT NO.	DIMENSIONS	GROUND	PCS PER BOX
CHAMFERED STUCCO CASING BEAD AM66CH-580	1 3/4" FLANGE	5/8"	60
CHAMFERED STUCCO CASING BEAD AM66CH-750	1 3/4" FLANGE	3/4"	50
CHAMFERED STUCCO CASING BEAD AM66CH-780	1 3/4" FLANGE	7/8"	50
CHAMFERED STUCCO CASING BEAD AM66CH-1000	1 3/4" FLANGE	1"	50
CHAMFERED STUCCO CASING BEAD AM66CH-1250	1 3/4" FLANGE	1 1/4"	50

PRODUCT NO.	DIMENSIONS	GROUND	PCS PER BOX
BULL NOSE STUCCO CASING BEAD AM66BN-580	1 3/4" FLANGE	5/8"	60
BULL NOSE STUCCO CASING BEAD AM66BN-750	1 3/4" FLANGE	3/4"	50
BULL NOSE STUCCO CASING BEAD AM66BN-780	1 3/4" FLANGE	7/8"	50
BULL NOSE STUCCO CASING BEAD AM66BN-1000	1 3/4" FLANGE	1"	50
BULL NOSE STUCCO CASING BEAD AM66BN-1250	1 3/4" FLANGE	1 1/4"	50



Chamfered / Bull Nose Reveals

AMICO Vinyl Stucco Chamfered and Bull Nose Reveals

are used to provide an architecturally pleasing break in the surface area of a stucco wall. Chamfered and Bull Nose reveals are an improvement over standard stucco reveals in that they offer a new more appealing look to the design and an improved mechanism for stucco embedment. This will improve the bond between the stucco and the joint to help reduce separation at these locations. To function properly the stucco should be forced under the lip of the bead.

These **patent pending** products were designed to satisfy the demand for innovative and creative stucco accessories. When used with casing beads of the same design and our Bull Nose Corner Beads, the entire look of the stucco assembly is enhanced. Reveals are not to be considered or used as expansion joints. All joints should be imbedded in caulk and caulked after installation if necessary.

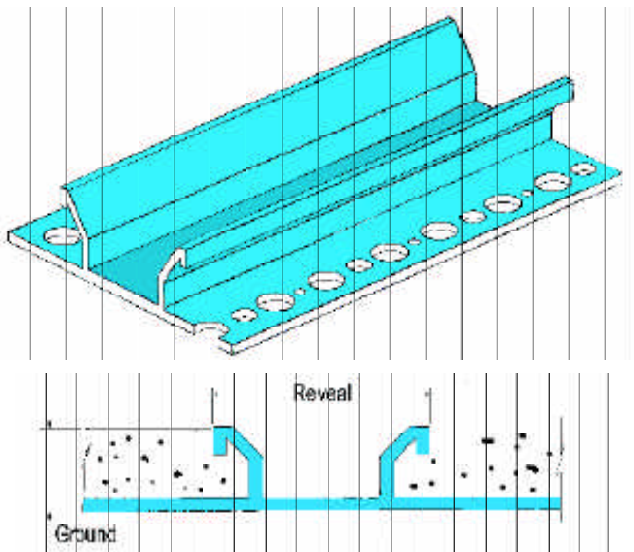

Vinyl Stucco Chamfered Reveal

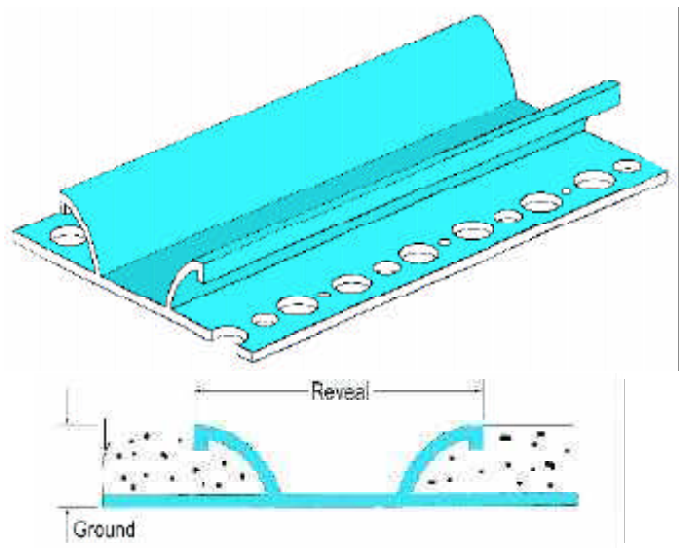

Vinyl Stucco Bull Nose Reveal

PRODUCT NO.	GROUND	REVEAL	PCS PER BOX
CHAMFERED STUCCO REVEAL AMCSR580-1000	5/8"	1"	25
CHAMFERED STUCCO REVEAL AMCSR580-1500	5/8"	1½"	20
CHAMFERED STUCCO REVEAL AMCSR750-1000	3/4"	1"	25
CHAMFERED STUCCO REVEAL AMCSR750-1500	3/4"	1½"	20
CHAMFERED STUCCO REVEAL AMCSR780-1000	7/8"	1"	20
CHAMFERED STUCCO REVEAL AMCSR780-1500	7/8"	1½"	20

PRODUCT NO.	GROUND	REVEAL	PCS PER BOX
BULL NOSE STUCCO REVEAL AMBNR580-1000	5/8"	1"	25
BULL NOSE STUCCO REVEAL AMBNR580-1500	5/8"	1½"	20
BULL NOSE STUCCO REVEAL AMBNR750-1000	3/4"	1"	25
BULL NOSE STUCCO REVEAL AMBNR750-1500	3/4"	1½"	20
BULL NOSE STUCCO REVEAL AMBNR780-1000	7/8"	1"	20
BULL NOSE STUCCO REVEAL AMBNR780-1500	7/8"	1½"	20



Drip Screed with Reveal

Spring 2002

Stucco Accessories

AMICO Vinyl Drip Screed with 1/4" Reveal and Control Joint

This two piece design allows for a drip edge in stucco and the control joint helps to relieve stress in soffits and creates 1/4" reveal.

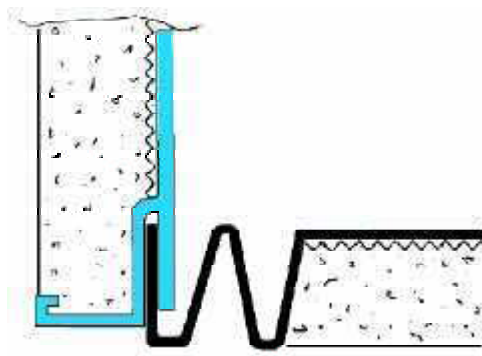
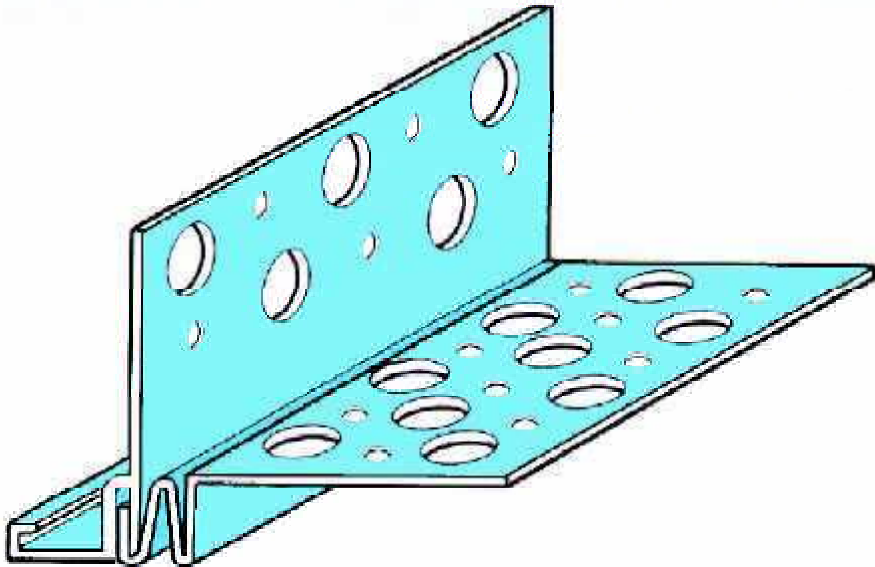

Standard Length: 10 feet

PRODUCT NO.	GROUND	REVEAL	PCS PER BOX
DRIP SCREED WITH REVEAL AND CONTROL JOINT AMDS750-750	3/4"	3/4"	15

Stucco Reveal

AMICO Vinyl Stucco Reveal

(Available with removable masking caps for most sizes)

are used to provide architectural relief in stucco walls. This product creates breaks in stucco to create architecturally pleasing walls. This does not perform the function of an expansion joint because it does not allow for movement in the same way as an expansion joint. Reveals are shipped with a supply of reveal clips as an aid to align adjoining sections.

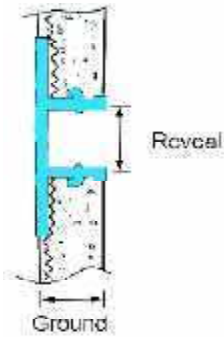

AMICO Vinyl Stucco Reveal Connectors or Junctions are available for all of the reveals listed above. These junctions are welded via a patented process for extra strength and to provide a thin and smooth transition. All joints should be caulked to prevent leakage at the juncture of the reveal and the junction.

(Patent #5,761,866)

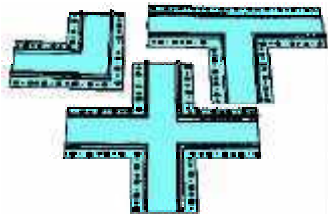

Stucco Reveal Connectors

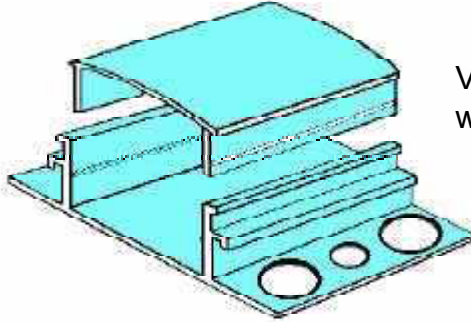

Vinyl Stucco Reveal with Removeable Cap

Standard Length: 10 feet

PRODUCT NO.	GROUND	REVEAL	PCS PER BOX
AMSR500-500	1/2"	1/2"	35
AMSR750-500	3/4"	1/2"	35
AMSR500--750	1/2"	3/4"	35
AMSR750-750	3/4"	3/4"	25
AMSR500-1000	1/2"	1"	25
AMSR580-1000	5/8"	1"	25
AMSR750-1000	3/4"	1"	25
AMSR500-1500	1/2"	1 1/2"	20
AMSR580-1500	5/8"	1 1/2"	20
AMSR750-1500	3/4"	1 1/2"	20
AMSR500-2000	1/2"	2"	20
AMSR580-2000	5/8"	2"	14
AMSR750-2000	3/4"	2"	14
AMSR750-2500 Cap Not Available	3/4"	2 1/2"	15
AMSR750-3000 Cap Not Available	3/4"	3"	15
REVEAL CONNECTORS (JUNCTIONS)	Order per Job Requirement		

'F' Channel Reveal

Spring 2002

Stucco Accessories

□F□ Channel Reveal
with Removeable Cap

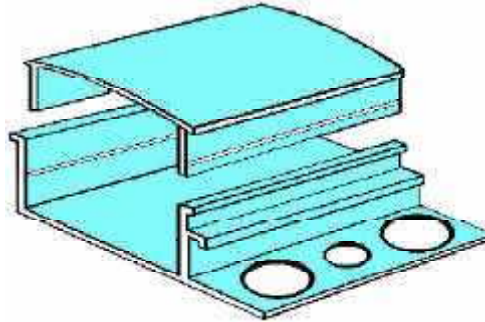

Standard Length: 10 feet

PRODUCT NO.	GROUND	REVEAL	PCS PER BOX
"F" CHANNEL REVEAL AMFR500-750	1/2"	3/4"	25
"F" CHANNEL REVEAL AMFR750-750	3/4"	3/4"	25
"F" CHANNEL REVEAL AMFR500-1000	1/2"	1"	25
"F" CHANNEL REVEAL AMFR580-1000	5/8"	1"	25
"F" CHANNEL REVEAL AMFR750-1000	3/4"	1"	25
"F" CHANNEL REVEAL AMFR500-1500	1/2"	1 1/2"	25
"F" CHANNEL REVEAL AMFR500-2000	1/2"	2"	25
"F" CHANNEL REVEAL AMFR580-1500	5/8"	1 1/2"	25
"F" CHANNEL REVEAL AMFR580-2000	5/8"	2"	25
"F" CHANNEL REVEAL AMFR750-1500	3/4"	1 1/2"	25
"F" CHANNEL REVEAL AMFR750-2000	3/4"	2"	25

AMICO Vinyl "F" Channel Reveal forms 3/4", 1" and 1 1/2" reveals in wall and ceiling designs as well as addressing the juncture of dissimilar materials. This bead does not perform the function of an expansion joint because it does not allow for movement.

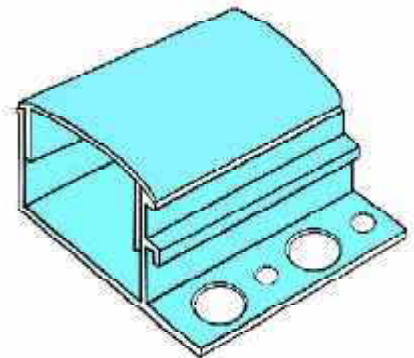
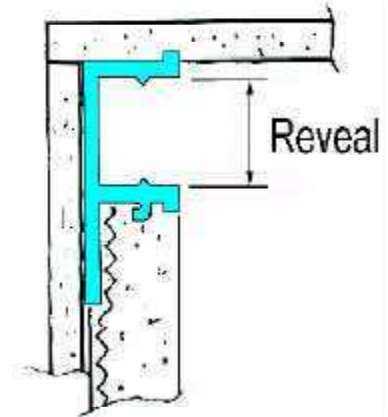

Vinyl □F□ Channel Reveal
with Removeable Cap

Note:
Available in all Channel
Reveal Grounds as detailed
on Page 12.

2-Piece Shadow Reveal

AMICO Expansion Shadow Reveal (2-Piece)

form reveals from 1/2" to 1 1/4" while providing for expansion and contraction at the juncture of the wall and ceiling. This accessory is designed to relieve stress caused by normal stucco shrinkage and thermal movement.

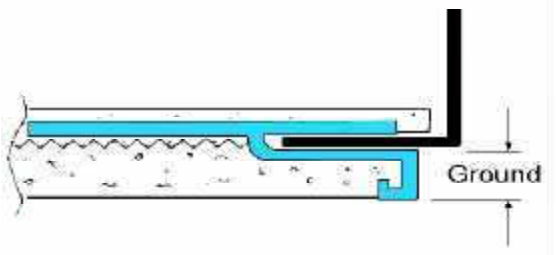
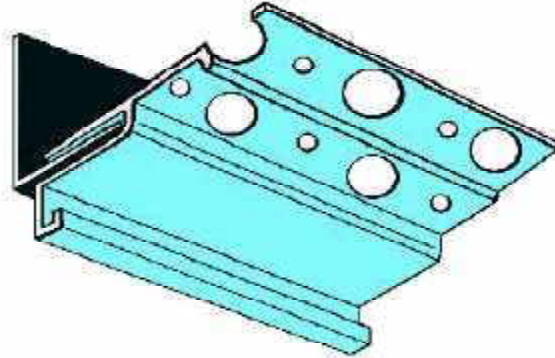

Standard Length: 10 feet
Packed 20 Pieces per Box

PRODUCT NO.	DIMENSIONS	GROUND
2-PC. SHADOW REVEAL AMESR380-500	Adjustable 1/2" to 3/4" 3/4" Vertical Leg	3/8"
2-PC. SHADOW REVEAL AMESR500-500	Adjustable 1/2" to 3/4" 3/4" Vertical Leg	1/2"
2-PC. SHADOW REVEAL AMESR580-500	Adjustable 1/2" to 3/4" 3/4" Vertical Leg	5/8"
2-PC. SHADOW REVEAL AMESR750-500	Adjustable 1/2" to 3/4" 3/4" Vertical Leg	3/4"
2-PC. SHADOW REVEAL AMESR780-500	Adjustable 1/2" to 3/4" 3/4" Vertical Leg	7/8"
2-PC. SHADOW REVEAL AMESR380-750	Adjustable 3/4" to 1" 1" Vertical Leg	3/8"
2-PC. SHADOW REVEAL AMESR500-750	Adjustable 3/4" to 1" 1" Vertical Leg	1/2"
2-PC. SHADOW REVEAL AMESR580-750	Adjustable 3/4" to 1" 1" Vertical Leg	5/8"
2-PC. SHADOW REVEAL AMESR750-750	Adjustable 3/4" to 1" 1" Vertical Leg	3/4"
2-PC. SHADOW REVEAL AMESR780-750	Adjustable 3/4" to 1" 1" Vertical Leg	7/8"
2-PC. SHADOW REVEAL AMESR380-1000	Adjustable 1" to 1 1/4" 1 1/2" Vertical Leg	3/8"
2-PC. SHADOW REVEAL AMESR500-1000	Adjustable 1" to 1 1/4" 1 1/2" Vertical Leg	1/2"
2-PC. SHADOW REVEAL AMESR580-1000	Adjustable 1" to 1 1/4" 1 1/2" Vertical Leg	5/8"
2-PC. SHADOW REVEAL AMESR750-1000	Adjustable 1" to 1 1/4" 1 1/2" Vertical Leg	3/4"
2-PC. SHADOW REVEAL AMESR780-1000	Adjustable 1" to 1 1/4" 1 1/2" Vertical Leg	7/8"

Vented Shadow Reveal

Spring 2002

Stucco Accessories

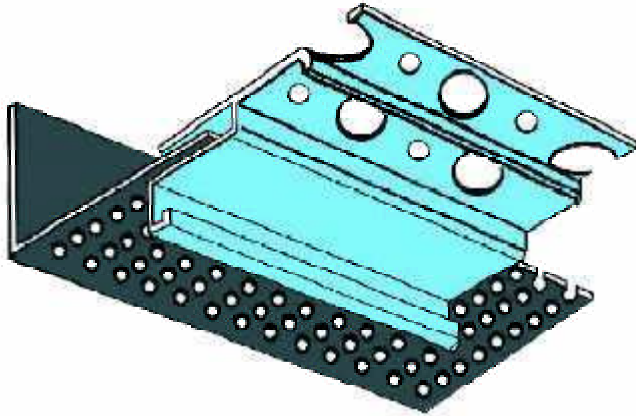

AMICO Vented Shadow Reveals
(2-Piece)

with 2" perforated flange, our Vented Reveals are designed for stucco applications that require an architectural reveal and venting at the juncture of soffits with adjacent walls. This product also allows for expansion and contraction in this area.

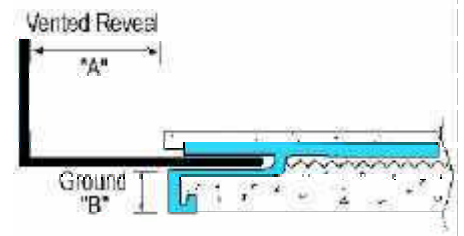

PRODUCT NO.	VENTED REVEAL "A"	GROUND "B"
VENTED SHADOW REVEAL AMVSR200-380	2"	3/8"
VENTED SHADOW REVEAL AMVSR200-500	2"	1/2"
VENTED SHADOW REVEAL AMVSR200-750	2"	3/4"
VENTED SHADOW REVEAL AMVSR300-380	3"	3/8"
VENTED SHADOW REVEAL AMVSR300-500	3"	1/2"
VENTED SHADOW REVEAL AMVSR300-750	3"	3/4"
VENTED SHADOW REVEAL AMVSR400-380	4"	3/8"
VENTED SHADOW REVEAL AMVSR400-500	4"	1/2"
VENTED SHADOW REVEAL AMVSR400-750	4"	3/4"

Standard Length: 10 feet
Packed 15 Pieces per Box



Stucco Banding Bead

Stucco Accessories

Spring 2002

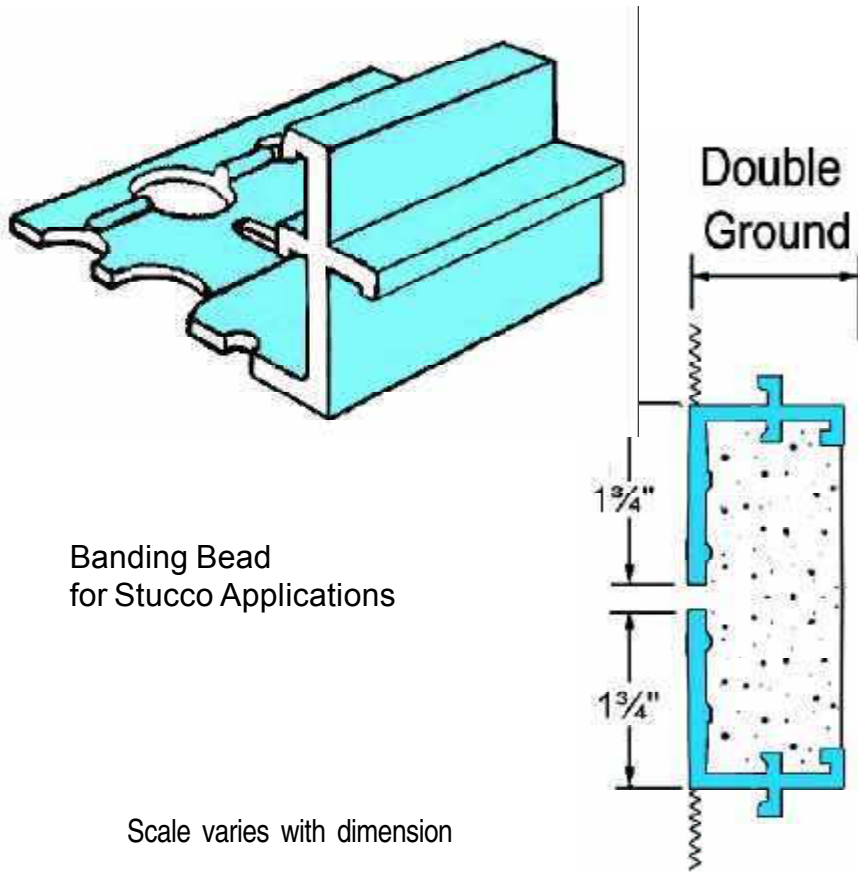

Banding Bead
for Stucco Applications

Scale varies with dimension

AMICO

Vinyl Angled Banding Bead

is used to form the TOP EDGES of horizontal bands. This bead forms sharp and clean edges the same as our standard banding bead. The ANGLED TOP EDGE or surface allows water to drain away from the wall surface. A double ground or screed lip has been provided to facilitate the screeding of the adjoining stucco. Different thicknesses of stucco are applied creating the band.

Standard Length: 10 feet

PRODUCT NO.	DIMENSIONS	GROUND	PCS PER BOX	BAND THICKNESS
BANDING BEAD AMBB-750-500	1 3/4"	3/4" x 1/2"	30	3/4"
BANDING BEAD AMBB-1000-500	1 3/4"	1" x 1/2"	30	1"
BANDING BEAD AMBB-1500-500	1 3/4"	1 1/2" x 1/2"	30	1 1/2"
BANDING BEAD AMBB-1500-750	1 3/4"	1 1/2" x 3/4"	30	1 1/2"

Stucco Angled Banding Bead

Spring 2002

Stucco Accessories

AMICO Vinyl Banding Bead is used to form the sharp clean edges of horizontal bands. A double ground or screed lip has been provided to facilitate the screeding of the adjoining stucco.

Different thicknesses of stucco are applied creating the band. Our double ground allows for a true, straight and clean band for stucco applications.

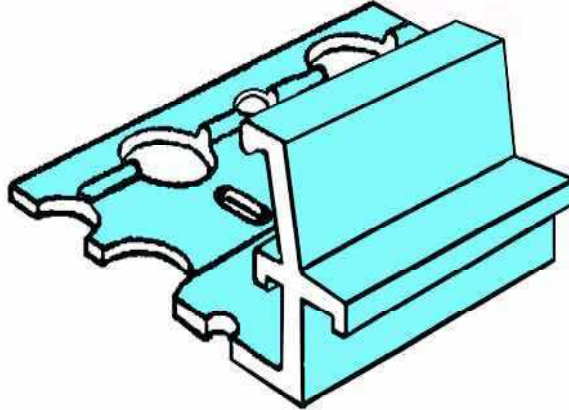

Angled Banding Bead for stucco applications

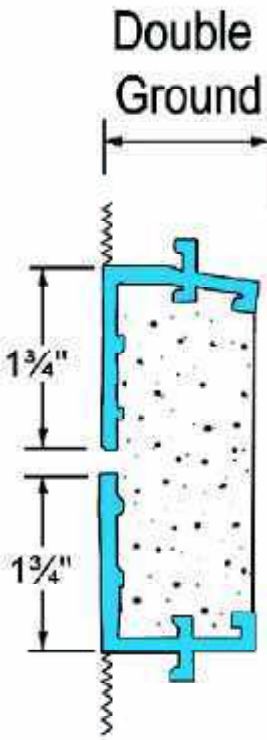

Standard Length: 10 feet

PRODUCT NO.	DIMENSIONS	GROUND	PCS PER BOX	BAND THICKNESS
ANGLED BANDING BEAD AMBB-750-500 Angled	1 3/4"	3/4" x 1/2"	30	3/4"
ANGLED BANDING BEAD AMBB-1000-500 Angled	1 3/4"	1" x 1/2"	30	1"
ANGLED BANDING BEAD AMBB-1500-500 Angled	1 3/4"	1 1/2" x 1/2"	30	1 1/2"
ANGLED BANDING BEAD AMBB-1500-750 Angled	1 3/4"	1 1/2" x 3/4"	30	1 1/2"

Scale varies with dimension



Expansion/ Control Joint

AMICO Vinyl "M" Type Expansion Joint with Removable Tape is designed to relieve stress in the stucco membrane caused by typical stucco shrinkage and thermal movement.

Note: Removable tape has been provided to clean the joint after stucco application.

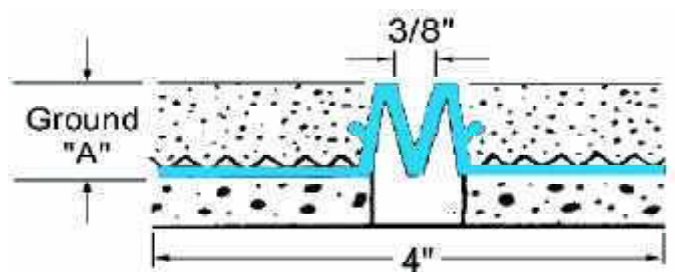

scale varies with dimension
"M" Type Expansion Joint

AMICO Vinyl Control Joint with Removable Tape is an improved version of the "M" type expansion joint. This Control Joint provides returns to better lock into the stucco.

Note: Removable tape has been provided to clean the joint after stucco application.

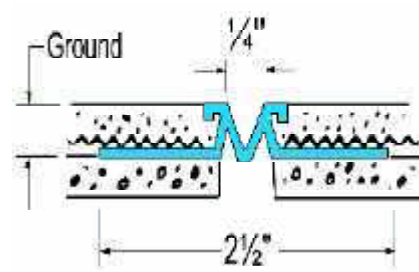
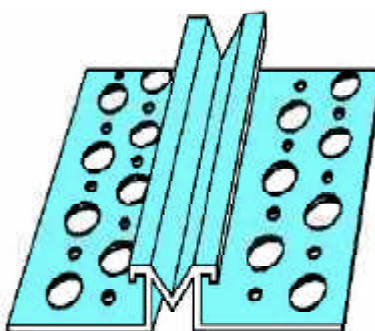

Vinyl Control Joint

Standard Length: 10 feet

PRODUCT NO.	DIMENSIONS	GROUND "A"	PCS PER BOX
EXPANSION JOINT AMCJM-380	4" Overall Width Perforated Flange	3/8"	35
EXPANSION JOINT AMCJM500	4" Overall Width Perforated Flange	1/2"	35
EXPANSION JOINT AMCJM-580	4" Overall Width Perforated Flange	5/8"	30
EXPANSION JOINT AMCJM-750	4" Overall Width Perforated Flange	3/4"	25
EXPANSION JOINT AMCJM-780	4" Overall Width Perforated Flange	7/8"	20
CONTROL JOINT AMCJX-250	2 1/2" Overall Width Perforated Flange	1/4"	50

Corner Expansion Joint

Spring 2002

Stucco Accessories

AMICO Corner Expansion Joint Outside (3-Piece)

is designed to relieve stress in stucco at outside corners where excess movement or shrinkage might result in cracked stucco.

AMICO Corner Expansion Joint Inside (3-Piece)

is designed to relieve stress in stucco at inside corners where excess movement or shrinkage might result in cracked stucco.

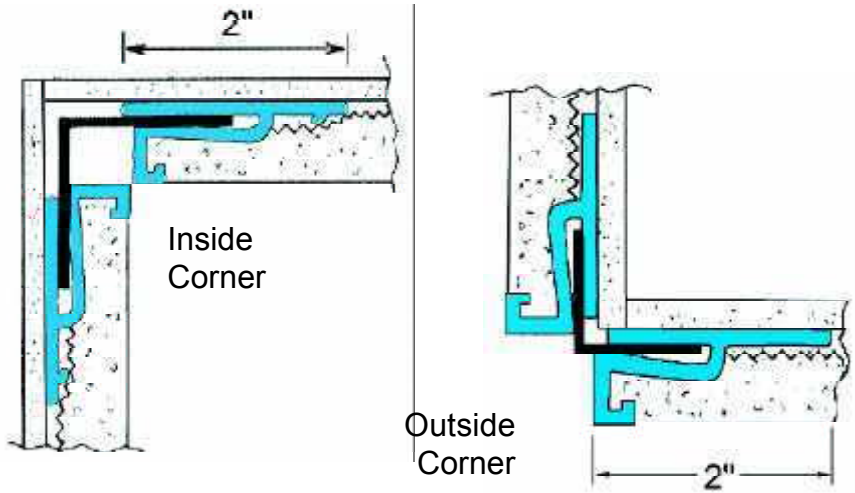

PRODUCT NO.	DIMENSIONS	GROUND	PCS PER BOX
OUTSIDE CORNER EXPANSION JOINT AMXJO380	Perforated Flange	3/8"	15
OUTSIDE CORNER EXPANSION JOINT AMXJO500	Perforated Flange	1/2"	15
OUTSIDE CORNER EXPANSION JOINT AMXJO580	Perforated Flange	5/8"	15
OUTSIDE CORNER EXPANSION JOINT AMXJO750	Perforated Flange	3/4"	15
OUTSIDE CORNER EXPANSION JOINT AMXJO780	Perforated Flange	7/8"	12
INSIDE CORNER EXPANSION JOINT AMXJI380	Perforated Flange	3/8"	15
INSIDE CORNER EXPANSION JOINT AMXJI500	Perforated Flange	1/2"	15
INSIDE CORNER EXPANSION JOINT AMXJI580	Perforated Flange	5/8"	15
INSIDE CORNER EXPANSION JOINT AMXJI750	Perforated Flange	3/4"	15
INSIDE CORNER EXPANSION JOINT AMXJI780	Perforated Flange	7/8"	12

Standard Length: 10 feet



2-Piece Expansion Joint

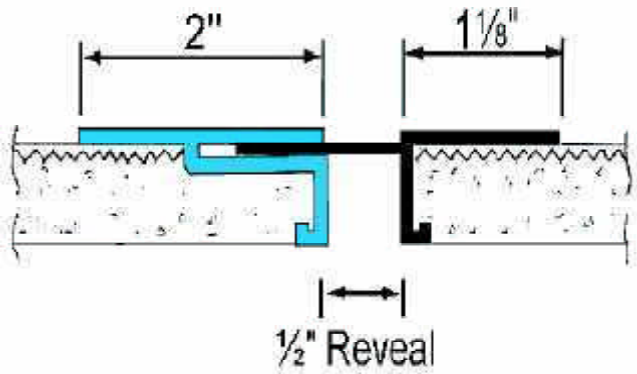

AMICO Vinyl 2-Piece Expansion Joint with 1/2" Reveal is designed to relieve stresses in stucco wall and ceiling areas where a greater than normal degree of movement might occur. This joint allows for movement in two different planes and is recommended where two different framing materials meet and at through wall construction joints.

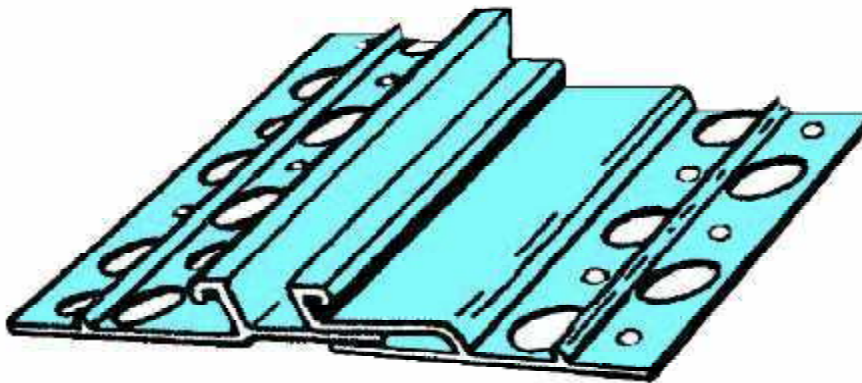

2-Piece Expansion Joint with 1/2" Reveal

Standard Length: 10 feet

PRODUCT NO.	DIMENSIONS	REVEAL	GROUND	PCS PER BOX
2-PIECE EXPANSION JOINT AMEJ380-500	Adjustable 1/4" to 5/8" Perforated Flange	1/2"	3/8"	25
2-PIECE EXPANSION JOINT AMEJ500-500	Adjustable 1/4" to 5/8" Perforated Flange	1/2"	1/2"	25
2-PIECE EXPANSION JOINT AMEJ580-500	Adjustable 1/4" to 5/8" Perforated Flange	1/2"	5/8"	25
2-PIECE EXPANSION JOINT AMEJ750-500	Adjustable 1/4" to 5/8" Perforated Flange	1/2"	3/4"	25
2-PIECE EXPANSION JOINT AMEJ780-500	Adjustable 1/4" to 5/8" Perforated Flange	1/2"	7/8"	20

Expansion Joint Components

Spring 2002

Stucco Accessories

Male Expansion Component

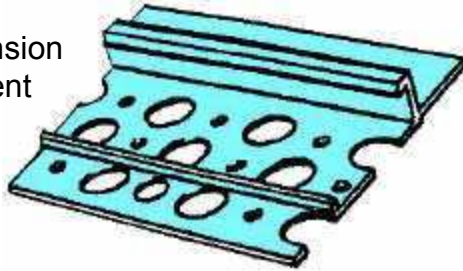

Female Expansion Component

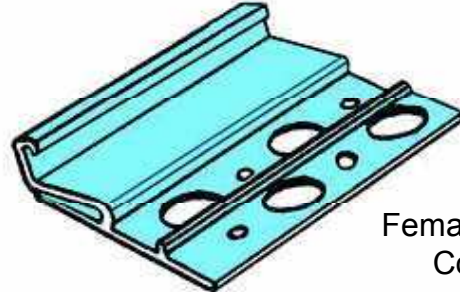

Standard Length: 10 feet

PRODUCT NO.	TYPE	GROUND	PIECES
FEMALE 2-PIECE EXPANSION JOINT AMFEJ380	FEMALE	3/8"	50
FEMALE 2-PIECE EXPANSION JOINT AMFEJ500	FEMALE	1/2"	50
FEMALE 2-PIECE EXPANSION JOINT AMFEJ580	FEMALE	5/8"	50
FEMALE 2-PIECE EXPANSION JOINT AMFEJ750	FEMALE	3/4"	50
FEMALE 2-PIECE EXPANSION JOINT AMFEJ780	FEMALE	7/8"	50
MALE 2-PIECE EXPANSION JOINT AMMEJ380	MALE	3/8"	50
MALE 2-PIECE EXPANSION JOINT AMMEJ500	MALE	1/2"	50
MALE 2-PIECE EXPANSION JOINT AMMEJ580	MALE	5/8"	50
MALE 2-PIECE EXPANSION JOINT AMMEJ750	MALE	3/4"	50
MALE 2-PIECE EXPANSION JOINT AMMEJ780	MALE	7/8"	50

AMICO

Male Expansion Component

Is the companion part of the two piece expansion joint and other multi-part expansion joints. Designed to relieve stucco stress in wall and ceiling areas where excessive horizontal and vertical movements might occur.

AMICO

Female Expansion Component

is half of the two piece expansion joint and other multi-part expansion joints. It is used to fabricate reveals and soffit joints, which incorporate expansion.

AMICO Vinyl Angles

used with inside and outside corner expansion joints or sold separately.

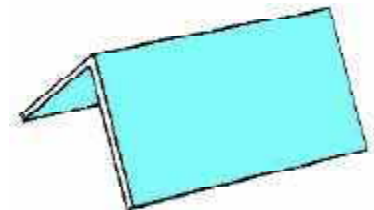

PRODUCT NO.	DIMENSIONS	LEGS	PIECES
VINYL ANGLES AM750-750	3/4" x 3/4"	3/4"	50
VINYL ANGLES AM1000-1000	1" x 1"	1"	50
VINYL ANGLES AM1500-1500	1 1/2" x 1 1/2"	1 1/2"	50



Vinyl Soffit Screed

AMICO Vinyl Soffit Screed

2", 3", and 4" vents are continuous one-piece vents for stucco applications in soffit areas, used to allow for attic ventilation. Beads located at the edges of this product act as casing beads, providing a screed surface for stucco application. Clips are provided to aid in proper alignment of multiple sections.

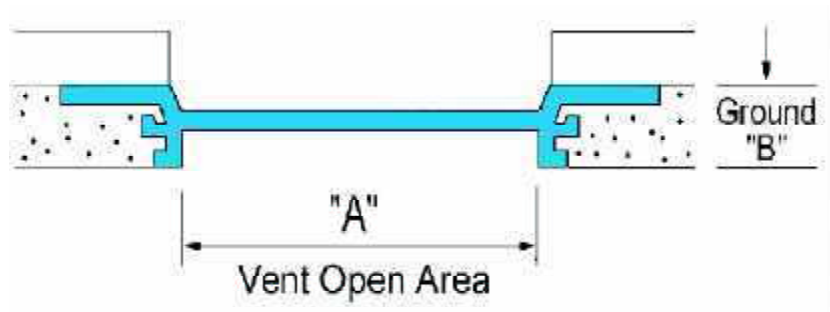

Vinyl Soffit Screed

Standard Length: 10 feet

PRODUCT NO.	DIMENSIONS	VENT WIDTH "A"	VENT OPEN AREA	GROUND "B"	PCS PER BOX
2" SOFFIT SCREED AMSVS200-500	3¾" Overall Width	2"	9.2 Sq Inches Per Lineal Ft	1/2"	15
2" SOFFIT SCREED AMSVS200-750	3¾" Overall Width	2"	9.2 Sq Inches Per Lineal Ft	¾"	15
2" SOFFIT SCREED AMSVS200-780	3¾" Overall Width	2"	9.2 Sq Inches Per Lineal Ft	7/8"	13
3" SOFFIT SCREED AMSVS300-500	4¾" Overall Width	3"	14.0 Sq Inches Per Lineal Ft	1/2"	15
3" SOFFIT SCREED AMSVS300-750	4¾" Overall Width	3"	14.0 Sq Inches Per Lineal Ft	¾"	15
3" SOFFIT SCREED AMSVS300-780	4¾" Overall Width	3"	14 Sq Inches Per Lineal Ft	7/8"	13
4" SOFFIT SCREED AMSVS400-500	5¾" Overall Width	4"	18.6 Sq Inches Per Lineal Ft	1/2"	15
4" SOFFIT SCREED AMSVS400-750	5¾" Overall Width	4"	18.6 Sq Inches Per Lineal Ft	¾"	15
4" SOFFIT SCREED AMSVS400-780	5¾" Overall Width	4"	18.6 Sq Inches Per Lineal Ft	7/8"	13

Vinyl Soffit Vent

Spring 2002

Stucco Accessories

AMICO Vinyl Soffit Vents (3 Piece)

2", 3", and 4" are continuous three-piece vents for stucco applications in soffit areas, used to allow for attic ventilation. The three-piece vent also allows for expansion and contraction in these areas. The two outside casing type components provide grounds that match the thickness of the stucco and can be used as screeds. Clips are provided to aid in proper alignment of multiple sections.

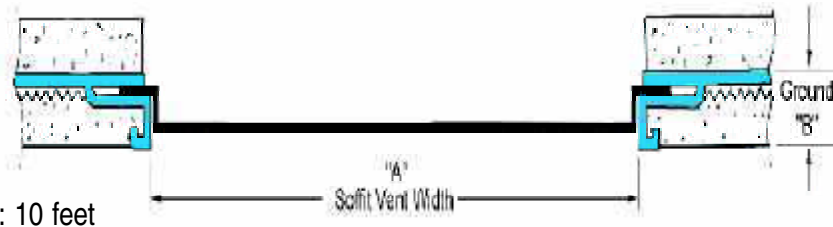

Standard Length: 10 feet

PRODUCT NO.	VENT WIDTH "A"	VENT OPEN AREA	GROUND "B"	PCS PER BOX
1" SOFFIT VENT AMSV750-100	1" Wide Removeable Vent 6-1/8" Overall Width	4.6 Sq Inches Per Lineal Ft	3/4"	13
2" SOFFIT VENT AMSV380-200	2" Wide Removeable Vent 6-1/8" Overall Width	9.2 Sq Inches Per Lineal Ft	3/8"	15
2" SOFFIT VENT AMSV500-200	2" Wide Removeable Vent 6-1/8" Overall Width	9.2 Sq Inches Per Lineal Ft	1/2"	13
2" SOFFIT VENT AMSV750-200	2" Wide Removeable Vent 6-1/8" Overall Width	9.2 Sq Inches Per Lineal Ft	3/4"	11
2" SOFFIT VENT AMSV780-200	2" Wide Removeable Vent 6-1/8" Overall Width	9.2 Sq Inches Per Lineal Ft	7/8"	10
3" SOFFIT VENT AMSV380-300	3" Wide Removeable Vent 7-1/8" Overall Width	14.0 Sq Inches Per Lineal Ft	3/8"	15
3" SOFFIT VENT AMSV500-300	3" Wide Removeable Vent 7-1/8" Overall Width	14.0 Sq Inches Per Lineal Ft	1/2"	13
3" SOFFIT VENT AMSV750-300	3" Wide Removeable Vent 7-1/8" Overall Width	14.0 Sq Inches Per Lineal Ft	3/4"	11
3" SOFFIT VENT AMSV780-300	3" Wide Removeable Vent 7-1/8" Overall Width	14.0 Sq Inches Per Lineal Ft	7/8"	10
4" SOFFIT VENT AMSV380-400	4" Wide Removeable Vent 8-1/8" Overall Width	18.6 Sq Inches Per Lineal Ft	3/8"	15
4" SOFFIT VENT AMSV500-400	4" Wide Removeable Vent 8-1/8" Overall Width	18.6 Sq Inches Per Lineal Ft	1/2"	13
4" SOFFIT VENT AMSV750-400	4" Wide Removeable Vent 8-1/8" Overall Width	18.6 Sq Inches Per Lineal Ft	3/4"	11
4" SOFFIT VENT AMSV780-400	4" Wide Removeable Vent 8-1/8" Overall Width	18.6 Sq Inches Per Lineal Ft	7/8"	10

Note: Also available in 5/8"



Vinyl Soffit Panels

Stucco Accessories

Spring 2002

Soffit Vent Panel with Shadow Reveal

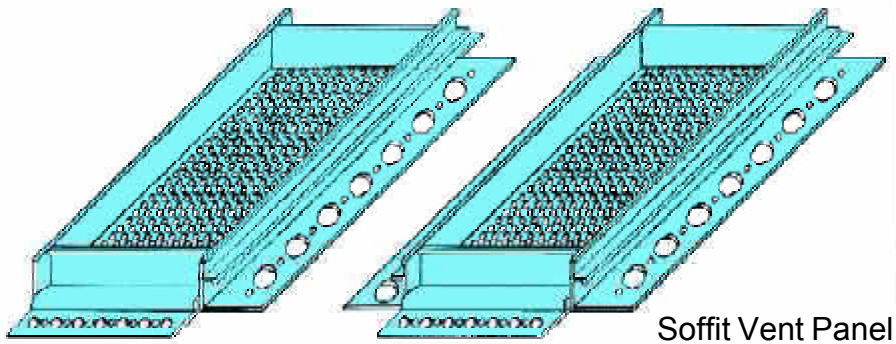

Soffit Vent Panel

AMICO Vinyl soffit Vent Panels provide ventilation in the soffit to prevent condensation while providing casing beads for surrounding stucco applications.

All Panels are 24" in Length
25 Pieces Per Box
Standard Length: 10 feet

SOFFIT VENT PANEL WITH REVEAL PRODUCT NO.	GROUND
AMSVR200-380	3/8"
AMSVR200-500	1/2"
AMSVR200-580	5/8"
AMSVR200-750	3/4"
AMSVR200-780	7/8"
AMSVR300-380	3/8"
AMSVR300-500	1/2"
AMSVR300-580	5/8"
AMSVR300-750	3/4"
AMSVR300-780	7/8"
AMSVR400-380	3/8"
AMSVR400-500	1/2"
AMSVR400-580	5/8"
AMSVR400-750	3/4"
AMSVR400-780	7/8"

SOFFIT VENT PANEL WITHOUT REVEAL PRODUCT NO.	GROUND
AMSVS200-380	3/8"
AMSVS200-500	1/2"
AMSVS200-580	5/8"
AMSVS200-750	3/4"
AMSVS200-780	7/8"
AMSVS300-380	3/8"
AMSVS300-500	1/2"
AMSVS300-580	5/8"
AMSVS300-750	3/4"
AMSVS300-780	7/8"
AMSVS400-380	3/8"
AMSVS400-500	1/2"
AMSVS400-580	5/8"
AMSVS400-750	3/4"
AMSVS400-780	7/8"



Vinyl Roof Accessories

Spring 2002

Stucco Accessories

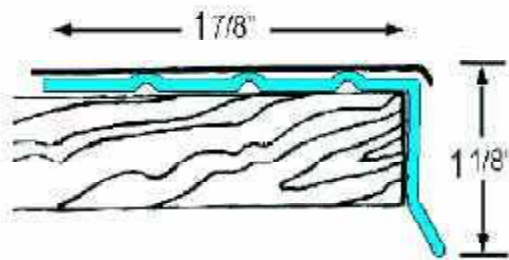

AMICO Vinyl Roof Drip Edge is applied at the edge of the roof to provide continuous edge protection for plywood sheathing, and a drip edge to channel moisture away from the building. This product paints easily to match adjoining fascia.

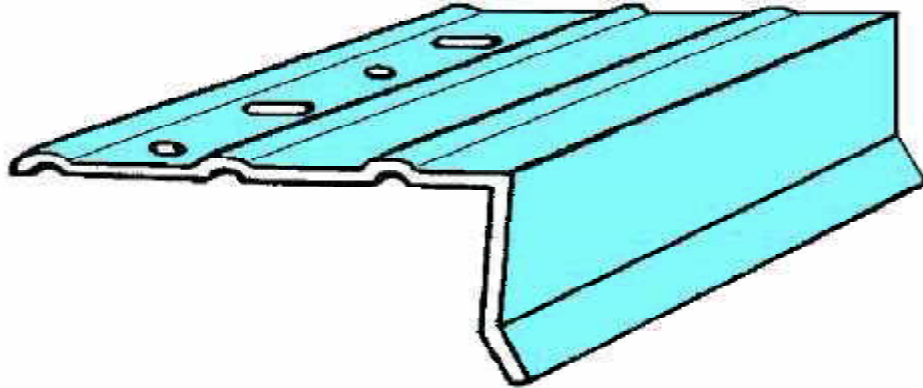

Vinyl Roof Drip Edge

Standard Length: 10 feet

PRODUCT NO.	DIMENSIONS	PCS PER BOX
ROOF DRIP EDGE AMRDE-200	1-7/8"	100



Foundation Weep Screed

Stucco Accessories

Spring 2002

AMICO

Foundation Weep Screed

provides a straight and true screed surface at the base of stucco walls, while allowing excess moisture to escape the back of the stucco membrane. It is important for the water-resistant backing paper and metal lath to overlap the nailing flange of the weep screed in order to guide the water to the exterior. Check with local building codes for the proper clearance above grade. This bead is required by most building codes in the United States.

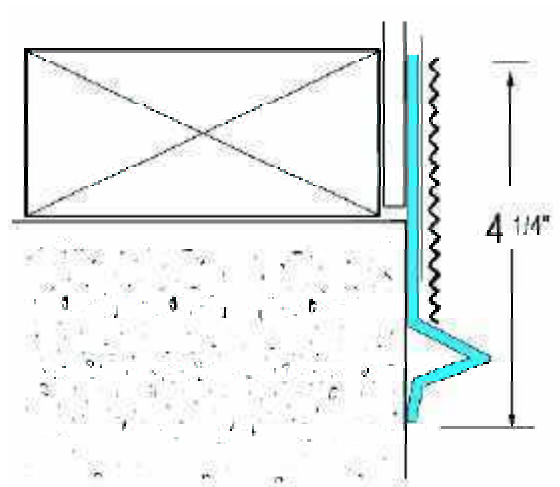

Foundation Weep Screed

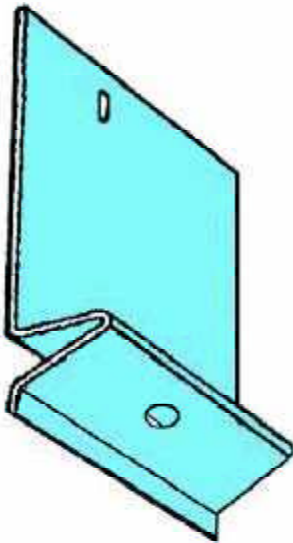

Note: Unpunched Foundation Weep Screed has only a slotted nail hole punchout in the Flange.

Standard Length: 10 feet

PRODUCT NO.	DIMENSIONS	GROUND	PEICES PER BOX
FOUNDATION WEEP SCREED AMFWS-425-380	4 1/4"	3/8"	30
FOUNDATION WEEP SCREED AMFWS-425-500	4 1/4"	1/2"	30
FOUNDATION WEEP SCREED AMFWS-425-580	4 1/4"	5/8"	30
FOUNDATION WEEP SCREED AMFWS-425-750	4 1/4"	3/4"	30
FOUNDATION WEEP SCREED AMFWS-425-780	4 1/4"	7/8"	30

Stucco Accessories Specifications

Spring 2002

Stucco Accessories

PRODUCT DATA AND SPECIFICATION Stucco Accessories

1. PRODUCT NAME

AMICO Rigid Vinyl (PVC) Beads

2. MANUFACTURER

AMICO

Alabama Metal Industries Corporation

P.O. Box 3928

Birmingham, AL 35208

Telephone: 800-366-2642

Facsimile: 205-780-7838

3. DESCRIPTION AND PERFORMANCE

Stucco accessories are manufactured from the highest quality exterior grade vinyl compounds, which are specially formulated for exterior applications. These beads are designed to function at optimum levels in most climatic conditions for many years of service.

Long Lasting:

AMICO bead products will not rust, peel, or affect the plaster mix in any way. Accessories will hold their shape, and stay true and straight when installed properly.

Thru-Color:

The color is solid throughout the product. They are not coated, there is nothing to peel or chip.

Paint Adhesion:

Excellent with no preparation required.

Flammability:

PVC products will not support or spread flames, They are self extinguishing as soon as the flame source is removed, therefore, it will not start a fire. AMICO vinyl bead products meet code requirements for smoke and flame spread as stated in ASTM-E84. Rigid vinyl will not conduct electricity and offers a very low thermal conductivity.

Adhesion of Stucco or Plaster:

All AMICO Vinyl Stucco Beads are provided with adequate perforations to allow complete embedment. This allows all stucco accessories to key to the attached lath for complete bonding of the system.

4. TECHNICAL DATA

Specific technical data may be obtained by calling AMICO technical support at 800/366-2642 ext. 205.

All AMICO Stucco Accessories conforms to:

ASTM C1063

ASTM C-841

ASTM D-4216



Drywall Accessories

Spring 2002

Vinyl Drywall Accessories

Table of Contents

Corner Bead	2 - 5
Corner Bead	2
Arch Corner Bead	3
120° Corner Bead - Wide Angle	3
Bull Nose Corner Bead	4
Bull Nose Corner Caps	4
Bull Nose Arch Corner Bead	5
120° Bull Nose Corner Bead - Wide Angle	5
Bull Nose Inside Corner Bead	5
Casing Bead	6
Bull Nose Casing "J" Bead	6
Drywall Bead	7 - 9
"J" Bead	7
Shadow Line "J" Bead	7
"MJ" Bead	8
"L" Bead	8
Zip Strip Bead	9
Control Joint	10
"F" Channel Reveal	11
Soffit Accessories	12
Soffit Vent Inserts	12
Soffit Vent	12
Specifications	13



Drywall Corner Bead

Vinyl Drywall Accessories

Spring 2002

AMICO Drywall Corner Bead is a strong, durable and straight reinforcement for drywall and veneer plaster corners. All surfaces that receive finish have ridges for better finish adhesion. The nose of this bead acts as a ground and screed to help the applicator achieve the proper depth of finish.

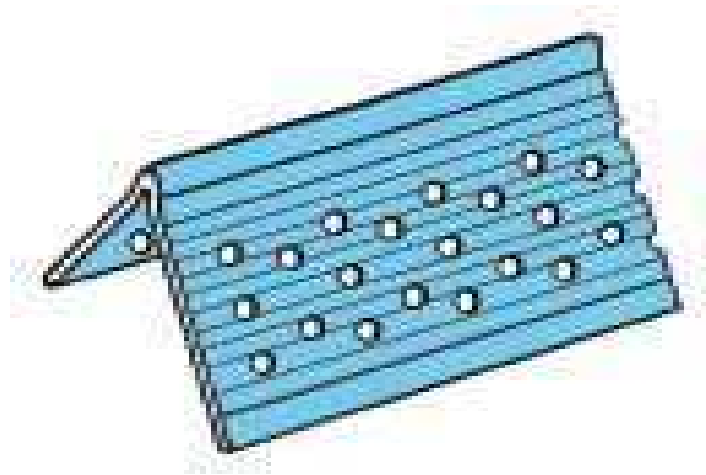

Drywall Corner Bead

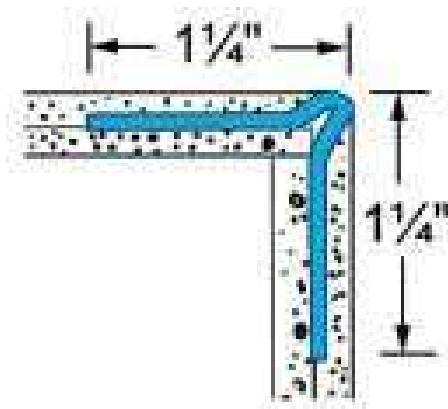

PRODUCT NO.	DIMENSIONS	LENGTH	BOARD THICKNESS	PCS PER BOX
DRYWALL CORNER BEAD AMCB125	1 1/4" x 1 1/4" Perforated Flange	8' & 10'	ALL	100

Drywall Corner Bead

Spring 2002

Vinyl Drywall Accessories



Drywall Arch Corner Bead

AMICO Drywall Arch Corner Bead the drywall arch corner bead is pre-notched to facilitate the curving of this bead during installation. Perforations and ridges on all surfaces that receive finishing compound or veneer assure excellent adhesion. AMICO'S improved notches form more uniform curves than some products currently available.

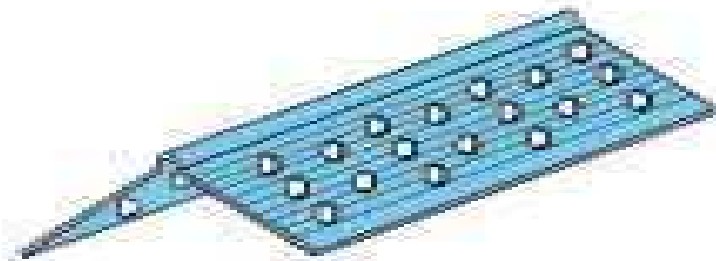

120° Wide Angle Drywall Corner Bead

AMICO 120° Drywall Corner Bead (Wide Angle) has the same characteristics as regular drywall corner bead except that the angle has been opened wider to allow for larger or irregular corners.

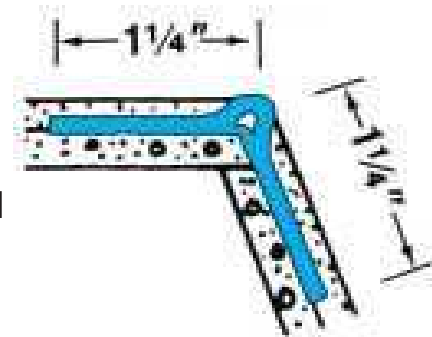

Special Lengths Are Available on Request

PRODUCT NO.	DIMENSIONS	LENGTH	BOARD THICKNESS	PCS PER BOX
DRYWALL ARCH CORNER BEAD AMCB125A	1 1/4" x 1 1/4" Perforated Flange One Flange Slotted	8' & 10'	ALL	50
DRYWALL 120° CORNER BEAD AMCB125WA	1 1/4" x 1 1/4" Perforated Flange	8' & 10'	ALL	50

Bull Nose Corner Bead

AMICO Bull Nose Drywall Corner Bead provides an architecturally attractive corner that is both durable and straight for a softer more rounded appearance.

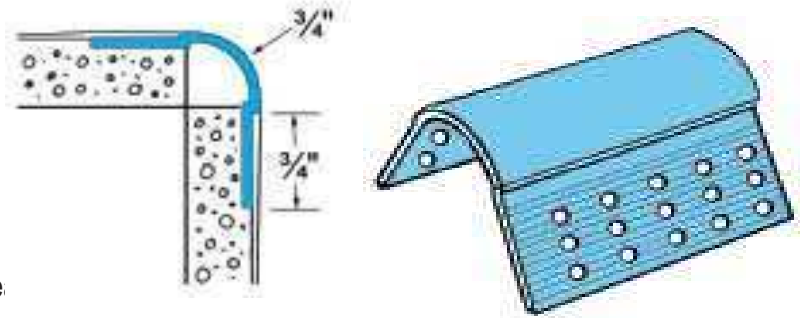

Drywall Bull Nose Corner Be

AMICO Bull Nose Drywall Corner Caps add the perfect finishing touch to compliment the bull nose corner bead system. These caps are great time savers that allow the installer to avoid the costly procedure of mitering corners.

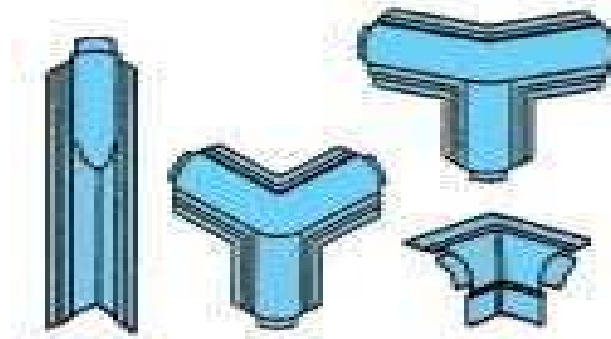

Drywall Bull Nose Corner Caps

PRODUCT NO.	DIMENSIONS	LENGTH	BOARD THICKNESS	PCS PER BOX
DRYWALL BULL NOSE CORNER BEAD AMBNCB-75	3/4" x 3/4" Perforated Flange	8' & 10'	ALL	50
DRYWALL CORNER CAPS AMCC100	1-WAY	N/A	N/A	50
DRYWALL CORNER CAPS AMCC200	2-WAY 90°	N/A	N/A	50
DRYWALL CORNER CAPS AMCC333	3-WAY Off Angle	N/A	N/A	50
DRYWALL CORNER CAPS AMCC750	3-WAY 90°	N/A	N/A	50
DRYWALL BASE TRANSITION AMBTC8590	Cap / Base Transition	N/A	N/A	50

Bull Nose Corner Bead

Spring 2002

Vinyl Drywall Accessories

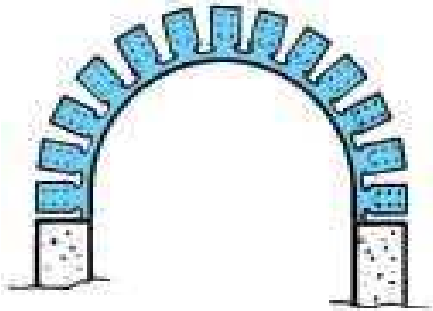

Arch Bull Nose
Corner Bead

AMICO Bull Nose Arch Corner Bead provides strength and durability to curved edges that require a softer more rounded appearance to the corner. The bull nose arch corner bead is pre-notched to easily facilitate the curving of this bead during installation.

120° Bull Nose
Corner Bead

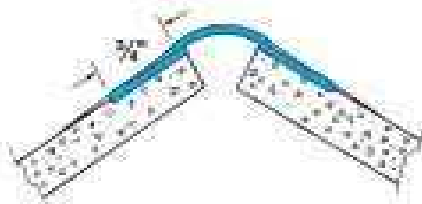

AMICO 120° Bull Nose Corner Bead has the same properties as regular bull nose corner bead except that it offers a wider angle to accommodate larger or irregular corner sizes.

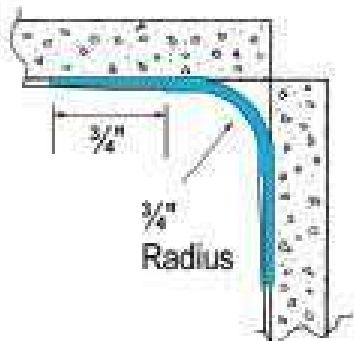

Drywall Bull Nose
Inside Corner Bead

AMICO Bull Nose Inside Corner Bead is used to form smooth and straight bull nose inside corners. This bead once again offers the softer more rounded appearance to the inside corner that will correspond with the rest of the bull nose bead system.

PRODUCT NO.	DIMENSIONS	LENGTH	BOARD THICKNESS	PCS PER BOX
BULL NOSE ARCH CORNER BEAD AMBNCB-- ARCH	3/4" x 3/4" Perforated Flange One Flange Slotted	8' & 10'	ALL	50
120° BULL NOSE CORNER BEAD AMBNWA	3/4" x 3/4" Perforated Flange	8' & 10'	ALL	50
INSIDE CORNER BULL NOSE CORNER BEAD AMBNIC	3/4" x 3/4" Perforated Flange	8' & 10'	ALL	50

Bull Nose Casing "J" Bead

Vinyl Drywall Accessories

Spring 2002

AMICO Bull Nose Casing "J" Bead (Half Round) is the perfect casing to complement installations that incorporate bull nose drywall beads. This bead will fit either 1/2 inch or 5/8 inch gypsum board as an end finish. When used as edging for a dry wall bands, this bead fits only 5/8 inch board. This bead is used to terminate gypsum board at doors, cased openings, and to create decorative bands.

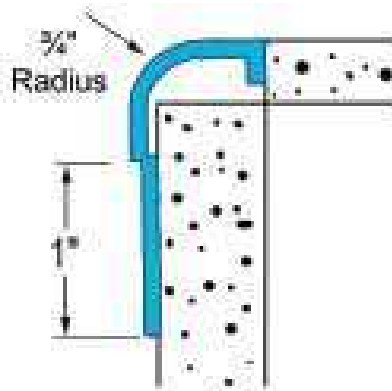

Bull Nose Casing "J" Bead

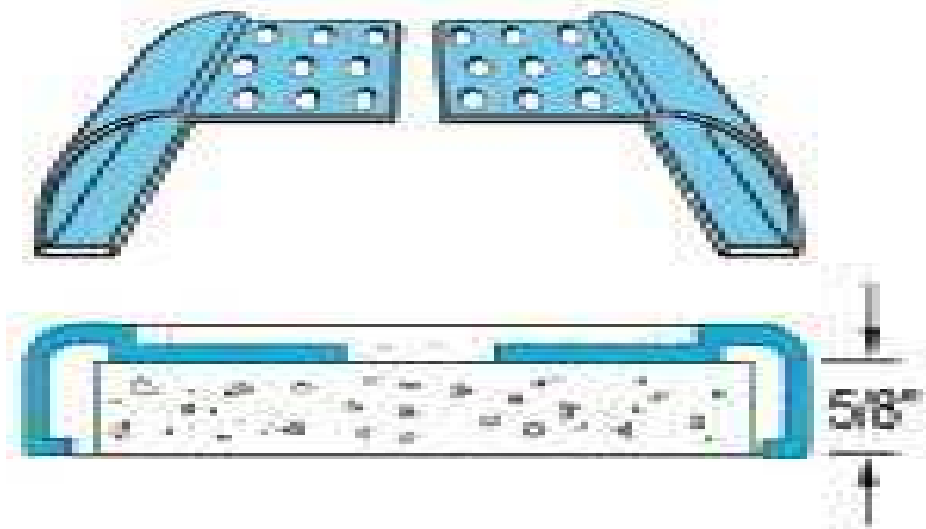

PRODUCT NO.	DIMENSIONS	LENGTH	BOARD THICKNESS	PCS PER BOX
DRYWALL "J" BEAD BULL NOSE CASING AMBNC-100	1 3/4" Overall Width 1" Perforated Flange	10'	All	50

Vinyl Drywall Bead

Spring 2002

Vinyl Drywall Accessories

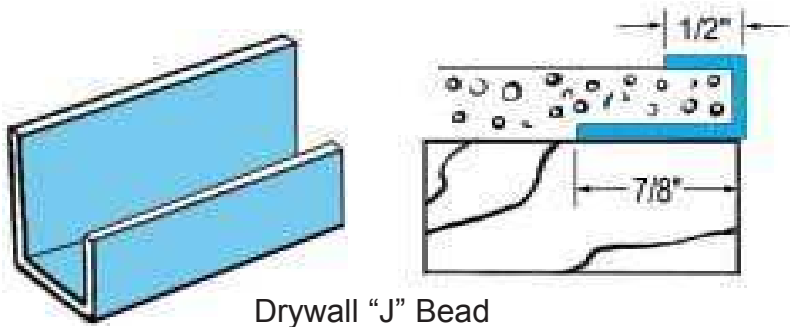

Drywall "J" Bead

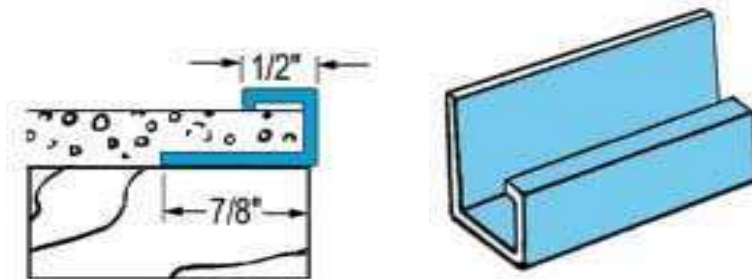

Drywall Shadow Line "J" Bead

AMICO Drywall "J" Bead is used to give a finished appearance to the edge of gypsum board. It has excellent adhesion properties for any type of interior paint. It is often used to isolate gypsum board from dissimilar materials such as aluminum windows. Galvanized beads often react to dissimilar metals such as aluminum causing premature corrosion.

AMICO Shadow Line "J" Bead creates a shadow along the finished edge of the gypsum board to provide a decorative effect.

Note: Special Lengths Are Available Upon Request.

Vinyl Drywall Bead

AMICO Drywall "MJ" Bead (Perforated)

covers and protects the edges of gypsum wallboard. Perforations and ridges are placed on all surfaces that receive veneer or finishing compound assure excellent adhesion.

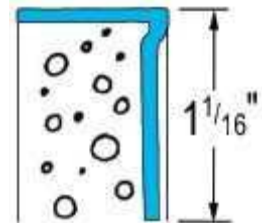
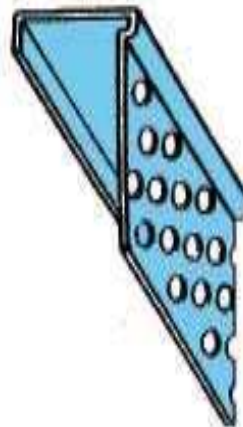

Drywall "MJ" Bead

AMICO Drywall "L" Bead (Perforated)

is used to protect the edges of gypsum wallboard. Perforations and ridges placed on all surfaces that receive finishing compound or veneer assure excellent adhesion.

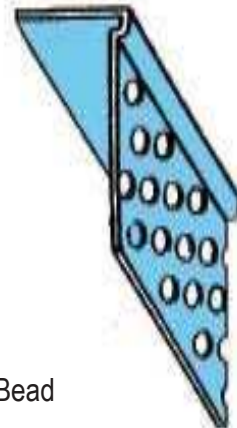
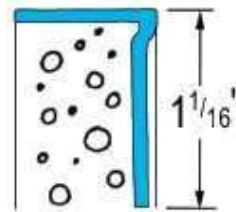

/Drywall "L" Bead

Note: Special Lengths Are Available Upon Request.

Standard Length 10 Feet

PRODUCT NO.	DIMENSIONS	BOARD THICKNESS	PCS PER BOX
DRYWALL "MJ" BEAD Perforated Flange AMMJB50	1-1/16" Width 1/4" Return	1/2"	50
DRYWALL "MJ" BEAD Perforated Flange AMMJB58	1-1/16" Width 1/4" Return	5/8"	50
"L" STOP BEAD Perforated Flange AMSB50	1-1/8" Width	1/2"	50
"L" STOP BEAD Perforated Flange AMSB58	1-1/8" Width	5/8"	50

Drywall Zip Strip Bead

Spring 2002

Vinyl Drywall Accessories

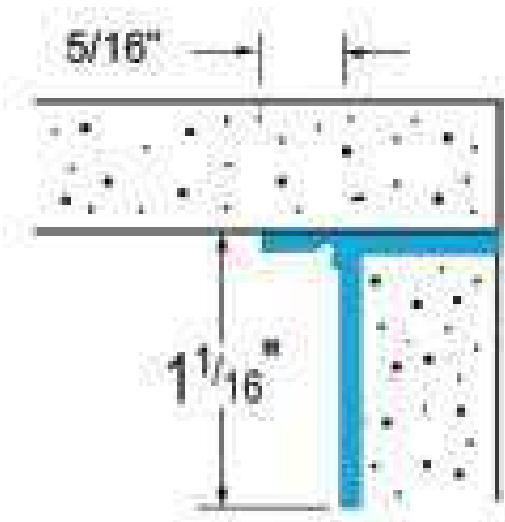

AMICO "ZIP STRIP" Ceiling "L" Trim has a removable masking strip that allows this bead to be finished without staining the adjacent ceiling. Perforations and ridges placed on all surfaces that receive finishing compound or veneer plaster assures excellent adhesion.

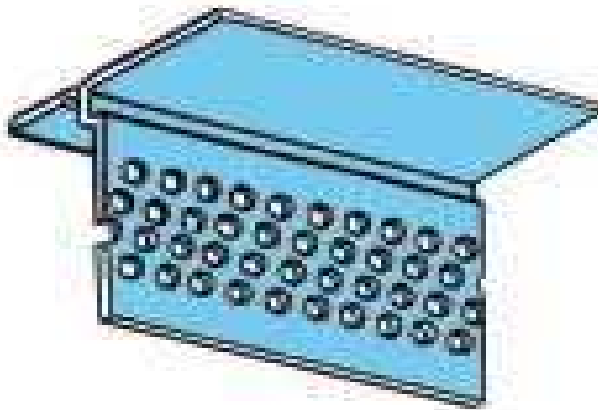

Standard Length 10 Feet

PRODUCT NO.	DIMENSIONS	BOARD THICKNESS	PCS PER BOX
"ZIP STRIP" CEILING "L" TRIM AMZIP-50	1-1/16" Width Perforated Flange 5/16" Removable Leg	1/2"	50
"ZIP STRIP" CEILING "L" TRIM AMZIP-58	1-1/16" Width Perforated Flange 5/16" Removable Leg	5/8"	50

Drywall Control Joint

Vinyl Drywall Accessories

Spring 2002

AMICO

Drywall Control Joint Deep "V"
(with Removable Tape)

is designed to help relieve stress in large areas of drywall or veneer plaster installations. Perforations and ridges on all surfaces that receive finishing compound or veneer assure excellent adhesion. Provides a 1/16" ground.

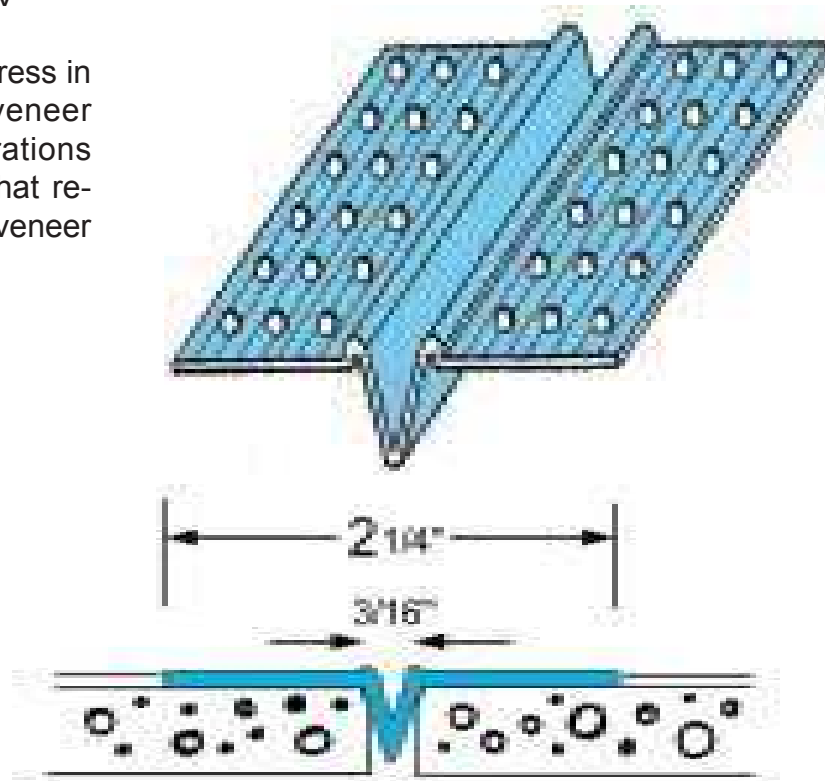

Drywall Vinyl Control Joint

Standard Length 10 Feet

PRODUCT NO.	DIMENSIONS	LENGTH	BOARD THICKNESS	PCS PER BOX
CONTROL JOINT With Removeable Tape AMDCJV16	2 1/4" Width Perforated Flange 3/16" Reveal	10'	ALL	60

Drywall Reveals

Spring 2002

Vinyl Drywall Accessories

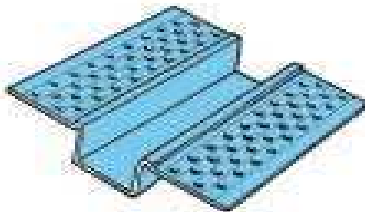
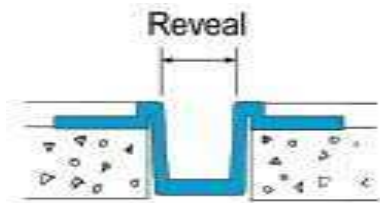

Drywall Vinyl Reveal

AMICO Drywall Reveal are used to provide an architectural or decorative relief in gypsum panels. Reveals are easily installed to provide a straight reveal in either 1/2" or 5/8" gypsum board.

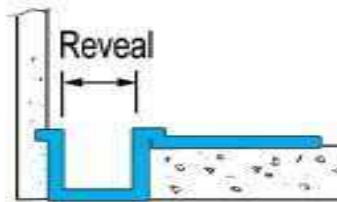
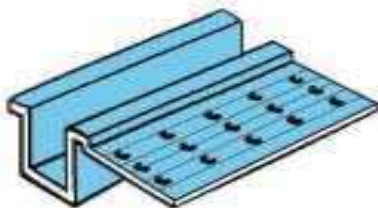

Drywall Vinyl "F" Channel Reveal

AMICO "F" Channel Reveal are designed to provide an architectural relief in drywall surfaces at wall and ceiling terminations, or at junctures with dissimilar material.

Standard Length 10 Feet

PRODUCT NO.	REVEAL DIMENSIONS	LENGTH	BOARD THICKNESS	PCS PER BOX
DRYWALL REVEAL AMDWR-50	1/2"	8' & 10'	ALL	35
DRYWALL REVEAL AMDWR-75	3/4"	8' & 10'	ALL	35
DRYWALL REVEAL AMDWR-100	1"	8' & 10'	ALL	35
DRYWALL "F" CHANNEL REVEAL AMDFR-50	1/2"	10'	ALL	35
DRYWALL "F" CHANNEL REVEAL AMDFR-75	3/4"	10'	ALL	35
DRYWALL "F" CHANNEL REVEAL AMDFR-100	1"	10'	ALL	35

Soffit Vent Inserts

AMICO Soffit Vent Inserts

2", 3" & 4" Soffit Vent Inserts provide continuous attic ventilation through the perforated surface. Shoulders are a full 3/8 inch deep to protect sheathing edges and to provide a caulking surface. This product is often installed directly to the bottom of the joist, prior to the installation of the sheathing. This provides a continuous airflow along the entire length of the soffit.

AMICO Soffit Vent

for Sheathing provides continuous attic ventilation like our soffit insert, while offering better protection to the edges of sheathing, this may eliminate the need for caulking in some cases.

Standard Length 10 Feet

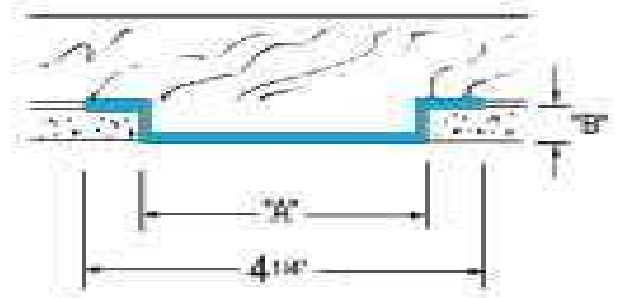

Drywall Soffit Vent Inserts

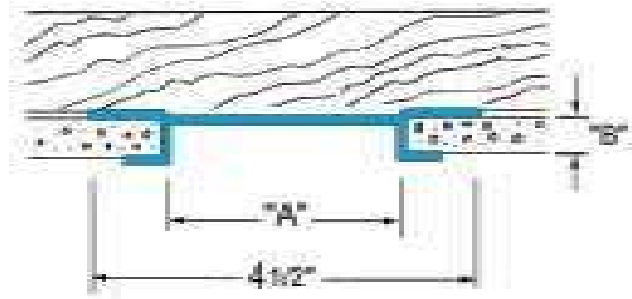

Drywall Soffit Vent

Vinyl Drywall Accessories Specifications

Spring 2002

Vinyl Drywall Accessories

PRODUCT DATA AND SPECIFICATION Drywall Accessories

1. PRODUCT NAME

AMICO Rigid Vinyl (PVC) Beads

2. MANUFACTURER

AMICO

Alabama Metal Industries Corporation

P.O. Box 3928

Birmingham, AL 35208

Telephone: 800-366-2642

Facsimile: 205-780-7838

3. DESCRIPTION AND PERFORMANCE

Drywall accessories are manufactured from the highest quality exterior grade vinyl compounds, which are specially formulated for exterior applications. These beads are designed to function at optimum levels in most climatic conditions for many years of service.

Long Lasting:

AMICO bead products will not rust, peel, or affect the plaster mix in any way. Accessories will hold their shape, and stay true and straight when installed properly.

Thru-Color:

The color is solid throughout the product. They are not coated, there is nothing to peel or chip.

Paint Adhesion:

Excellent with no preparation required.

Flammability:

PVC products will not support or spread flames, They are self extinguishing as soon as the flame source is removed, therefore, it will not start a fire. All AMICO vinyl bead products meet code requirements for smoke and flame spread as stated in ASTM-E84. Rigid vinyl will not conduct electricity and offers a very low thermal conductivity.

Adhesion of Drywall Accessories:

All AMICO Vinyl Drywall Beads are provided with adequate perforations to allow complete embedment. Many drywall products have serrations on the flange. This aids in the adhesion of the finish to the drywall accessory. This allows all drywall accessories to key to the attached gypsum board for complete bonding of the system. Perforations allow the finishing compound to penetrate the bead and allow the complete bonding of the joint compound.

4. TECHNICAL DATA

Specific technical data may be obtained by calling AMICO technical support at 800/366-2642 ext. 205.

All AMICO Drywall Accessories conform to:

ASTM C-844

ASTM C-1047

ASTM D-1784

EIFS Accessories

Spring 2002

EIFS Accessories

Table of Contents

Corner Beads	2
Corner Bead	2
Starter Strips and Edge Trim	3 - 7
Window & Door Drip Edge	3
Starter Strip with Drip Edge	4
Starter Strip without Drip Edge	5
Starter Track Casing Bead without Drip Edge	6
Angled Starter Track Casing with Drip Edge	7
Expansion Joints	8 - 9
Expansion Joint - Deep "V" 1/16" Finish	8
Expansion Joint - Deep "V" 1/4" Finish	9
Miscellaneous Accessories	10 - 13
Angled Surface Drip Bead	10
Sill Wedge	11
Soffit Vent	12
Specifications	13



EIFS Corner Bead

AMICO EIFS Corner Bead produces straight and durable corners while allowing for most degrees of finish thickness. It also eliminates the need for the time consuming task of rasping corners to achieve a smooth, plumb, and level corner. The absence of a rounded nose allows the EIFS corner bead to lie perfectly flat on the two adjoining walls that form the corner.

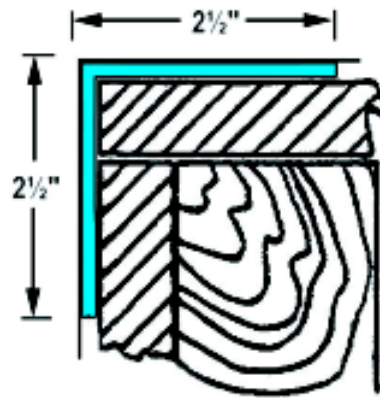
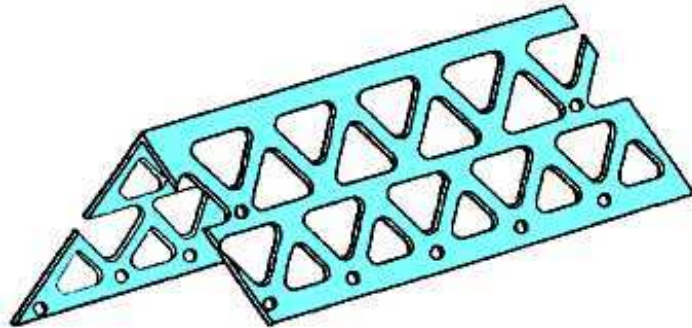

EIFS Corner Bead

Standard Length: 10 Feet

PRODUCT NO.	DIMENSIONS	GROUND	PCS PER BOX
EIFS CORNER BEAD AMX4	2 1/2" x 2 1/2"	ANY	50

EIFS Window & Door Drip Edge

Spring 2002

EIFS Accessories

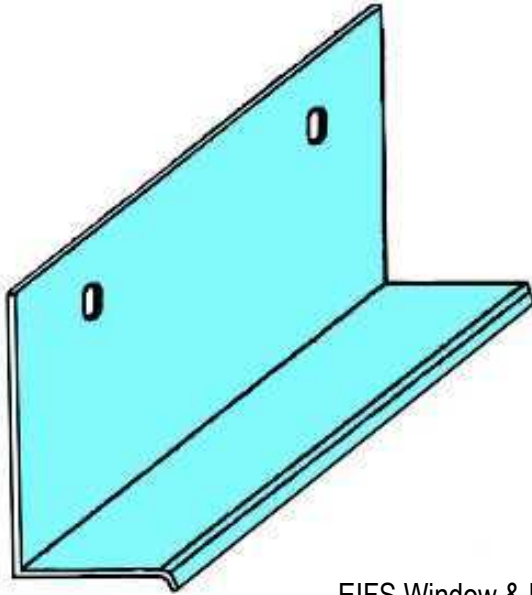

EIFS Window & Door Drip Edge

AMICO Window & Door Drip Edge is used to provide added protection for system edges at the top of windows and doors. This product has a drip edge which helps direct water away from the building. A two-inch rear flange is provided.

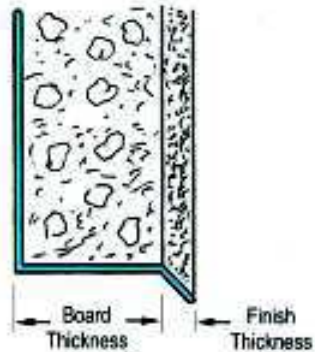

Standard Length: 10 Feet

PRODUCT NO.	BOARD THICKNESS	FINISH THICKNESS	PIECES PER BOX
WINDOW & DOOR DRIP EDGE AMWDE75-16	3/4"	1/16"	100
WINDOW & DOOR DRIP EDGE AMWDE100-16	1"	1/16"	100
WINDOW & DOOR DRIP EDGE AMWDE150-16	1½"	1/16"	80
WINDOW & DOOR DRIP EDGE AMWDE200-16	2"	1/16"	75
WINDOW & DOOR DRIP EDGE AMWDE100-25	1"	1/4"	70

EIFS Starter Strip

AMICO EIFS Starter Strip (with Drip Edge)

is used to provide a shelf or edge support for foam board and EIFS finish. This bead often allows the installer to dispense with the necessity to back wrap and finish the bottom edge of the board (check with EIFS manufacturers to assure that this is allowed with their system). The bottom leg and lip serves as a drip edge to funnel moisture away from the wall or foundation. This bead is usually installed at the bottom of framed walls. Excellent adhesion of EIFS finishes and paint can be expected with all AMICO vinyl EIFS beads.

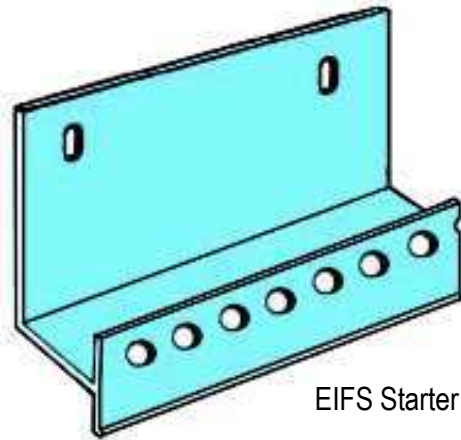
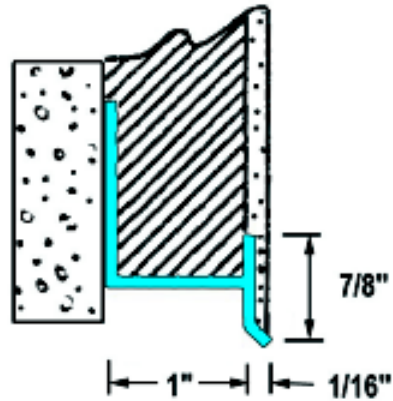

EIFS Starter Strip with Drip Edge

Standard Length: 10 Feet

PRODUCT NO.	DIMENSIONS	BOARD THICKNESS	PCS PER BOX
STARTER STRIP With Drip Edge AMSS100-16	2" x 1"	1"	40

EIFS Starter Casing Strip

Spring 2002

EIFS Accessories

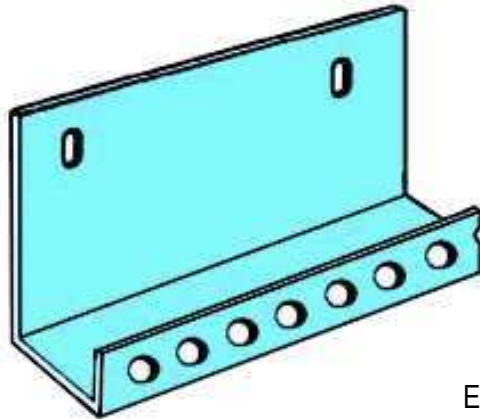
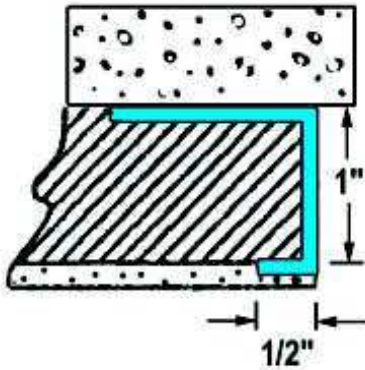

EIFS Starter Strip with Dripout Edge

AMICO EIFS Starter Casing Strip (Without Drip Edge)

is used to provide a shelf or edge protection for foam board and EIFS finish, but does not have a drip edge. It protects the edge of the board and finish from damage. This bead often allows the installer to dispense with the necessity of back wrapping and finishing the edge of the board (check with EIFS manufacturers to assure that this is allowed with their system). It is usually installed on edges other than at the bottom of the wall. Excellent adhesion of EIFS finishes and paint can be expected with all AMICO vinyl EIFS beads.

Standard Length: 10 Feet

PRODUCT NO.	DIMENSIONS	BOARD THICKNESS	PCS PER BOX
STARTER CASING STRIP Without Drip Edge AMSCS100-16	2" x 1"	1"	40

EIFS Starter Track Casing

AMICO EIFS Starter Track/Casing (Without Drip Edge) and with Drainage Holes can be installed at the bottom of the wall as a starter track, but is usually installed around the perimeter of the wall as a casing to protect the edge of the foam board and finish from damage and the elements. This product does not have a drip edge. Ridges and perforations on the face of this bead aid in finish adhesion. Excellent adhesion of EIFS finishes and paint can be expected with all AMICO vinyl EIFS beads.

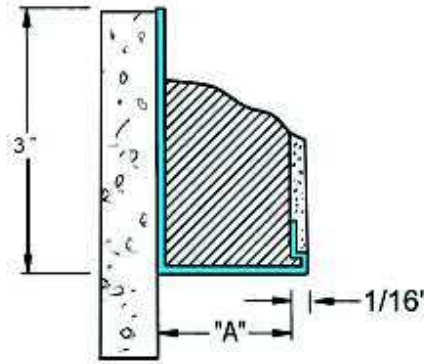

EIFS Starter Track Casing Bead with Drainage Holes

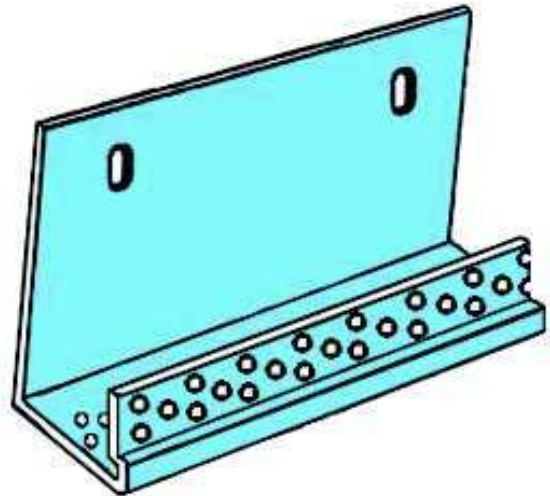

Standard Length: 10 Feet

PRODUCT NO.	BOARD THICKNESS "A"	PCS PER BOX
STARTER TRACK CASING Without Drip Edge AMST-1000	1"	25
STARTER TRACK CASING Without Drip Edge AMST-1500	1½"	20
STARTER TRACK CASING Without Drip Edge AMST-2000	2"	15

EIFS Angled Starter Track

Spring 2002

EIFS Accessories

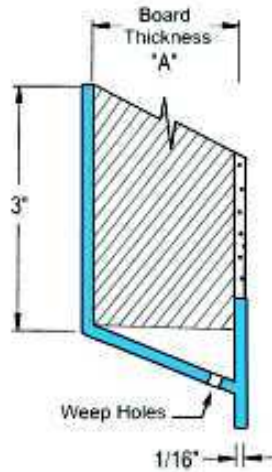
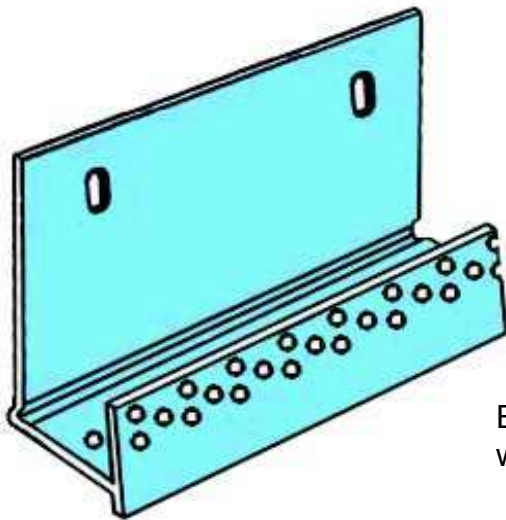

AMICO Angled Starter Track Casing with Drip Edge and with Drainage Holes is typically installed at the bottom of the wall as a starter track to protect the bottom edge of the foam board and finish from damage and the elements. Ridges and perforations on the face of this bead aid in finish adhesion. The angled channel help funnel accumulated moisture to the drainage openings in the track which allows this moisture to exit.

EIFS Angled Starter Track with Drip Edge and Drainage Holes

Standard Length: 10 Feet

PRODUCT NO.	BOARD THICKNESS "A"	PCS PER BOX
ANGLED STARTER TRACK CASING With Drip Edge AMSTA-1000	1"	25
ANGLED STARTER TRACK CASING With Drip Edge AMSTA-1500	1½"	20
ANGLED STARTER TRACK CASING With Drip Edge AMSTA-2000	2"	15

EIFS Expansion Joint

AMICO EIFS Expansion Joint (Deep "V") for 1/16" Ground with Removable Tape is manufactured with a deep center "V" which allows for more movement than would normally be possible with one that matched the thickness of the finish coat. This bead requires that a space be left between sheets of foam, or routed into the foam board to accommodate the deep center "V". All surfaces that receive finish have ridges for better adhesion.

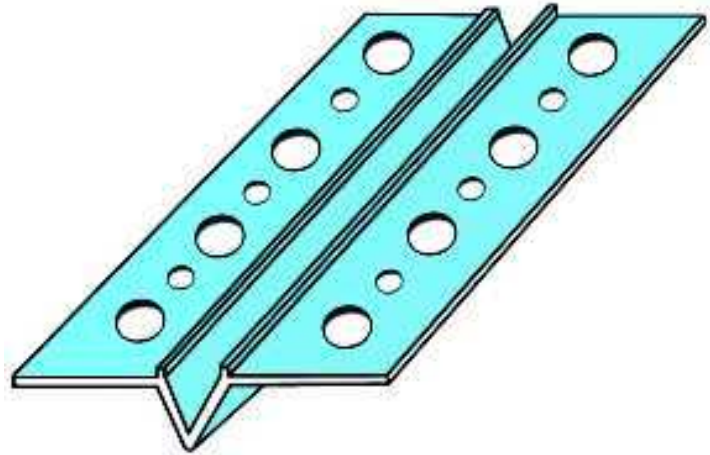

1/16" ground is typically used with EIFS soft coat systems.

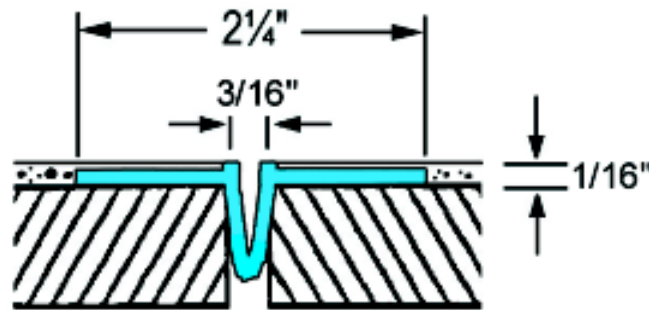

EIFS 1/16" Expansion Joint

Standard Length: 10 Feet

PRODUCT NO.	DIMENSIONS	FINISH THICKNESS	PCS PER BOX
EXPANSION JOINT Deep "V" AMCJV-160	2 1/4" Widths	1/16"	60

EIFS Expansion Joint

Spring 2002

EIFS Accessories

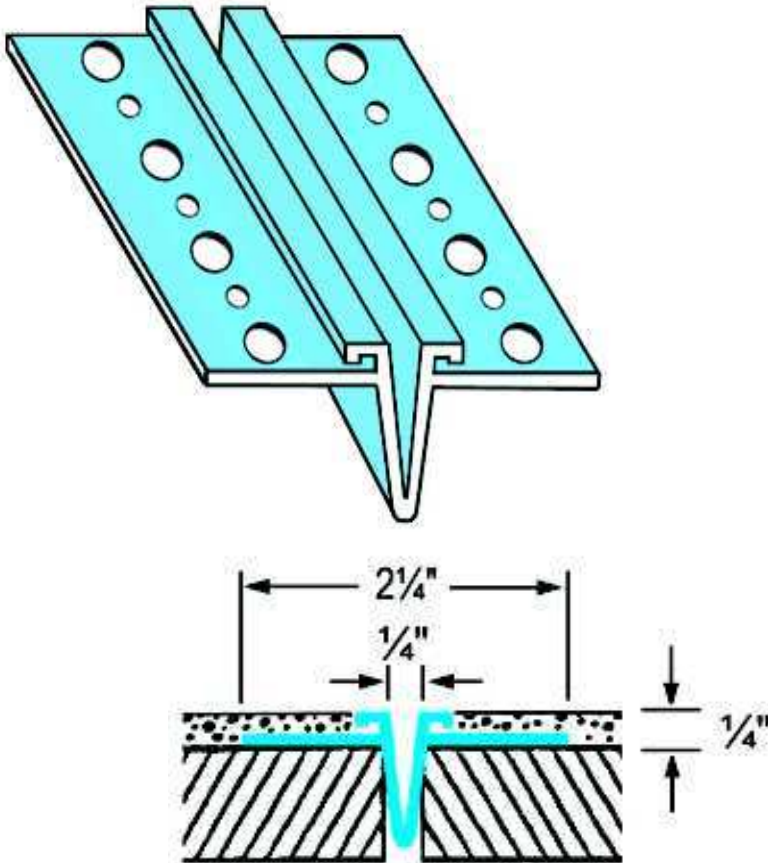

EIFS 1/4" Expansion Joint

AMICO EIFS Expansion Joint (Deep "V") for 1/4" Ground with Removable Tape is manufactured with a deep center "V" which allows for more movement than would normally be possible with one that matched the thickness of the finish coat. This bead requires that a space be left between sheets of foam, or routed into the foam board to accommodate the deep center "V". All surfaces that receive finish have ridges for better adhesion.

1/4" ground is typically used with some 1-coat stucco and hard coat EIFS systems.

Standard Length: 10 Feet

PRODUCT NO.	DIMENSIONS	FINISH THICKNESS	PCS PER BOX
EXPANSION JOINT Deep "V" AMCJV-250	2 1/4" Widths	1/4"	35

EIFS Angled Surface Drip Bead

EIFS Accessories

Spring 2002

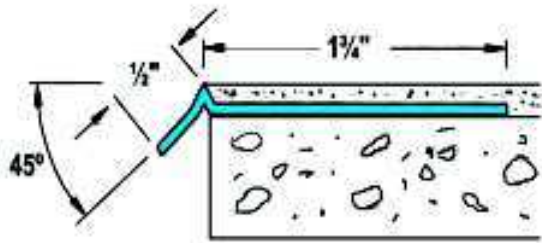

AMICO Angled Surface Drip Bead can be installed around windows, doors, or any termination of the system as a backer for finish or sealant application. All surfaces that receive finish have ridges for better adhesion. The angled flange serves as a drip edge. A built in 1/8-inch ground is provided.

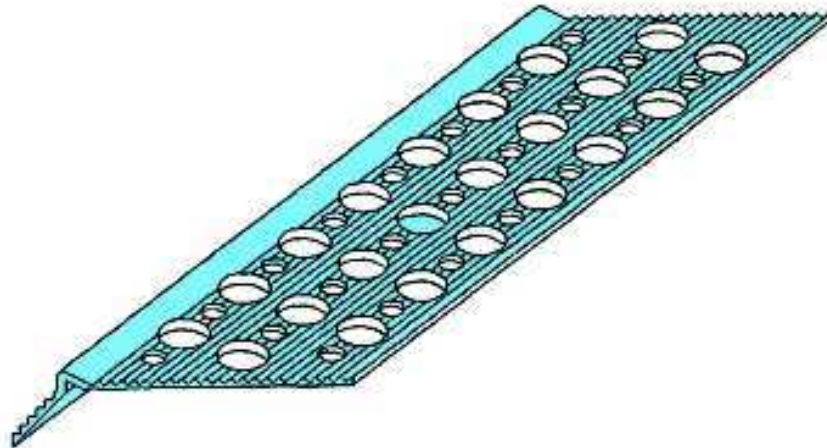

EIFS Angled Surface Drip Bead

Standard Length: 10 Feet

PRODUCT NO.	DIMENSIONS	GROUND	PCS PER BOX
ANGLED SURFACE DRIP BEAD AMASDB	1-3/4" Flange	1/8"	100

EIFS Sill Wedge

Spring 2002

EIFS Accessories

AMICO EIFS Sill Wedge is component of a water management system, which provides a sloped surface on which the window frame can rest. This will provide a positive sloping surface. The sill wedge helps to direct unwanted moisture towards the face of the moisture resistant barrier, and away from the wall cavity.

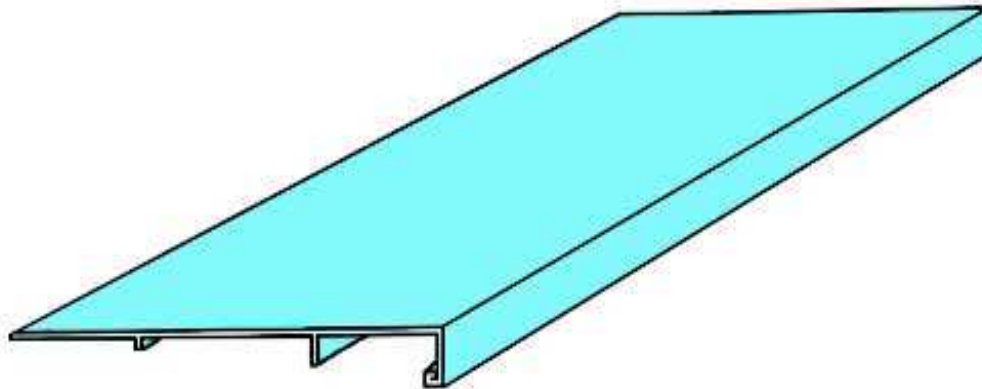
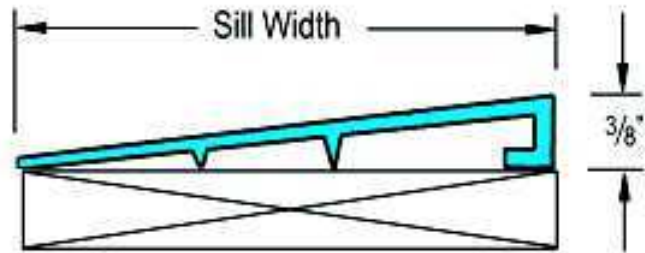

EIFS Sill Wedge

Standard Length: 10 Feet

PRODUCT NO.	DIMENSIONS	HEIGHT	PCS PER BOX
SILL WEDGE AMSW-378	3-7/8" Width	3/8"	30
SILL WEDGE AMSW-578	5-7/8" Width	3/8"	30

EIFS Soffit Vent

AMICO EIFS Soffit Vent

is designed to accommodate one-inch foam insulation board, while providing a full three inches of vented area. This provides 14 square inches of open area per lineal foot. All surfaces that receive finish have ridges for better adhesion. The top flanges are extra wide, and have a 1/8-inch ground to accommodate the application of the proper thickness of finish.

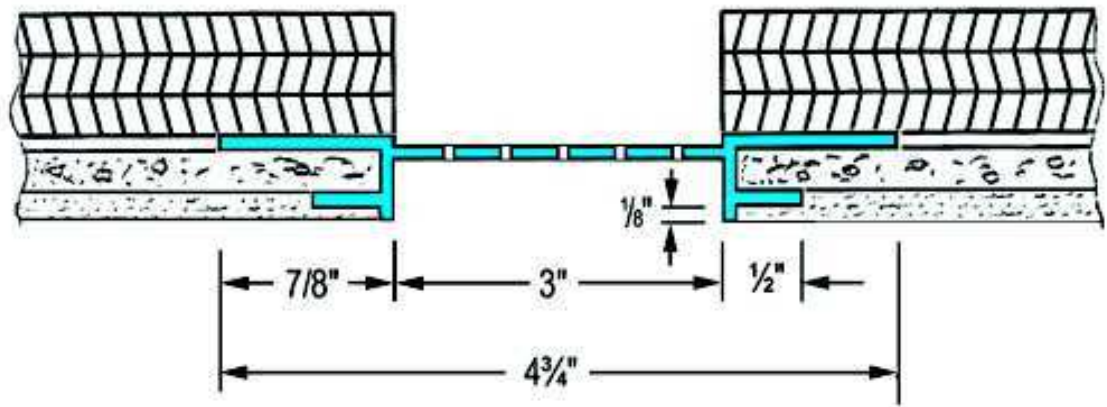
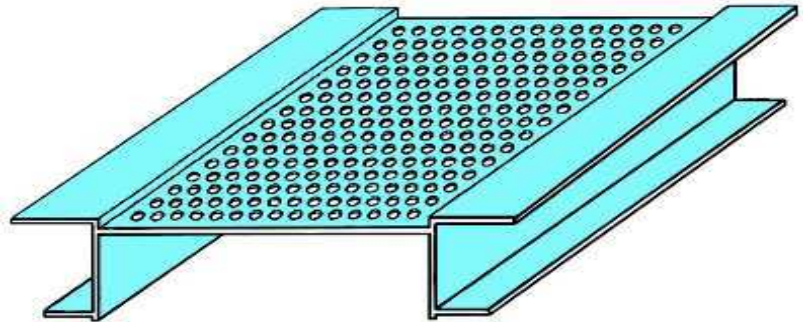

EIFS Soffit Vent

Standard Length: 10 Feet

PRODUCT NO.	DIMENSIONS	VENT OPENING	BOARD THICKNESS	PCS PER BOX
SOFFIT VENT AMFBSVE-100	4 3/4" Overall Width	3"	1"	12

EIFS Specifications

Spring 2002

EIFS Accessories

PRODUCT DATA AND SPECIFICATION

Exterior Insulation and Finish Systems

EIFS Accessories

1. PRODUCT NAME

AMICO Rigid Vinyl (PVC) Beads

2. MANUFACTURER

AMICO

Alabama Metal Industries Corporation

P.O. Box 3928

Birmingham, AL 35208

Telephone: 800-366-2642

Facsimile: 205-780-7838

3. DESCRIPTION AND PERFORMANCE

EIFS accessories are manufactured from the highest quality exterior grade vinyl compounds, which are specially formulated for exterior applications. These beads are designed to function at optimum levels in most climatic conditions for many years of service.

Long Lasting:

AMICO bead products will not rust, peel, or affect the plaster mix in any way. Accessories will hold their shape, and stay true and straight when installed properly.

Thru-Color:

The color is solid throughout the product. They are not coated, there is nothing to peel or chip.

Paint Adhesion:

Excellent with no preparation required.

Flammability:

PVC products will not support or spread flames, They are self extinguishing as soon as the flame source is removed, therefore, it will not start a fire. AMICO vinyl bead products meet code requirements for smoke and flame spread as stated in ASTM-E84. Rigid vinyl will not conduct electricity and offers a very low thermal conductivity.

Adhesion of EIFS Finishes:

All AMICO Vinyl EIFS Beads are provided with adequate perforations to allow complete embedment. This allows all EIFS accessories to key to the attached foam for complete bonding of the system.

4. TECHNICAL DATA

Specific technical data may be obtained by calling AMICO technical support at 800/366-2642 ext. 205.

All AMICO EIFS Accessories conforms to:

ASTM C-1063

ASTM C-1397 (PS49)

ASTM D-4216



AMICO *

**Stucco Beads
Drywall Beads
EIFS Beads
Vinyl Beads for
Plaster & Stucco
Applications.**

DATA

PRODUCT NAME

AMICO Rigid Vinyl (PVC) Beads Stucco Beads/
Drywall Beads/Veneer Beads/EIFS Beads

MANUFACTURER

Alabama Metal Industries Corporation (AMICO)
3245 Fayette Avenue
Birmingham, AL 35208
Phone: 205/787-2611
800/366-2642



PRODUCT DESCRIPTION

AMICO extruded vinyl beads are divided into the following groups: Stucco, Drywall/Veneer, EIFS, and Roofing. AMICO vinyl beads are manufactured from the highest quality vinyl compounds. These compounds are specially formulated for each product group individually, in order to provide products that perform optimally for specific applications. In other words, exterior products are formulated for exterior applications and interior products are formulated for interior applications.

Stucco products include corner beads, casing beads, expansion/control joints, foundation weep screeds, banding beads, reveals and soffit screeds. Drywall products include corner beads, "zipstrip" ceiling trim, and beads, bullnose corner beads, bullnose arch, soffit vents, "J" beads, "L" beads, reveals and expansions. EIFS products include

starter strips, casing, window drip edge, and corner bead. Roofing products include roof drip edge. AMICO is constantly planning and developing new products. Therefore, in an effort to keep up with industry demands, AMICO will be adding new products on a regular basis.

Composition: All exterior products (Stucco, EIFS, & Roof Drip Edge) are extruded from the highest quality exterior grade vinyl compounds, which are especially formulated for exterior applications. All interior products (Drywall) are produced from the highest quality interior grade vinyl, which is designed to be tough and durable for interior applications.

All AMICO vinyl products are long lasting and durable. They will not rust or peel and the color is solid throughout the product. AMICO vinyl products exhibit

excellent paint adhesion, with advance preparation.

AMICO beads will hold their shape, and stay true and straight when installed properly. AMICO vinyl accessories will not support or spread flame. They are self-extinguishing as soon as the heat source is removed; therefore they will not start a fire. Rigid vinyl will not conduct electricity and offers very low thermal conductivity.

TECHNICAL DATA

All material conforms to ASTM C 840, C 844, C 841, C 1047 and D 1784 for interior products, or ASTM D 4216 and C 1063 for exterior products.

INSTALLATION

Methods of Cutting: Vinyl beads can be cut with hand snips or for larger products with a fine toothed saw, such as a hacksaw.

Methods of Attachment: Vinyl drywall beads are usually stapled in place using 9/16" type G staples, but drywall nails or screws may be used. Do not sink these too deep as they may deform the nailing flange. Beads should be attached at the top on one side, then on the bottom of the same side after bead is straightened. Attach one side in its entirety before attaching the other side. If the bead is attached horizontally, the top flange should be completely attached before attaching the bottom flange. ALL BUTT JOINTS, INTERSECTIONS, AND ENDS SHOULD BE CAULKED.

Vinyl stucco beads may be attached by the use of lathing nails, lath screws, or wire ties. Where temperatures may vary greatly during construction, plaster beads should be nailed directly to studs, rather than wire tied to lath. Never clean out expansion joints with sharp implements, such as trowels. Such implements may score or tear the joint resulting in a leak. Removable tape is provided to keep expansion joints clean during the finishing process and should be removed after the finish is in place. All AMICO vinyl stucco beads are provided with adequate perforations to allow for complete embedment and key-

ing of stucco or finishing compound. Perforations, as well as surface ridges are provided in drywall and veneer beads to allow the finishing compound to penetrate the bead and allow for complete bonding of the joint compound or veneer plaster.

AVAILABILITY AND COST

AMICO vinyl beads are sold nationally through a network of dealers and distributors. To locate the dealer nearest you, call 1-800/366-2642. Current cost may be obtained by contacting your nearest dealer.

WARRANTY

These AMICO products are warranted to the finished product specification and to the physical and chemical properties of the raw material used if requested prior to the sale and expressly stated by AMICO and AMICO's supplier.

This warranty is limited to one year from the date the product is used for its intended purpose.

The information herein is accurate and reliable to the best of our knowledge. AMICO has no control over installation, workmanship, accessories, complementary materials, or conditions of ap-

plication and therefore, cannot be responsible for these areas of product performance.

THE EXCLUSIVE REMEDY FOR ANY BREACH OF WARRANTY IS REPLACEMENT OF THE PRODUCT OR A REFUND OF THE PURCHASE PRICE AT AMICO'S OPTION. THE ABOVE STATED WARRANTIES AND REMEDY IS THE ONLY WARRANTY MADE AND AMICO DISCLAIMS ANY OTHER WARRANTY WHETHER EXPRESSED OR IMPLIED, INCLUDING BUT NOT LIMITED TO THE IMPLIED WARRANTIES OF MERCHANTABILITY AND FITNESS FOR A PARTICULAR PURPOSE.

MAINTENANCE

Vinyl beads should be given reasonable protection from the elements prior to installation. Caution should be taken to avoid damage to the product and also care should be given not to store anything on top of these products that might deform their shape prior to usage.

TECHNICAL SERVICES

Technical service is available form



ALABAMA METAL INDUSTRIES CORPORATION
3245 Fayette Ave - Birmingham, AL 35208
800-366-2642 - FAX 205-780-7838