

CertainTeed

Decorative Trim

Vinyl Carpentry™ & Restoration Millwork™



CertainTeed 

Quality made certain. Satisfaction guaranteed.™

Decorative Trim



55802
3-1/2" Corner Block



55803
Rosette



55804
Crown Molding



55805
Crown Molding Cap



55807
Cornice Molding



55808
Cornice Molding
Cornerpost Cap



55815
Finish Board



55814
Band Board
with foam insert



55812
Cornice
Receiver



55813
2-1/2" Window
& Door Casing

Functional Trim



56901
Trim Coil



56903
Dual Undersill Trim



56904
Undersill Trim



56912
Cedar Impressions
Undersill Trim



56907
Drip Cap



56908
Vinyl Fascia

Soffit Trim



52501
Soffit Cove Trim



52506
3/4" F-Channel



52502
5/8" F-Channel



52503
Deluxe F-Channel



52504
1/2" H-Bar



52505
3/8" H-Bar

J-Channel



50306
3/8" J-Channel



50307
7/16" J-Channel



50305
1/2" J-Channel



50303
3/4" J-Channel



50304
3/4" Flexible
J-Channel







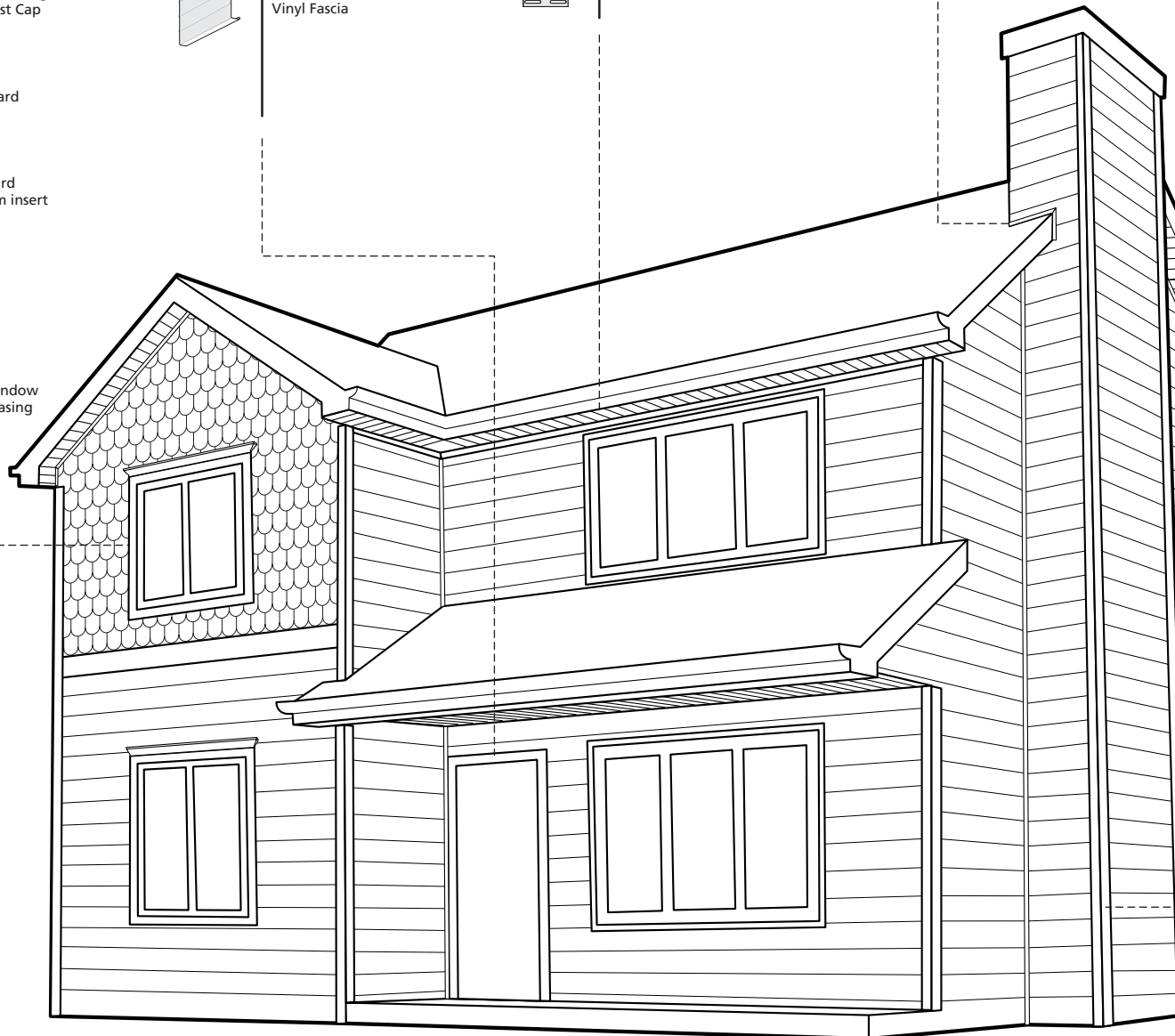

50302
1" J-Channel





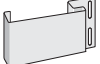











50301
1-1/4" J-Channel









Lineals









	54709 3-1/2" Snap-On Lineal
	54706 3-1/2" Lineal
	54712 5" Lineal
	54707 3-1/2" Lineal with foam insert
	54713 3-1/2" Double Channel Lineal
	54714 5" Double Channel Lineal

Corner Systems

	51452 7/16" Cornerpost 10' Woodgrain
	51401 3/4" Cornerpost 10' Woodgrain
	51402 3/4" Cornerpost 12' Woodgrain
	51404 3/4" Cornerpost 10' Matte
	51409 1" Cornerpost 10' Woodgrain
	51412 1-1/4" Insulated Cornerpost 10' Woodgrain
	51436 3/4" Inside Cornerpost Matte
	51449 3/4" Inside Cornerpost Woodgrain
	51446 1-1/4" Inside Cornerpost Matte
	51448 NEW D7" Perfection Mitered Cornerpost
	51430 T5" Perfection Mitered Cornerpost
	51451 D7" Staggered Perfection Mitered Cornerpost
	51450 D7" Rough-Split Mitered Cornerpost
	51432 D9" Rough-Split Mitered Cornerpost

	51416 Beaded SuperCorner™
	51420 Traditional SuperCorner™
	51447 1-1/4" Traditional SuperCorner™
	51424 Fluted SuperCorner™
	51438 Quarter Round Insert
	51440 5" Corner Cap
	51445 Bay Window Cornerpost

Starter Strips

	53601 2-1/4" Vinyl Starter Strip
	53602 2-1/2" Metal Starter Strip
	53604 5" Metal Starter Strip
	53609 Starter Strip For Insulated Siding
	53605 New Construction Window & Door Starter Strip
	53606 Remodeling Window & Door Starter Strip
	53607 Corner Starter Strip
	53610 4" Shingle Starter Strip

Finish the Job with CertainTeed Accessories

CertainTeed has the most complete siding accessory line in the industry. Virtually every installation challenge imaginable can be addressed with this extensive assortment.

Our accessories are subject to ongoing testing and development to ensure the highest standards of performance available. That's because the items we offer are necessary components of every professional siding installation – and provide the finishing touches that make your exterior design system complete.

Using the proper accessories can make for ease of installation – but that's not all. Because only the proper accessories can guarantee optimum performance, design flexibility and aesthetic enhancement. For detailed installation information, please refer to the CertainTeed Vinyl Siding Installation Guide (CTS205).

Accessory Descriptions

Decorative Trim

Corner Block

55802

Fits at window corners and receives 3-1/2" lineals.

Rosette

55803

Snaps onto corner block for a decorative window treatment.

Crown Molding

55804

Used in conjunction with 5" or 3-1/2" lineals and 3/4" J-channel to create a custom molded window or door header.

Crown Molding Cap

55805

Seals the ends of a crown molding length.

Cornice Molding

55807

Held in place by the Deluxe F-Channel or L-Receiver, this accessory hides the installation of the topmost siding panels. With the help of a nail slot punch, topmost siding panels can be installed with nails every time.

Cornice Molding Cornerpost Cap

55808

Used to cap Cornice Molding over Mitered Cornerposts.

Finish Board

55815

A 3-1/2" top molding piece with a 1-1/4" projection designed for use with CedarBoards Insulated Siding.

Band Board with Foam Insert

55814

A 7-1/4" wide insulated lineal that serves as a transition piece between two different styles of siding or other construction materials. Designed for use with CedarBoards Insulated Siding.

Cornice Receiver

55812

Installed under eaves to hold the Cornice Molding. Also receives Band Board and Finish Board.

2-1/2" Window & Door Casing

55813

A wide face J-channel which accentuates windows and doors. Designed to accommodate new construction window flanges and fit snugly against window and door frames.

Functional Trim

Trim Coil

56901

24"-wide PVC-coated aluminum.

Dual Undersill Trim

56903

Secures trimmed siding panels under windows and eaves regardless of the profile or where in the panel face the panel has been trimmed.

Undersill Trim

56904

Helps secure trimmed siding panels under windows and eaves.

Cedar Impressions Undersill Trim

56912

Secures trimmed Cedar Impressions panels under windows and eaves.

Drip Cap

56907

Acts as a flashing over windows and doors.

Vinyl Fascia

56908

Installed with or without F-channel and undersill trim to provide a maintenance-free fascia board.

Soffit Trim

Soffit Cove Trim

52501

A decorative soffit receiver.

F-Channels

52506 / 52502

Receives soffit panels and helps hold 8" vinyl fascia in place. Available in 3/4" (52506) and 5/8" (52502)

Deluxe F-Channel

52503

Installed under eaves to hold Cornice Molding in place. Also receives soffit panels.

H-Bar

52504 / 52505

Joins soffit panels. Particularly useful on porch ceilings and hip roof applications. Available in 1/2" (52504) and 3/8" (52505) wide receiving panels.

J-Channel

J-Channel

50306 / 50307 / 50305 / 50303 / 50302 / 50301

Universal siding and soffit receiving channel for use around utility openings, under eaves, etc. Available in 3/8" (50306), 7/16" (50307), 1/2" (50305), 3/4" (50303), 1" (50302) and 1-1/4" (50301) widths.

3/4" Flexible J-Channel

50304

Specialized 3/4" siding receiving trim; particularly useful around curved windows and ventilation treatments.

Lineals

3-1/2" Snap-On Lineal

54709

Lineals snap onto 1" face J-Channel; eliminates nailing and rain tabs.

3-1/2" Lineal

54706

For use with a new construction window and door starter around windows and doors as a casing. The 3/4" channel receives siding panels. Can also be used to create a corner system.

5" Lineal

54712

Two lineals create a corner system when installed with a Corner Starter and corner insert. Can also be used with a window starter strip as a window/door casing. The 3/4" channel receives siding panels.

3-1/2" Lineal with Foam Insert

54707

For use with CedarBoards siding and Cedar Impressions D9 shakes, D7 Straight Edge Shakes and Northwoods.

3-1/2" Double Channel Lineal

54713

Exposure matches 3-1/2" window and door surround lineals.

5" Double Channel Lineal

54714

Exposure matches 5" window and door surround lineals.

Corner Systems

Cornerpost

51452 / 51401 / 51402 / 51404 / 51409

Standard corner treatment receives siding panels. Available with 7/16" receiving channel (51452), 3/4" receiving channels (51401 / 51402 / 51404) and 1" receiving channels (51409).

1-1/4" Cornerpost with Foam Insert

51412

For use with CedarBoards siding and Cedar Impressions D9 shakes, D7 Straight Edge Shakes and Northwoods.

Cedar Impression D7 Straight Edge Perfection Inside Cornerpost

51453

For use with D7 Straight Edge Perfection Shingle.

Inside Cornerpost

51436 / 51449 / 51446

Used where siding meets at inside corners; provides a finished look.

Cedar Impressions Mitered Cornerpost

51448 / 51430 / 51432 / 51450 / 51451

Corner treatment for use with Cedar Impressions shingles / shakes. Available in NEW D7" Perfection (51448), T5 Perfection (51430), D7 Staggered Perfection (51451), D7 Rough-Split (51450), D9 Rough-Split (51432).

Beaded SuperCorner™

51416

Wide decorative beaded corner treatment with a foam backing.

Traditional SuperCorner™

51420

Wide decorative traditional corner treatment with foam backing.

1-1/4" Traditional SuperCorner™

51447

Can be used with CedarBoards siding and Cedar Impressions D9 shakes, D7 Straight Edge Shakes and Northwoods..

Fluted SuperCorner™

51424

Fluted corner design with foam backing.

Quarter Round Insert

51438

Installed with a universal corner starter and lineals as a decorative corner treatment.

5" Corner Cap

51440

Decorative Corner Cap that fastens to J-Channel

Bay Window Cornerpost

51445

Adapts to odd angles of bay windows.

Starter Strips

2-1/4" Vinyl Starter Strip

53601

Secures the first course of siding to the home. For use with all CertainFeed sidings except Cedar Impressions, Monogram 46, and CedarBoards.

Metal Starter Strip

53602 (2-1/2") / 53604 (5")

Secures the first course of siding to the home. For use with all sidings except Cedar Impressions and CedarBoards .

Starter Strip for Insulated Siding

53609

Vinyl starter strip for use with CedarBoards siding.

New Construction Window and Door Starter

53605

Butts up against protruding window and door jambs and overhangs for installation of 3-1/2" and 5" lineals. Ideal for new construction applications. Lineals snap in place easily.

Remodeling Window & Door Starter Strip

53606

Holds 3-1/2" and 5" lineals in place around window and door openings. Used in re-siding applications where existing casings have not been removed.

Corner Starter Strip

53607

Secures 3-1/2" and 5" lineals and quarter round insert to create a 4-piece corner.

4" Shingle Starter Strip

53610

For use with Cedar Impressions. Mill finish.

Beadboard
(Reversible)

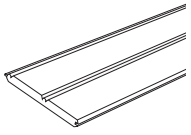

Inside Corner Post



**J-Pocket One-Piece
Corners for Siding**
(Smooth and Woodgrain)

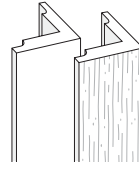

Sill Nose

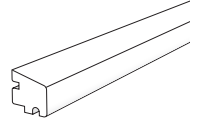

**210
Shingle Mould**

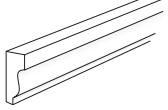

180 Brickmould

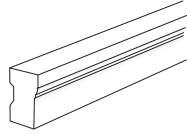

**J-Pocket Trimboards
for Siding**
(Smooth and Woodgrain)

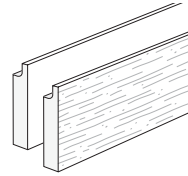

Sill

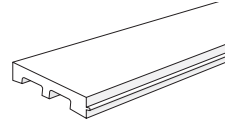

Rake

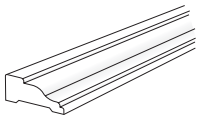

Back Band

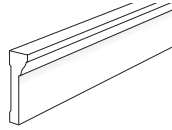

Trimboards
(Smooth/Smooth and
Woodgrain/Smooth)

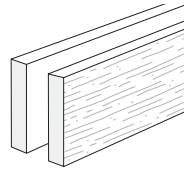

One-Piece Corners
(Smooth and Woodgrain)

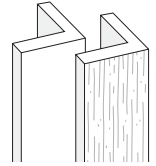

Sheets
(Smooth/Smooth and
Woodgrain/Smooth)

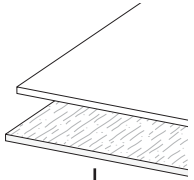

ALSO AVAILABLE FROM RESTORATION MILLWORK™

197 Drip Cap

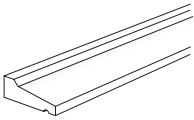

164 Base Cap

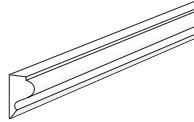

Adjustable Back Band

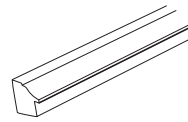

RB3 Casing

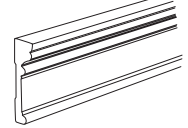

49 Crown

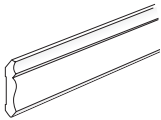

75 Bed Mould

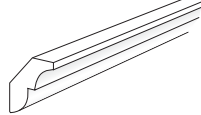

J-Channel Brickmould

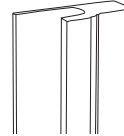

Lattice

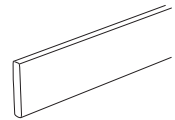

47 Crown

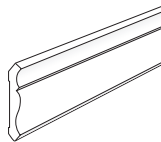

Quarter Round

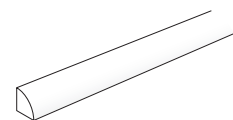

Rams Crown

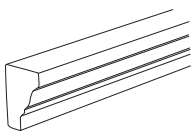

356 Casing

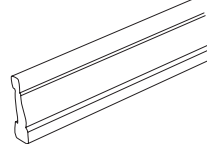

Put the accent on looks that last.

CertainTeed Restoration Millwork™

Restoration Millwork Exterior Trim is engineered to make the creation of charming accents easy—and to help ensure that beautiful looks last.

There's no limit to how Restoration Millwork can be put together to achieve a variety of unique combinations. Our lineup includes trimboards, beadboard, full-size sheets, one-piece corners, brickmould, drip cap and numerous specialty profiles.

Because it cuts, routs and mills easily, and can even be heat-formed, it's just right for custom detailing. Restoration Millwork sheets in particular are perfect for large-size installations, such as gable or bay window detail. It complements virtually all siding materials, including vinyl, fiber cement, wood, stucco and brick.

Whether installed in Natural White or painted* another color, in Smooth or TrueTexture™ finish, Restoration Millwork performs in superior fashion, free from the problems of real wood. Made of cellular PVC, it's a smart way to give almost any non-weight bearing application a distinctive, long-lasting finishing touch.

* See Installation Guidelines (RM003) for painting instructions.

