

**FIRESTONE ROOFING SYSTEMS
INSULATION AND MEMBRANE
MECHANICAL ATTACHMENT GUIDE**

Table of Contents

Introduction	3
1.02 Substrate and Substrate Requirements	3
General	3
Large Wall Opening Enhancement	4
Perimeter and Corner Definition	5
Adjoining Buildings.....	6
1.03 Insulation Attachment.....	7
General	7
Attachment	7
Multiple Layers of Insulation.....	7
Mechanical Attachment of Insulation to Substrate	7
Air Barriers	8
Insulation Mechanical Attachment Patterns	9
Insulation Adhesive Attachment Pattern.....	10
Criteria for Field Testing Insulation Adhesives for Adhesion to Deck Substrates.....	12
1.04 Modified Bitumen Base Sheet Attachment.....	13
Base Sheet Attachment with any Modified Bitumen Cap Sheet	13
Base Sheet Attachment, Coiled Metal Batten, with a SBS Torch Cap	14
Firestone MB 2" Barbed Plates and Firestone Fasteners, with a SBS Torch Cap	14
1.05 Single-Ply Membrane Attachment	15
Acceptable Fastener and Plate Guidelines.....	15
Layouts in Chart Form	19
RubberGard EPDM (Standard, LSFR, or FR), 45 or 60 mil, Batten in the Seam (BITS)	19
RubberGard EPDM (Standard, LSFR, or FR), 45 or 60 mil, Mechanically Attached System (MAS)	20
Rubber Gard EPDM MAX, 45 or 60 mil, Mechanically Attached System (MAS).....	20
UltraPly TPO 96, 45 mil, Mechanically Attached System (MAS).....	21
UltraPly TPO 96, 60/80 mil, Mechanically Attached System (MAS)	21
UltraPly TPO 120, 45 mil, Mechanically Attached System (MAS)	21
UltraPly TPO 120, 60/80 mil, Mechanically Attached System (MAS)	22
UltraPly TPO 148, 45 mil, Mechanically Attached System (MAS)	22
UltraPly TPO 148, 60/80 mil, Mechanically Attached System (MAS)	22
1.06 InvisiWeld Attachment	23
To induction weld the membrane:	23
To heat weld the membrane seams	23
Enhancement Requirements	23
1.07 References.....	24

Introduction

The purpose of this guide is to reinforce installation techniques. The following guide is a supplement to be used in conjunction with the other guides located within the Technical Database. Reference to the specific Design Guide, Application Guide, Detail, Technical Information Sheets (T.I.S), and other Specifications is necessary to ensure that the finished roof system is installed in compliance with Firestone requirements.

NOTE: IF A PROPOSED APPLICATION FALLS OUTSIDE OF THIS SPECIFICATION, CONTACT YOUR TECHNICAL COORDINATOR AT 800-428-4511 FOR ADDITIONAL INFORMATION.

Within Firestone Specifications, reference is made to Firestone's Mechanically Attached Systems.

Mechanically Attached Systems by definition include:

- **Batten in The Seam – BITS**
Batten or plates in the seam of the membrane.
Plates are only allowed with reinforced membranes
- **Mechanically Anchored System (Non-Reinforced Membrane) – MAS**
Lay out sheet battens on membrane, strip in
- **Mechanically Anchored System (Reinforced Membrane) - Reinforced MAS**
Lay out sheet, set plates or battens on membrane, strip in
- **Reinforced Mechanically Attached Strip – RMA**
Lay out strips over insulation; attach strip using plate or battens, place membrane over the strips.

1.02 Substrate and Substrate Requirements

General

1. The Firestone roof system depends on a suitable substrate to perform its intended function of weatherproofing the building.

It is the roofing contractor's responsibility for ensuring that the substrate is acceptable for the Firestone roof system.

2. The substrate to which the Firestone roof system is installed must:
 - Be structurally sound
 - Be dry, smooth, flat and clean
 - Be free of sharp fins, or foreign materials that could damage the membrane
 - Meet the minimum requirements for the system
3. When using asphalt to adhere insulation to a structural concrete substrate, the concrete must be primed with an ASTM D 41 asphalt primer. The primer is applied at a rate of 1-1/2 to 2 gallons per 100 square feet (0.61 to 0.82 L/sq. m).

The Minimum Fastener Pullout Resistances for Specific System

Roofing System	Minimum Fastener Pullout
Fully Adhered Systems with Insulation Mechanically Attached to Deck	300 LBS. (136.1 Kg)
Single-Ply Mechanically Attached and Invisiweld	400 LBS (181.4 Kg)
Base Sheet Mechanically Attached to Deck	300 LBS (136.1 Kg)
Base Sheet Nailed to Deck	40 LBS (18.1 Kg)
Contact your Technical Coordinator at 800-428-4511 if your substrate does not meet these minimum requirements.	

Large Wall Opening Enhancement

The large wall opening enhancement is required when the sum of the various opening areas ($W \times h$) is greater than 10% of the wall area.

Perimeter $\frac{1}{2}$ sheets are required in the hatched area as shown in the diagram below. It is common installation practice to extend the perimeter along this entire building plan dimension to accommodate this rule, but it not necessary.

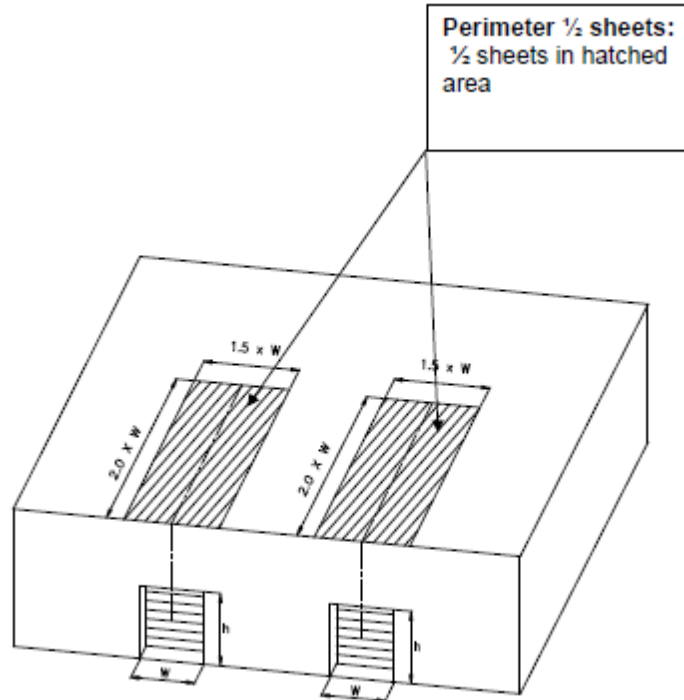

Perimeter and Corner Definition

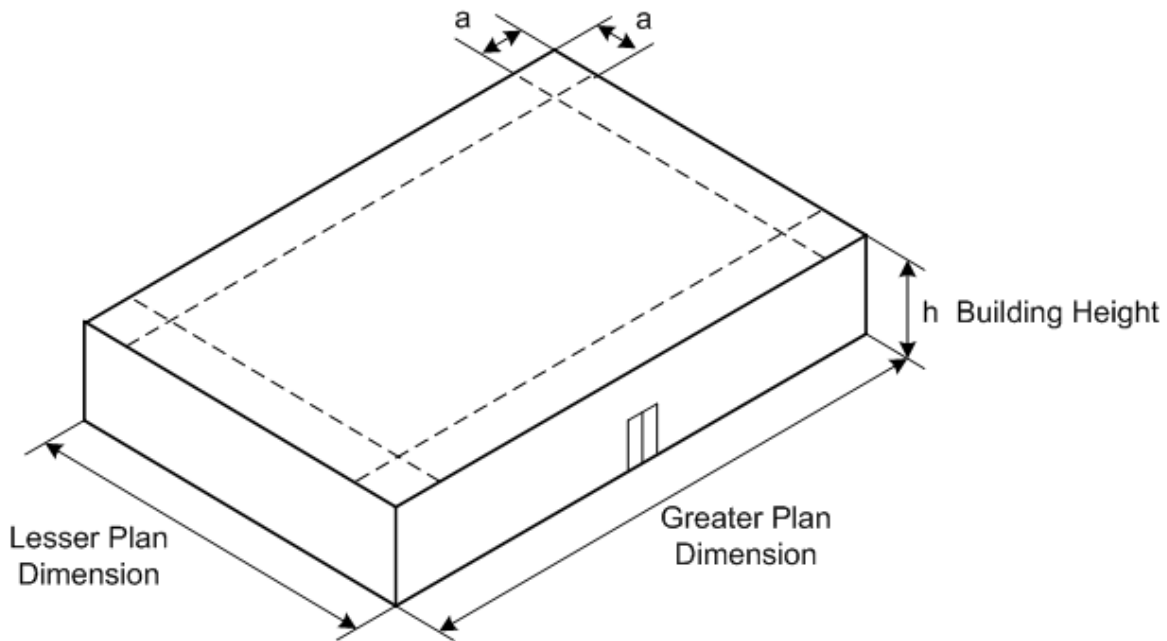

On the diagram above, "a" refers to the width of roof perimeters and a corner for Firestone warranted or FM approved projects are equal to:

For the building height, "h" is less than or equal to 60 feet (18 m)

"a" is the smaller of
0.1 times the building lesser plan dimension
or
0.4 times "h"

And

"a" is never less than 4% of the building lesser plan dimension, but not less than 3 feet (0.9 m).

For h greater than 60 feet (18 m)

"a" is the smaller of
0.1 times the building lesser plan dimension

And

"a" is but not less than 3 feet (0.9 m). An ell is required in corner area equaling "2a".

When the roof slope is less than or equal to 10° (2:12 Slope); "h" is equal to the eave height. When the roof slope is greater than 10° (2:12 Slope): "h" is equal to the mean roof height.

Contact your Technical Coordinator at 800-425-4511 for further clarification on these descriptions.

Adjoining Buildings

When a building adjoins another and has an elevation change of 3' or less then the perimeter and corner enhancements can be omitted in that area. See the first diagram below. In the same building configuration and the elevation change is 3' or greater, the higher building requires a standard building layout (perimeter and corner enhancements) with the lower building omitting the perimeter and corner enhancements in that area. See the second diagram below. If there are concerns in regard to this enhancement, contact your Technical Coordinator at 800-428-4511 for further clarification.

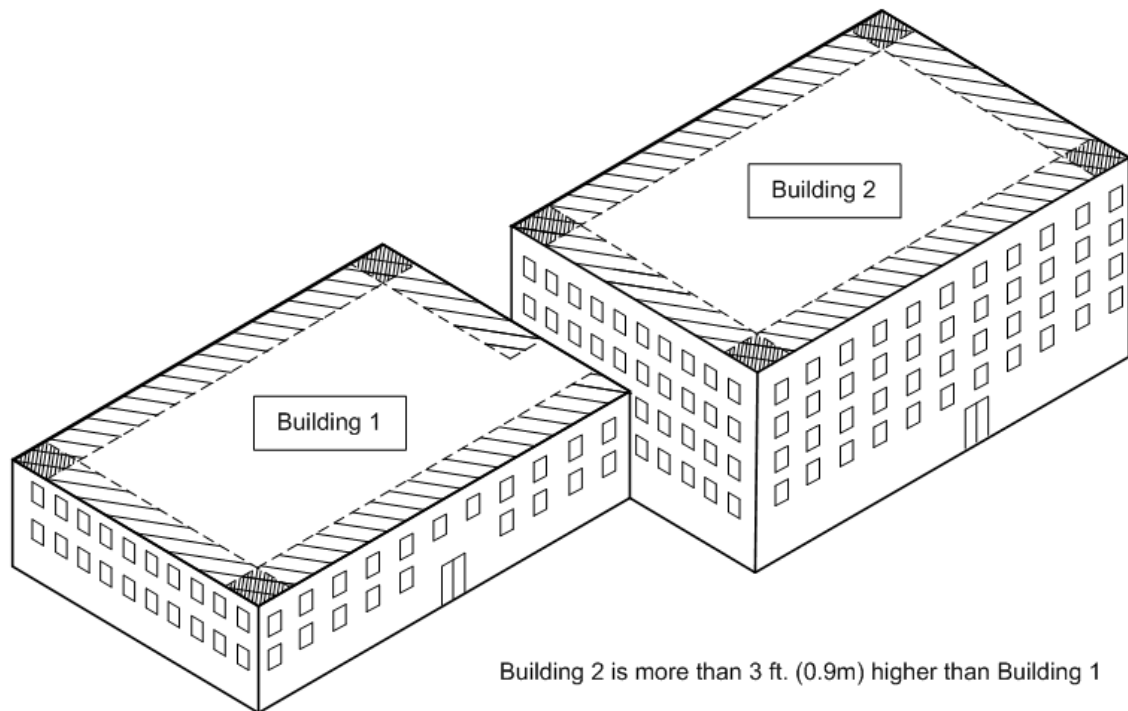
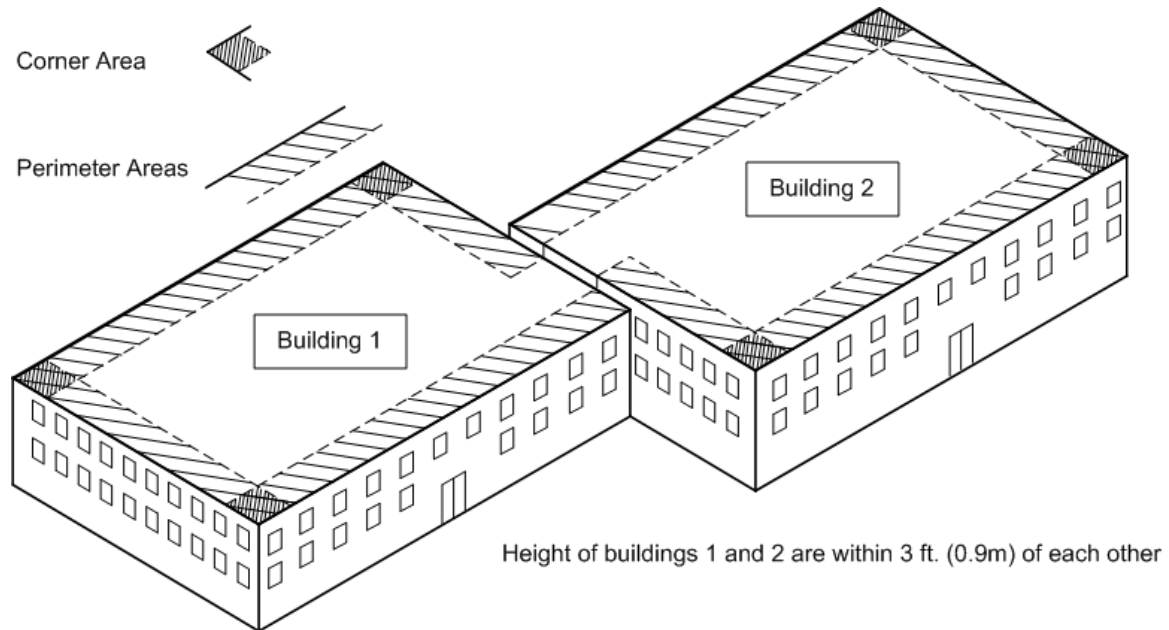

1.03 Insulation Attachment

General

1. Insulation must provide a suitable substrate for the proposed roof system as well as insulation for the building.
2. Insulation thickness requirements may vary for code compliance. Contact the local code or insurance official before contacting your Technical Coordinator at 800-428-4511.
3. Refer to Insulation Technical Information Sheet (TIS) for specific spanning capabilities.

Attachment

1. Insulation may be installed by various methods including fasteners, adhesives and asphalt. It is acceptable to combine fastener and adhesive attachment methods in multi-layer applications.
2. Tapered insulation below the 1.0" (25.4 mm) minimum thickness must be fastened at a rate of one (1) fastener and plate per two (2) square feet (0.22 sq. m). If possible, install the tapered insulation first, covered by the flat stock.
3. Refer to specific Firestone Technical Information Sheets (TIS) for installation and fastening requirements.
4. When a composite of two insulation layers is installed, the fastening pattern required for the top board thickness must be used. A common fastener may be used to install multilayer applications. Some restrictions apply to fastener length depending on standards used.

Multiple Layers of Insulation

1. Where overall insulation thickness is 2 inches (50.8 mm) or greater, Firestone recommends installing the insulation in two (2) or more layers.
2. Insulation may be installed in one or multiple layer applications for the Firestone warranty. If installed in multiple layers, the joints of each succeeding and adjoining layer should be staggered from the joints of previous layers by a minimum of 6 inches (152.4 mm) in each direction. When a composite of two insulation layers is installed, the fastening pattern required is dependant on the top board type and thickness. A common fastener may be used to simultaneously fasten all layers to the structural deck.

Mechanical Attachment of Insulation to Substrate

1. Insulation must be fastened with appropriate Firestone fasteners and insulation plates.
2. Firestone All Purpose (AP's) fasteners are not acceptable, except for wood decks, for any 25, 20 year systems, 15-year re-cover, or Partial Tear off applications.
3. Fastening rates and patterns may vary for code or regulatory compliance. Contact local code or insurance official before contacting your Technical Coordinator at 800-428-4511.

Fastening Patterns for Insulation in Mechanically Attached Single Ply Systems						
Maximum Warranty Term	Top Layer of Insulation		Number of Fasteners per Insulation Board			
	Insulation	Thickness	No Air Barrier		With an Air barrier	
			4' x 4' Insulation Board	4' x 8' Insulation Board	4' x 4' Insulation Board	4' x 8' Insulation Board
Up to 25-Year	ISO 95+ GL or Resista	1.0" - 1.4"	4	5	8	16
		1.5" - 1.9"	4	5	6	12
		2.0" - 4"	4	5	4	8
	Dens Deck	1/4"	4	5	8	16
		1/2"	4	5	6	12
		5/8"	4	5	4	8
	Dens Deck Prime	1/4"	4	5	6	12
		1/2"	4	5	5	10
		5/8"	4	5	4	8
	HailGard	min. 1.5"	4	5	8	16
ISOGard HD	1/2"	4	5	6	12	
Up to 15-Year	FiberTop	1/2" - 1"	4	5	8	16

AIR BARRIERS

1. While some Firestone roof systems may require an air barrier to receive a Firestone warranty, the need for an air barrier, as well as the type, placement and location of the air barrier must be determined by a professional architect or engineer.
2. Air barriers systems are a component of building envelope systems that control the movement of air into and out of buildings.
3. An air barrier may consist of a single material or of two or more materials which, when installed as a system, make up an air impermeable, structurally adequate barrier.
4. Air barrier systems are generally comprised of building components and materials that have an air permeability not exceeding 0.004 cfm/sf under a pressure differential of .3 in. water.
5. No single component or material has the capability to provide a complete air barrier system for a building; therefore, air barrier systems include many components and materials that are interfaced with each other. Firestone recommends that the individual manufacturers of these products provide written certification that their products, when used together, meet this requirement.
6. If the air barrier is to perform its intended role, it must meet a number of requirements:
 - **Continuity:** the assembly must be linked together and sealed at all laps, seams, perimeters and penetrations to ensure that there is no break in the air tightness of the envelope.
 - **Structural Integrity:** The air barrier must be capable of resisting the imposed load or must be supported by one that can. It must be capable of resisting the strongest wind load acting as either a pressure or suction without rupturing or breaking away from its support. The air barrier and its support must be sufficiently rigid to resist displacement.
 - **Air Impermeability:** A major requirement of an air barrier is that it offers a high resistance to airflow.
 - **Durability:** Durability depends largely on how a material reacts to a specific environment such as moisture, temperature, ultra-violet radiation, and to the presence of other materials (incompatibility).

Insulation Mechanical Attachment Patterns

The diagrams below show the required patterns for proper placement of approved fasteners and plates for insulation. These fastening patterns apply to standard 4' x 8' boards. The most common fastener density and patterns are shown. Certain specifications may call for increased densities of fasteners in the perimeter or corner areas. For these patterns and other non-standard fastener densities, contact your Technical Coordinator at 800-428-4511.

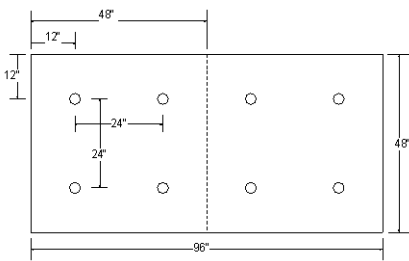

Eight (8)

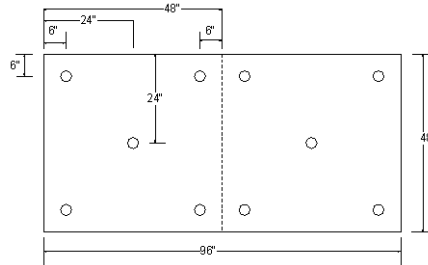

Ten (10)

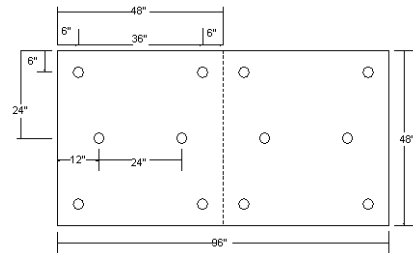

Twelve (12)

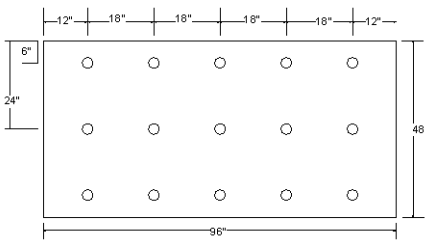

Fifteen (15)

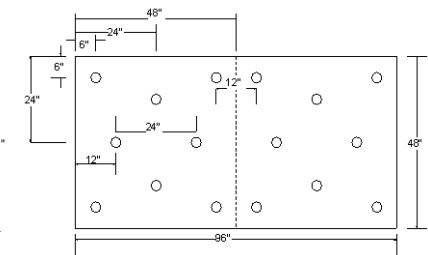

Sixteen (16)

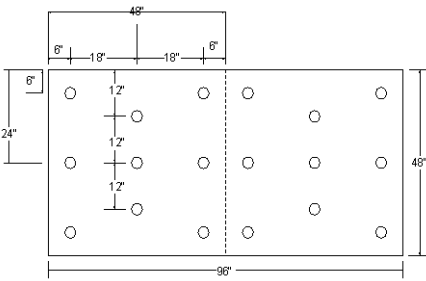

Eighteen (18)

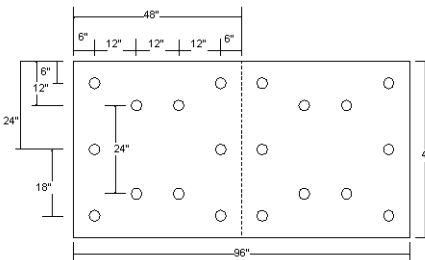

Twenty (20)

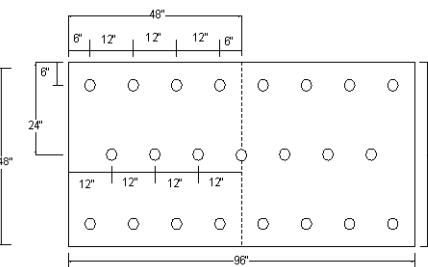

Twenty-Three (23)

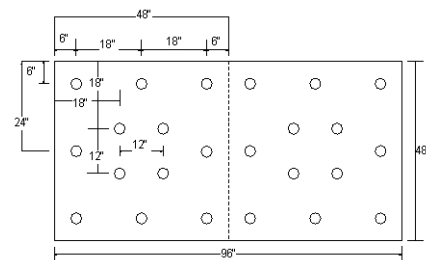

Twenty-Four (24)

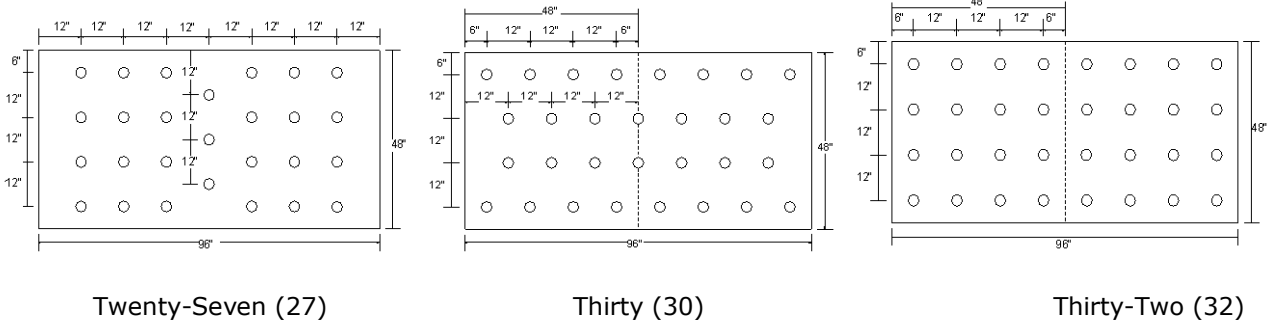

Insulation Adhesive Attachment Pattern

The following Firestone Insulation Adhesives and application methods are acceptable:

Firestone Insulation Adhesive	Application Method
I.S.O. Twin Pack	Bead applied, ribbon pattern
I.S.O. FIX II	Bead applied, serpentine pattern
I.S.O. Stick	Bead applied, serpentine pattern
I.S.O. Spray S	Bead applied, serpentine pattern or Spray applied, full coverage

The maximum size of any insulation board is 4' (1.2mm) x4' (1.2mm) regardless of the thickness.

The rate of application, with a Firestone Insulation Adhesive, is four (4) ribbons per board to be installed in 1/2" to 3/4" beads spaced 12" on center for a standard 55 mph Red Shield warranty. The adhesive application does not increase or decrease with the thickness of the board as in mechanically fastened insulation boards.

Loose or unattached corners in insulation boards shall be repaired by the addition of fasteners and insulation plates as required.

Refer to the Technical Information Sheet for specific information on these products: [Foam Adhesives](#). If enhancements are required or your project presents a unique situation, contact your Technical Coordinator at 800-428-4511.

I.S.O. Twin Pack Insulation Adhesive

- Ensure the use of a 4'x4' board.
- Application surfaces must be even to ensure continuous adhesion.
- Immediately place insulation board into wet adhesive.
- The first and four adhesive ribbon pattern should be inset 6" from the end of the insulation board.
- Immediately place insulation board into wet adhesive and weight with pails of Bonding Adhesive or other available weight.
- See ribbon style diagram on right.

I.S.O. FIX II Insulation Adhesive

- Ensure the use of a 4'x4' board.
- Application surfaces must be even to ensure continuous adhesion.
- Immediately place insulation board into wet adhesive and weight with pails of Bonding Adhesive or other available weight.
- The first and four adhesive ribbon pattern should be inset 6" from the end of the insulation board.
- See serpentine style diagram on right.

I.S.O. Stick Insulation Adhesive

- Ensure the use of a 4'x4' board.
- Requires the PaceCart 2 Dispenser
- Application surfaces must be even to ensure continuous adhesion.
- Place board while adhesive is still wet and tacky. Adhesive should not reach a tack-free state.
- The first and four adhesive ribbon pattern should be inset 6" from the end of the insulation board.
- Immediately place insulation board into wet adhesive and weight with pails of Bonding Adhesive or other available weight.
- See serpentine style diagram on right.

I.S.O. Spray S Insulation Adhesive

- Ensure the use of a 4'x4' board.
- Performance of I.S.O.SPRAY S Adhesive should be periodically monitored during the workday to verify that sufficient rise, adhesion, and full mating is occurring.
- Requires spray rig equipment to apply.
- Application surfaces must be even to ensure continuous adhesion.
- Immediately place insulation board into wet adhesive.
- The first and four adhesive ribbon pattern should be inset 6" from the end of the insulation board.
- Immediately place insulation board into wet adhesive and weight with pails of Bonding Adhesive or other available weight.
- See serpentine style diagram on right.

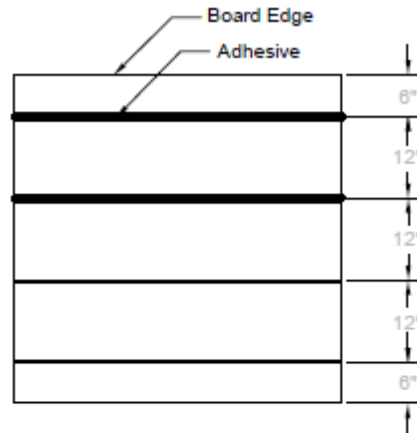

Ribbon Pattern

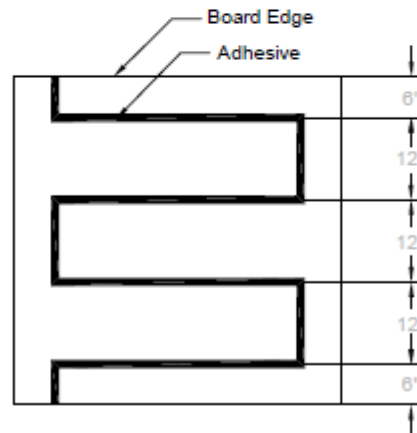

Serpentine Pattern

Criteria for Field Testing Insulation Adhesives for Adhesion to Deck Substrates

1. Prepare an area large enough to allow a 4' x 4' insulation board to be laid in place. Follow the appropriate Firestone Technical Information Sheet guidelines for surface preparation and list of acceptable substrates. Contact your Technical Coordinator at 800-428-4511 if the substrate information is not listed.
2. Apply the adhesive to the deck per recommended application rates and methods (12" o.c., 1/2" to 3/4" bead).
3. Allow the adhesive a minimum of 60 minutes to cure.
4. After the adhesive has been allowed to cure, pull up on the adhered board by placing a hand under the corner or end of the board in the same direction as the ribbons. Make sure that the board is **lifted by hand**. Using tools to scrape the board sometimes disbonds the adhesive from the deck. This will not show whether the adhesive is performing under uplift considerations. (If a tool is used, it should be used to **pry or pop the board up**).
5. Observe the insulation and deck. The desired result is a delamination of the surface or board facer with adhesive and facer residue remaining on the deck or the board breaks apart remaining adhered to the deck at the ribbons. **If the board is lifted and the adhesive pulls/peels off the deck or decking is pulled up with the board, contact your Technical Coordinator at 800-428-4511. This will be considered an unacceptable substrate.**

1.04 Modified Bitumen Base Sheet Attachment

The following information is intended to describe the base sheet attachment within a roofing system for Firestone warranty purposes. This is only one component of the overall roofing system. For more information on the system warranty requirements, please visit the Technical Database at www.firestonebpc.com or contact your Technical Coordinator at 800-428-4511.

Base Sheet Attachment with any Modified Bitumen Cap Sheet

Acceptability	Pattern
Firestone Fasteners and Plates	Install two rows staggered at 18" (457.2 mm) o.c., each approximately 13" (330.2 mm) in from edge of sheet and in side laps at 12" (304.8 mm) o.c.
Any Base Sheet	
Steel, Concrete, Plywood, OSB, Wood Plank, Gypsum or Lightweight Concrete (22 gauge pan)	See diagram on right.

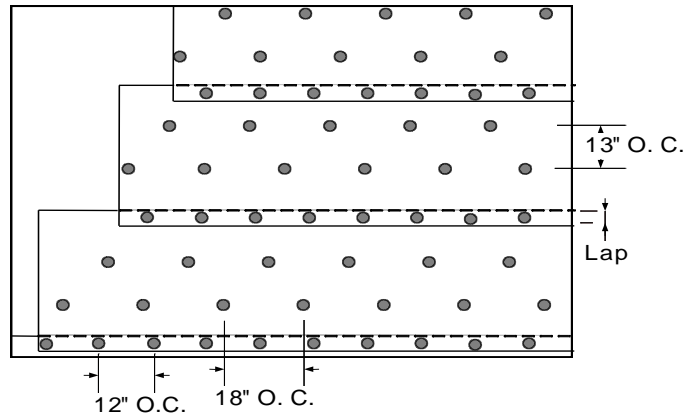

Acceptability	Pattern
Firestone Cap Nails and LWC Base Ply Fasteners	Install two rows staggered at 18" (457.2 mm) o.c., each approximately 12" (304.8 mm) in from edge of sheet and in side laps at 9" (228.6 mm) o.c.
Any Base Sheet	
Plywood, OSB, Wood Plank, Gypsum or Lightweight Concrete	See diagram on right.

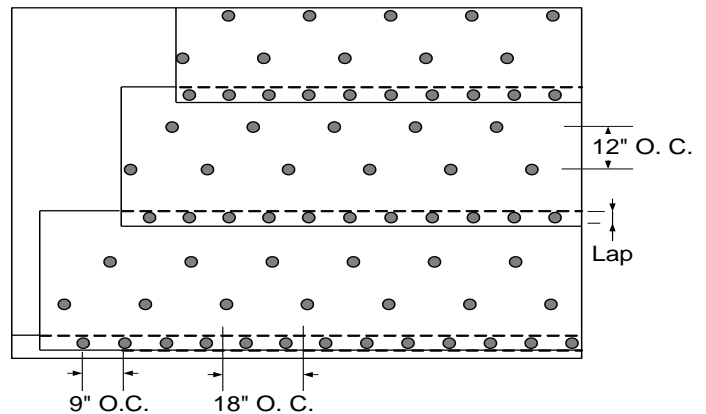

Base Sheet Attachment, Coiled Metal Batten, with a SBS Torch Cap

Acceptability	Pattern
Firestone Coiled Metal Batten and Firestone Fasteners	Install one row with a coiled batten strip at 24" (304.8 mm) o.c. using Heavy Duty fasteners.
SBS Poly Torch Base, or SBS Glass Torch Base	Seams are lapped 4" and heat welded.
Steel only	See diagram on right.

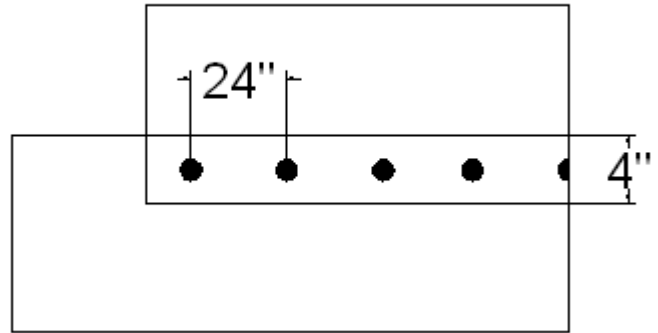

- Base Sheet side laps must be 4" (101.6 mm) and heat welded in this configuration. Then roll with a 20 pound roller.
- Fasteners can be placed at 6", 12" (304.8 mm), 18" (457.2 mm) or 24" (609.6 mm) based on desired warranty.

Base Sheet Attachment, MB 2" Barbed Plates, with a SBS Torch Cap

Acceptability	Pattern
Firestone MB 2" Barbed Plates and Firestone Fasteners	Install one row with a coiled batten strip at 18" (304.8 mm) o.c. using Heavy Duty fasteners.
SBS Poly Torch Base, or SBS Glass Torch Base	Seams are lapped 4" (101.6 mm) and heat welded.
Steel only	See diagram on right.

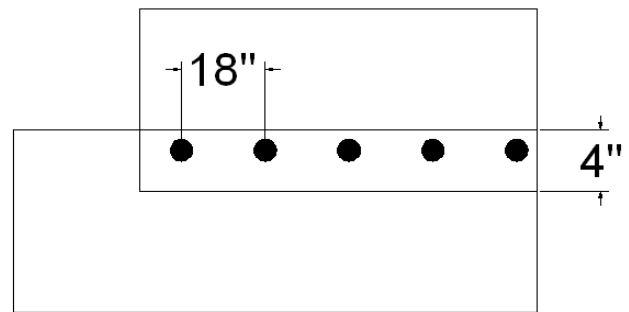

- Base Sheet side laps must be 4" (101.6 mm) and heat welded in this configuration. Then roll with a 20 pound roller.
- Fasteners can be placed at 6", 12" (304.8 mm), 18" (457.2 mm) or 24" (609.6 mm) based on desired warranty.
- Align Plate edge with laying line.

1.05 Single-Ply Membrane Attachment

Acceptable Fastener and Plate Guidelines

Firestone Fastener		For the attachment of:					
		Roofing Insulation (in combination with Firestone Insulation Plate)	Base Sheets (In combination with Firestone Insulation Plate)	Firestone Batten Strips	Firestone Seam Plates	Firestone Termination Bars	Other Firestone accessories
T.I.S. Sheet No.	Fastener	See the specific fastener TIS for specific application data					
1001	All-Purpose Fastener	✓	✓	✓	✓	✓	✓
1002	Heavy-Duty Fastener	✓	✓	✓	✓	✓	✓
1005	Concrete Drive Fastener	✓	✓	✓	✓	✓	✓
		Do not use with polymer batten strips.					
1006	Polymer Fastener	✓	✓	✓	✓		
		(Special battens and plates required)					
1007	Firestone AccuTrac Kit	✓	✓				
		Insulation to steel and wood roof decks with AccuTrac installation equipment. A kit consists of both fasteners and insulation plates for the AccuTrac tool.					
1009	HD Plus Fastener			✓	✓		
		Firestone Metal Batten Strips in Batten in the Seam (B.I.T.S.), M.A.S and Reinforced MAX, mechanically attached systems.					
1011	Purlin Fastener			✓	✓		
		Membrane and QuickSeam R.M.A. Strip to 12 – 18 gauge structural steel purlins. The Firestone Purlin Fastener can be used in conjunction with Firestone 2" Metal Plates, Firestone V-Plates, or batten strips.					
1012	LWC Base Ply Fastener		✓				
		For the attachment of base sheets. Insulation may not be attached with LWC Base Ply Fastener					
1013	#12 Belted Fastener	✓	✓				
		Insulation to steel (18-24 ga.) and wood. Belted fasteners must be installed with the IF160 automatic installation tool available from SFS INTEC. When used for insulation attachment, the Firestone IFC/PH 2.75" x 2/75" (70 mm x 70 mm) plate is used.					
1014	#15 Belted Fastener	✓	✓				
		Insulation and membrane to steel (18-24 ga.) and wood. The #15 Belted fasteners must be installed with the IF160 automatic installation tool available from SFS INTEC. When used for membrane attachment, the Firestone 2 3/8" (60.3 mm) diameter plate is used. When used for insulation, the Firestone 2.75"x 2.75" (70 mm x 70 mm) plate is used.					
1015	Metal Cap Nailing Machine		✓				
		(For the attachment of base sheets. Insulation may not be attached with nails of any kind) Cap nails are to be used to attach a base sheet to a wood deck and cannot be used to attach insulation. Cap nails cannot be used to attach a base sheet through an existing built-up roof when the roof and insulation thickness is over 1/2" (12.7 mm).					
1019	HailGard Fastener	✓					
		For use with Firestone HailGard Insulation and OSB to approved decks. No insulation plate required.					
✓ = Acceptable for use							

T.I.S. Sheet No.	Firestone Plates	For the attachment of:						
		RubberGard EPDM (Standard, LSFR, or FR)		Rubber Gard EPDM MAX		ULTRAPLY TPO		
		Batten in the Seam (BITS)	Mechanically Attached System (MAS)	Batten in the Seam (BITS)	Mechanically Attached System (MAS)	Mechanically Attached System (MAS)	Wide Weld	
1101	2" Metal Plate	✓	✓	✓	✓	✓	✓	For attaching Firestone Reinforced Perimeter Fastening Strips (RPF Strip) to approved substrates as required by Firestone Specifications and Details.
1102	Polymer Fastener Plate	✓	✓	✓	✓	✓	✓	For attaching Firestone Reinforced Perimeter Fastening Strips (RPF Strip) to approved substrates as required by Firestone Specifications and Details.
1103	V-Plate	✓	✓	✓	✓			For attaching Firestone RubberGard MAX membrane, Firestone RPF and QuickSeam RPF Strips, and Firestone QuickSeam R.M.A. Strip to approved substrates as required by Firestone Specifications and Details.
1104	UltraPly 2-3/8" seam Plate					✓	✓	For attaching Firestone UltraPly TPO membranes to approved substrates as required by Firestone Specifications and Details.
1106	Insulation Fastening Plate	✓	✓	✓	✓	✓	✓	For attaching insulation to approved substrates as required by Firestone Specifications and Details.
1107	Polymer Fastener Insulation Plate	✓	✓	✓	✓	✓	✓	For attaching insulation to approved substrates as required by Firestone Specifications and Details.
1108	HD Seam Plate					✓	✓	For attaching Firestone UltraPly TPO membranes to approved substrates as required by Firestone Specifications and Details.
1109	HD Plus Seam Plate					✓	✓	For attaching Firestone UltraPly TPO membranes to approved substrates as required by Firestone Specifications and Details.
1111	UltraPly TPO InvisiWeld Plate					✓	✓	For attaching Firestone UltraPly TPO membranes to approved substrates as required by Firestone Specifications and Details.
✓ = Acceptable for use								

T.I.S. Sheet No.	Firestone Batten and Termination Bars	For the attachment of:					
		RubberGard EPDM (Standard, LSFR, or FR)		Rubber Gard EPDM MAX		ULTRAPLY TPO	
		Batten in the Seam (BITS)	Mechanically Attached System (MAS)	Batten in the Seam (BITS)	Mechanically Attached System (MAS)	Mechanically Attached System (MAS)	Wide Weld
1201	Coiled metal Batten Strip	✓		✓		✓	
		For anchoring membrane and flashing details to approved substrates as required by Firestone Specifications and Details.					
1202	Metal Batten Strip	✓		✓		✓	
		For anchoring membrane and flashing details to approved substrates as required by Firestone Specifications and Details.					
1204	Polymer Fastener Metal Batten Strip	✓		✓			
		For anchoring RubberGard membrane to approved substrates as required by Firestone Specifications and Details.					
1205	Termination bar	✓	✓	✓	✓	✓	✓
		For anchoring and sealing flashing terminations to approved substrates as required by Firestone Specifications and Details.					
1206	Aluminum Drain Bar	✓	✓	✓			
		Used with Firestone Adhered and Ballasted systems for terminating the RubberGard membrane to approved substrates as required by Firestone Specifications and Details.					
1207	Polymer Batten Strip	✓	✓	✓			✓
		Used for anchoring membrane and flashing details to approved substrates as required by Firestone Specifications and Details.					
✓ = Acceptable for use							

"T" Perimeter Single Ply Membrane Attachment

The diagram to the right shows a "T" perimeter attachment for the QuickSeam R.M.A. System with RubberGard EPDM.

It is necessary for the overall strength of the system to reinforce the perimeter and corner areas on a roof which receive an increased uplift pressure causing additional stress on the membrane. The "T" assists in alleviating this change in pressure.

The 12" spacing from the end of the batten strip to the mid-Point of the perpendicular batten strip is critical in this case Due to the change in pressure.

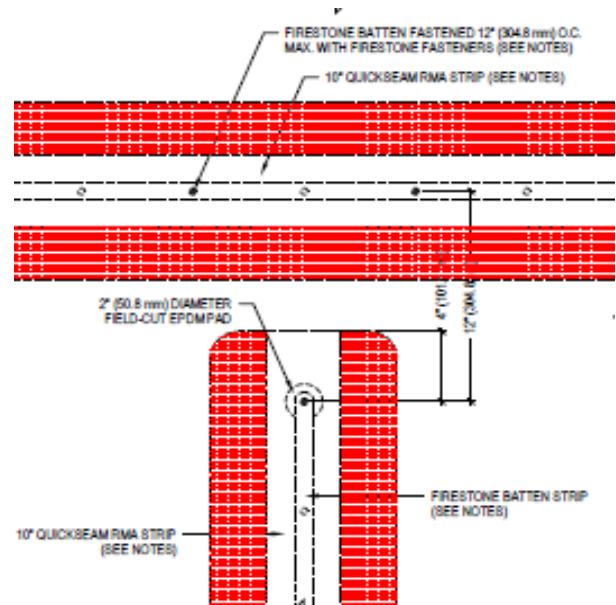

The diagram to the right shows the QuickSeam TPO Flashing at the "T" perimeter. This diagram uses the UltraPly TPO membrane.

As stated in the above scenario, it is necessary for the overall strength of the system to reinforce the perimeter and corner areas on a roof which receive an increased uplift pressure causing additional stress on the membrane. The "T" assists in alleviating this change in pressure.

The 12" spacing from the end of the batten strip to the mid-Point of the perpendicular batten strip is critical in this case Due to the change in pressure.

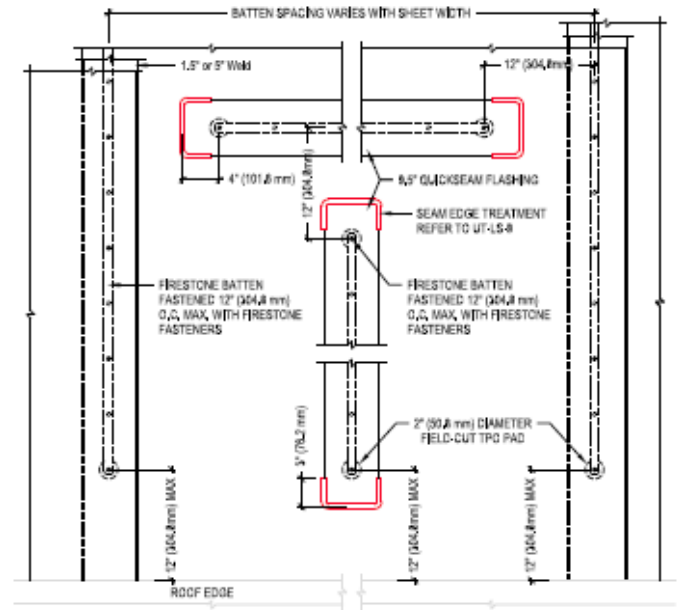

Layouts in Chart Form

Single Ply Mechanically Attached System layouts are also located on the Firestone Technical Database at <http://technicaldatabase.fsbp.com/guides/attachmentguide/>.

In order to determine the correct **Fastening Rate** and **Perimeter Layout**:

- Step 1: Determine the System Type:
 EXAMPLE: The membrane being installed is:
- RubberGard EPDM (Standard, LSFR, or FR)
 - 7½' panels
 - Batten in the Seam system (B.I.T.S.)

- Step 2: Based on the Roof Height, from the table below, determine the:
- Layout Design Number
 - Field Fastening Rate
 - Perimeter Fastening Rate

- EXAMPLE: Roof Height of up to 60':
- Layout Design Number: B-7-2
 - Field Fastening Rate: 12" o.c.
 - Perimeter Fastening Rate: 12" o.c.

RubberGard EPDM (Standard, LSFR, or FR), 45 or 60 mil, Batten in the Seam (BITS)							
Air Barrier Required	Maximum Warranty Term	Seam Attachment		Roof Height	Layout Number	Fastening Rate	
		System Type	Panel Width			Field	Perimeter
No	15-Year	7' BITS	7 ½'	Up to 60'	B-7-2	12" o.c.	12" o.c.
		7' BITS	7 ½'	61' to 120'	B-7-4	12" o.c.	12" o.c.
		8 ½' BITS	9'	Up to 40'	B-9-2	12" o.c.	12" o.c.
		8 ½' BITS	9'	41' to 80'	B-9-4	12" o.c.	12" o.c.
		9 ½' BITS	10'	Up to 20'	B-10-2	12" o.c.	12" o.c.
		9 ½' BITS	10'	21' to 40'	B-10-4	12" o.c.	12" o.c.
Yes	20-Year (60 mil)	7' BITS	7 ½'	Up to 60'	B-7-2	12" o.c.	12" o.c.
		7' BITS	7 ½'	61' to 120'	B-7-4	12" o.c.	12" o.c.
		8 ½' BITS	9'	Up to 40'	B-9-2	12" o.c.	12" o.c.
		8 ½' BITS	9'	41' to 80'	B-9-4	12" o.c.	12" o.c.
		9 ½' BITS	10'	Up to 20'	B-10-2	12" o.c.	12" o.c.
		9 ½' BITS	10'	21' to 40'	B-10-4	12" o.c.	12" o.c.

RubberGard EPDM (Standard, LSRF, or FR), 45 or 60 mil, Mechanically Attached System (MAS)							
Air Barrier Required	Maximum Warranty Term	Seam Attachment		Roof Height	Layout Number	Fastening Rate	
		System Type	Panel Width			Field	Perimeter
No	15-Year	7' M.A.S.	Any	Up to 60'	M-7-2	12" o.c.	12" o.c.
		7' M.A.S.	Any	61' to 120'	M-7-4	12" o.c.	12" o.c.
		8 ½' M.A.S.	Any	Up to 40'	M-9-2	12" o.c.	12" o.c.
		8 ½' M.A.S.	Any	41' to 80'	M-9-4	12" o.c.	12" o.c.
		10' M.A.S.	Any	Up to 20'	M-10-2	12" o.c.	12" o.c.
		10' M.A.S.	Any	21' to 40'	M-10-4	12" o.c.	12" o.c.
Yes	20-Year (60 mil)	7' M.A.S.	Any	Up to 60'	M-7-2	12" o.c.	12" o.c.
		7' M.A.S.	Any	61' to 120'	M-7-4	12" o.c.	12" o.c.
		8 ½' M.A.S.	Any	Up to 40'	M-9-2	12" o.c.	12" o.c.
		8 ½' M.A.S.	Any	41' to 80'	M-9-4	12" o.c.	12" o.c.
		10' M.A.S.	Any	Up to 20'	M-10-2	12" o.c.	12" o.c.
		10' M.A.S.	Any	21' to 40'	M-10-4	12" o.c.	12" o.c.

Rubber Gard EPDM MAX, 45 or 60 mil, Mechanically Attached System (MAS)							
Air Barrier Required	Maximum Warranty Term	Seam Attachment		Roof Height	Layout Number	Fastening Rate	
		System Type	Panel Width			Field	Perimeter
No	20-Year	7' R.M.A.S.	7 ½'	Up to 60'	R-7-2	12" o.c.	12" o.c.
		7' R.M.A.S.	7 ½'	61' to 120'	R-7-4	12" o.c.	12" o.c.
		10' R.M.A.S.	10'	Up to 40'	R-10-2	12" o.c.	12" o.c.
		10' R.M.A.S.	10'	41' to 80'	R-10-4	12" o.c.	12" o.c.
Yes	20-Year	7' R.M.A.S.	7 ½'	Up to 60'	R-7-2	12" o.c.	12" o.c.
		7' R.M.A.S.	7 ½'	61' to 120'	R-7-4	12" o.c.	12" o.c.
		10' R.M.A.S.	10'	Up to 40'	R-10-2	12" o.c.	12" o.c.
		10' R.M.A.S.	10'	41' to 80'	R-10-4	12" o.c.	12" o.c.

UltraPly TPO 96, 45 mil, Mechanically Attached System (MAS)							
Air Barrier Required	Maximum Warranty Term	Seam Attachment		Roof Height	Layout Number	Fastening Rate	
		System Type	Panel Width			Field	Perimeter
No	15-Year	Single Weld	96"	Up to 60'	UT-96-112	12" o.c.	12" o.c.
		Single Weld	96"	61' to 120'	UT-96-212	12" o.c.	12" o.c.
		Wide Weld	96"	Up to 60'	UT-96-112	12" o.c.	12" o.c.
		Wide Weld	96"	61' to 120'	UT-96-212	12" o.c.	12" o.c.
No	20-Year	Single Weld	96"	Up to 60'	UT-96-106	6" o.c.	6" o.c.
		Single Weld	96"	61' to 120'	UT-96-206	6" o.c.	6" o.c.
		Wide Weld	96"	Up to 60'	UT-96-106	6" o.c.	6" o.c.
		Wide Weld	96"	61' to 120'	UT-96-206	6" o.c.	6" o.c.

UltraPly TPO 96, 60/80 mil, Mechanically Attached System (MAS)							
Air Barrier Required	Maximum Warranty Term	Seam Attachment		Roof Height	Layout Number	Fastening Rate	
		System Type	Panel Width			Field	Perimeter
No	20-Year	Single Weld	96"	Up to 60'	UT-96-112	12" o.c.	12" o.c.
		Single Weld	96"	61' to 120'	UT-96-212	12" o.c.	12" o.c.
		Wide Weld	96"	Up to 60'	UT-96-112	12" o.c.	12" o.c.
		Wide Weld	96"	61' to 120'	UT-96-212	12" o.c.	12" o.c.
No	25-Year	Single Weld	96"	Up to 60'	UT-96-106	6" o.c.	6" o.c.
		Single Weld	96"	61' to 120'	UT-96-206	6" o.c.	6" o.c.
		Wide Weld	96"	Up to 60'	UT-96-106	6" o.c.	6" o.c.
		Wide Weld	96"	61' to 120'	UT-96-206	6" o.c.	6" o.c.

UltraPly TPO 120, 45 mil, Mechanically Attached System (MAS)							
Air Barrier Required	Maximum Warranty Term	Seam Attachment		Roof Height	Layout Number	Fastening Rate	
		System Type	Panel Width			Field	Perimeter
No	15-Year	Single Weld	120"	Up to 60'	UT-120-212	12" o.c.	12" o.c.
		Single Weld	120"	61' to 120'	UT-120-412	12" o.c.	12" o.c.
		Wide Weld	120"	Up to 60'	UT-120-212	12" o.c.	12" o.c.
		Wide Weld	120"	61' to 120'	UT-120-412	12" o.c.	12" o.c.
No	20-Year	Single Weld	120"	Up to 60'	UT-120-206	6" o.c.	6" o.c.
		Single Weld	120"	61' to 120'	UT-120-406	6" o.c.	6" o.c.
		Wide Weld	120"	Up to 60'	UT-120-206	6" o.c.	6" o.c.
		Wide Weld	120"	61' to 120'	UT-120-406	6" o.c.	6" o.c.

UltraPly TPO 120, 60/80 mil, Mechanically Attached System (MAS)							
Air Barrier Required	Maximum Warranty Term	Seam Attachment		Roof Height	Layout Number	Fastening Rate	
		System Type	Panel Width			Field	Perimeter
No	20-Year	Single Weld	120"	Up to 60'	UT-120-212	12" o.c.	12" o.c.
		Single Weld	120"	61' to 120'	UT-120-412	12" o.c.	12" o.c.
		Wide Weld	120"	Up to 60'	UT-120-212	12" o.c.	12" o.c.
		Wide Weld	120"	61' to 120'	UT-120-412	12" o.c.	12" o.c.
No	25-Year	Single Weld	120"	Up to 60'	UT-120-206	6" o.c.	6" o.c.
		Single Weld	120"	61' to 120'	UT-120-406	6" o.c.	6" o.c.
		Wide Weld	120"	Up to 60'	UT-120-206	6" o.c.	6" o.c.
		Wide Weld	120"	61' to 120'	UT-120-406	6" o.c.	6" o.c.

UltraPly TPO 148, 45 mil, Mechanically Attached System (MAS)							
Air Barrier Required	Maximum Warranty Term	Seam Attachment		Roof Height	Layout Number	Fastening Rate	
		System Type	Panel Width			Field	Perimeter
No	15-Year	Single Weld	148"	Up to 60'	UT-148-212	12" o.c.	12" o.c.
		Single Weld	148"	61' to 120'	UT-148-412	12" o.c.	12" o.c.
		Wide Weld	148"	Up to 60'	UT-148-212	12" o.c.	12" o.c.
		Wide Weld	148"	61' to 120'	UT-148-412	12" o.c.	12" o.c.
No	20-Year	Single Weld	148"	Up to 60'	UT-148-206	6" o.c.	6" o.c.
		Single Weld	148"	61' to 120'	UT-148-406	6" o.c.	6" o.c.
		Wide Weld	148"	Up to 60'	UT-148-206	6" o.c.	6" o.c.
		Wide Weld	148"	61' to 120'	UT-148-406	6" o.c.	6" o.c.

UltraPly TPO 148, 60/80 mil, Mechanically Attached System (MAS)							
Air Barrier Required	Maximum Warranty Term	Seam Attachment		Roof Height	Layout Number	Fastening Rate	
		System Type	Panel Width			Field	Perimeter
No	20-Year	Single Weld	148"	Up to 60'	UT-148-212	12" o.c.	12" o.c.
		Single Weld	148"	61' to 120'	UT-148-412	12" o.c.	12" o.c.
		Wide Weld	148"	Up to 60'	UT-148-212	12" o.c.	12" o.c.
		Wide Weld	148"	61' to 120'	UT-148-412	12" o.c.	12" o.c.
No	25-Year	Single Weld	148"	Up to 60'	UT-148-206	6" o.c.	6" o.c.
		Single Weld	148"	61' to 120'	UT-148-406	6" o.c.	6" o.c.
		Wide Weld	148"	Up to 60'	UT-148-206	6" o.c.	6" o.c.
		Wide Weld	148"	61' to 120'	UT-148-406	6" o.c.	6" o.c.

1.06 InvisiWeld Attachment

Invisiweld is an induction welded system that requires the use of an induction welder to weld the InvisiWeld Plate to the UltraPly TPO membrane. It also requires the membrane horizontal seams to be heat welded with a standard automatic welder.

To induction weld the membrane:

Activate the weld between the UltraPly TPO membrane and InvisiWeld plate using the electromagnetic induction device as supplied by others. The induction coil, demarked by a red circle on the device, must be positioned over the center of the InvisiWeld plate, ± 1 inch (25 mm). When the induction welding cycle is complete, immediately place a magnetic cooling clamp over the welded UltraPly TPO membrane and plate assembly. This will ensure that there is adequate clamping of the membrane to the plate during cooling, ensuring a good weld. The magnetic cooling clamp device must be left in place for at least 60 seconds while the weld cools and sets.

The magnetic cooling clamp will increase in temperature during continued use. This will cause damage to the membrane. Firestone recommends keeping a pail of cool, clean water near the installation area to dip the magnetic cooling clamp into to reduce its temperature.

Firestone recommends the use of a bathroom plunger to inspect the individual InvisiWeld plate welds. By applying the rubber end of a plunger to the membrane adjacent to the welded InvisiWeld plate and pulling upwards, the condition of the weld can be assessed. This is a good tool to ensure that no InvisiWeld plate welds were missed during roofing.

To heat weld the membrane seams:

Horizontal field splices, these areas are to be welded first. Wherever possible, all field splices on the horizontal surface (including flashing) should be completed using an automatic heat welder that has been designed for hot air welding of thermoplastic membranes. Seams made with the automatic welder shall be a minimum of 1- $\frac{1}{2}$ " (38 mm) wide. Seams made with hand welders shall be a minimum of 2" (50 mm) wide. Use silicone hand rollers to assure proper mating of surfaces as hand welding proceeds. On vertical surface welds, or where an automatic welder is not practical, hand welders shall be used.

Enhancement Requirements

On Metal Building Recover projects, purlin fasteners are used with InvisiWeld Plates. It is important to be aware that the standard enhancements do carry over to the next sheet as shown below. The required perimeter enhancement will be defaulted to in the field area if the perimeter sheet extends into that area. The same is true for the corner enhancements.

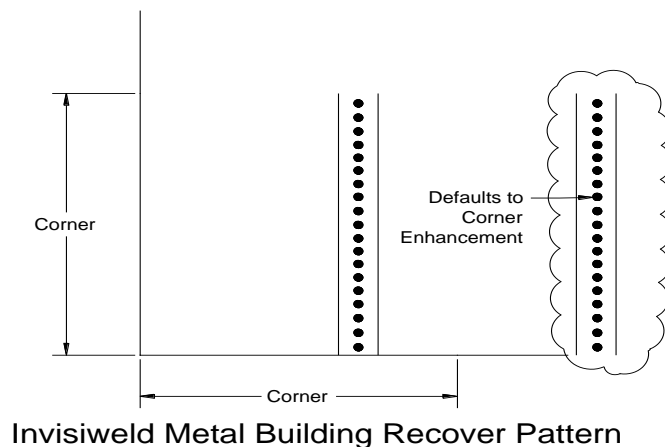

Invisiweld Metal Building Recover Pattern

On standard InvisiWeld projects, All-Purpose or Heavy Duty fasteners and InvisiWeld Plates are used. It is important to be aware that the standard enhancements do carry over to the next sheet as shown below. The required perimeter enhancement will be defaulted to in the field area if the perimeter sheet extends into that area. The same is true for the corner enhancements.

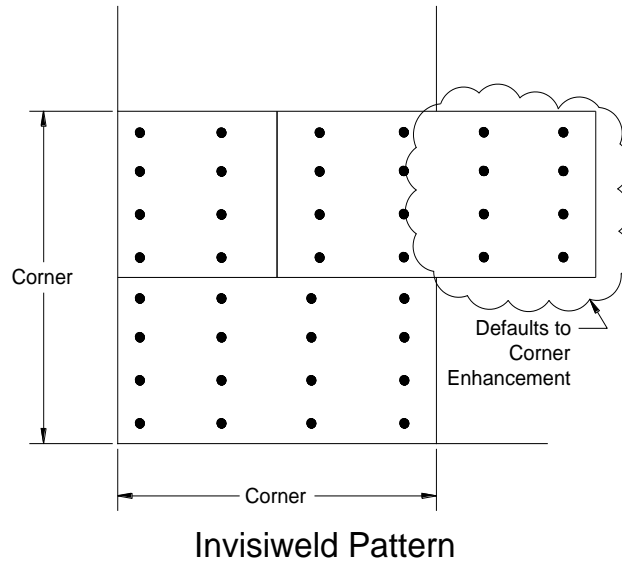

For more information on this system, refer to the Application Guide for InvisiWeld Systems at <http://technicaldatabase.fsbp.com/> or contact your Regional Technical Coordinator at 800-428-4511.

1.07 References

- Firestone Building Products Technical Database <http://technicaldatabase.fsbp.com/>
- Factory Mutual Global Documentation www.roofnav.com