

Liberty™ SBS Self-Adhering Roofing System Application Instructions

Updated: 10/11



*Quality You Can Trust...From
North America's Largest Roofing Manufacturer!™*

www.gaf.com



Liberty™

SBS Self-Adhering Roofing System™

www.gaf.com

How Do I Prepare for a Liberty™ Project?

Before You Start... the installation of your new Liberty™ SBS Self-Adhering Roofing, do the following:

- **Read Instructions Thoroughly...** and understand how the entire system works before starting your installation.
- **Understand The Materials...** know when and where to use each component, why each is necessary, and the common mistakes to avoid.
- **Contact GAF Contractor Services...** at 1-800-ROOF-411 for detailed information on specific applications.

Do's And Don'ts... Liberty™ SBS Self-Adhering Roofing Systems are designed to be installed over low sloped roof decks.

- **Do Install On Roofs Between 1/2" And 6" Per Foot...** and backnail the Liberty™ Cap Sheet when the slope is greater than 1" per foot. Contact GAF Contractor Services at 1-800-ROOF-411 for fastening requirements specific to your project.
- **Do Install In Moderate Temperatures...** between 45°F (7°C) and 95°F (35°C), to assure proper adhesion and easier work conditions.
- **Do Install Over Clean Smooth Surfaces...** that are free of dirt, debris, damage or are otherwise unsuitable for installation.
- **Don't Work Alone...** GAF recommends between 2 and 4 people install Liberty™ SBS Self-Adhering Roofing.

SAFETY FIRST... Protect yourself and others. Consider the following common sense safety precautions, including:

- Wear appropriate clothing, including protective footwear, eye wear and gloves.
- Be aware of your surroundings. Watch for power lines when working near ladders and use common sense on your job site.
- Follow local building codes.
- Bend at the knees. Never lift with your back.

Precautionary Note: The application instructions for this product require the use of primers, adhesives or cements that contain solvents. Apply solvent-based products ONLY as instructed. Excess application of solvent-based products may affect the performance of this product, delay application of the cap sheet, cause surface blistering of the cap sheet or result in the asphalt flowing, dripping or staining. You may notice unpleasant odors from the solvents, which will dissipate when the solvent-based product has dried.

Look for these important safety symbols



What Tools & Equipment Do I Need to Install a Liberty™ Roof?



Trowel



Gloves



Hammer

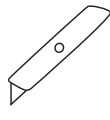

Utility Knife

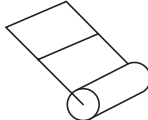

Weighted Roller



Brush



Tape Measure



Caulk Gun



Liberty Installation Kit

Liberty™ Roof Materials... What Do I Need to Install a Quality Roof?

- **Liberty™ Installation Kit...** comes with enough primer and cement to install approximately 200 square feet of membrane. Additional kits or extra primer and cement may be purchased if necessary.
- **Liberty™ Self-Adhering Base/Ply...** is the base weatherproofing layer when applied over acceptable, prepared decks or insulations. Each roll contains approximately 200 square feet.
- **Liberty™ Mechanically Attached Base...** is applied when the deck is unsuitable for self-adhered sheets or when a nailed base sheet is preferred. Each roll contains approximately 200 square feet.
- **Liberty™ Self-Adhered Cap...** is the first line of defense from the weather. Each roll contains approximately 100 square feet.
- **Metal Flashing...** for covering roof perimeter edges. Metal flashings are typically sold in 10 foot sections and must be primed with asphalt primer and allowed to dry before installation.
- **Everything Else...** when measuring, note the size and number of vent pipes, and other flashings. Don't forget any nails, lumber or other additional material that you may need.

Liberty™ Roof Systems... Which roof is right for me?

2-Ply Lay-out (SA Base)

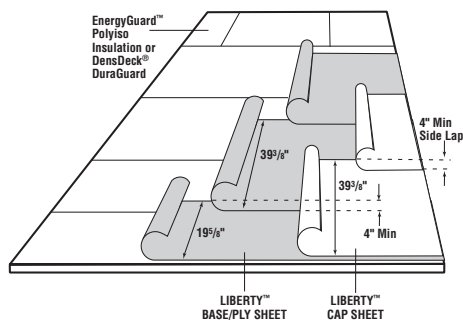

2-Ply Lay-out (MA Base)

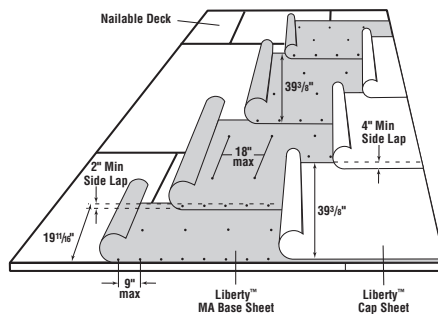

3-Ply Lay-out

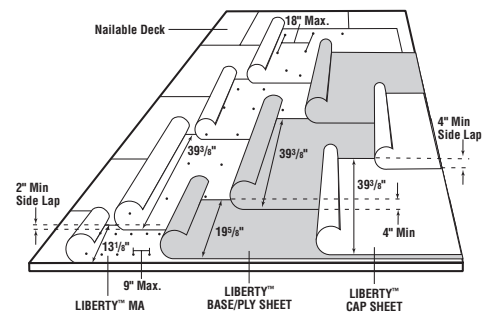

Note: Single-Ply application not shown; visit www.gaf.com for details if required.

STEP 1 - Preparing for a Liberty™ Roof... Is the Surface Ready?



• **Remove All Existing Roofs...** and determine the suitability of the existing roof deck. Alternately, Liberty™ MA base may be installed over certain roof types or deck types not listed. Contact GAF Contractor Services at 1-800-ROOF-411 for more information.



• **Inspect The Deck...** and determine what type of preparation is required. Replace damaged deck materials as necessary.

• **Install Insulation (if desired)...** using GAF DRILL-TEC™ screws and plates or GAF approved adhesives. Use minimum 1/2" thick EnergyGuard™ Polyiso insulation with approved fiberglass or paper facer.

Acceptable Decks

15/32" Minimum Plywood..... Apply light asphalt primer at 1/2 to 3/4 gal per 100 sq. ft.

GAF EnergyGuard™ Polyiso Insulation..... Install Self-Adhered Liberty™ Base Sheet directly to insulation.

Other Deck Types May Be Acceptable..... Contact GAF Contractor Services at 1-800-ROOF-411 for more information.

Common Mistakes (and How to Avoid Them)...



- **Poor Roof Drainage...** can lead to leaks at the seams. Before installation, fix the roof deck at locations where water remains after 48 hours.
- **Not Priming The Deck...** or metal may lead to poor adhesion and is a leading cause of problems.

STEP 2 - Installing Liberty™ Base Sheet... nailed base or adhered base?



1. **Align Base Sheets...** Starting at the lowest point of the roof where there are gutter or fascia edges, extend the base sheet over and down the fascia fully behind the metal edge or gutter height, fastened along roof edge and along fascia 9" o.c. Minimum overhang is 1". Begin with 1/2 width (19 11/16") sheets in 2-ply systems. Use 1/3 width (13 1/8") starter sheets in 3-ply systems and install 2nd ply (interply sheet) starting with 1/2 width (19 11/16") sheets to maintain side lap offsets.



2. **Install MA Base Sheet (Where Required)...** using nails with 1" cap heads. Fasten every 9" in the lap and stagger 2 rows in the field every 18" (Figure 2-1). Cover the entire roof area.

3. **Install SA Base Sheet...** by aligning sheets properly *before* removing the release liners. Roll out sheet and let it sit or "relax" for at least 30 minutes to minimize the potential for wrinkles that can form during installation. Remove one side of the release liner at a time.

4. **Overlap Following Rows of Base Sheet...** horizontally (side lap) by using the line found on the base sheet. Remove release films from top and bottom half of sheet in turn, carefully rolling back into position to maintain overlap. Where no line is present, overlap by 3". Overlap vertically (end laps) by at least 6". Make sure all end laps are at least 18" apart.

5. **Roll Base Sheet Into Place (SA Base Only)...** using a weighted lawn or linoleum roller. This improves adhesion to the deck and ensures properly sealed laps.

NOTE: A base sheet is not required; visit www.gaf.com for more information.

Common Mistakes (and How to Avoid Them)...



- **Not Letting The Liberty™ Sheets Relax...** can lead to wrinkles. In colder weather, the rolls require more time to flatten.
- **Not Rolling The Base Sheets...** Is a leading cause of opening laps. Always pay close attention to laps when rolling the base sheets.

STEP 3 - Installing Liberty™ Cap Sheet... Where Do I Begin?



1. **Install Edge Flashing...** over the base sheet in a 1/8" bed of cement and stagger nail with two rows of roofing nails, 3" o.c. Prime the face on the roof and allow to dry before installing cap sheet.



2. **Align Cap Sheet...** 1/4" from the edge at the lowest point of the roof. Roll out and position full width (39 3/8") sheets with the selvage edge on the high side of the roof. Allow sheet to relax for at least 30 minutes prior to installing.

3. **Overlap Following Rows...** horizontally (Side Lap) by aligning with the bottom of the selvage edge. Vertical (End Laps) must be overlapped by at least 6" and applied in a 1/8" bed of Topcoat® Matrix™ #201 SBS Cement. Make sure all end laps are at least 18" apart and have clipped corners (Figure 3-1). GAF recommends installing a bead of plastic cement along the step up length of the lap.

4. **Remove Release Films...** from top to bottom half of sheet in turn, carefully rolling back into position to maintain overlap. Remove Selvage Edge Release film prior to installing bottom half of sheet and finishing the side lap.

5. **Roll the Cap Sheet Into Place...** using a weighted roller. This improves adhesion to the base sheet and ensures properly sealed laps.

Common Mistakes (and How to Avoid Them)...



- **Not Priming the Edge Metal...** can cause the cap sheet to peel away at the edges. Always prime edge metal before installing cap sheet.
- **Not Applying Cement at the End Laps...** Can cause laps to open. All locations where sheets extend over granules must be set in cement.

STEP 4 - Cleaning Up and Maintaining Your Liberty™ Roof...



• **Remove All Tools and Materials From the Roof...** and make sure there is no debris that can slow or stop the flow of water.

• **Dispose of Materials Properly...** following all federal, state, and local laws.



• **Inspect the Roof Annually...** and remove any leaves, branches, or vegetation that may be present. Look for other damage and repair if necessary.

• **Keep Gutters Clean...** to ensure proper water flow and minimize the possibility of damaging ice dams.

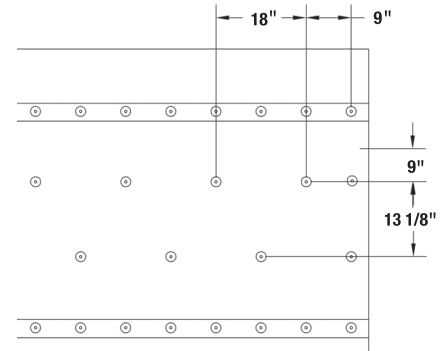

Figure 2-1 (Fastening)

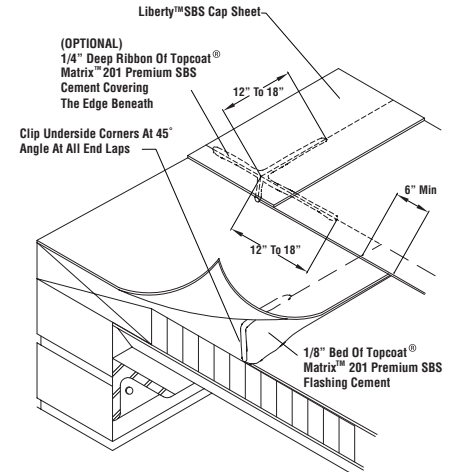
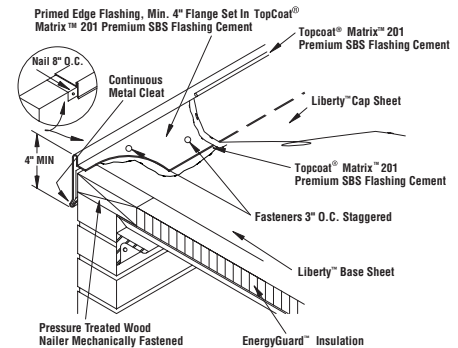
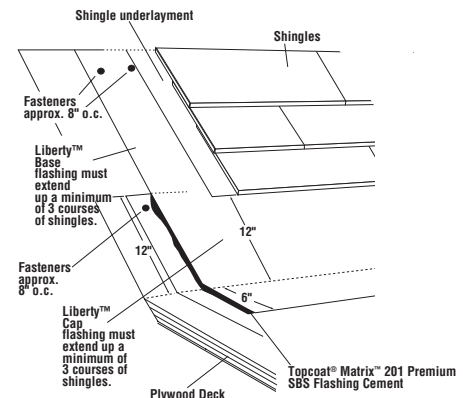

Figure 3-1 (End Lap)



Edge Flashing



Shingle Tie-In