

**SPECIFICATIONS 07541.1 & 07541.2**  
**GENFLEX TPO**  
**MECHANICALLY ATTACHED SYSTEMS**  
**(SINGLE WELD & DUAL WELD SEAMS)**

<b>General</b>	<b>Page</b>
1.01 Description.....	1
1.02 Quality Assurance.....	1
1.03 Submittals.....	1-2
1.04 Product Delivery, Storage, and Handling.....	2
1.05 Job Conditions (Cautions and Warnings).....	3-4
1.06 Warranty.....	4-6
1.07 Codes.....	6
1.08 Acceptable Structural Roof Decks.....	7
1.09 Acceptable Roof System Substrates.....	7-9
1.10 Acceptable GenFlex Fasteners.....	9-10
1.11 Wood Nailers.....	10-11
<b>Products</b>	
2.01 General.....	11
2.02 Membrane.....	11
2.03 Related Materials.....	11-12
<b>Installation</b>	
3.01 Substrate Criteria.....	12
3.02 Substrate Preparation.....	12
3.03 Insulation Application.....	12-13
3.04 Insulation Securement.....	13
3.05 Membrane Application.....	13
3.06 Membrane Attachment and Seaming Procedures.....	13-14
3.07 Perimeter and Base Membrane Attachment.....	15
3.08 Flashings.....	15-18
3.09 Walkways.....	18
3.10 Finished Roof Protection.....	18
System Specific Supplemental Details.....	19-24



**SPECIFICATIONS 07541.1 & 07541.2**  
**GENFLEX TPO**  
**MECHANICALLY ATTACHED SYSTEMS**  
**(SINGLE WELD & DUAL WELD SEAMS)**

**PART 1 — GENERAL**

**1.01 DESCRIPTION**

- A. **GenFlex Roofing Systems recommends the use of a design professional to assure correct roof design for the roofing project, to address any non-standard conditions on the project, and to ensure compliance with applicable building codes.**
- B. GenFlex specifications are designed to detail the minimum requirements to obtain a GenFlex warranty on a roofing project. Your roofing project may have additional requirements spelled out in the contract documents above and beyond the GenFlex requirements due to applicable building codes or design characteristics specified by the project designer.
- C. The GenFlex Roofing Systems TPO Mechanically Attached System (inner-seam securement configuration) utilizes GenFlex TPO, TPO Plus, or Fleece Backed TPO Membrane applied over a GenFlex approved insulation or structural substrate and anchored to the structural deck in accordance with GenFlex TPO Mechanically Attached System design requirements.
- D. One GenFlex Roofing Systems Licensed Contractor shall perform roof application and related work. A single firm is required so that there is undivided responsibility for the performance of the completed roofing system.
- E. Furnish and install the GenFlex Mechanically Attached Roofing System in strict accordance with drawings and specifications approved by GenFlex Roofing Systems.
- F. Related Work  
The work includes, but is not necessarily limited to, the installation of:
- |                                     |  |
|-------------------------------------|--|
| 1. Vapor Retarders (where required) | 9. Wood Nailer   |
| 2. GenFlex Insulation               | 10. GenFlex Walkway Pads   |
| 3. GenFast Bar Anchors              | 11. GenFlex Approved Sealants  |
| 4. GenFlex Separator Mat            | 12. GenFlex Adhesives  |
| 5. GenFast Fasteners                | 13. GenFlex Metal Edging and Coping per ANSI / SPRI ES-1 (as required)   |
| 6. GenFlex Roof Membrane            | 14. All metalwork to be fastened per Sheet Metal & Air Conditioning Contractors National Association (SMACNA) standards. |
| 7. GenFlex Flashing                 |  |
| 8. GenFlex Metal Flashing           |  |

**1.02 QUALITY ASSURANCE**

- A. The roofing system must be installed by a GenFlex Roofing Systems Licensed Contractor for the project to be eligible to receive a manufacturer's system warranty.
- B. There shall be no deviation made from this specification or the detail drawings without written approval from GenFlex Roofing Systems fourteen (14) days prior to the start of the roofing project.
- C. All completed work must be reviewed by the GenFlex Licensed Contractor for proper installation **prior** to requesting a final inspection.
- D. Upon request for final inspection from the GenFlex Licensed Contractor, an inspection shall be conducted by a Technical Representative of GenFlex Roofing Systems to ascertain that the roofing system has been installed according to GenFlex Roofing Systems current published specifications and details. This inspection is not intended to be a final inspection for the benefit of the owner. It is for the benefit of GenFlex Roofing Systems to determine whether a warranty can be issued.
- E. It is the roofing contractor's responsibility to adhere to all applicable local and national building codes for roofing system installation requirements and limitations in his/her geographical area.
- F. For specific code and testing agency approvals achieved by GenFlex Roofing Systems, refer to the agency's published listings or call the GenFlex Roofing Systems Technical Department.

**1.03 SUBMITTALS**

- A. When a material and workmanship or full system warranty is sought, submit a Pre-Job Survey Form to the GenFlex Roofing Systems Technical Department for approval **prior** to the job start. This enables the Technical Department to approve the intended assembly and assign a job number to the project. This

submittal may include deviation request forms, moisture scans, or pullout test results, depending on the project criteria.

1. The Pre-Job Survey **must** be filled out completely and accurately to include any prior deviations approved from this specification.
  2. The Pre-Job Survey must have a roof drawing or shop drawing attached for the project to be assigned a job number. The roof drawing must show: a) the dimensions of the roof system being submitted for warranty coverage, b) the location of all curbs installed during initial application, c) the type and thickness of insulation used in each area, d) the penetration count by either plotting or listing the penetrations installed during the initial application broken down into the various categories, e.g. pipes, drains, pourable sealer pockets, etc. This information is required in order to protect both GenFlex Roofing Systems and the installing contractor from additional liability for alterations made to the roof system without GenFlex's knowledge or involvement. The Technical Department requests a separate roof drawing for each roof assembly type installed on a project. For example, a project consisting of an adhered and a ballasted system would require two separate roof plans. If the two different assemblies are on the same building, please indicate their proximity to each other on the roof plans for reference purposes.
- B. When material and workmanship or full systems warranties are desired, GenFlex Roofing Systems **must** receive the Pre-Job Survey or be contacted **prior** to project installation. Additional information may be required for the wind design of the system.
  - C. Upon completion of the project and **prior** to requesting a final inspection, the roofing contractor shall review all completed work to verify proper installation. The roofing contractor shall then notify GenFlex Roofing Systems of the date of completion, and request a final inspection.
  - D. Upon completion of the roof inspection by a technical representative of GenFlex, satisfactory completion of any punch list items, and notification to the GenFlex Technical Department that punch list items are complete, the warranty may be issued to the installing contractor.
  - E. GenFlex offers ten year membrane limited warranties for projects on which GenFlex brand membrane is installed in accordance with GenFlex Technical Specifications and construction details and maintained in accordance with the requirements listed on the warranty. These material only warranties are available at [www.genflex.com](http://www.genflex.com). Material only warranties that exceed ten years in duration may only be obtained by GenFlex Licensed Contractors via the Pre-Job Survey submittal process.
  - F. GenFlex also offers a labor and material limited warranty. This warranty is available to GenFlex Registered or Licensed Contractors. To view a sample of this warranty, please visit [www.genflex.com](http://www.genflex.com). This warranty may be obtained by submitting a Registered Applicator Project Notification form to the GenFlex Technical Department and remitting applicable warranty fees.

#### 1.04 PRODUCT DELIVERY, STORAGE AND HANDLING

- A. Deliver materials in original, unopened containers.
- B. Containers shall be labeled with manufacturer's product name and general information.
- C. All materials, excluding the membrane, should be stored between 60 °F (16 °C) and 80 °F (27 °C). If materials are exposed to lower temperatures, restore material to 60 °F (16 °C) minimum temperature before using.
- D. Store all materials, including membrane, in a dry, protected area. Damaged materials must not be used. Installed materials found to be damaged shall be replaced at contractor's expense.
- E. Protect the membrane from abuse or damage during storage.
- F. Protect all stored materials from inclement weather by covering with properly secured breathable tarpaulins until ready to install.
- G. Improperly stored insulation that has been allowed to get wet shall not be used in a warranted roof system and shall be replaced at the contractor's expense. In cases where the wet insulation is isolated to only a few boards per bundle, only those boards that have been wet must be replaced. Failure to replace insulation boards that have been exposed to moisture can result in bowing or curling of the insulation because the material may dry unevenly while in the roof system. This may adversely affect the dimensional stability of the insulation material. In either case, the removal and replacement of the affected insulation shall be the responsibility of the installing contractor as a punch list item or under their two-year obligation if discovered after the initial inspection but within twenty-four (24) months beginning with the date GenFlex's limited warranty is issued to the building owner.
- H. Keep insulation tarped and protected from moisture until ready for installation. GenFlex Polyiso is wrapped with Tuff Wrap to ensure the integrity of the product during shipping and at work sites. Tarping is not required unless the wrap is damaged or opened. In that case, the Polyiso bundle(s) should be tarped. **Do not install more insulation than can be roofed over in the same workday.**

## 1.05 JOB CONDITIONS (CAUTIONS AND WARNINGS)

**Note:** Prior to the use of any GenFlex Roofing Systems product, consult Material Safety Data Sheets for applicable cautions and warnings.

- A. Do not use oil or bituminous base roof cement with GenFlex materials.
- B. Do not install GenFlex membrane directly in contact with new or resaturated asphalt.
- C. Do not expose membrane or accessories to temperatures of 180 °F (82 °C) or above.
- D. Do not allow waste products, such as petroleum grease, oil, or solvents, or direct steam venting to come in contact with the GenFlex roofing system. Any exposures not typical for normal roofing installation must be presented to GenFlex Roofing Systems for assessment of any impact on the performance of the roofing system.
- E. Do not install GenFlex membrane directly in contact with coal tar roof surfaces.
- F. When using an insulation / underlayment attachment method other than mechanical securement with GenFlex fasteners of an approved type, size and length, there may be additional factors to take into consideration. The primary issues to consider include:
  1. The products involved and the performance of asphalt attachment or insulation adhesive by others will not be included in the GenFlex system warranty coverage because they are products supplied by others. Separate warranty coverage may be available from the manufacturer of the product being used, but it is separate from the GenFlex warranty coverage and may be pursued by the installing contractor or property owner.
  2. For insulation / underlayment attachment methods other than loose laid for ballasted systems and mechanically anchored to GenFlex specification for adhered and mechanically attached systems, the maximum allowed board size is 4' x 4' (1.2 m x 1.2 m).
  3. When using insulation adhesive, verify that the approved substrate has not been altered by coatings, sealants, or additives. **Note:** Unless the GenFlex Technical Department provides written approval of specific products and / or applications prior to the start of a roofing project, alteration of the bonding substrate (e.g. application of primers and / or sealants, etc.) voids warranty coverage for the insulation attachment.
- G. Do not tear off more roof than can be covered the same workday.
- H. Do not install more roofing insulation than can be roofed over and sealed the same workday.
- I. Do not phase roofing installation. Complete all details daily, and install night seals as required to ensure the installed roofing components are protected from moisture.
- J. Perform daily quality control checks of installed seams and details, and correct any identified deficiencies each and every workday to prevent moisture from entering the roof system.
- K. Cold weather application of GenFlex adhesives and sealants requires special consideration. As specified in the Product Delivery, Storage and Handling section above, the GenFlex roofing adhesives, solvents, caulks and sealants must be stored at service temperatures ranging from 60 °F (16 °C) to 80 °F (27 °C) for 24 hours prior to use. Please note that the GenFlex water based bonding adhesives should never be stored in temperatures below 32 °F (0 °C) or allowed to freeze. Water based adhesives that have frozen should not be used and must be disposed of in a proper manner.
  1. If a room temperature storage environment is not available, the GenFlex products must be restored to serviceable temperatures before application by alternate means, such as hot boxes or pail warmers, and rotated as required to maintain a serviceable installation temperature throughout the application process.
  2. During periods of high humidity, especially at cooler temperatures, condensation may form on the surface of the adhesives and primer. This is referred to as “blushing.” It occurs when the dew point is near the ambient outside temperature and is caused by the evaporation cooling process inherent in the flashing of solvents. Blushing is more prevalent on foggy or overcast days. When condensation is present, the application should be discontinued, since proper adhesion between mating surfaces cannot be achieved once the prepared surface is contaminated with moisture. If the applied product is contaminated with moisture, wait until conditions improve, and then allow the adhesive to dry completely prior to the application of an additional fresh coat of adhesive or primer when conditions no longer cause condensation on the surface of the adhesive or primer. During cold weather, work in smaller areas, allow longer flash-off times, and limit application of solvent-based adhesives and sealants to the warmest hours of the work period possible.
  3. Solvent-based adhesives tend to surface-flash during cold weather, forming an outer skin on the surface before the entire adhesive layer has had sufficient time to flash-off. To correct the application condition when this occurs, allow the adhesive layer to flash-off properly. To determine if the applied adhesive

has surface-flashed, conduct a “push” test of the prepared surface by touching the adhesive film with your finger (away from any seam edges), and push to see if your finger slides through any un-flashed adhesive. If a surface skin condition is identified, allow extra time for the adhesive film to properly flash-off before retesting. In extreme cases of surface-flashing, it may be necessary to allow the adhesive film to flash-off completely overnight and to start over when better working conditions exist. Adhering two surfaces that have suffered surface-flashing of the adhesive will result in blisters and bubbles in the membrane application, caused by the trapped solvent from the uncured adhesive.

4. **Under no circumstances should laying of membrane, or application of adhesives, primers, or caulks take place during periods of any form of precipitation.**
  5. Application temperatures for water based adhesives should meet the minimums required for the product. Please refer to current GenFlex Technical Specifications or individual Product Data Sheets for temperature restrictions.
- L. Cold weather application of GenFlex TPO large sheet membranes requires special consideration.
1. Thermoplastic membrane roofs are assembled with hot air welded seams, using electric powered hot air welders. Cold weather applications utilizing welded seams require extra attention to ambient conditions because fluctuations in temperature and wind can adversely affect the welding parameters established at the beginning of the workday.
  2. When welding sheets together during a cold weather application, it is important to reestablish welding parameters after every break in hot air welding, by conducting a welding test on some scrap membrane in order to set the welding equipment up correctly for the current conditions.
  3. In cold weather conditions, it is recommended that the welding equipment be set up with slightly higher temperatures and slower speeds. As before, it is recommended that practice welds or seam samples be created in order to verify seam quality. Should “cold welds” be the result, try lowering the speed of the machine while keeping the temperature constant. Adjusting the speed should increase the heat in the seam area, thus increasing the weld quality. If this condition does not result in a proper weld, try lowering the speed once again. It is recommended that either the speed or temperature remain constant as you attempt to find the correct settings for rooftop conditions. If you continue to experience difficulty in achieving quality welds, please call your GenFlex Technical Representative, and he or she will be able to walk you through the adjustment process.

## 1.06 WARRANTY

GenFlex Roofing Systems offers several levels of warranty coverage on roofing systems installed using GenFlex brand products. Available coverage ranges from membrane only warranties to full system material and labor warranties. Full system warranties include coverage for **all** GenFlex brand materials used in a new roof assembly and the workmanship used to install the GenFlex products.

GenFlex offers ten year membrane limited warranties for projects on which GenFlex brand membrane is installed in accordance with GenFlex Technical Specifications and construction details and maintained in accordance with the requirements listed on the warranty. These material only warranties are available at [www.genflex.com](http://www.genflex.com). Material only warranties that exceed ten years in duration may only be obtained by GenFlex Licensed Contractors.

GenFlex also offers a labor and material limited warranty. This warranty is available to GenFlex Registered or Licensed Contractors. To view a sample of this warranty, please visit [www.genflex.com](http://www.genflex.com).

When a material and workmanship warranty is sought, the level of warranty coverage is indicated by the installing GenFlex Licensed Contractor on the Pre-Job Survey form submitted during the project registration process. The project registration information submitted by the contractor is then validated against the requirements for the type and length of warranty sought during the project review process before a job number is issued on a project. Listed below are some of those requirements for consideration. Additional system specific and warranty specific requirements apply and are subject to change at any time through the technical update bulletin notification process. Review the latest technical updates and our Warranty Requirement Reference Guide at [www.genflex.com](http://www.genflex.com) for the most current information.

Because each warranty type and term carries specific requirements, requests from the installing contractor and / or property owner to change the warranty type or term after installation may or may not be honored, depending on the actual installed roofing assembly and components.

- A. A project is eligible for warranty coverage by GenFlex Roofing Systems, including workmanship for those materials supplied by GenFlex Roofing Systems, when the project is completed according to the most current GenFlex specification by a GenFlex Roofing Systems Licensed Contractor.
- B. When a full system warranty or a warranty that exceeds ten years of coverage is specified for a project, a complete tear-off to the structural deck is required. On a deviation basis, subject to GenFlex review and acceptance, an independent moisture survey may be submitted instead of a tear-off. For a moisture survey to be considered, the survey must have documented core cuts with findings fully specified. All wet insulation identified during the core cut process must be removed prior to reroofing and replaced with an acceptable new material. GenFlex's acceptance of the moisture survey does not indicate the insulation is suitable for recover, and GenFlex does not accept any liability for the performance of the existing insulation. Any existing insulation left in place and recovered is expressly excluded from warranty coverage and remains the responsibility of the building owner.
- C. Upon approved inspection of the completed installation by a GenFlex Roofing Systems Technical Representative and satisfactory completion of any punch list items, a warranty may be issued to the installing contractor.
- D. The workmanship warranty is available for roofing systems installed on commercial, industrial, or institutional buildings only and is not available for single family residences, walking decks, terraces, patios or areas subjected to conditions not typically found on roofing systems. Please visit [www.genflex.com](http://www.genflex.com) to learn more about membrane limited warranties available for single family residences.
- E. The warranty period is expressed on the warranty certificate, which reflects the inclusive dates of coverage.
- F. GenFlex insulation and insulation adhesive or insulation plates and fasteners are required on all full system warranted projects and on projects with warranty terms greater than ten years.
- G. If the metalwork on a project is specified by the designer to be included in a full system warranty, use GenFlex brand edge metal and coping products. Contact your GenFlex Territory Sales Manager or Representative for information.
- H. If a metal flashing product by others is submitted via a deviation request for inclusion in the warranty coverage, the following are minimum requirements for consideration:
  - 1. The metalwork must be shop or factory formed or extruded.
  - 2. The metalwork must be configured and installed in accordance with SMACNA guidelines and NRCA installation instructions.
  - 3. Minimum requirements regarding metalwork material are, 24 ga (0.61 mm) G-90 Kynar pre-finished steel or 0.040" (1.02 mm) aluminum (mill finished, pre-finished or anodized).
  - 4. A deviation request for metalwork inclusion in warranty coverage must accompany the Pre-Job Survey Form submitted by the installing contractor.
  - 5. The deviation request must include shop drawings of the metalwork to be included and a roof plan showing the installed location and linear dimension for each profile.
  - 6. Should the deviation request be granted, the installing contractor will be responsible to GenFlex Roofing Systems for materials and installation labor performance for a period of two (2) years from the date of the approved final inspection by GenFlex under their installer's agreement.

**Note:** The approval of metalwork for inclusion in warranty coverage is conditional upon acceptance by GenFlex Roofing Systems, and, if approved, is subject to the "terms, conditions and limitations" of the requested warranty. Under no circumstance will any warranty coverage for metalwork exceed the wind speed limitation of the warranty issued for the roofing system. Aesthetic appearance is expressly excluded from warranty coverage. Metalwork by others is **not** permitted on projects warranted for wind speeds of 90 mph (144.8 km/h) or higher.
- I. Contact GenFlex Roofing Systems for additional warranty information.
- J. When it is anticipated that GenFlex membranes will be exposed to animal fats, petroleum grease or other grease products, the owner or owner's representative is responsible for specifying that a sacrificial sheet, sand trap, or grease trap type containment product must be used to protect the waterproofing roof membrane.
- K. It shall be the owner's responsibility to expose the membrane in the event that warranty service is required when access is impaired. Such impairment could include, but is not limited to:
  - 1. Design features, such as window washer systems, which require the installation of traffic surface units in excess of 80 lb (36.3 kg) per unit.
  - 2. Any equipment, ornamentation, building service units, or other rooftop surfacing materials which are not defined as part of the roofing system.

3. Rooftop equipment that does not provide GenFlex with reasonable access to the membrane system for purposes of warranty investigation and related repairs.
  4. Standing water, snow, ice, or other materials unrelated to the roof system.
- L. Warranty coverage is limited to the maximum wind speed indicated on the warranty document as measured 30' (9.1 m) above ground level and does not cover damage that results from failure of other building components, such as dislodged metalwork, wood nailers, rooftop units, or other materials not included in the GenFlex warranty coverage.

#### **1.07 CODES**

- A. GenFlex Roofing Systems has successfully tested its systems at UL and Factory Mutual testing facilities in order to qualify for specific codes and ratings used by designers in the specification of the various roofing systems.
- B. This testing is conducted in strict accordance with the industry recognized standardized testing procedures established and managed by each organization. The purpose of testing assemblies and materials is to evaluate performance capability for each individual component of the roofing system, as well as the performance of the combined assembly.
- C. Because codes and ratings are routinely updated and revised, it is important to consult with a GenFlex Regional Technical Manager, Territory Sales Manager or Sales Representative before quoting a project requiring compliance to a specific code rating. Please visit [www.genflex.com](http://www.genflex.com) for the most current published list of code ratings.
- D. It is the contractor's responsibility to ensure compliance with designer specified code requirements on a project. GenFlex Roofing Systems does not inspect for compliance to code required enhancements to roof systems.



## 1.08 ACCEPTABLE STRUCTURAL ROOF DECKS

GenFlex Roofing Systems has compiled a list of the most common deck types found in the construction field. GenFlex Roofing Systems strongly recommends that you review its requirements and restrictions **prior** to each roofing project. Refer to the following table.

**TABLE 1.08**

<b>New Construction or Tear Off to Deck</b>		
<b>Deck Type</b>	<b>Conditions</b>	<b>Special Requirements (if any)</b>
Steel Deck	22 gauge (0.76 mm) min.	24 - 28 ga (0.61 mm to 0.38 mm) requires submission of pullout test results to determine acceptability (less than 28 ga (0.38 mm) not acceptable).
Structural Concrete	3000 psi (20.7 MPa) min.	If using insulation adhesive to bond to the concrete, the concrete must not be sealed, coated or contain additives (e.g. curing accelerants) without approval from GenFlex.
Lumber	3/4" (19.1 mm) min.	Requires submission of pullout test results to determine acceptability. Refer to pullout test requirements in fastener table 1.10.
Plywood	15/32" (11.9 mm) min.	Must be APA approved material and be fastened with screws to the supporting structure. Requires submission of pullout test results to determine acceptability. Refer to pullout test requirements in fastener table 1.10.
OSB	7/16" (11.1 mm) min.	Must be APA approved material and be fastened with screws to the supporting structure. Requires submission of pullout test results to determine acceptability. Refer to pullout test requirements in fastener table 1.10.
Concrete Plank	2" (50.8 mm) min.	Use caution if drilling in concrete plank to avoid spalling. Requires submission of pullout test results to determine acceptability. Refer to pullout test requirements in fastener table 1.10.
Cementitious Wood Fiber	n/a	Requires submission of pullout test results to determine acceptability. Refer to pullout test requirements in fastener table 1.10.
Gypsum Deck	Poured in place or plank	Requires submission of pullout test results to determine acceptability. Refer to pullout test requirements in fastener table 1.10.
Lightweight Concrete	200 psi (1.4 MPa) min.	Requires submission of pullout test results to determine acceptability. Refer to pullout test requirements in fastener table 1.10. When used as a substrate for an adhered or mechanically attached system, securement must be made through the lightweight concrete and into the structural deck.

## 1.09 ACCEPTABLE ROOF SYSTEM SUBSTRATES

An acceptable substrate will provide a smooth surface capable of fully supporting a GenFlex roof assembly and anticipated roof loads. When used to support an adhered roof system, with either mechanically attached or bonded insulation to the deck, the acceptable insulation substrate must also possess sufficient structural integrity to secure the roofing membrane to the structure when the membrane is bonded to it. Thermal value to the roof assembly, when applicable, must also be considered when choosing an insulation substrate. When insulation is used as a roof substrate, the insulation must be capable of being supported by the structural deck. For example, a typical steel deck would not support 1/2" wood fiber alone but would support an isocyanurate insulation board with a 1/2" wood fiber overlay. A suitable substrate can be an existing roof surface, a structural deck or insulation as detailed in the following table.

**TABLE 1.09A**

<b>IMMEDIATE SUBSTRATE TYPES</b>	
<b>Immediate Substrate Type</b>	<b>Conditions for Use as a Roof System Substrate</b>
<b>Plywood, OSB or Wood Plank Decks</b>	GenFlex roof systems may be installed directly over plywood or OSB, provided the substrate is free of contamination, sharp edges, and protrusions. Wood plank decks require an approved minimum thickness insulation board. The bondable substrate, whether plywood or minimum thickness insulation, must have any voids greater than 1/4" (6.4 mm) between panels filled with a suitable material to provide a smooth, bondable surface. Where plywood is used as a direct substrate, the plywood should be attached to the structural support with screw-type fasteners, instead of nailing, to prevent damage caused by fastener back-out as the structure moves due to expansion / contraction and settling. Damage caused by building movement is excluded from warranty coverage. Pullout tests are required on OSB decks when attachment of insulation and/or membrane is achieved with mechanical securement.
<b>Steel Deck (22 Gauge (0.76 mm) min.)</b>	An approved minimum thickness insulation board must be used. Insulation shall be mechanically fastened with appropriate fasteners and plates. Contact GenFlex for alternative methods to attach insulation to metal decks.
<b>Structural Concrete or Concrete Plank</b>	An approved minimum thickness insulation board is required. Insulation can be mechanically fastened with appropriate fasteners and plates or fastened using alternative methods of insulation securement. GenFlex insulation adhesive is approved for securement when system specifications call for attachment, provided the deck has not been altered by coatings, sealants, or curing accelerants. Asphalt attachment is accepted in some cases for insulation securement but is not covered by the GenFlex warranty.
<b>Lightweight Concrete, Cementitious Wood Fiber or Gypsum</b>	Lightweight concrete, cementitious wood fiber, and gypsum decks must be overlaid with a minimum thickness layer of approved insulation secured directly into the lightweight deck, provided acceptable pullout values are achieved with a GenFast GypTec fastener and insulation plate. Alternative methods of insulation securement include securing the insulation through the lightweight concrete directly to the structural deck or installing a mechanically attached base sheet and mopping-in the insulation. Insulation may also be attached to cementitious wood fiber decks with GenFlex insulation adhesive.
<b>Existing Gravel Surface BUR and Coal Tar Pitch</b>	All loose gravel must be removed or leveled to ensure a relatively flat substrate. An approved minimum thickness insulation board is required and must comply with system requirements for the roof assembly being installed.
<b>Smooth Surface BUR or APP/SBS Modified Bitumen Roof System</b>	For all systems, the existing smooth surface BUR or modified bitumen must be overlaid with a minimum thickness of approved insulation acceptable for use with the system being installed and secured in accordance with the GenFlex published fastening requirements for any given insulation type.  As an exception, a separator sheet or Fleece Backed TPO System may be installed instead of a minimum thickness approved insulation board. Please consult the GenFlex Technical Department regarding suitability of using a separator sheet or Fleece Backed membrane instead of insulation.
<b>Existing Single-Ply Membrane Roofs – All Types</b>	In reroof situations that involve leaving the existing single-ply membrane in place, the existing membrane must be cut into 10' x 10' (3.0 m x 3.0 m) pieces and overlaid with an acceptable rigid insulation board to isolate the new GenFlex single-ply roof system from the original roof membrane. The rigid board type and mechanical securement of the insulation must comply with the securement requirements of the new roof system being installed.
<b>Existing Single-Ply Membrane Roofs – All Types</b>	In reroof situations that involve leaving the existing single-ply membrane in place, the existing membrane must be cut into 10' x 10' (3.05 m x 3.05 m) pieces and overlaid with an acceptable rigid insulation board to isolate the new GenFlex single-ply roof system from the original roof membrane. The rigid board type and mechanical securement of the insulation must comply with the securement requirements of the new roof system being installed.

**TABLE 1.09B**

<b>Acceptable Insulations</b>		
<b>Insulation Type</b>	<b>Manufacturer Names</b>	<b>Minimum Thickness for Use on Mechanically Attached Systems:</b>
Isocyanurate	<b>GenFlex Roofing Systems<sup>A</sup></b>	1/2" (12.7 mm) min.
1/2" HD ISO	<b>GenFlex Roofing Systems<sup>A</sup></b>	1/2" (12.7 mm) min.
Wood Fiber	<b>GenFlex Roofing Systems<sup>A</sup></b>	1/2" (12.7 mm) min.
Expanded Polystyrene	ACH Foam Technologies	n/a
Extruded Polystyrene	Dow Chemical, Owens Corning	1" (25.4 mm) (2)
FanFold	ACH Foam Technologies, Dow Chemical, Owens Corning	3/8"
Gypsum Board	<b>Georgia Pacific (DensDeck)<sup>B</sup></b>	1/4" (6.35 mm)
<p>NOTES:</p> <ol style="list-style-type: none"> <li>Insulation thickness must be minimum thickness required by manufacturer to span openings in the deck. In some cases, it may be necessary to use a support layer of insulation.</li> <li>Except ballast, expanded and extruded polystyrene insulation must be 1.25 lb minimum density and be overlaid with acceptable cover board. Contact GenFlex for other options with expanded and extruded polystyrene insulations.</li> </ol> <p><sup>A</sup><b>Products in bold are covered by the GenFlex warranty when installed in a warranted system.</b></p> <p><sup>B</sup><b>Products in bold italic are covered by the GenFlex warranty when purchased through GenFlex Roofing Systems.</b></p>		

**1.10 ACCEPTABLE GENFLEX FASTENERS**

- A. Warranted GenFlex roof systems must be assembled using GenFast fasteners of appropriate type and length installed at the rate specified in the insulation attachment, and if applicable, the membrane attachment portion of the Installation Section of this specification. The application rate of fasteners specified in the sections mentioned above is based on an approved deck providing 300 lb (1 334.5 N) minimum pullout resistance. For projects with decks requiring pullout testing, a completed pullout test result form is required with the Pre-Job Survey Form in order to register the project with GenFlex.
- B. Minimum fastener penetration requirements into the roof deck are shown on the product data sheet for each fastener type. However, typical fastener penetration requirements are as follows:
  - 1. Steel, wood plank, plywood, OSB, and concrete decks require 1" (25.4 mm) minimum fastener penetration.
  - 2. Gypsum and cementitious wood fiber decks require 1.5" to 2" (25.4 to 38.1 mm) minimum fastener penetration as determined by pullout tests.
  - 3. For deck types other than those listed above, please contact the GenFlex Technical Department.

**TABLE 1.10**

<b>GenFlex Fastener Application Guide</b>														
<b>GenFlex Fastener Type</b>	<b>Approved Accessories</b>	<b>Insulation Attachment</b>	<b>Membrane Attachment</b>	<b>Deck Types</b>										
GenFast #12 Fastener	1	Yes	No	Steel, Wood										
GenFast #14 Fastener	1,4,5,6	Yes	Yes	Steel, Wood										
GenFast #15 (WH) Fastener	1,5,7	Yes	Yes	Steel, Wood, Concrete										
GenFast #16 MAX Fastener	7,10	No	Yes	Steel										
GenFast #12 Preassembled Fastener & Plate	N/A	Yes	No	Steel, Wood										
GenFast #15 Preassembled Fastener & Plate	N/A	Yes	Yes	Steel, Wood, Concrete										
GenFast CD-10 Concrete Fastener	1,4,5,6	Yes	Yes	Concrete										
GenFast Lite-Deck Fastener	2,8	Yes	Yes	Gypsum, Cementitious Wood Fiber										
GenFast Purlin Fastener	5,6	No	Yes	Steel Purlins										
GenFast GypTec Fastener	3,9	Yes	Yes	Gypsum, Cementitious Wood Fiber										
<b>Insulation Plate Options:</b>		1) GenFast Insulation Plate 3) GenFast GypTec Insulation Plate	2) GenFast Lite-Deck Plate											
<b>Membrane Securement Options:</b>		4) GenFast 2" Seam Plate 6) GenFast Bar Anchor 8) GenFast Lite-Deck Bar 10) GenFast 3" MAX Seam Plate	5) GenFast (WH) 2 3/8" Seam Plate 7) GenFast Polymer Batten Strip 9) GenFast GypTec Seam Plate											
<p><b>This is only a partial representation of GenFlex Roofing Systems codes. Please contact the GenFlex Technical Department if you have any code related questions regarding assemblies not referenced.</b></p> <p><b>NOTE:</b> GenFlex fasteners are required on all full system warranties.                      1. GenFlex fasteners are corrosion resistant coated and comply with Factory Mutual Standard 4470.                      2. Insulation fasteners shall be suitable for the insulation used.                      3. All screw type fasteners shall be a minimum #14 shank diameter for membrane securement.                      4. No hex head fasteners are permitted for insulation or membrane securement in GenFlex warranted systems.</p> <p><b>GenFlex Roofing Systems requires a pullout test to be conducted by an independent agency on the following types of decks: gypsum, cementitious wood fiber, oriented strand board, lightweight concrete, concrete plank, and any metal decks lighter than 22 gauge (0.76 mm). The results must be submitted to the GenFlex Technical Department prior to project bid. Fully adhered applications on decks providing less than the required 300 lb (1 334.5 N) of pullout resistance may still qualify for warranty coverage, provided the insulation is secured in accordance with the supplemental securement table on the following page and approved by the GenFlex Technical Department.</b></p> <table border="0"> <tr> <td style="text-align: center;"><u>Roof Size</u></td> <td style="text-align: center;"><u>Pullout Test Requirements</u></td> </tr> <tr> <td>Less than 10,000 ft<sup>2</sup> (929.0 m<sup>2</sup>)</td> <td>6</td> </tr> <tr> <td>10,000 ft<sup>2</sup> - 50,000 ft<sup>2</sup> (929.0 m<sup>2</sup> - 4 645.2 m<sup>2</sup>)</td> <td>10</td> </tr> <tr> <td>50,000 ft<sup>2</sup> - 100,000 ft<sup>2</sup> (4 645.2 m<sup>2</sup> - 9 290.3 m<sup>2</sup>)</td> <td>20</td> </tr> <tr> <td>Over 100,000 ft<sup>2</sup> (9 290.3 m<sup>2</sup>)</td> <td>1 per 5,000 ft<sup>2</sup> (464.5 m<sup>2</sup>)</td> </tr> </table>					<u>Roof Size</u>	<u>Pullout Test Requirements</u>	Less than 10,000 ft <sup>2</sup> (929.0 m <sup>2</sup> )	6	10,000 ft <sup>2</sup> - 50,000 ft <sup>2</sup> (929.0 m <sup>2</sup> - 4 645.2 m <sup>2</sup> )	10	50,000 ft <sup>2</sup> - 100,000 ft <sup>2</sup> (4 645.2 m <sup>2</sup> - 9 290.3 m <sup>2</sup> )	20	Over 100,000 ft <sup>2</sup> (9 290.3 m <sup>2</sup> )	1 per 5,000 ft <sup>2</sup> (464.5 m <sup>2</sup> )
<u>Roof Size</u>	<u>Pullout Test Requirements</u>													
Less than 10,000 ft <sup>2</sup> (929.0 m <sup>2</sup> )	6													
10,000 ft <sup>2</sup> - 50,000 ft <sup>2</sup> (929.0 m <sup>2</sup> - 4 645.2 m <sup>2</sup> )	10													
50,000 ft <sup>2</sup> - 100,000 ft <sup>2</sup> (4 645.2 m <sup>2</sup> - 9 290.3 m <sup>2</sup> )	20													
Over 100,000 ft <sup>2</sup> (9 290.3 m <sup>2</sup> )	1 per 5,000 ft <sup>2</sup> (464.5 m <sup>2</sup> )													
<b>CAUTION: Use appropriate fastener for substrate.</b>														

**1.11 WOOD NAILERS**

Wood nailers provide a termination point for roofing insulation as well as a securement point to tie the roof system into the building shell. Wood nailers are not covered by the GenFlex warranty because they are a product by others and considered part of the building structure. Following are GenFlex’s requirements for wood nailers:

- A. Wood nailers are required at all roof edges where metalwork, drip edges or gutter systems are specified. The width of the nailer must exceed the width of the flange of any metalwork mounted to it and be of equal thickness to the roof insulation in order to protect the edge of the insulation and provide a substrate to which the metalwork can be anchored, without impeding drainage. Wood nailers are also required under any rooftop curbs that are not mounted directly to the structural deck with the same width and thickness requirements stated above.
- B. Wood Nailers must be #2 Grade or better lumber. Wood treated with preservatives containing creosote, asphalt, pentachlorophenol, copper naphthenate, copper 8-quinolinolate, and alkaline copper quaternaries (ACQ) have an adverse effect on single-ply roofing membranes and are not acceptable for use in a GenFlex roofing system.

- C. In all cases, the wood nailer must be anchored to the deck in an industry accepted method to the designing architect's specification. As a minimum standard, the wood nailers must be anchored sufficiently to resist 200 lb (889.6 N) of force per linear foot in any direction with fasteners spaced not more than 24" (609.6 mm) apart. Refer to the Perimeter Flashing portion of Factory Loss Prevention Data 1-49 (June 1985) for nailer securement recommendations. Wood nailers are not part of the GenFlex roofing system and are not covered by the GenFlex warranty.

## PART 2 – PRODUCTS

### 2.01 GENERAL

- A. The components of the GenFlex TPO roofing system are to be products of GenFlex Roofing Systems or approved by GenFlex Roofing Systems as compatible and acceptable. Unless specifically included in the warranty coverage by GenFlex Roofing Systems, products by others are excluded from coverage.

### 2.02 MEMBRANE

- A. GenFlex TPO membrane is available in a variety of membrane thickness and sheet width combinations that are illustrated in the table in Section 2.02 of the GenFlex Roofing Systems Design Criteria. Not all sheet widths shown are stock items. Consult your GenFlex Customer Service Representative regarding lead time for nonstock sheet length / width combinations.

### 2.03 RELATED MATERIALS

The following list contains the names of other GenFlex products and accessories that may be required in order to complete the roofing system. With the exception of walkway pads, which are considered maintenance items, GenFlex manufactured or supplied material is covered in the limited warranty, provided a warranty is purchased for the project.

**Note:** Prolonged exposure of adhesives and sealants to temperatures greater than 80 °F (27 °C) will reduce their shelf life. Shelf life is indicated on the product label or in the product information data for the particular product item, which can be found at [www.genflex.com](http://www.genflex.com).

#### TPO

A. TPO Non-Reinforced Flashing	24" x 50' (609.6 mm x 15.2 m)
B. TPO Inside/Outside Corner	1 size / 10 per ctn
C. TPO Reinforced Outside Corner	12" x 12" (304.8 x 304.8 mm) / 10 per ctn
D. TPO Molded Pipe Boot	1" to 6" (25.4 to 152.4 mm) / 10 per ctn
E. TPO Pipe Boot - Small	1" to 3" (25.4 x 76.2 mm) / 10 per ctn
F. TPO Pipe Boot - Large	3" to 6" (76.2 x 152.4 mm) / 10 per ctn
G. TPO T-Joint Cover	4.5" (114.3 mm) diameter / 100 per ctn
H. GenPocket T	6" (152.4 mm) diameter / 6 per ctn
I. TPO Heat Weldable Walkway Pad	30" x 50' (762.0 mm x 15.2 m) / 1 roll
J. TPO Coated Metal	4' x 10' (1.2 x 3.0 m) / 10 sheets per pallet
K. Peel & Stick TPO RPS (Reinforced Perimeter Strip)	6" x 100' (152.4 mm x 30.5 m) / 2 rolls per ctn
L. Peel & Stick TPO RMA (Roof Membrane Attachment Strip)	10" x 100' (254.0 mm x 30.5 m) / 1 roll per ctn
M. TPO Seam Tape	3" x 50' (76.2 mm x 15.2 m) / 4 rolls per ctn / 3" x 100' (76.2 mm x 30.5 m) / 1 roll per box, 6 box per ctn
N. Clear Primer	3 gal (11.4 L) or 1 qt. (0.9 L) can
O. Clear Primer LVOC	1 gal (3.8 L) / 4 pails per ctn or 3 gal ( 11.4 L) pail
P. Substrate Primer	1 gal (3.8 L) / 4 pails per ctn
Q. TPO Cover Tape	5.5" x 25' (139.7 mm x 7.6 m) / 1 roll per box, 4 box per ctn
R. Peel & Stick TPO Pipe Boot	1" to 6" (25.4 to 152.4 mm) / 8 per ctn
S. Scrub Pad & Handle	3" x 5" (76.2 x 127.0 mm) / 30 pads & 4 handles per ctn
T. TPO Bonding Adhesive	5 gal (18.9 L) pail
U. TPO Bonding Adhesive LVOC	5 gal (18.9 L) pail
V. FB Bonding Adhesive (LVOC)	5 gal (18.9 L) pail
W. TPO Edge Sealant	16 fl oz (532.3 mL) / 12 bottles per ctn
X. TPO Edge Caulk LVOC	11 fl oz (325.3 mL) / 12 tubes per ctn

## UNIVERSAL ACCESSORIES

Insulation	Polyiso (flat or tapered), 1/2" HD ISO, Wood Fiber
GenFast Fastener	#12, #14, #15 (WH), #16 MAX, CD-10, Purlin, Lite-Deck, GypTec / quantity per ctn varies
GenFast Insulation Plate	3" Round, Lite-Deck, GypTec / quantity per ctn varies
GenFast Seam Plate	2", 2 3/8" (WH), 3" MAX, GypTec, RF, AS / quantity per ctn varies
GenFast Bar Anchor	1" x 10' (25.4 mm x 3.0 m) / 50 per tube
GenFast Polymer Batten Strip	1" x 250' (25.4 mm x 76.2 m)
GenFast Lite-Deck Bar	1" x 10' (25.4 mm x 3.0 m) / 500' (152.4 m) per tube
GenFast Preassembled Fastener & Plate	#12, #15 / quantity per ctn varies
Cleaner	5 gal (18.9 L) pails
One Step Insulation Adhesive	200 ft <sup>2</sup> (18.6 m <sup>2</sup> ) per ctn for 4" (101.6 mm) o.c. bead 300 ft <sup>2</sup> (27.9 m <sup>2</sup> ) per ctn for 6" (152.4 mm) o.c. bead 600 ft <sup>2</sup> (55.7 m <sup>2</sup> ) per ctn for 12" (304.8 mm) o.c. bead
All Purpose Bonding Adhesive	45 to 60 ft <sup>2</sup> /gal (1.1 to 1.5 m <sup>2</sup> /L) of finished surface
All Purpose Water Based Bonding Adhesive	120 ft <sup>2</sup> /gal (2.9 m <sup>2</sup> /L) / 1, 3.5 or 5 gallon pail (3.8, 13.2 or 18.9 L)
Pourable Sealer (A & B)	1 ft <sup>2</sup> /gal at 2" thick (0.02 m <sup>2</sup> /L at 50.8 mm thick)
Water Stop	15 lf (4.6 m) per tube / 12 tubes per ctn
Termination Caulk	24 lf (7.3 m) per tube / 12 tubes per ctn
GenFast Termination Bar	1.25" x 10' (31.8 mm x 3.0 m) / 50 per ctn
GenFast Zinc Masonry Anchor	1 1/4" (31.8 mm) / 1000 per ctn
Separator Mat	4.5 oz nominal per yd <sup>2</sup> (152.6 g per nominal m <sup>2</sup> ) 15' x 320' (4.6 m x 97.5 m)

**CONSULT THE PRODUCT DATA SHEETS AVAILABLE ONLINE AT [WWW.GENFLEX.COM](http://WWW.GENFLEX.COM) FOR ADDITIONAL PRODUCT INFORMATION.**

## PART 3 – INSTALLATION

### 3.01 SUBSTRATE CRITERIA

- A. The building owner or owner's representative is responsible for providing and determining that the substrate is suitable to receive the GenFlex TPO roofing system. The GenFlex Licensed Contractor should not proceed until any and all defects have been corrected. If possible, begin roof installation at the high point of the roof, and work toward the lowest point.

### 3.02 SUBSTRATE PREPARATION

- A. In a reroofing application, the building owner or owner's representative is responsible for making sure that all wet insulation and/or wet substrate has been removed and replaced. The best diagnostic technique to determine this is to take a series of roof core cuts and analyze them for moisture content and degradation. Two other techniques are currently available and make this determination by indirect means: nuclear moisture detection and infrared thermography. These techniques provide measurements of factors that can be associated with the presence of moisture.
- B. A positive slope is recommended to provide adequate drainage. The National Roofing Contractors Association Manual recommends that there should be no ponding water on the roofing system forty-eight (48) hours after it has stopped raining. Positive drainage is a design feature and should be addressed in the planning stage of the project. Under no circumstances is GenFlex Roofing Systems responsible for ponding water as GenFlex is not party to the structural design of the building.
- C. Any existing sprayed-in-place urethane foam roofs **must** be removed down to the structural deck prior to the installation of a GenFlex roofing system.
- D. Sweep the area of roof being covered to remove any loose dirt and debris.

### 3.03 INSULATION APPLICATION

- A. Identify the area of roof being addressed in the workday, and lay out insulation with edges resting on the upper deck flute for metal decks and flat on supporting substrate for other types of decks.
- B. Stagger all insulation joints the maximum amount possible and lay out with all joints tightly butted. Any gaps greater than 1/4" (6.4 mm) wide must be filled with matching insulation material.

- C. When installing insulation greater than 2 1/2" (63.5 mm) thick, use multiple layers to maximize insulation thermal efficiency.
- D. When using multiple layers of insulation on a project, install each subsequent layer with the long axis running perpendicular to the layer below it and with all joints staggered and tightly butted.
- E. Fit insulation tightly to roof penetrations, wood nailers, transitional walls and parapets with any gaps greater than 1/4" (6.4 mm) filled with like material prior to membrane application.

### 3.04 INSULATION SECUREMENT

- A. Insulation attachment defined below is based on 300 lb (1 334.47 N) pullout resistance or greater.  
**Note:** In the event the insulation is installed over an air barrier, the insulation securement must be in accordance with FM I-90 criteria for GenFlex fully adhered roof systems.
  - 1. All insulation must be mechanically attached to the approved structural deck using GenFlex fasteners of appropriate type and length and insulation plates installed at the rate of one fastener and plate per 6.5 ft<sup>2</sup> (0.6 m<sup>2</sup>), or 5 fastener assemblies per 4' x 8' (1.2 m x 2.4 m) board for 22 ga (0.76 mm) steel decks or structural concrete. Other decks require pull testing and may require additional securement. Fasten all insulation per detail drawing T-42.08r.

### 3.05 MEMBRANE APPLICATION

- A. Membrane
  - 1. Position the GenFlex TPO membrane over the approved substrate without stretching.
  - 2. Allow the membrane to relax a minimum of one-half (1/2) hour prior to any seaming or flashing.
  - 3. Position all adjoining sheets in a manner that all sheets overlap a minimum of 4 1/2" (114.30 mm).

### 3.06 MEMBRANE ATTACHMENT AND SEAMING PROCEDURES

The seaming methods available for TPO mechanically attached roof systems are single weld and dual weld. The significant difference between the two types of hot air welded seams is the way they distribute wind load from the roofing membrane sheet to the anchoring assemblies in the structural roof deck.

The dual weld seam configuration distributes an even, bidirectional load on the anchor bar seam anchoring system. This results in a higher wind load tolerance than the unidirectional load applied to the seam plate anchoring system used in the single weld assembly.

The required seaming method for the TPO mechanically attached roof system is determined by the following factors: design codes and approvals on the specified roof system, width of the roofing sheets being installed, and warranty wind speed being sought for the project.

**Note: It is very important that both surfaces are clean and no moisture is present on the splicing surfaces.**

- A. Position the top membrane to overlap the bottom membrane by 4 1/2" (114.30 mm) .
- B. If seam area has become contaminated with dirt or debris, use a clean rag saturated with GenFlex Cleaner and thoroughly clean an area on both sheets at least 4" (101.6 mm) wide. Change rags frequently to avoid depositing previously removed materials. Allow cleaner to flash-off completely prior to seaming.
- C. When seaming thermoplastic single-ply membranes, practice welds are highly recommended in order to set up the hot air welding equipment properly.

**For Projects Utilizing Single Weld Seaming** (See Detail T-42.02sw.)

- D<sub>1</sub>. Fold back the top sheet without creasing, and position the GenFlex seam plate on the appropriate dots that have been applied at 6" (152.4 mm) intervals to the seam area of the bottom sheet. Fasten with the appropriate GenFast fasteners. For fastener spacing requirements, refer to the GenFlex web site for the current GenFlex fastener matrix for the system being installed, or contact the GenFlex Technical Department. Refer to details T-42.04-1 through T-42.04-3 for perimeter and corner fastening requirements.
- E<sub>1</sub>. Using an approved automatic heat welding machine or hand held heat gun and silicone roller, continuously weld a minimum 1 1/2" (38.1 mm) wide seam. GenFlex recommends that only approved automatic walker welders be used to weld all field seams. See Hot Air Welder Specifications.

**For Projects Utilizing Dual Weld Seaming** (See Details T-42.02dw)

**Note:** Dual weld seaming cannot be used with GenFlex Fleece Backed TPO Membrane.

- D<sub>2</sub>. Fold back the top sheet without creasing, and position GenFast Bar Anchor or GenFast Polymer Batten Strip in the center of the seam, directly over the fully adhered line of the bottom sheet, and secure using only GenFast #15 (WH) Fasteners. See detail T-6.03. Care must be taken when placing the bar where there are no factory line markings. Fasteners must be located precisely 2" (50.8 mm) in from the edge of the top sheet at the correct spacing interval. This alignment will provide a 1 1/2" (38.1 mm) weld area past the bar.

Too much material overlap may result in a non-welded seam, requiring the seam to be repaired. Refer to the GenFlex web site for the current GenFlex fastening matrix for the system being installed, or contact the GenFlex Technical Department. Refer to details T-42.04-1 through T-42.04-3 for perimeter and corner flashing requirements.

All bars are to be overlapped and secured with a common screw. **Note:** Contact the GenFlex Technical Department for bar anchor overlap requirements on FM projects.

- E<sub>2</sub>. Using a GenFlex approved automatic welder modified for dual weld applications, continuously weld a minimum 1" to 1 1/4" (25.4 mm to 31.8 mm) wide weld on both sides of the GenFast Bar Anchor or GenFast Polymer Batten Strip in the seam.
1. Hot air equipment, approved by GenFlex and designed for use in dual weld seaming, will track over the bar anchor, welding on both sides. It is important that the operator maintain a visual check to make sure the machine is not riding on the anchor bar. Proper alignment of the bar anchor in the seam area is critical to achieve minimum 1" (25.40 mm) welds on both sides of the bar.
  2. When welding stops and starts in a dual weld seam, a dual weld must be achieved by using a hand held welder.  
**Note:** Hot air flow between the dual welds will cause a slight rise in the material over the anchor bar, indicating that a weld has been achieved on both sides of the anchor bar. This condition will diminish over time.
- F. Special attention must be paid to areas where multiple layers (3 or more) of TPO field membrane come together (T-joints).
1. T-Joint Covers are **recommended** for applications involving 45 mil (1.14 mm) membrane if probing reveals the presence of voids or cold welds and are **required** for applications involving 60 mil (1.52 mm) membrane regardless of probing results. T-joint covers are marketed by GenFlex in packages of pre-cut covers or can be field formed by cutting 4" x 4" (101.6 mm x 101.6 mm) pieces from a roll of GenFlex TPO Non-Reinforced Flashing
  2. A GenFlex TPO T-Joint Cover or 4" x 4" (101.6 mm x 101.6 mm) pieces of GenFlex TPO Non-Reinforced Flashing shall be used in areas where three (3) or more layers of TPO membrane intersect (T Joints).
  3. Clean the area where the T-joint cover will be applied thoroughly with GenFlex Cleaner. The area should be 6" (152.4 mm) round and have the intersection of the T-joint at its center point.
  4. Position the T-joint cover so that it is centered on the T-joint.
  5. Hot air weld the T-joint cover into place in accordance with GenFlex hot air welding requirements.
  6. Allow the hot air welded T-joint cover to cool thoroughly, and then probe its edges to be certain of a solid weld.
  7. Repair voids or cold welds as necessary to obtain a solid weld between T-joint cover and the underlying TPO membrane layers.
- G. Once cooled, all welded seams must be manually checked for voids or seal deficiencies with a dull cotter key extractor or other acceptable blunt tip metal probe. In addition, there must be destructive testing performed at the beginning of every workday and every time there is an interruption in the welding process. (E.g. Power failure, welder shut down, change in job site conditions, or after lunch). All deficiencies must be repaired.
- H. Any wrinkles found in the splice area or that impede the flow of water drainage must be cut out, laid flat and repaired using one of the following options.
1. Apply GenFlex TPO Cover Tape according to current GenFlex repair procedures.
  2. For small repairs, hot air weld 4" x 4" (101.6 mm x 101.6 mm) standard TPO membrane patches that extend a minimum of 2" (50.8 mm) past the repair area in all directions.
  3. When a repair requires a cover material larger than GenFlex Cover Tape or small membrane patches, use standard TPO membrane to overlay the repaired wrinkle. When using standard TPO membrane, the perimeter of the cover must be seamed to the field membrane with a minimum 1.5" (38.1) hot air weld. The center area of any field membrane repair cover must be bonded to the field membrane with approved adhesive.
- I. All TPO membrane cut edges with exposed reinforcement scrim require an application of GenFlex TPO Edge Sealant by the end of the workday in which the membrane with the raw edge is installed in the roofing system. Failure to seal the raw membrane edge before moisture wicks into the scrim may result in an inferior hot air weld if not already welded, and/or a leak source, depending on the location of the cut edge in relation to fasteners penetrating the membrane. Issues relating to unsealed edges will be corrected by the installing contractor at the contractor's expense as either a punch list item or under their two-year obligation if identified by GenFlex within twenty-four (24) months of approved final inspection.



### 3.07 PERIMETER AND BASE MEMBRANE SECUREMENT

- A. Regardless of the method used to secure the field of the roofing membrane, some points on every roof require additional membrane securement. These areas include roof perimeters (parapets, transitional walls and edges), deck angle changes in excess of 2°/12" (including drain sump areas), all curb-type roofing penetrations, pipe-type penetrations greater than 12" (304.8 mm) in diameter, both sides of expansion joints and other areas where the membrane must be anchored to prevent movement, stress or damage to the roofing membrane. Refer to the TPO standard details in this manual for securement requirements.

#### Perimeter Attachment

1. GenFlex Roofing Systems offers several different types of attachment methods. Consult the appropriate GenFlex standard detail section of this manual.
  2. Base attachment is required at each roof level, curb skylight, expansion joint and roof penetration over 12" (304.8 mm) in diameter or any angle change in slope or combined slopes that exceed 2° (50.8 mm) in 12" (304.8 mm).
- B. Wood nailers provide a termination point for roofing insulation as well as a securement point for base flashing securement. Wood nailers are not covered by the GenFlex warranty because they are a product by others and considered part of the building structure. Following are GenFlex's requirements for wood nailers:
1. Wood nailers are required at all roof edges where metalwork, drip edges, or gutter systems are specified. The width of the nailer must exceed the width of the flange of any metalwork mounted to it and be of equal thickness to the roof insulation in order to protect the edge of the insulation and provide a substrate to which the metalwork can be anchored, without impeding drainage. Wood nailers are also required under any rooftop curbs that are not mounted directly to the structural deck with the same width and thickness requirements stated above.
  2. Wood Nailers must be #2 Grade or better lumber. Wood treated with preservatives containing creosote, asphalt, pentachlorophenol, copper naphthenate, copper 8-quinolinolate, and alkaline copper quaternaries (ACQ) have an adverse effect on single-ply roofing membranes and are not acceptable for use in a GenFlex roofing system.
  3. In all cases, the wood nailer must be anchored to the deck in an industry accepted method to the designing architect's specification. As a minimum standard, the wood nailers must be anchored sufficiently to resist 200 lb (889.6 N) of force per linear foot in any direction with fasteners spaced not more than 24" (609.6 mm) apart. Refer to the Perimeter Flashing portion of Factory Loss Prevention Data 1-49 (June 1985) for nailer securement recommendations. Wood nailers are not part of the GenFlex roofing system and are not covered by the GenFlex warranty.

### 3.08 FLASHINGS (REVIEW THE APPROPRIATE FLASHING DETAIL IN DETAIL SECTION OF THIS MANUAL.)

- A. Roof perimeter flashing and flashing around vents, skylights and miscellaneous roof projections must utilize GenFlex pre-molded TPO flashings to the greatest extent possible. Field fabricated detail flashings using GenFlex TPO Non Reinforced Flashing are acceptable only when a pre-molded flashing is unfeasible, such as on pipes without top access.

GenFlex Roofing Systems offers numerous options for flashing. See our standard details.

1. Vertical Membrane Flashings (Parapets, Transitional Walls, Curbs, etc.)

Wall, parapet, and/or curb flashings may be completed using standard TPO membrane or Peel & Stick TPO membrane equal in gauge (thickness) to the deck membrane.

- a. Complete seams between the flashing membrane and the field membrane according to GenFlex hot air welding procedures.
- b. Stir GenFlex bonding adhesive thoroughly. Achieve a uniform mix with no marbling and no sediment on the bottom of the pail.
- c. Apply GenFlex bonding adhesive to both the flashing material and the vertical substrate to which it is being bonded. See Section 2.03 of this specification for coverage rates of GenFlex bonding adhesives.
- d. Allow adhesive to flash-off until the surface of the adhesive-coated membrane flashing feels tacky but does not transfer to a clean dry finger or "slide" when a push test is performed.
- e. Roll the prepared flashing membrane into the angle change, avoiding both sharp creases and excessive bridging, and continue up the vertical substrate without wrinkles, creases or trapped air, while smoothing the flashing to the substrate with a sweeping motion of your hand to promote a positive bond. **Note:** Allow flashing membrane to bridge slightly at the deck to vertical substrate junction equal to the amount that will still allow a rubber or silicone hand seam roller to make contact with both the vertical and horizontal membrane surfaces simultaneously.

- f. Once the flashing has been preliminarily bonded to the vertical substrate by hand, sweep the flashing material with a medium-stiff bristle broom to finish the bonding process.
    - g. Terminate top edge of flashing per GenFlex Roofing Systems standard TPO details.
  2. Flashing penetrations passing through the roofing membrane.
    - a. Flash all pipes with GenFlex pre-molded pipe boots to the greatest extent possible. Field fabricate pipe flashings with GenFlex TPO Non-Reinforced Flashing per standard GenFlex Roofing Systems details when a pre-molded flashing is not feasible. **Note:** All existing flashings must be removed before applying a new flashing.
- B. Expansion Joints and Building Control Joints.
  1. Consult GenFlex Roofing Systems standard details for various application methods: T-11.01, T-11.02, T-11.03, and T-11.04.
- C. Pitch Pans
  1. Fill pitch pans in accordance with GenFlex Roofing Systems standard details: T-9.01, T-9.02, T-9.03, and T-9.05.
- D. Roof Drains
  1. Consult GenFlex Roofing Systems standard details T-8.01 and T-8.02.
  2. Prepare substrate around each roof drain to prevent membrane bridging or distortion and to provide a smooth transition from the roof surface to the drain clamping ring.
  3. The surface between the clamping ring and the drain must be clean and smooth. Remove all existing flashing, cement or lead on retrofit projects down to bare clean metal.
  4. Apply one (1) complete tube of GenFlex Water Stop between drain bowl compression flange and the underside of the new membrane before compressing the new membrane to drain bowl assembly, with the compression ring mounted on the top surface of the new membrane. The detail is only complete when the water stop is fully compressed between the new membrane and the flange of the drain bowl, forming a solid seal between the two. Be careful to compress the assembly evenly to avoid cracking or breaking the drain compression ring. Cracked or broken drain compression rings may result in a reinspection of the finished roof system to make certain corrective measures have been made before GenFlex will accept the roof system for warranty coverage.
  5. **All bolts and/or clamps must be in place in order to provide constant, even compression.** Missing drain bolts may result in a reinspection of the finished roof system to make certain corrective measures have been made before GenFlex will accept the roof system for warranty coverage.
  6. Do not run seams through roof drains or sumps. If a seam is run through a drain sump, cut the membrane with the assembled seam outside of the drain compression ring area, and install a target patch of new membrane extending a minimum of 3" (76.2 mm) outside of the sump area and seamed into the field membrane, using GenFlex standard hot air welding procedures. Apply T-joint covers as required at the target patch to seam intersections in accordance with GenFlex standard T-joint application procedures.
- E. Scuppers
  1. Scuppers are to be constructed according to criteria detailed in the Sheet Metal and Air Conditioning Contractors National Association (SMACNA) Manual.
  2. As a minimum, GenFlex requirements regarding scuppers are as follows: the scupper assembly must be fabricated from a minimum of 24 ga (0.45 mm) G-90 steel, 0.040" (1.02 mm) aluminum, or GenFlex TPO Coated Metal and be sized to fit snugly through the wall opening. All joints must be sealed according to SMACNA standards, and the scupper must include a continuous 3" (76.2 mm) wide interior face flange with continuous rounded corners. The scupper must also be of sufficient length to extend through the exterior wall by at least 1/2" (12.7 mm), and be capable of being sealed on the exterior of the building to prevent backflow into the roof system or wall cavity.
  3. In addition to the above, if a scupper is to be mounted at the deck to wall or parapet junction, a wood nailer of equal thickness to the roofing insulation must be secured to the structural deck below the scupper flange to provide a suitable mounting surface for the scupper.
  4. Cut the flashing membrane tightly to the scupper opening in the wall.
  5. Apply a heavy bead of Water Stop around the scupper opening (15 lf (4.6 m) per tube).
  6. Insert the scupper sleeve into the scupper opening, and press the mounting flange into the Water Stop.
  7. Secure the flange to the substrate with an appropriate fastener.
8. Flash scupper in accordance with the appropriate current GenFlex scupper detail.

## F. Metalwork

1. Metalwork is not waterproofing. The installed membrane and roofing system must be made watertight before metal application.
2. No roof system is complete until all the edges are terminated in such a way as to prevent water infiltration into the roofed structure. This typically involves the use of manufactured or shop fabricated metal detailing, such as coping caps, gravel stops, roof edging, flashing and counter-flashing components. All metalwork should be fabricated and installed according to SMACNA and National Roofing Contractors Association (NRCA) guidelines. Unless specifically agreed to in writing by the GenFlex Technical Department prior to installation, metalwork manufactured by others is not included in the GenFlex warranty coverage.
3. The designer and roofing contractor should be aware that many municipalities and states are beginning to enforce metal codes that, until recently, were merely used as guidelines. These metal codes relate to minimum standards on material, fabrication, and testing of roof related metalwork. It is the contractor's responsibility to review and know the building codes relating to their roofing projects in order to avoid costly remedial work to bring a project into compliance.
4. If the metalwork on a project is specified by the designer to be included in a full system warranty, use GenFlex brand edge metal and coping products. Contact your Territory Sales Manager or Sales Representative for information.
5. If a metal flashing product by others is submitted via a deviation request for inclusion in the warranty coverage, the following are minimum requirements for consideration:
  - a. The metalwork must be shop or factory formed or extruded.
  - b. The metalwork must be configured and installed in accordance with SMACNA guidelines and NRCA installation instructions.
  - c. Minimum requirements regarding metalwork material are, 24 ga (0.61 mm) G-90 Kynar pre-finished steel or 0.040" (1.02 mm) aluminum (mill finished, pre-finished or anodized).
  - d. A deviation request for inclusion of metalwork in warranty coverage must accompany the Pre-Job Survey form submitted by the installing contractor.
  - e. The deviation request must include shop drawings of the metalwork to be included and a roof plan showing the installed location and linear dimension for each profile.
  - f. Should the deviation request be granted, the installing contractor will be responsible to GenFlex Roofing Systems for a period of two-years from the date of GenFlex inspection and acceptance under their installers agreement.
6. Metalwork installation, regardless of material source, must be according to the metalwork manufacturers instructions available from the manufacturer or supplier.
  - a. Metalwork formed by roofing contractors must be fabricated and installed in accordance with SMACNA and NRCA recommendations. All flange-mounted metalwork must be flashed according to the appropriate GenFlex material type's standard details. Metalwork formed by contractors is not eligible for warranty coverage unless the conditions listed under item "C" above are met and GenFlex accepts the metalwork for warranty coverage in writing.
  - b. Metalwork by roofing contractors must have metal joints stripped-in to the uppermost edge of the metal dam on the roof side.
  - c. TPO projects with cover tape flange strip-in of metalwork with a gravel dam (or a formed configuration that is capable of holding water on the edge of the installed cover tape) must have GenFlex TPO Edge Caulk applied on both sides of the cover tape.
  - d. Gravel stop style metalwork on TPO roof systems may be fabricated from GenFlex TPO Coated Metal in order to provide a suitable welding surface to seal the roof system to the metalwork. As an alternative on some TPO applications, it may be appropriate and permissible to use a two-piece snap on fascia assembly instead of clad metal. Consult your GenFlex Regional Technical Manager for options.
7. The approval of metalwork for inclusion in warranty coverage is conditional upon acceptance by GenFlex Roofing Systems, and, if approved, is subject to the "terms, conditions and limitations" of the requested warranty. Under no circumstance will any warranty coverage for metalwork exceed the wind speed limitation of the warranty issued for the roof system. Aesthetic appearance is expressly excluded from warranty coverage.
8. Metalwork by others is not permitted on projects requiring full system warranties and wind speed coverage equal to, or greater than, 90 mph (144.8 km/h).

#### G. Night Seal

1. Consult GenFlex Roofing Systems standard detail T-19.03.
2. At the completion of each day's work, a watertight seal must be established at any loose edge of membrane with an appropriate sealant. Care must be used to guarantee that no water flows beneath any completed sections of roof. Consult GenFlex Roofing Systems standard night seal detail for method of attachment. Membrane contaminated with the sealant used as a night seal must be cut out and discarded prior to resumption of work.

### 3.09 WALKWAYS

- A. Consult GenFlex Roofing Systems standard detail T-16.04.
- B. Walkways are required at all access points to the roof system and recommended anywhere routine (routine is defined as once a month or more) traffic on the membrane surface is anticipated. Walkway pads are used to protect the weatherproofing membrane from damage or excessive wear and tear. Traffic-related roof damage is not covered by the GenFlex warranty. In areas of extreme traffic, contact GenFlex for options to enhance the roof system in order to prevent or mitigate traffic-related insulation damage. Walkway maintenance is the responsibility of the building owner because walkway pads are not part of the warranted waterproofing assembly.
- C. Should access to the roofing membrane be required in order to perform warranty service to the roof system, only GenFlex brand walkway pads will be moved and replaced as necessary to perform service at GenFlex's expense. Pavers, walkway systems, patio surface components and other products neither manufactured or supplied by GenFlex Roofing Systems that impede roof system service must be removed and replaced at the building owner's expense. Should the obstacle removal and replacement be performed by the GenFlex contractor servicing a leak call under building owner authorization and/or purchase order, GenFlex assumes no responsibility or liability for the performance of the contractor in performing that service.

### 3.10 FINISHED ROOF PROTECTION

- A. When it becomes necessary for other trades to work over a completed area of new roof, the roofing membrane and flashing must be protected from physical damage. Proper and adequate protection includes installing a slip-sheet in the work area overlaid with plywood or OSB, in order to dissipate the effects of traffic on the finished roof surface and to prevent impact damage to the system caused by dropped tools and/or equipment. If damage does occur to the roof system, it must be repaired immediately in order to preserve the integrity of the roof system. If membrane is damaged in more than six (6) locations within a 100 ft<sup>2</sup> (9.3 m<sup>2</sup>) area, new membrane extending 6" (152.4 mm) beyond the border of the damaged areas must be installed over existing membrane in accordance with GenFlex specifications. For fully adhered and mechanically attached applications, the membrane must be fully bonded with the existing underlying membrane with a GenFlex approved adhesive. Contact the GenFlex Technical Department with any questions on how to address comprehensive damage.

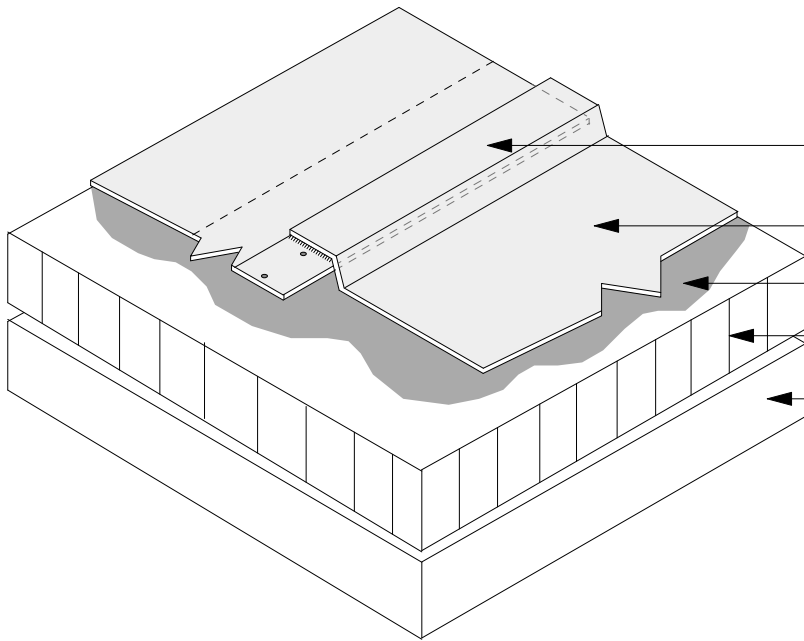

1 1/2" Min. (38.1 mm) Hot Air Weld\*

GenFlex TPO Membrane

GenFlex TPO Bonding Adhesive  
(If Adhered System)

GenFlex ISO

Approved Substrate

\*For Adhered and Ballasted Systems, position adjacent membrane panels on the factory-applied solid reference line.

**GenFlex**

07/10

**Hot Air Welded Seam**

**Detail #: T-6.01**

**TPO Systems**  
(For Adhered & Ballasted Applications and End Laps on Mechanically Attached Systems)

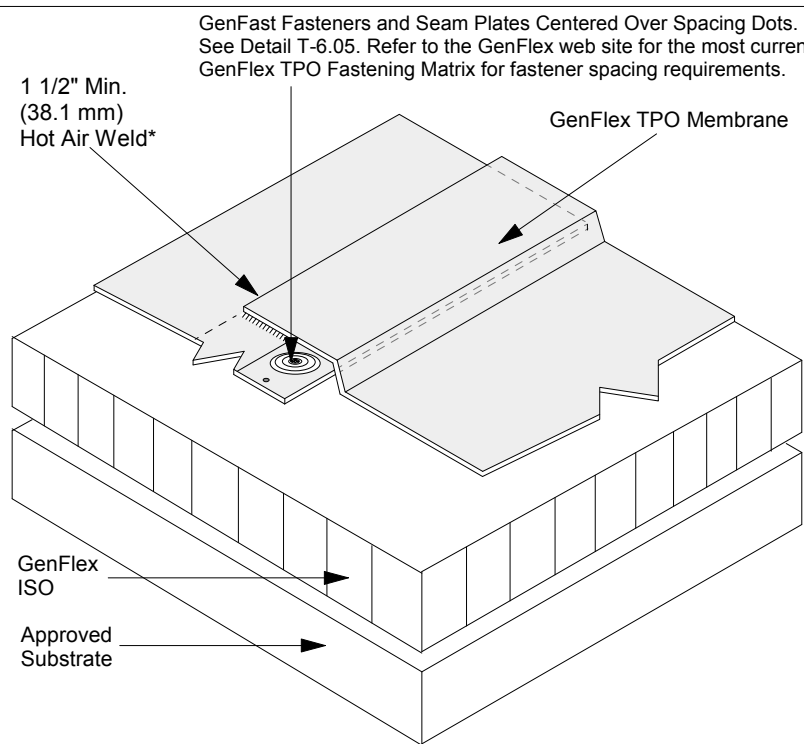

1 1/2" Min.  
(38.1 mm)  
Hot Air Weld\*

GenFast Fasteners and Seam Plates Centered Over Spacing Dots. See Detail T-6.05. Refer to the GenFlex web site for the most current GenFlex TPO Fastening Matrix for fastener spacing requirements.

GenFlex TPO Membrane

GenFlex  
ISO

Approved  
Substrate

\*Position adjacent membrane panels on the factory-applied dashed reference line, and install membrane securement as required, centered over fastener and spacing dotted reference line.

**Layout Lines**

**6' & 12' Panels**

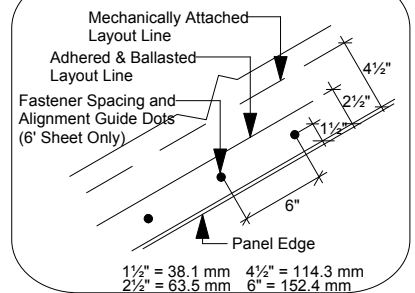

**8' & 10' Panels**

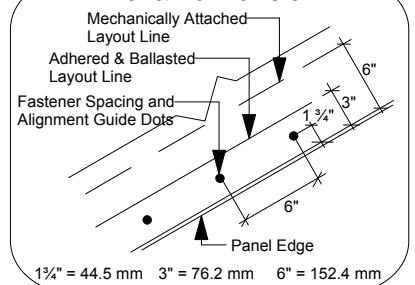

**GenFlex**

07/10

**Single Weld Seam**

**Detail #: T-6.02**

**TPO Mechanically Attached Systems**

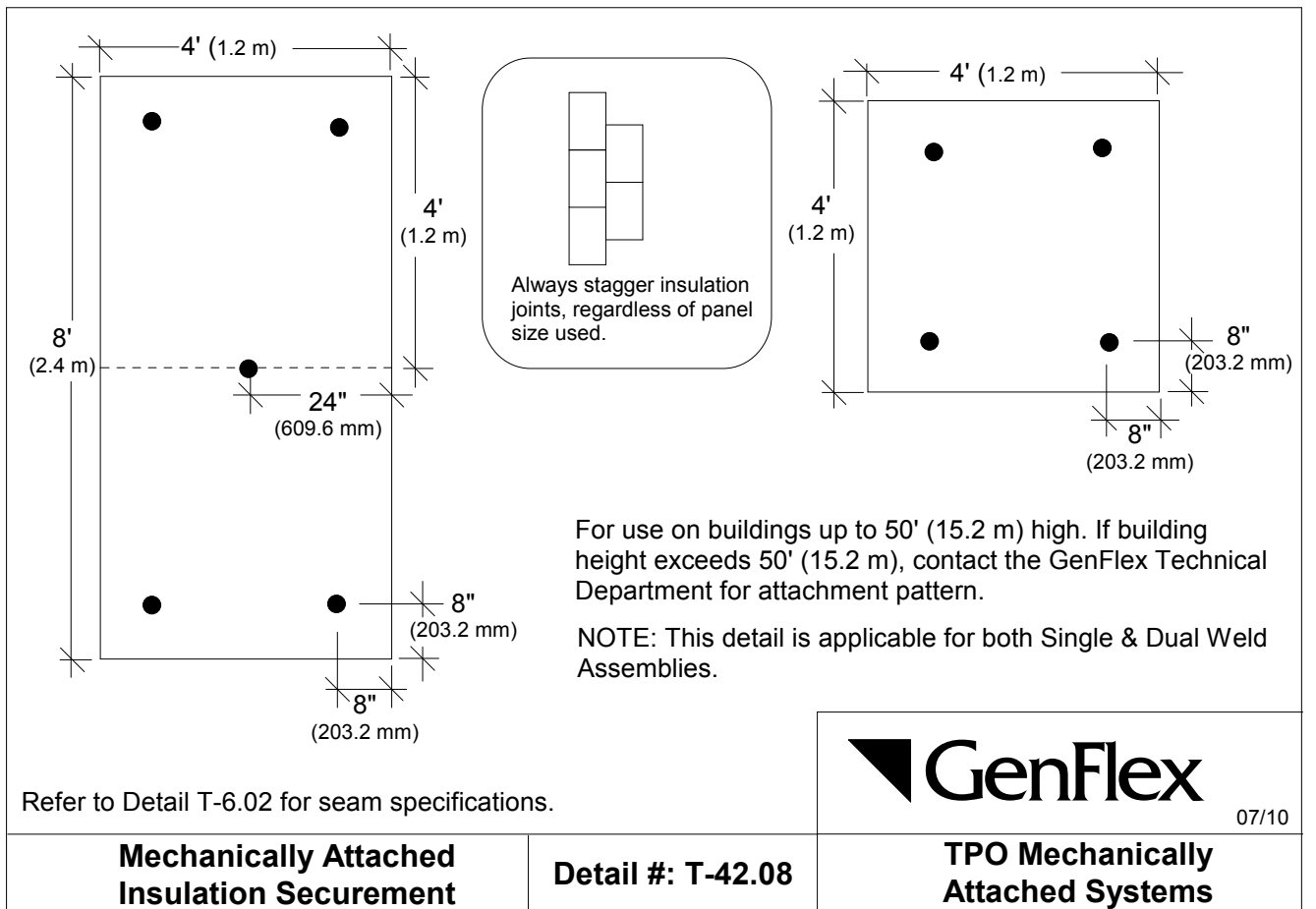
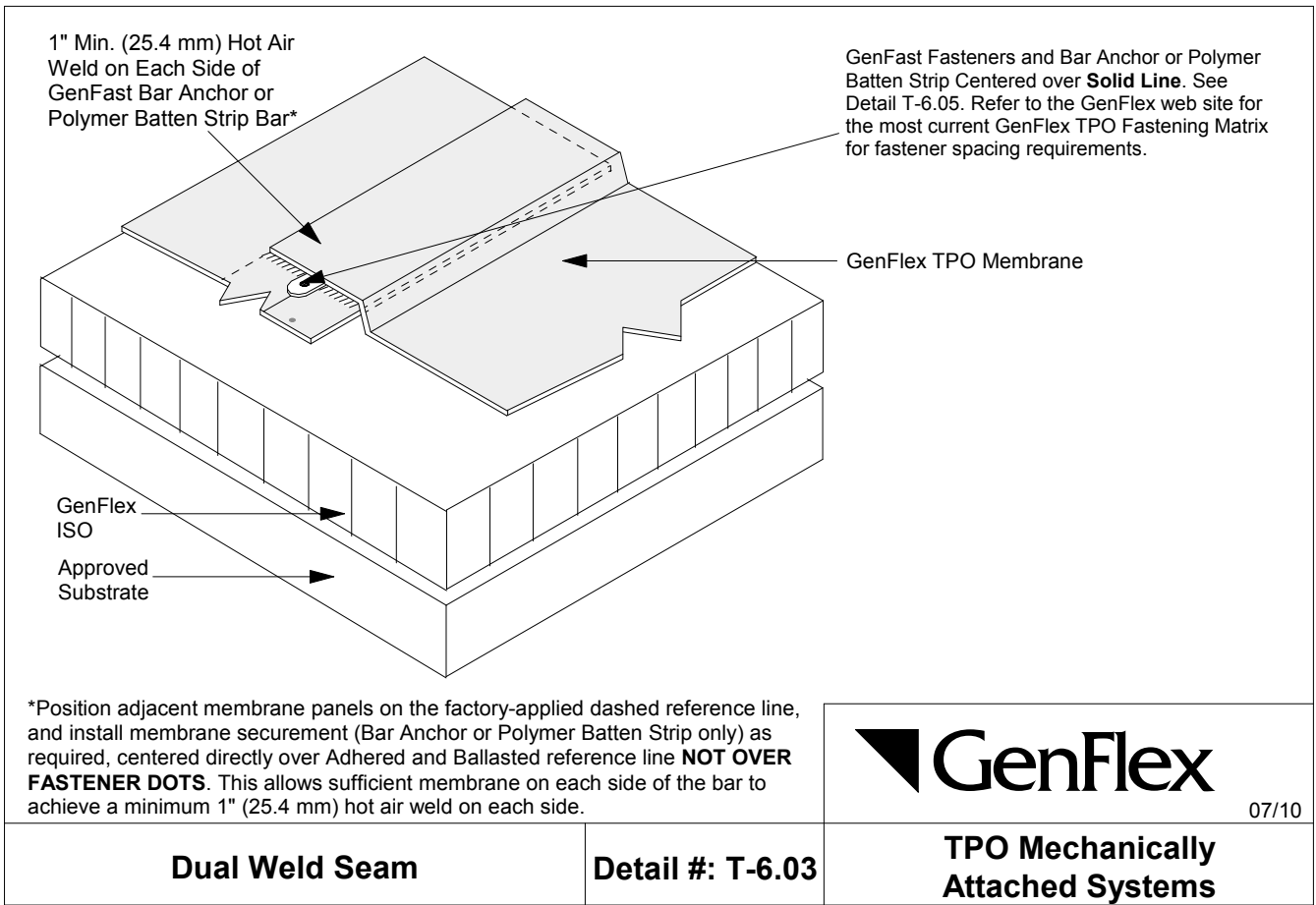

GenFast Bar Anchor Secured with GenFlex Fasteners Spaced According to the Mechanically Attached TPO Code Matrix

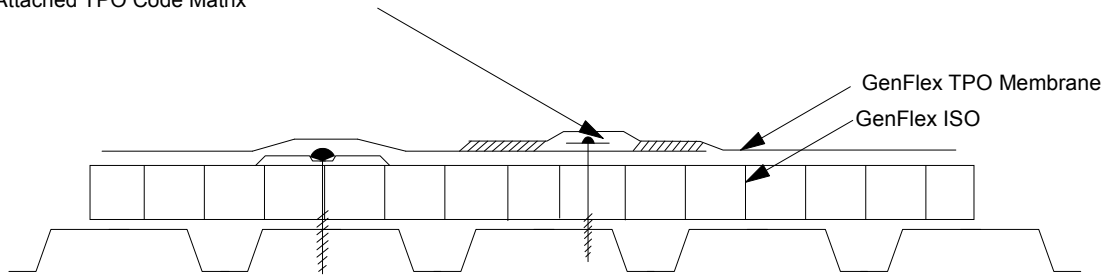

Position insulation and membrane sheets to enable securement into the top flutes on steel decks to ensure positive attachment and to reduce fastener movement. Insulation should be installed with board ends resting on the flute tops.

Refer to Detail T-6.03 for seam specifications.



07/10

**Dual Weld Seam  
Insulation Cross Section**

**Detail #: T-42.02dw**

**TPO Mechanically  
Attached Systems**

GenFast Bar Anchor or Seam Plate Secured with GenFlex Fasteners Spaced According to the Mechanically Attached TPO Code Matrix

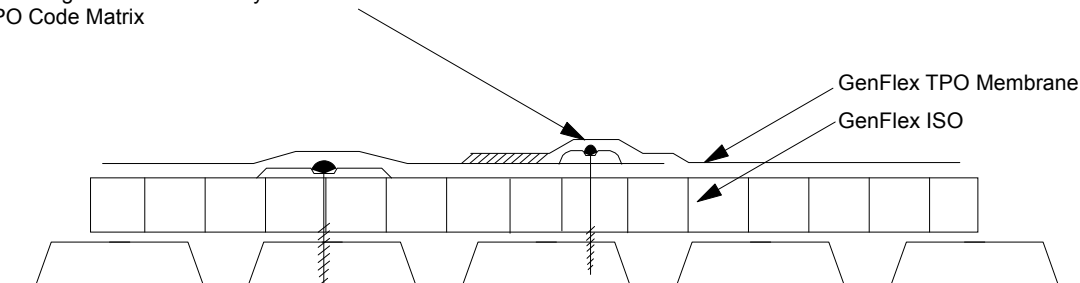

Position insulation and membrane sheets to enable securement into the top flutes on steel decks to ensure positive attachment and to reduce fastener movement. Insulation should be installed with board ends resting on the flute tops.



07/10

**Single Weld Seam  
Insulation Cross Section**

**Detail #: T-42.02sw**

**TPO Mechanically  
Attached Systems**

**For Use on Roofs 0' to 50' (0 m to 15.2 m) Above Ground Level**

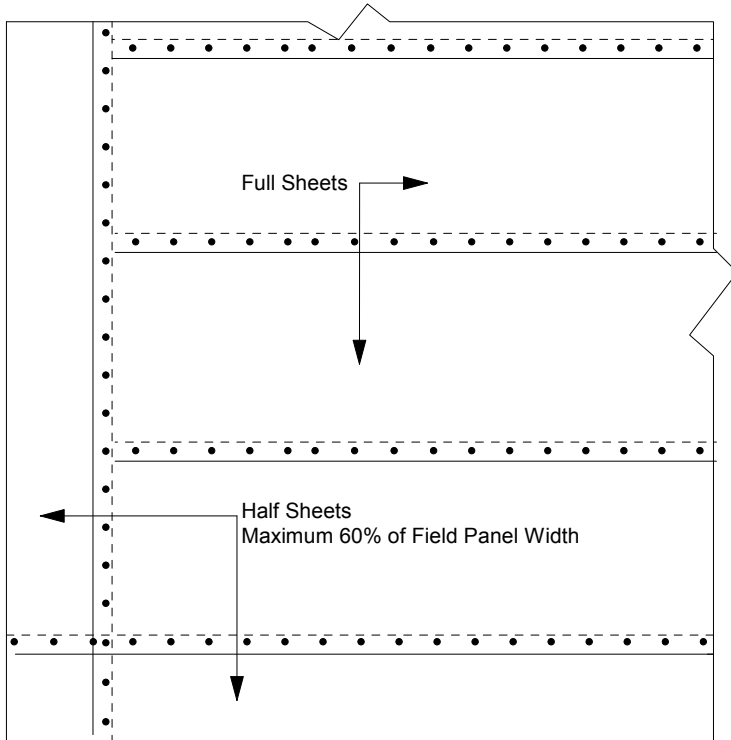

All GenFlex TPO Mechanically Attached Systems require half sheet perimeter securement. A half sheet width of up to 60% of the width of the field panels may be used. Half sheet securement is equal to the membrane securement used in the field of the roof. See the Mechanically Attached TPO Fastener Matrix for fastener and spacing requirements. If the project must meet Factory Mutual criteria, refer to Detail T-42.04-3, and contact Factory Mutual for review.

Half sheets are required at all exterior edges of the roof system and at the upper level edges of transitions in surface height greater than 3' (914.4 mm).

If the building being roofed has any of the following conditions, contact the GenFlex Technical Department for assistance in determining half sheet requirements:

- A) Large wall openings totaling 10% or more of any wall area.
- B) Canopies open below the roof deck.
- C) In the immediate vicinity of large bodies of water or coastline.
- D) Building height in excess of 75' (22.9 m).

For projects requiring a warranty wind speed in excess of 54 mph (86.9 km/h), contact the GenFlex Technical Department for perimeter securement requirements. Additional half sheets and/or fasteners and seem plates may be required.

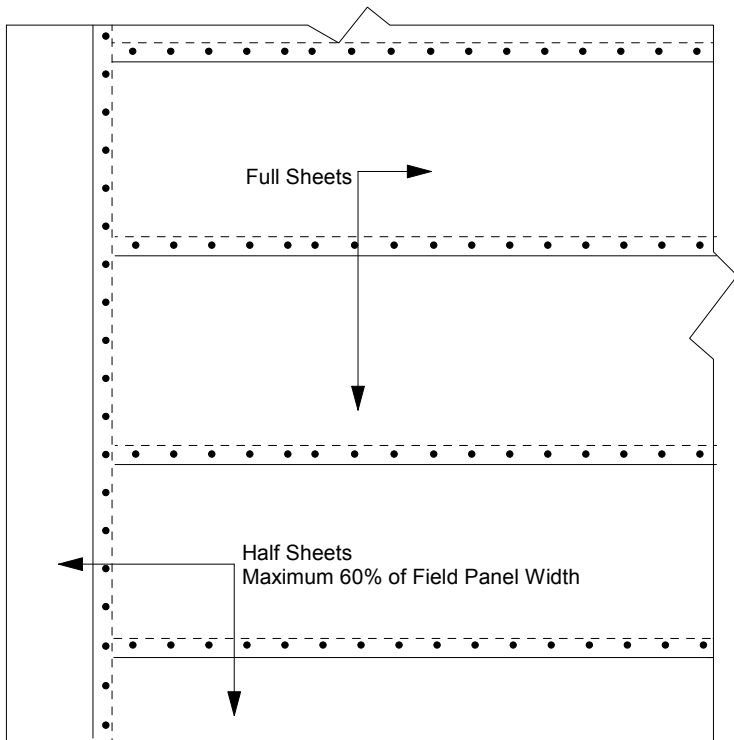

07/10

**Perimeter Securement Layout for Standard Warranty 50' High or Less**

**Detail #: T-42.04-1**

**TPO Mechanically Attached Systems Only**



**For Use on Roofs 50' to 75' (15.2 m to 22.9 m) Above Ground Level**

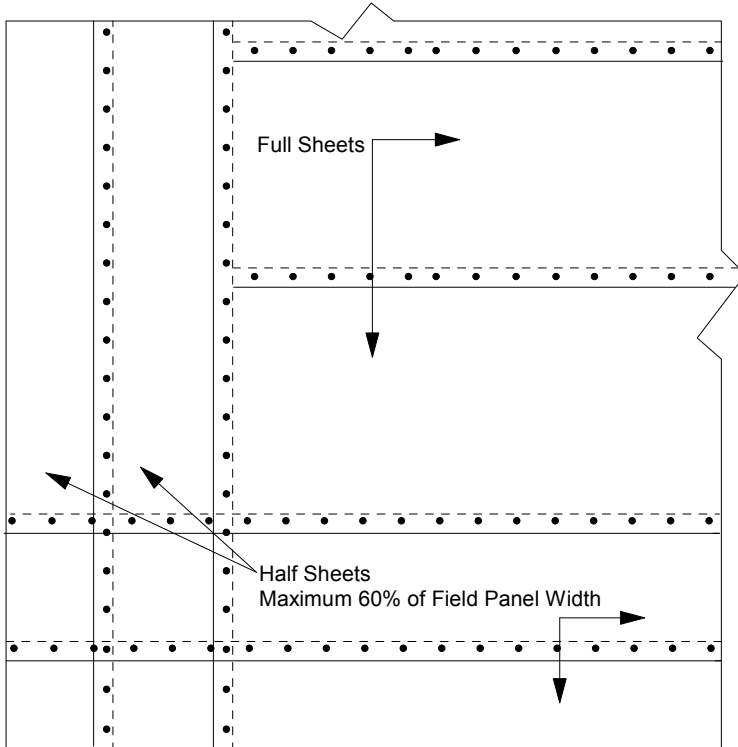

All GenFlex TPO Mechanically Attached Systems require half sheet perimeter securement. A half sheet width of up to 60% of the width of the field panels may be used. Half sheet securement is equal to the membrane securement used in the field of the roof. See the Mechanically Attached TPO Fastening Matrix for fastener and spacing requirements. If the project must meet Factory Mutual criteria, refer to Detail T-42.04-3, and contact Factory Mutual for review.

Half sheets are required at all exterior edges of the roof system and at the upper level edges of transitions in surface height greater than 3' (914.4 mm).

If the building being roofed has any of the following conditions, contact the GenFlex Technical Department for assistance in determining half sheet requirements:

- A) Large wall openings totaling 10% or more of any wall area.
- B) Canopies open below the roof deck.
- C) In the immediate vicinity of large bodies of water or coastline.
- D) Building height in excess of 75' (22.9 m).

For projects requiring a warranty wind speed in excess of 54 mph (86.9 km/h), contact the GenFlex Technical Department for perimeter securement requirements. Additional half sheets and/or fasteners and seam plates may be required.

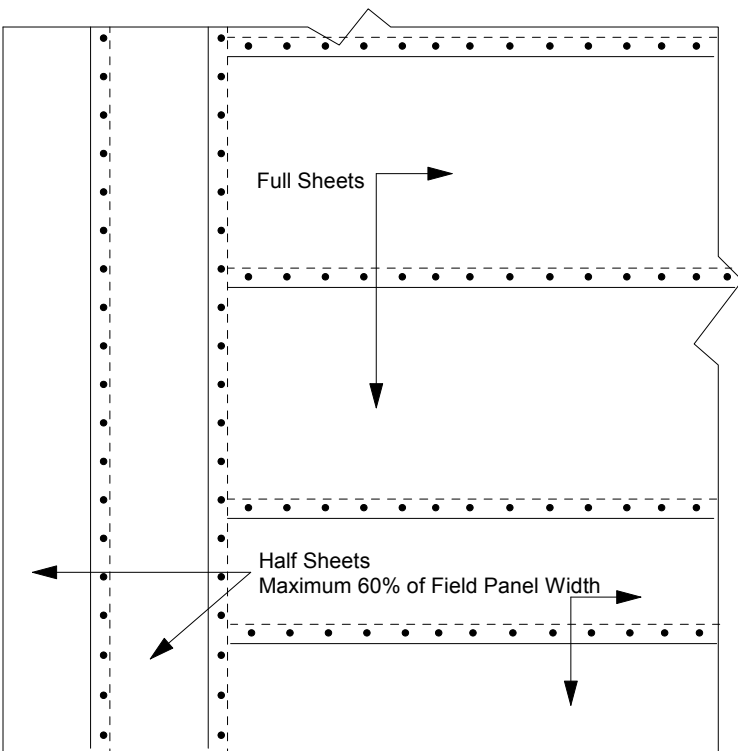

07/10

**Perimeter Securement Layout for Standard Warranty 50' to 75' High**

**Detail #: T-42.04-2**

**TPO Mechanically Attached Systems Only**

## For Use on Roofs Requiring Factory Mutual Rating Compliance

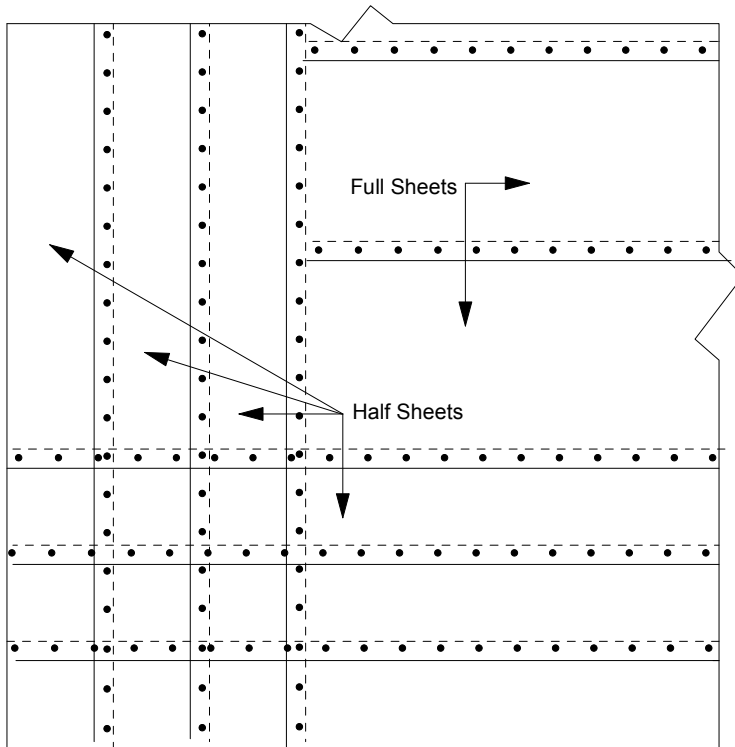

The widths of enhanced perimeter and corner securement areas on a Mechanically Attached TPO roof system are determined by multiplying the building height by 0.4 or multiplying the lesser building dimension by 0.1, whichever is less. The perimeter area must be roofed with half sheets (half sheets up to 60% of the field sheet width are acceptable) that are secured at the same rate as the full width field sheets of membrane. The corner areas must be further enhanced as shown by crisscrossing the half sheets in the corners.

Caution: On installations that must meet Factory Mutual requirements, all fasteners used to enhance the corner areas must penetrate the uppermost layer seam assembly.

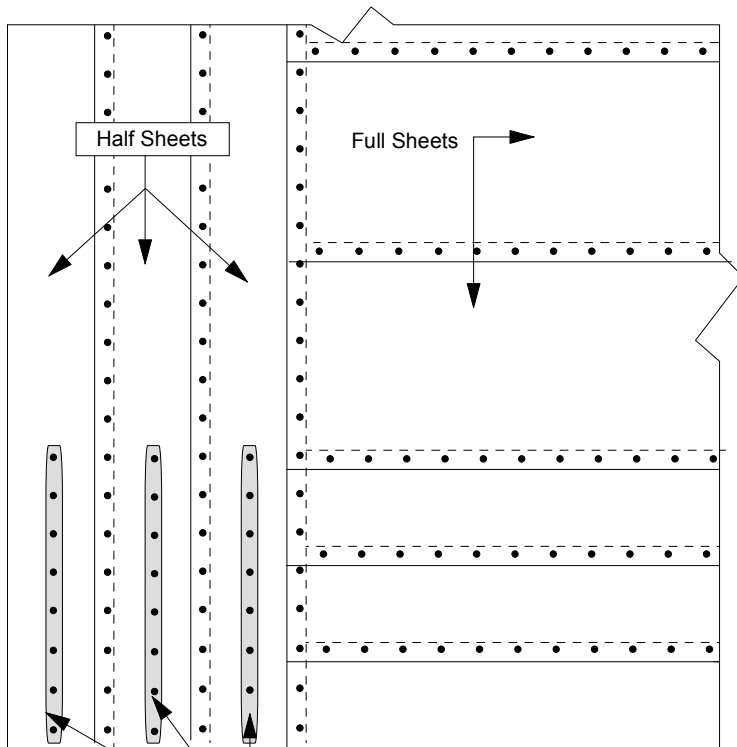

As an option, corner enhancement may be accomplished by installing additional rows of securement through the half sheets and then stripping-in those rows of securement with GenFlex TPO Cover Tape after first applying GenFlex Clear Primer with a Scrub Pad & Handle.

Corner securement must be equal to field securement and reduce the area being secured to 40% maximum of field panel width. For assistance, contact the GenFlex Technical Department.

 **GenFlex**

07/10

**Perimeter Securement Layout for  
Factory Mutual Rated Systems**

**Detail #: T-42.04-3**

**TPO Mechanically Attached  
Systems Only**