

 **DANGER**

ALWAYS TAKE THE FOLLOWING PRECAUTIONS BEFORE ANY SERVICE OR ROUTING MAINTENANCE IS PERFORMED:

- **REMOVE FASTENERS**
- **REMOVE FUEL CELL**
- **REMOVE BATTERY**

REMOVE THE MAGAZINE ASSEMBLY

Loosen and remove knob (part #801124).



Slide the magazine back and away from nose.



REMOVE HANDLE ASSEMBLY (Part 1)

Lift off cap, grill and filter with screw driver.



Loosen four screws using a 5/32" hex key (Part # 7405061).



Lift off cap assembly (Part # 401365).



REMOVE HANDLE ASSEMBLY (Part 1)

Remove Screw at bottom of Handle Assembly
(Part # 7405065).



Remove Cam Bushing.(Part # 401397).

Push Cam Bushing out of Handle from
side where the Screw was removed.

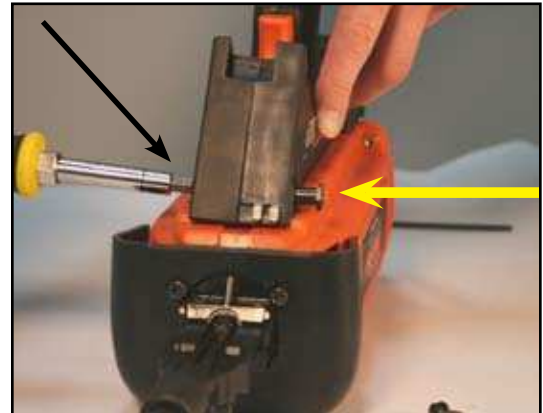

REMOVE MOTOR ASSEMBLY

Pull Handle Assembly away from Motor Assembly until fan clears combustion chamber assembly.

Do not scratch combustion chamber walls with fan blades.

Set Handle Assembly down carefully so that Fan Blades are not damaged and Fan Motor Shaft is not bent.

When removing handle from housing, be sure not to bend fan blades.



 **CAUTION**

Be sure leads and connectors are positioned so that leads are not pinched when installing cap.

 **WARNING**

DO NOT operate tool until all screws are tightened.

 **DANGER**

NEVER attempt to operate tool without cap assembly securely fastened. Cap assembly secures cylinder head to combustion chamber.

Operating TrakFast with cap assembly off or loose will cause burning fuel to escape through top of tool, causing burns and damage to tool.

Motor/Cylinder Head Assembly

Torque Head Switch to 5-10 in-lbs.

Torque Spark Plug to 20-25 in-lbs.

Install Stem Adapter as illustrated.

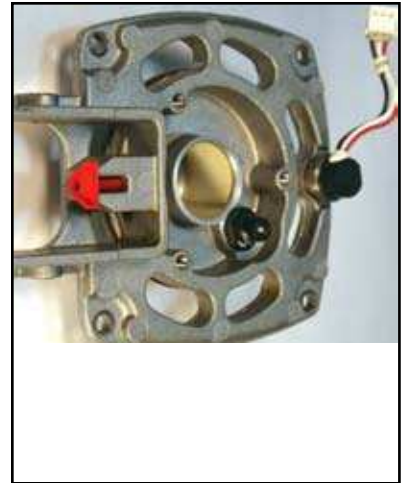

Notice the difference between one end of the Sleeve to the other. One side of the sleeve has a rib. The other side does not. The ribs should be to the inside and should touch the fan motor.

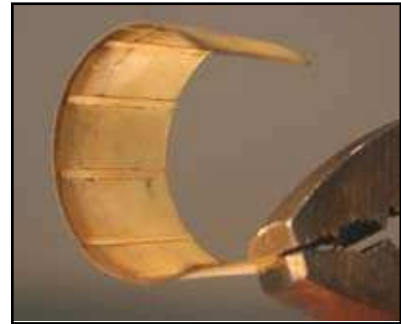

****CRITICAL****

Install the Motor Sleeve as illustrated. Pay careful attention to the orientation of the “split” which is pointing at the Spark Plug and how the ends of the Motor Sleeve face each other. This process determines how well the motor shaft will be centered after the motor is inserted.



Motor/Cylinder Head Assembly (cont'd)

Apply a small amount of oil or lubricant to the inside of the bore where the Fan Motor is positioned.

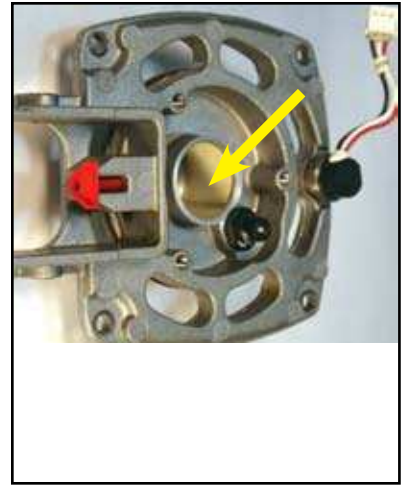

Insert Motor Assembly as illustrated.

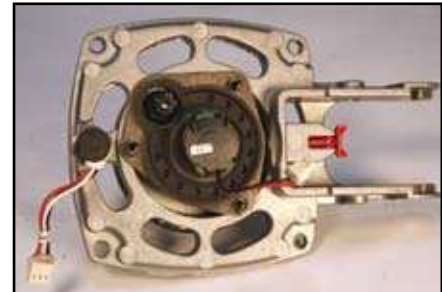

The Motor Sleeve orientation will determine how well the spacing will be around the shaft. Make sure that it is equally spaced all the way around.

SOMETIMES you may have to adjust the Motor Sleeve clockwise or counterclockwise to help center the shaft.



Motor/Cylinder Head Assembly (cont'd)

Make sure the “flat” side of the shaft is where the Set Screw on the Fan Blade will be tightened.

Position the Fan Blade approximately .120” away from the bottom of the cylinder head. Feeler Gages or an 1/8” drill bit works well as a spacer.

Carefully place the Fan Blade until it is flat and leveled over the Fan Blade Spacer.

Tighten Set Screw no more than 8 to 10 in-lbs of torque.



CYLINDER HEAD ASSEMBLY

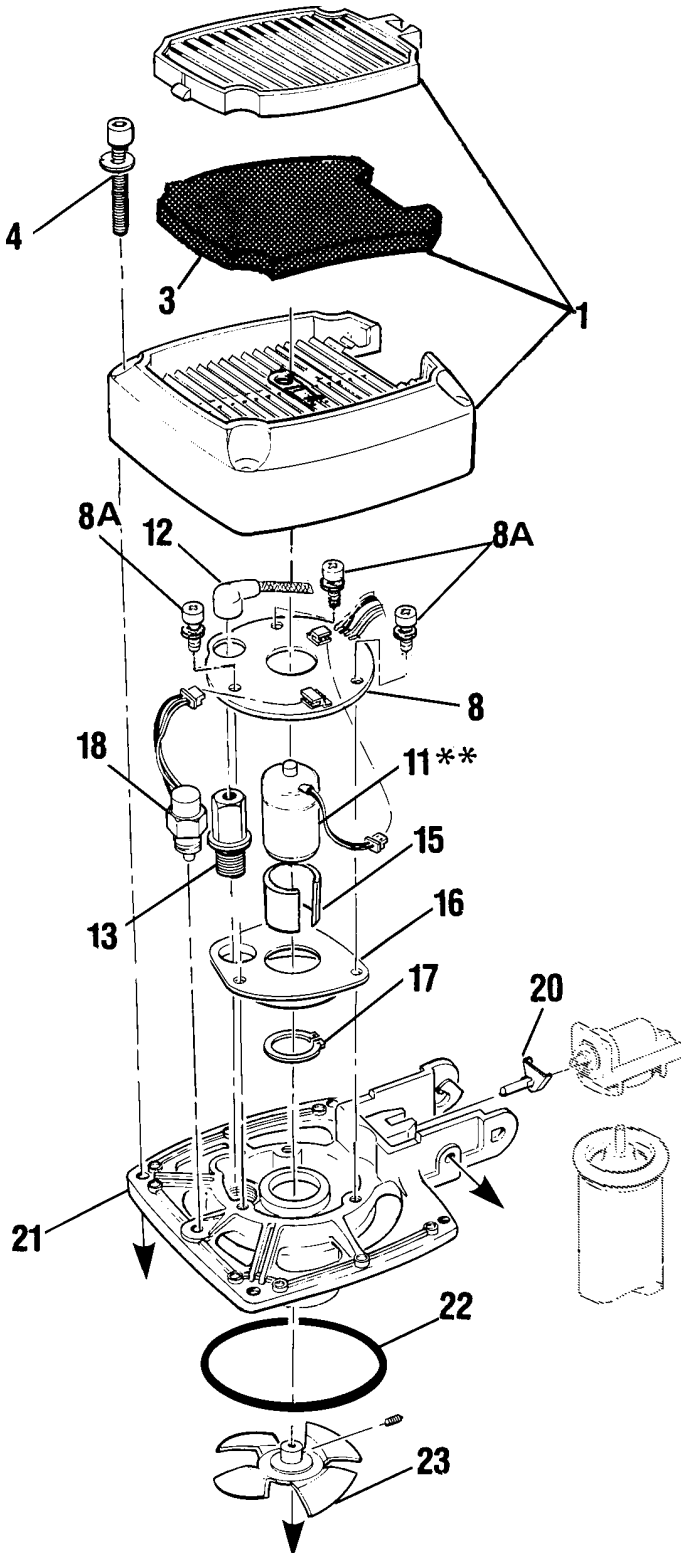

KEY	PART NO.	DESCRIPTION
1	401365	Cap, grill & filter assembly
3	7505018	Foam filter only
4	901065A	Screw kit, #10-24 x 1-1/4" Sems (pkg. 4)
8	900271	P.C board assembly
8A	7405090	P.C board screw & washer, #8-32 x 1/2" (pkg. 3)
11	900525A	Fan motor kit**
12	7505166	MSU spark wire & boot only
12A	404397	Spark plug boot only (for 401341 plug)
13	7505164	Black spark plug (with O-Ring) (for tools after serial no. 39809144)
13A	401341	Red spark plug (with O-Ring)
15	401356	Motor sleeve
16	900470	Motor mount
17	401355	Motor retaining ring
18	404601	Head switch assembly
20	401340	Red stem adaptor
21	401336	Cylinder head
22	403992	O-Ring (cylinder head)
23	403167	Fan blade (with set screw)

Note: It is important to use all kit parts when replacing the fan motor. Failure to do so will greatly reduce the life of the motor.

** The Fan Motor Kit includes: Fan Motor, Motor Mount, Motor Sleeve, Snap Ring and Fan Blade.

Handle Assembly (part 2)

Remove Trigger Cam (part #401396).

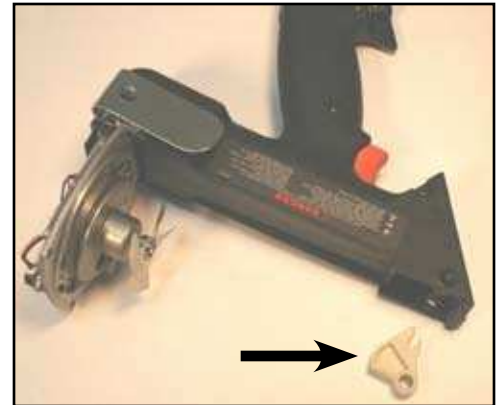

Remove Belt Hook and screw.
(screw, part #7405065)
(Belt Hook, part #401495)



Remove (3) screws (part #7405067).

Remove (1) screw (part #7405066).

Lift off Handle half.



Remove Actuator Assembly (part #401400A).



Handle Assembly - Part 2 (cont'd)

Remove Trigger and Spring from Handle.
(Trigger, part #401394A)
(Spring, part #401395)

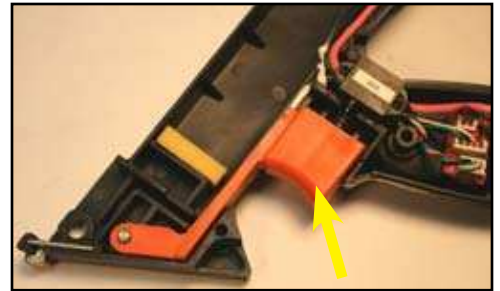

Remove Trigger Switch with screw driver.
Undo the two screws and lift out.
Unplug from the Spark Unit.

(Trigger Switch, part #404990)
(Trigger screws, part #7405091)

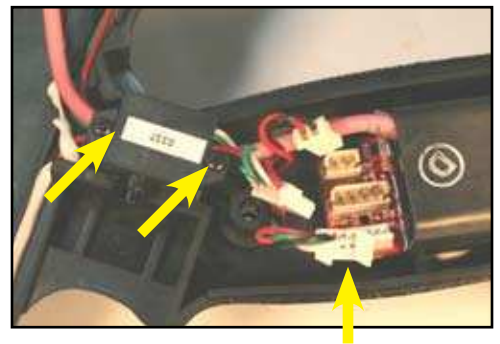

Using a Phillips screw driver, remove screw. This will disconnect
the Handle from the Cylinder Head (part #7405065).



Lift out wire Cover Plate (part #900012).



Handle Assembly - Part 2 (cont'd)

Lift up Spark Plug wire and remove from Handle half (part #7505166).

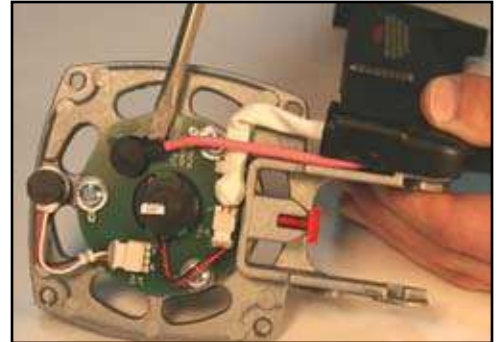

Unplug Spark Wires from Spark Unit.

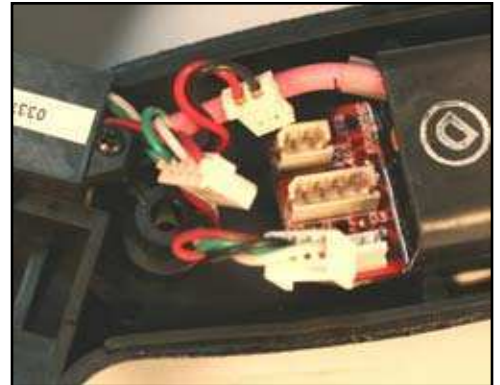

Lift up with screw driver to remove Spark Unit (part #7405163).

Note: MSU Spark Units are held in place with silicone.



Disconnect Head Switch from P.C. Board (part #404601) and unscrew Head Switch.

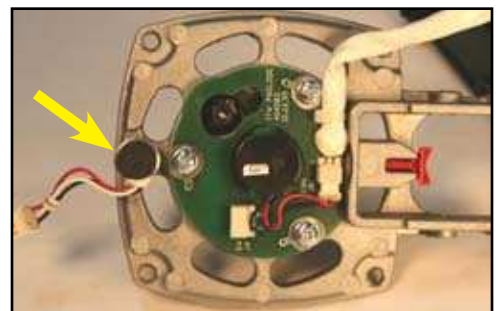

Handle Assembly - Part 2 (cont'd)

Remove Fan Blade Set Screw (requires #T-7).
(Fan Blade part #403167 with screw)



With Phillips screw driver remove (3) screws (part #7405090)
holding P.C. Board. Unplug Fan Connector.

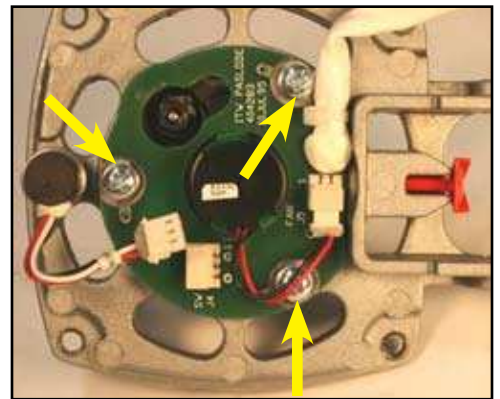

Pull out red Stem Adapter (part #401340).

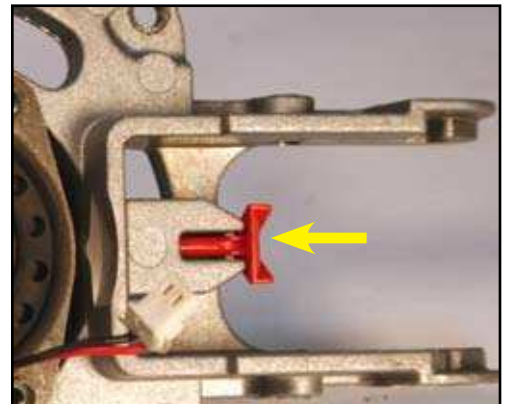

Lift up O-Ring and remove (part #403992).
Inspect O-Ring. Replace is any damage is noted.



Handle Assembly - Part 2 (cont'd)

Remove Spark Plug (part #7505164).

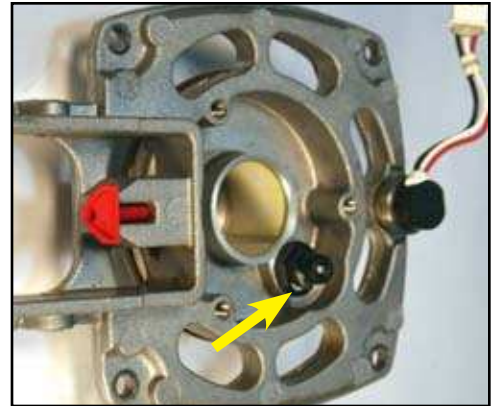

Fan Motor Kit (part #900525A).

See inserts for Motor/Cylinder Assembly.

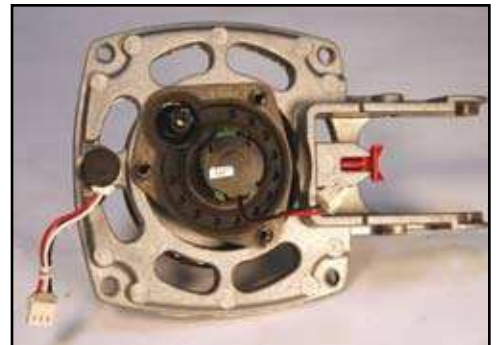

Handle Assembly

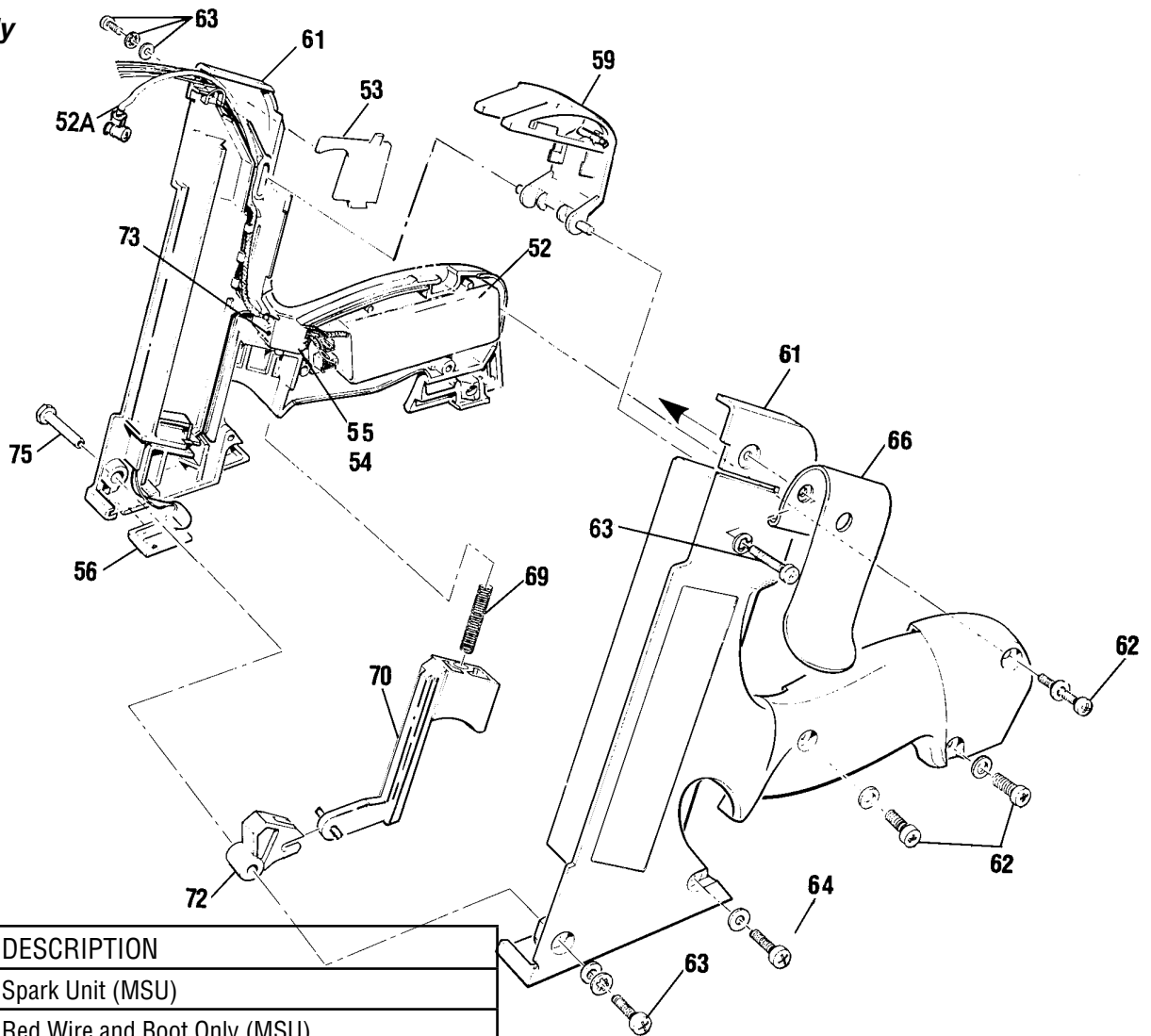

KEY	PART NO.	DESCRIPTION
52	7405163	Spark Unit (MSU)
52A	7505166	Red Wire and Boot Only (MSU) (For tools after serial no. 398091440)
53	900012	Wire Cover Plate
54	404619	Insulator (under Trigger Switch)
55	404490	Trigger Switch
56	403999	Handle Contact Board
59	401400A	Actuator Assembly
61	7405148	Left & Right Side Handle Halves
62	7405067	Screws & washers, #6-32 x 1" (pkg. 3)
63	401408	Screw & washer, #10-32 x 9/16"
64	401406	Screw & washer, #6-32 x 1-1/2"
66	401495	Belt Hook
69	401395	Trigger Spring
70	401394A	Trigger Assembly
72	401396	Trigger Cam
73	7405091	Trigger Screws, #2 x 5/8" (pkg. 2)
75	401397	Cam Bushing
	401450	Fuel Cell Pad (not shown)

Magazine Assembly

Remove (2) screws holding Foot (part #7505146).



Remove Foot (part #801113).

Pull off Magazine.



Remove Lower Rail (part #801110).

Pull and slide out rear of Magazine.



Remove (3) screws from Magazine (part #7405070).

Remove (1) screw (part #7405071).



Magazine Assembly (cont'd)

Remove (2) screws from Shear Block (part #7405147).



Remove Magazine halves (part #7405149).



Remove Upper Rail (part #801112).

Inspect Upper Rail for heavy burrs.



Remove Cover Plate (part #7506006).



Magazine Assembly (cont'd)

Remove Battery Contact (part #7505017).

Inspect Battery Contact for bent or broken terminals. Replace Contact Assembly if these conditions exist.



Remove Shear Block.

Take out (2) screws (part #7405147).

Shear Block (part #7405145).



Remove Battery Clip screw (part #401423).



Remove Battery Clip (part #401422).



Magazine Assembly (cont'd)

Remove Carrier Assembly from Magazine half.

 **CAUTION**

Hold Carrier firmly and slide forward to front of Magazine towards the post and lift Constant Force Spring off post (part #7405168).



Remove Lockout Bracket screw (part #801122).

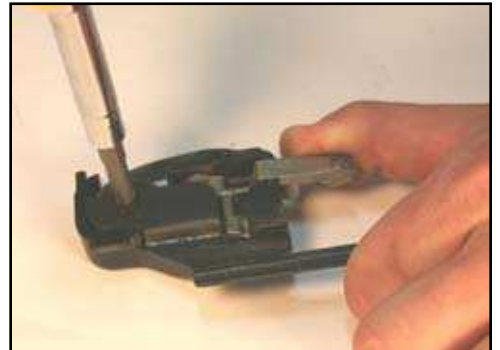

Remove Lockout Bracket (part #801106).



Remove Spring and Hub (part #7405169).



Magazine Assembly (cont'd)

Remove pin from Spring Carrier/Follower Assembly (part #7405168).

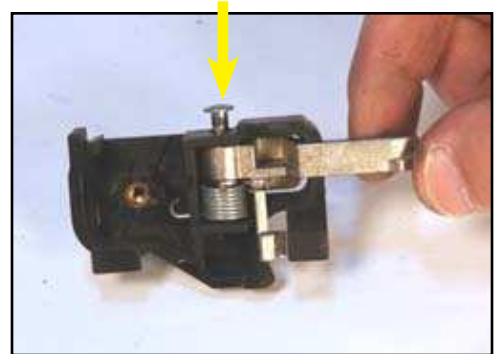

Remove spring from Carrier (part #7405168).

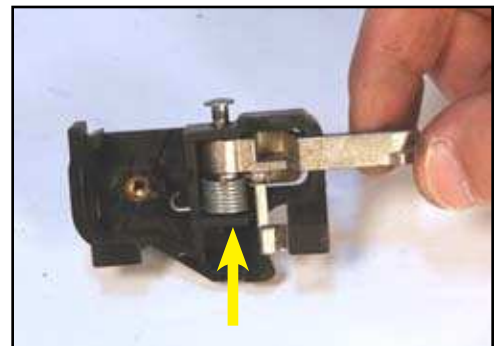

Magazine Assembly

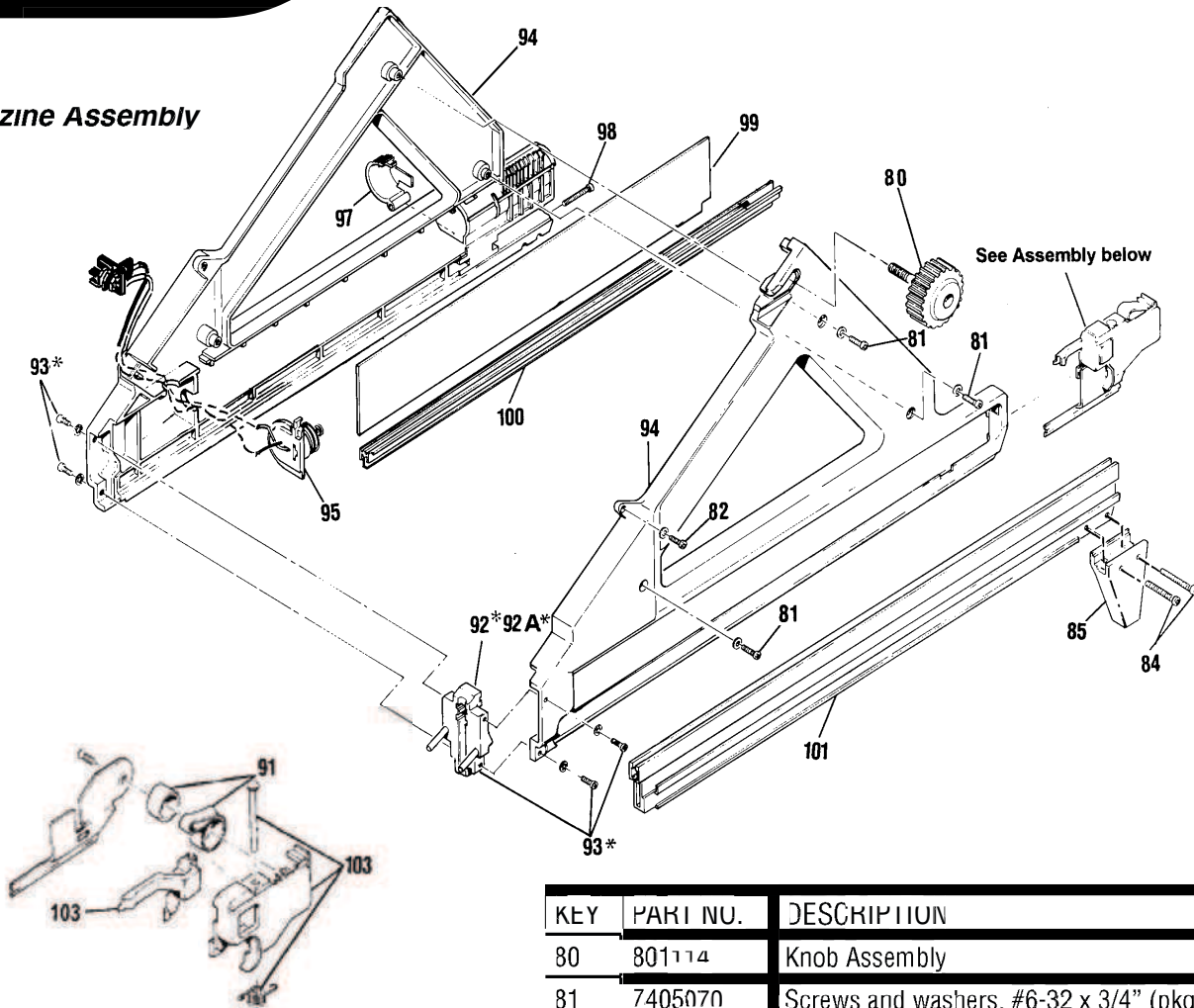

KEY	PART NO.	DESCRIPTION
80	801114	Knob Assembly
81	7405070	Screws and washers, #6-32 x 3/4" (pkg. 3)
82	7405071	Screws and washers, #6-32 x 1/2" (pkg. 3)
84	7405146	Food screws, #6 x 7/7" (pkg. 2)
85	801113	Magazine foot
91	7405169	Constant force spring with hut
92*	801126	Shear block (for Telescoping Nosepiece tools)
92A	801118	Shear block kit with screws & washers (for Original Nosepiece tool) Pre August 2001
93	7405147	Shear block screws & washers only (fits both type shear blocks)
94	7405149	Left & right magazine halves (with battery clip)
95	7505017	Battery contact assembly
97	401477	Battery clip
98	401423	Battery clip screw, #6-32 x 1-1/4"
99	7506006	Cover plate
100	801112	Upper rail
101	801110	Lower rail
103	7405168	Carrier/Follower assembly
	7405177	Follower/Lockout assembly complete

*screws use Loctite 242 (Blue)

Housing Assembly

Remove (3) screws (part #7405060).

Lift off Dust Shield (part #7505013).

Lift off Housing (part #7505148).

Lift off Nosepiece Assembly (part #801130A).



Housing Assembly (cont'd)

Remove Piston Stop Retaining Ring (part #401328), using Snap Ring pliers (part #401333).

Make sure when you reassemble that Retaining Ring ends are not positioned in the vertical notches in the Sleeve.



Slide Piston out of Mid-check Assembly (part #7502000).



Lift off Air Dam (part #401313).

Check position of Air Dam when reassembling.

Note notches in the Air Dam.



Remove (4) Cage screws (part #092769).



Housing Assembly (cont'd)

Slide off Cage and Spring.

(part #7405144 only comes as an assembly)

(Spring, part #401488)



Lift out Mid-check Retaining Ring (part #401322).

Remove with Snap Ring Pliers (part #401333).

Remove 2 Wave Washers and 1 Seal Washer (part #7405056).

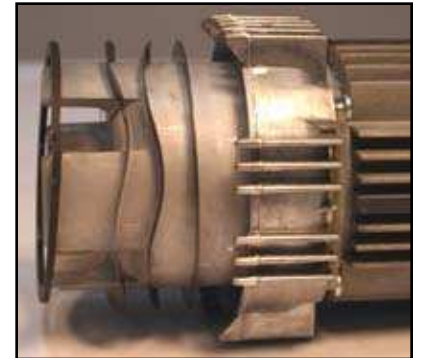

Remove Bumper (part #7505109) using Bumper Removal Tool.



Housing Assembly (cont'd)

Lift off O-Ring (part #404482).



Lift off Piston Rings (part #7405055).

Always make sure the Piston Ring end gaps are opposite each other.



Nose Assembly

Remove (2) screws (part #7405059).

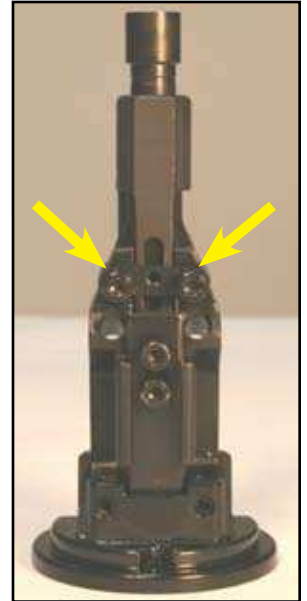

Lift off Stop Plate (part #801127).



Lift off Lock-out Probe (part #801128).

Lift off Work Contact Element (part #801129).

Inspect Work Contact Element for burring or damage. Replace if burring or damage is noted.



Nose Assembly (cont'd)

Remove (2) screws (part #7405059).



Lift off Guide Block (part #801131).

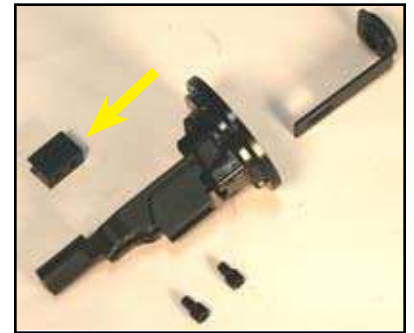

Slide out Upper Probe (part #801132).

Inspect rubber Grommet for damage. Replace Upper Probe if grommet is damaged.

