





















FULL LINE

-  **MAGNA-LOC**
-  **SEAM-LOC 24**
-  **SNAP-LOC 24**
-  **VERTICAL SEAM**
-  **PRO-LOC I**
-  **PRO-LOC II**
-  **PRO-LOC III**
-  **MINI-BATTEN**
-  **MAXI-BATTEN**
-  **IMAGE II**
-  **SOFFIT PANEL**
-  **STILE**
-  **IC72-PANEL**
-  **R-PANEL**
-  **U-PANEL**
-  **SPAN-LINE 36**
-  **SPAN-LINE 36A**
-  **V-LINE 32**
-  **PRO-PANEL II**
-  **CLASSIC RIB**
-  **5V CRIMP**

metal sales
manufacturing corporation



Corporate Office
(812) 246-1935
www.mtlsales.com

SECONDARY FRAMING PURLIN AND GIRT ATTACHMENT

The drawing below represents girts attached flush with the framing utilizing a clip for attachment to the column. Purlins are shown with typical lap condition directly bolted to the beam.

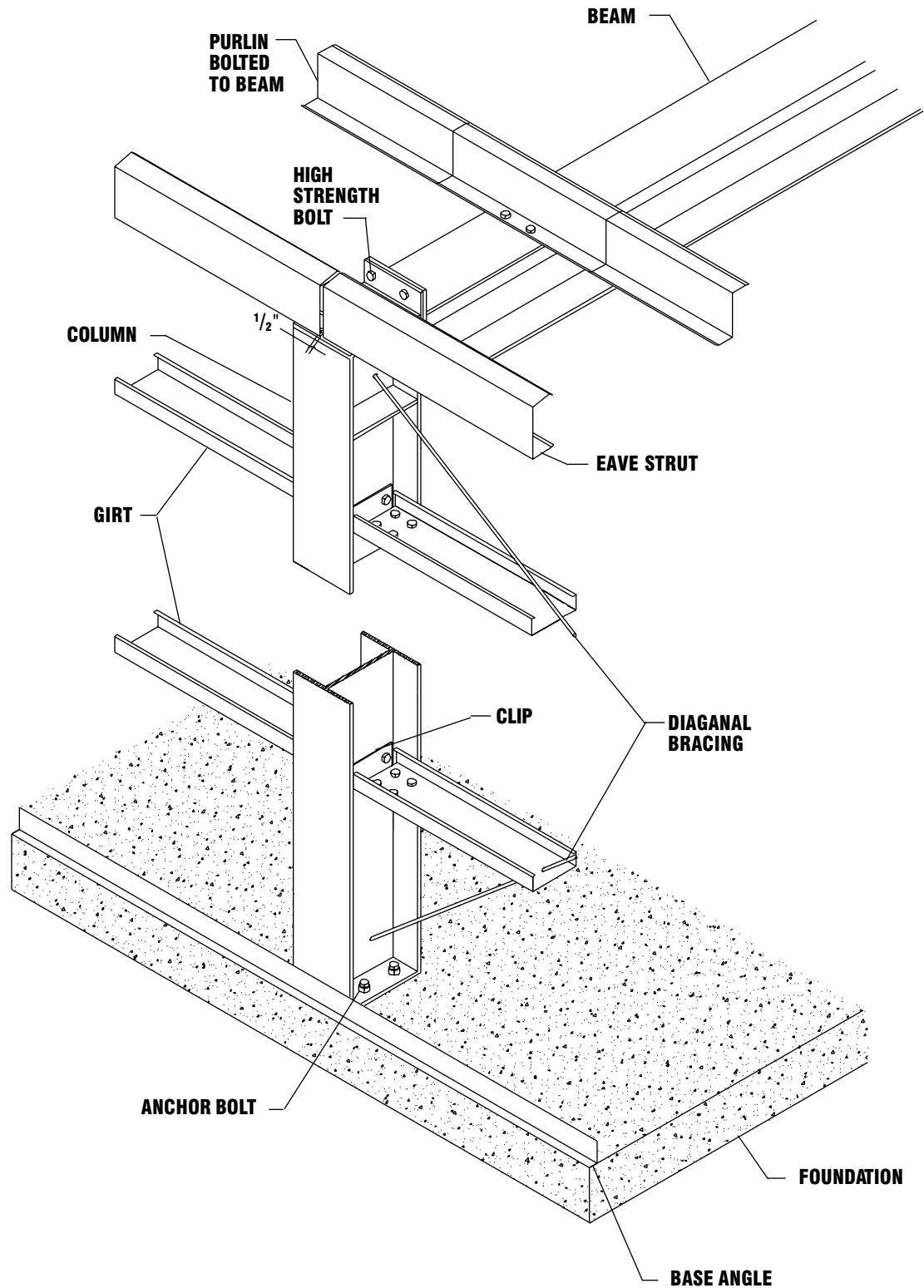

SECONDARY FRAMING PURLIN AND GIRT ATTACHMENT (CONT.)

The drawing below represents girts outside the column attached with bolts direct to the column. Purlins are shown with typical lap condition bolted to the beam with a clip.

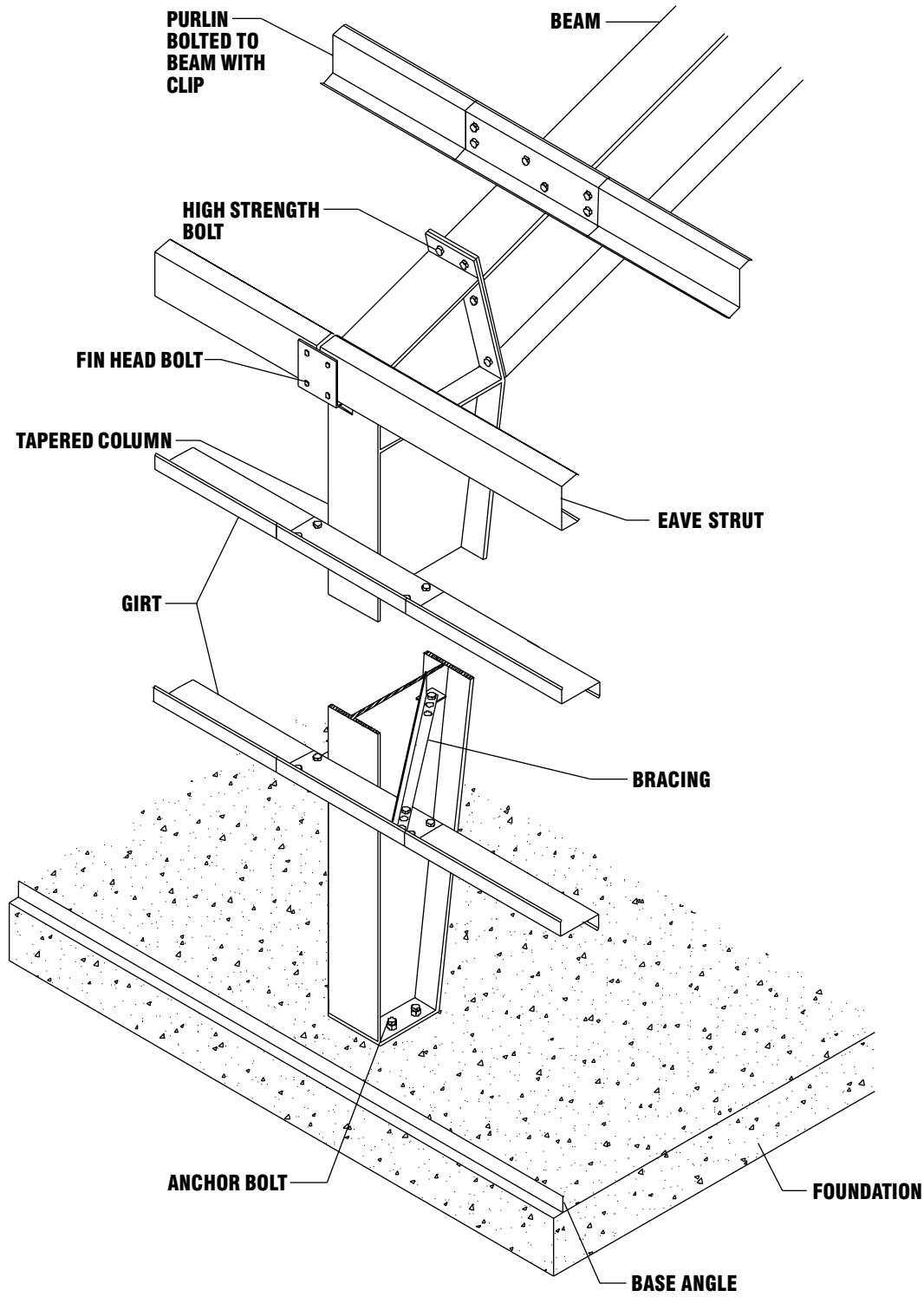

SECONDARY FRAMING PURLIN AND GIRT INFORMATION