



# Nichiha Trim & Accessories

- 3.1 NichiTrim™ Fiber Cement Trim
- 3.2 Nichiha Pre-Manufactured Mitered Corners
- 3.3 Nichiha Metal Trim
- 3.4 Starter Track
- 3.5 Panel Clips
- 3.6 Corner Clips
- 3.7 KuraStone Clips
- 3.8 Short Joint Clips
- 3.9 Long Joint Clips
- 3.10 Single Flange Sealant Backer
- 3.11 Double Flange Sealant Backer
- 3.12 1/4" Spacer
- 3.13 1/2" Spacer

**Nichiha offers trim and accessories that complement our Brick, Stone & Block Panels and NichiProducts™**



### 3.1 NichiTrim™

- ◆ For use with NichiProducts™ and all panel products.
- ◆ Fiber cement trim boards from Nichiha will not rot, crack or split and are insect and fungus resistant.
- ◆ Factory primed and sealed, NichiTrim comes in smooth and cedar texture.
- ◆ Widths:
  - ◆ 3-1/2",
  - ◆ 5-1/2",
  - ◆ 7-1/4",
  - ◆ 7-1/2",
  - ◆ 9-1/4",
  - ◆ 11-1/4" and
  - ◆ 11-1/2"
- ◆ Lengths: 10' and 12'
- ◆ Thicknesses:
  - ◆ 7/16",
  - ◆ 3/4" and
  - ◆ 1"

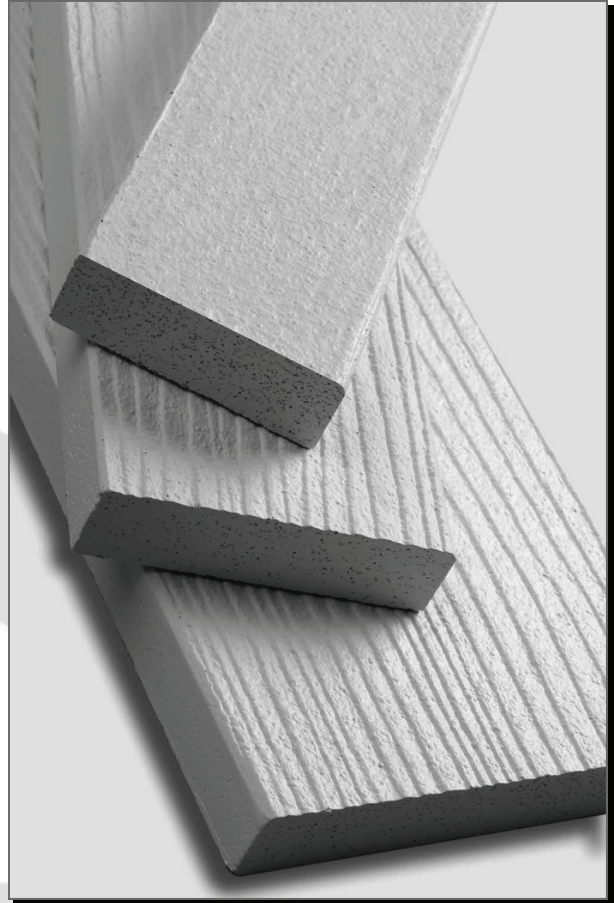

NICHIHA  
fiber cement

### 3.2 Pre-Manufactured Brick, Stone & Block Mitered Corners

- ◆ Pre-manufactured mitered corners are available for all brick, stone and block panel products. Corners are the same height as the panels.
- ◆ Provides a clean professional corner appearance.
- ◆ Top & bottom edges are ship-lapped.
- ◆ Top edges feature a urethane foam seal.
- ◆ Corner sides are smooth cut and ready for sealant joint.

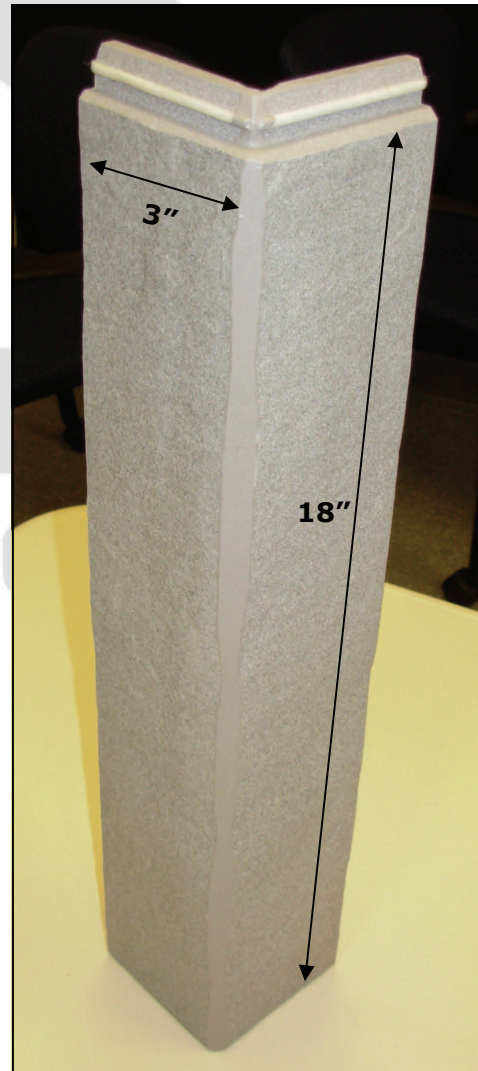
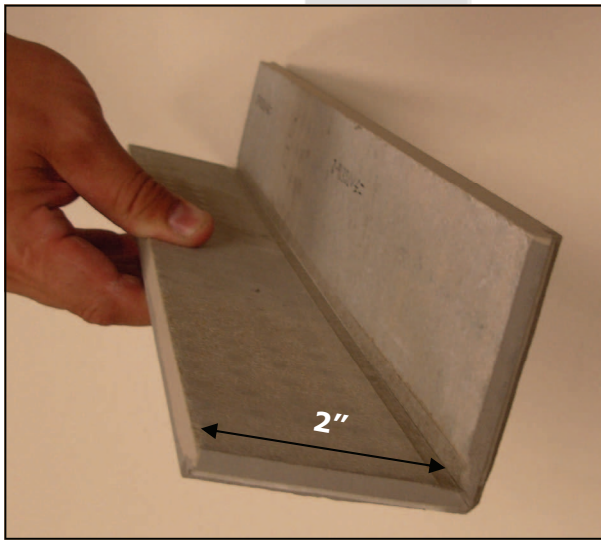

### 3.3 Nichiha Metal Trim

- ◆ Nichiha Metal Trim comes in mill finish, aluminum, beige, bronze and chrome.
- ◆ Applications include: window and door trim, top panel edge, horizontal compression joints, base trim, corner trim, etc.
- ◆ Nichiha Metal Trim is also available in custom colors and configurations. Call Nichiha for details.
- ◆ Standard configurations are:

#### Color / Finish

- 01 = Mill
- 02 = Aluminum
- 03 = Chrome
- 04 = Beige
- 05 = Bronze

#### "X" Corner Trim MT342110-(01-05)

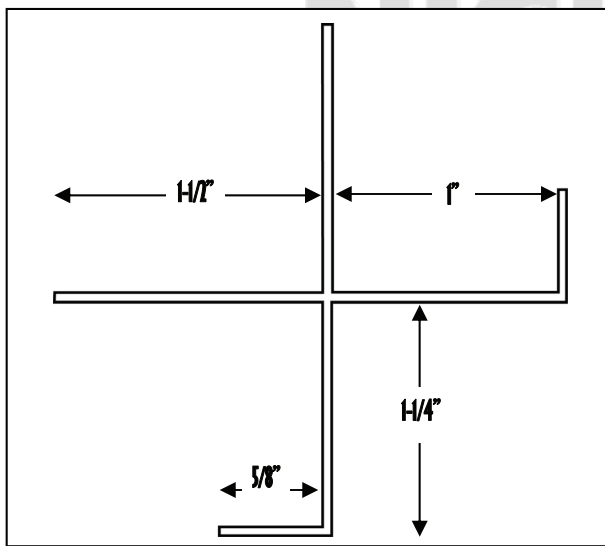

#### "W" Reveal Trim MT342081-(01-05)

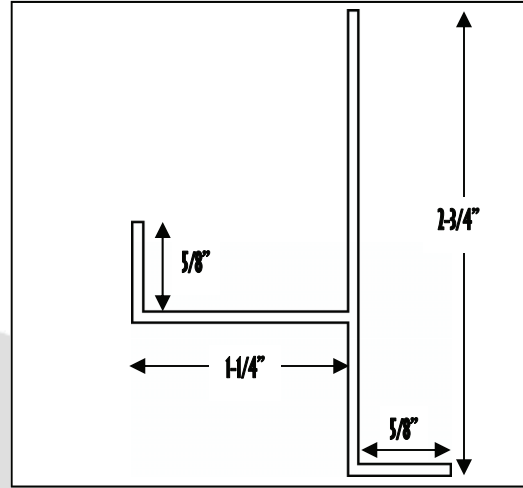

#### "J" Trim MT342080-(01-05)

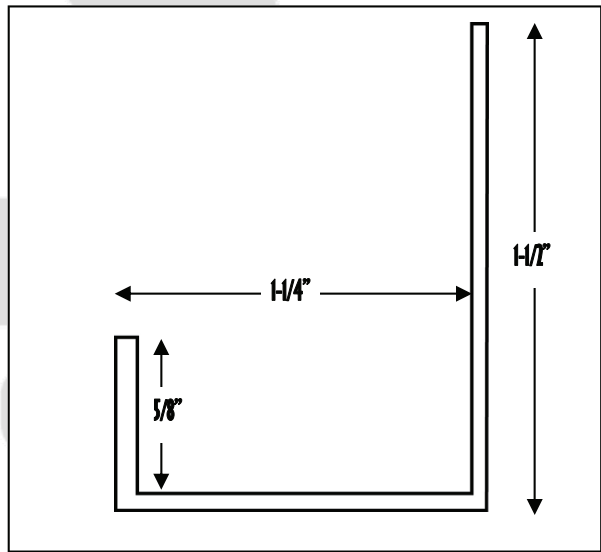

#### "H" Trim MT342169-(01-05)

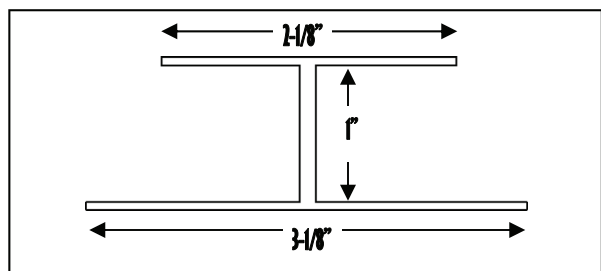

**Corner Key Trim  
MT342079-(01-05)**

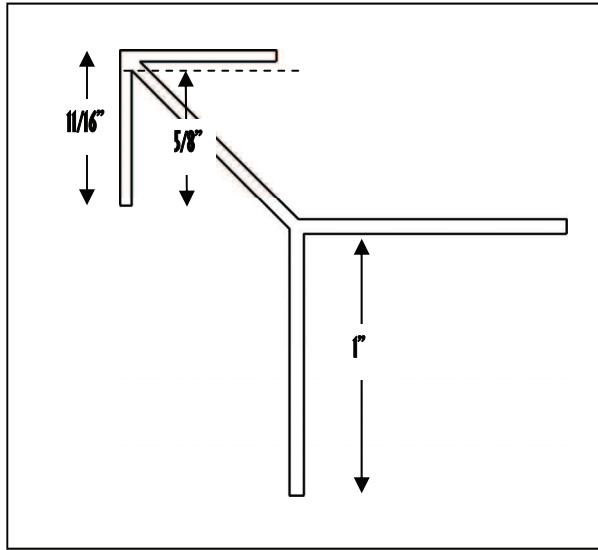

**Start Molding  
(not yet available 11/08)**

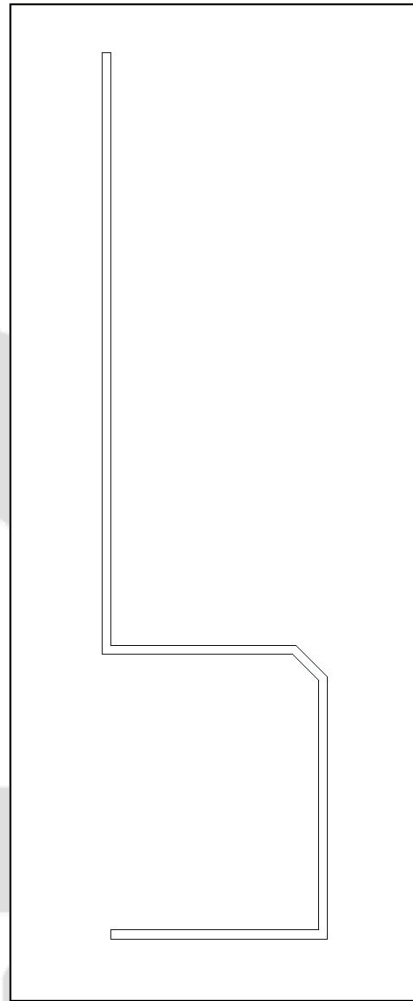

**Radius Corner Trim  
MT342107-(01-05)**

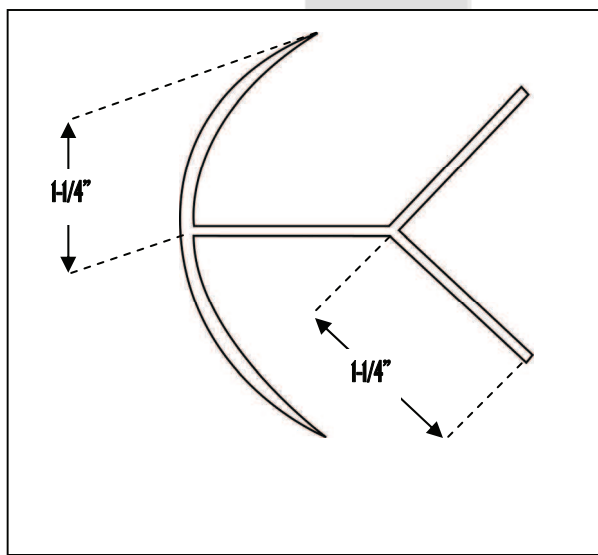

### 3.4 Starter Track

- ◆ For use with Nichiha panel products.
- ◆ Stainless steel track.
- ◆ Used to start panel course.

#### USA & Canada Requirements

- ◆ FA 100: 10' (l), 2-3/4" (h)

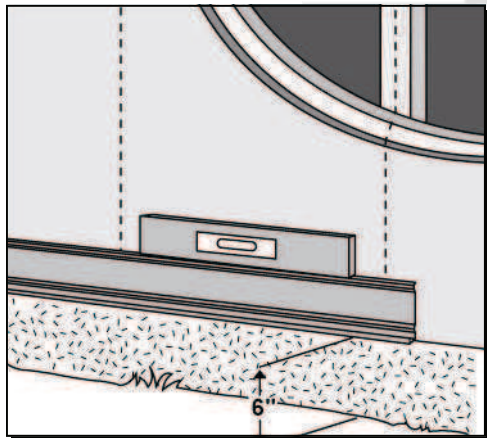
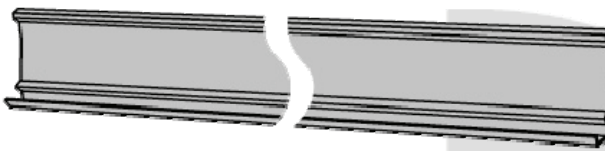

#### KuraStone™ Starter Track

- ◆ FA 100B: 10' (l), 2-3/4" (h)



### 3.5 Panel Clips

- ◆ For use with Nichiha panel products.
- ◆ Stainless steel clip, used on top edges of panels; attached at all framing members.

#### USA Requirements

- ◆ JE 550: 5/8" nominal (16mm actual)
- ◆ JE 650: 3/4", 7/8", 1" nominal (18mm, 21mm, 25mm actual)

#### Canadian Requirements

- ◆ JE 406: 3/4", 7/8", 1" nominal (18mm, 21mm, 25mm actual)
- ◆ JE 710: 5/8" nominal (16mm actual)

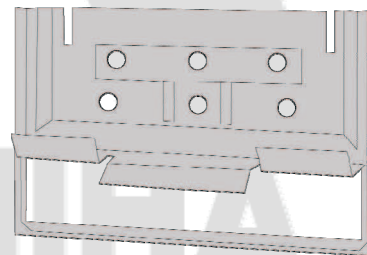

JE 550, JE 650

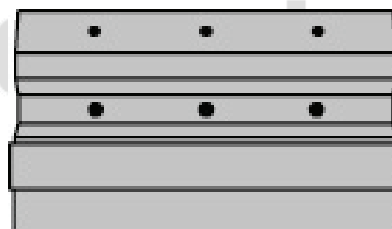

JE 406

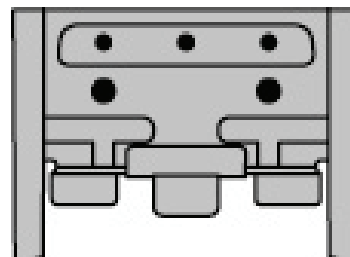

JE 710

### 3.6 Corner Clip

- ◆ For use with Nichiha pre-manufactured mitered corners.
- ◆ JE 550C: used with 5/8" panel products (16mm actual)
- ◆ JE 650C: used with 3/4", 7/8" and 1" panel products (18mm, 21mm, 25mm actual)

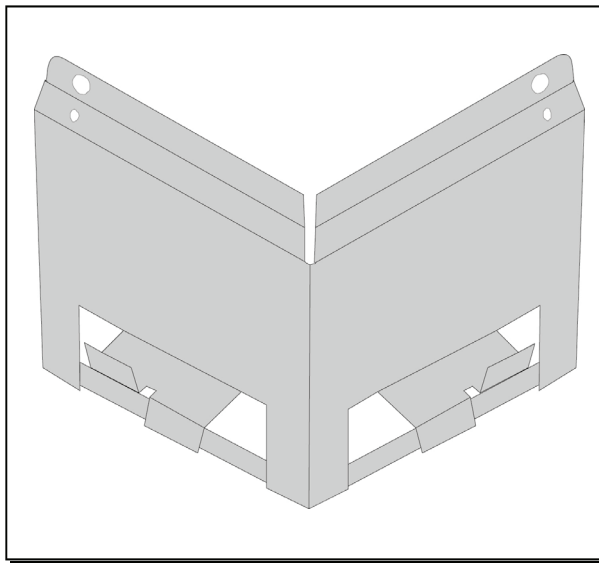

### 3.7 KuraStone™ Clip

- ◆ JE 603: For use with KuraStone™ pieces only.

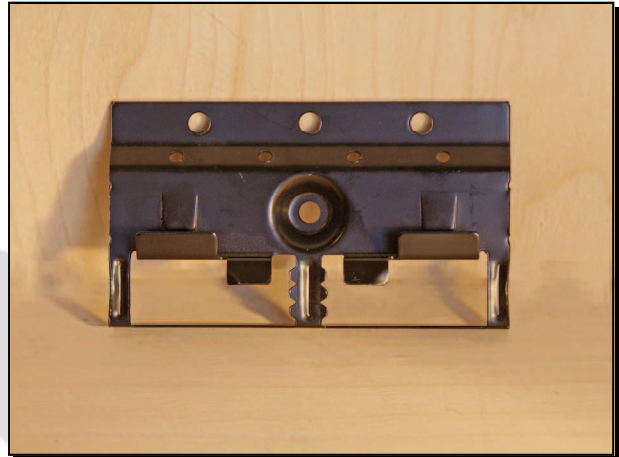

NICHIHA  
fiber cement

### 3.8 Short Joint Clip

- ◆ For use with Nichiha panel products.
- ◆ For use on vertical ship-lapped joints in certain applications.

#### USA Requirements

- ◆ JEJ 505: 5/8" nominal (16mm actual)
- ◆ JEJ 607: 3/4", 7/8" 1" nominal (18mm, 21mm, 25mm actual)

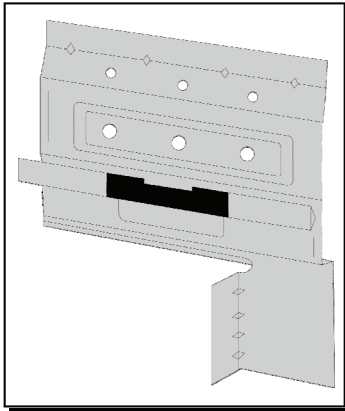

JEJ 505,  
JEJ 607

### 3.9 Long Joint Clip

- ◆ For use with Nichiha panel products.
- ◆ For use on vertical ship-lapped joints in certain applications.

#### USA Requirements

- ◆ JEL 551: 5/8" nominal (16mm actual)
- ◆ JEL 651: 3/4", 7.8" 1" nominal (18mm, 21mm, 25mm actual)

#### Canadian Requirements

- ◆ JEL 552: 5/8" nominal (16mm actual)

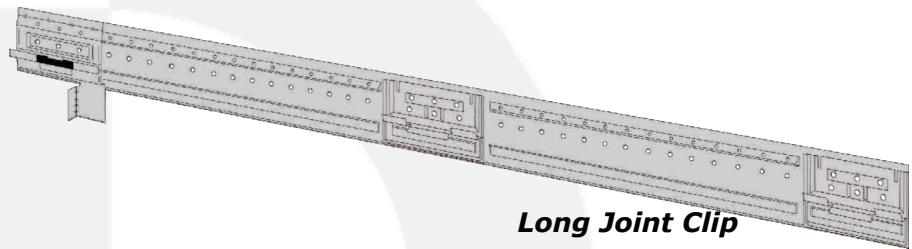

*Long Joint Clip*

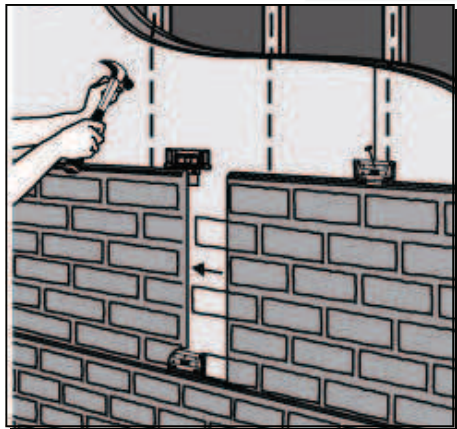



### 3.10 Single Flange Sealant Backer

- ◆ For use with Nichiha panel products.
- ◆ Stainless steel channel.
- ◆ Used for butting up to window trim, doors and inside corners.

#### USA Requirements

- ◆ FHK 1110: 6-1/2' (l)

#### Canadian Requirements

- ◆ FHK 1017: 6-1/2" (l)

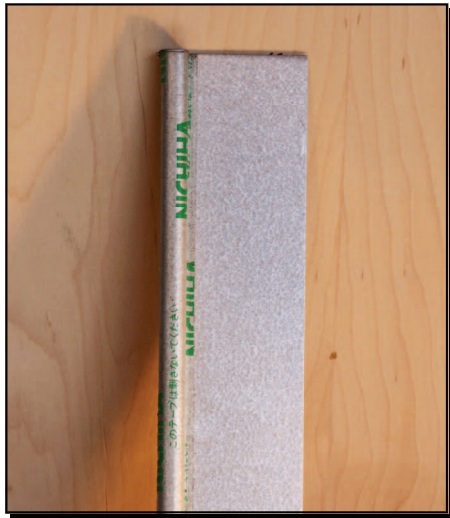

### 3.11 Double Flange Sealant Backer

- ◆ For use with Nichiha panel products.
- ◆ Stainless steel channel.
- ◆ Used with expansion joints and pre-manufactured corners.

#### USA Requirements

- ◆ FHK 1010: 10' (l)

#### Canadian Requirements

- ◆ FHK 1020: 10' (l)



Vertical expansion joint using Nichiha Double Flange Sealant Backer.

### 3.12 1/4" Spacer

- ◆ For use with Nichiha panel products.
- ◆ Green plastic 1/4" (5mm actual) spacer.
- ◆ Used to maintain 1/4" sealant gap and for use behind panels at corners to ensure panel stability and maintain the rain screen.

#### USA & Canada Requirements

- ◆ FS 1005: 48" (l)

### 3.13 3/8" Spacer

- ◆ Optional: For use as a drainable starter with 1/2" Sierra Premium™ Shake & Smooth boards.
- ◆ For use with Nichiha panel products.
- ◆ Green plastic 3/8" (10mm actual) spacer.

#### USA & Canada Requirements

- ◆ FS 1010: 48" (l)

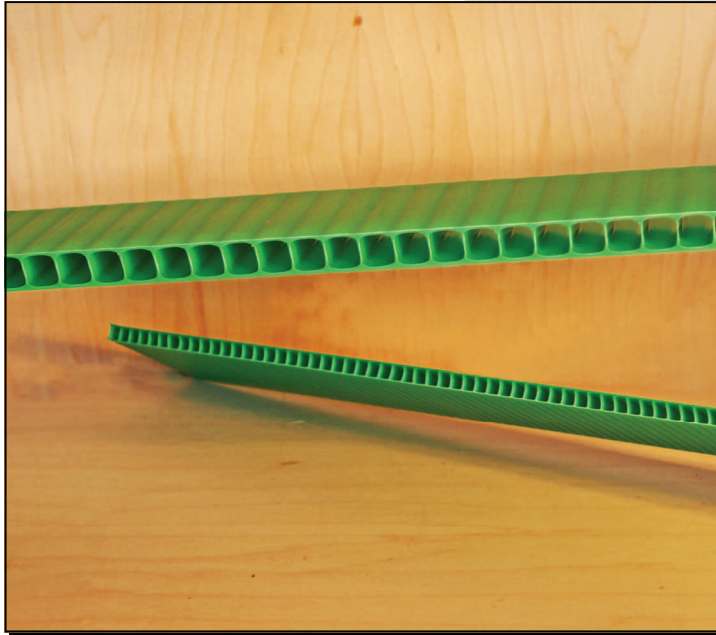

**Section Quiz**

**What Nichiha part is used to “start” a panel course?**

**What accessory would you need at a vertical ship-lapped joint?**

