



industrialized construction

products



USG is committed to a partnership with the Industrialized Construction industry, which includes manufactured housing producers, modular builders, panelizers, and the retailers, suppliers, and professional organizations that work to support them. As part of this effort, USG provides an extensive product offering geared to the needs of assembly-line building. Together, USG's SHEETROCK® MH Brand products (formulated for manufactured housing producers) and its time-honored SHEETROCK® Brand product line are designed to:

- meet the specialized objectives of different types of Industrialized Construction firms;
- address the needs of individual assembly lines; and
- fulfill the unique requirements of the various regions and customers served by Industrialized Construction.





For product specifications, installation instructions and limitations, refer to the literature items listed in this publication.

In addition to products, USG also provides research and development, service, and technical information aimed at supporting Industrialized Construction as it grows into the 21st century and beyond. For more information on USG's commitment to Industrialized Construction, please see publication MH1252 *Architecture in Motion* or visit our web site at www.usg.com.

Table of Contents	Page
Gypsum Board Products	3
Joint Compounds	5
Texture Selector	7
Textures and Texture Paints	9
Bead and Trim	12
Joint Tapes	15
Gypsum Fiber Panels	16
Cement Board	17
Primers	18
Special Sealants	19

Gypsum Board Products

USG manufactures a wide variety of board products designed to satisfy the requirements of different segments of the building industry. Engineered specifically for Manufactured Housing producers, USG's SHEETROCK® MH Brand line of board products provides UL Classification for shear resistance and surface burning characteristics, as well as availability in cut-to-order lengths. Complementing the SHEETROCK MH grouping, USG's regular SHEETROCK® Brand line offers a number of panels formulated to meet additional specialized needs, all available in standard lengths. Additional board products are available on a regional basis; consult your sales representative for further information.

	<p>SHEETROCK® MH Brand Gypsum Panel—TUF-BASE™</p> <p>Features</p> <ul style="list-style-type: none"> – Tapered-edge, shear-rated gypsum panel designed for Manufactured Housing use. – For use as a wall and ceiling substrate where factory-finished drywall is specified. <p>– Meets or exceeds the requirements of ASTM C36. UL Classified as to shear resistance and surface burning characteristics.</p> <p>Size Available in 3/8", 1/2", and 5/8" thicknesses; 4' wide and 54" wide; cut to specified lengths.</p> <p>Resources USG Literature Number MH1175</p>
	<p>SHEETROCK® MH Brand Gypsum Ceiling Board—ULTRA-BASE™</p> <p>Features</p> <ul style="list-style-type: none"> – Lightweight, taper-edged, sag-resistant 1/2" gypsum ceiling board. – For application to ceilings in manufactured homes; also suitable for wall applications. – Lighter weight eases transportation. <p>– Designed for sag-free application parallel to framing up to 24" o.c. with wet texture and insulation loading.</p> <p>– Meets or exceeds ASTM C36; UL Classified as to shear resistance and surface burning. Class A material. Surface burning characteristics: flame spread 15, smoke developed 0.</p> <p>Size Available 1/2" thick; 4' wide; cut to specified lengths.</p> <p>Resources USG Literature Number MH1237</p>
	<p>SHEETROCK® MH Brand Gypsum Base Board</p> <p>Features</p> <ul style="list-style-type: none"> – Panels designed to accept laminated vinyl or paper film. – For creating prefinished interior partitions (laminated) and for lining furnace and water-heater rooms (unlaminated). – Square edges for tight-fitting panels—minimize batten width. <p>– Meets or exceeds the requirements of ASTM C36. UL Classified as to shear resistance and surface burning characteristics. Class A material. Surface burning characteristics: flame spread 15, smoke developed 0 (on plain gypsum base board).</p> <p>Size Available in 5/16", 3/8", and 1/2" thicknesses; 4' wide; cut to specified lengths.</p> <p>Resources USG Literature Number MH1174</p>
	<p>SHEETROCK® MH Brand Predecorated Ceiling Board—LUNAR™</p> <p>Features</p> <ul style="list-style-type: none"> – Decorative gypsum panels with factory-applied texture. – For application to ceilings in manufactured homes. – Square edges butt neatly to speed ceiling installation. <p>– Meet or exceed the requirements of ASTM C36. UL Classified as to shear resistance and surface burning characteristics. Class A material. Surface burning characteristics: flame spread 25, smoke developed 0.</p> <p>Size Available in 5/16" and 1/2" thicknesses; 4' wide; cut to specified lengths.</p> <p>Resources USG Literature Number MH1177</p>

Gypsum Board Products

	<p>SHEETROCK® Brand Regular Gypsum Panels</p> <p>Features</p> <ul style="list-style-type: none"> – Basic tapered-edge gypsum panels; non-shear-rated. – Easily cut and quickly applied. – Resist cracking and warping. <p>– Meet or exceed ASTM C36. Surface burning characteristics: flame spread 15, smoke developed 0.</p> <p>Size Available in 1/4", 3/8", and 1/2" thicknesses; 4' wide; 8', 9', 10', 12', and 14' lengths (except 1/4", available in 8' and 10' lengths only).</p> <p>Resources USG Literature Number WB1473</p>
	<p>SHEETROCK® Brand Gypsum Panels, FIRECODE® Core</p> <p>Features</p> <ul style="list-style-type: none"> – Basic gypsum panels with additional fire-resistance. – For use in fire-resistant rated assemblies. – Meet or exceed ASTM C36 for a Type X gypsum board, and meet the definition <p>of a Type X gypsum board for fire-rated assemblies in the Gypsum Association Fire Resistance Design Manual. Surface burning characteristics: flame spread 15, smoke developed 0.</p> <p>Size Available 5/8" thick; 4' wide; 8', 9', 10', 12', and 14' lengths.</p> <p>Resources USG Literature Number WB1473</p>
	<p>SHEETROCK® Brand Gypsum Panels, FIRECODE® C Core</p> <p>Features</p> <ul style="list-style-type: none"> – Gypsum panels with a specially formulated mineral core for fire-resistance superior to that offered by generic Type X panels. – Used in fire-rated systems to provide fire ratings of up to 4 hours in walls, 3 hours in ceilings, and 4 hours for column protection. <p>– Meet or exceed ASTM C36 for a Type X gypsum board, and meet the definition of a Type X gypsum board for fire-rated assemblies in the Gypsum Association Fire Resistance Design Manual. Surface burning characteristics: flame spread 15, smoke developed 0.</p> <p>Size Available in 1/2" and 5/8" thicknesses; 4' wide; 8', 9', 10', 12', and 14' lengths.</p> <p>Resources USG Literature Number WB1473</p>
	<p>SHEETROCK® Brand HUMITEK™ Gypsum Panels</p> <p>Features</p> <ul style="list-style-type: none"> – Gypsum panels with a non-combustible, moisture- and mold-resistant gypsum core that is encased in moisture resistant, 100 percent recycled blue face and brown back papers. <p>– Meet or exceed ASTM C36, C1396.</p> <p>– Per ASTM E84, surface burning characteristics: flame spread is 20; smoke developed is 0.</p> <p>Size Available in 1/2" and 5/8" thickness; 4' wide; 8'-12' lengths.</p> <p>Resources USG Literature Number WB2327</p>
	<p>SHEETROCK® Brand 54" Gypsum Panels</p> <p>Features</p> <ul style="list-style-type: none"> – Basic SHEETROCK® Brand Gypsum Panels, manufactured 54" wide. – For use in homes with 9' ceilings, or anywhere use of a wider board will result in fewer joints. <p>– Reduce taping labor and materials expense.</p> <p>– Meet or exceed ASTM C36. Surface burning characteristics: flame spread 15, smoke developed 0.</p> <p>Size Available 1/2" thick; 54" wide; 8', 9', 10', 12', and 14' lengths.</p> <p>Resources USG Literature Number WB1473</p>
	<p>SHEETROCK® Brand 1/4" Flexible Gypsum Panels</p> <p>Features</p> <ul style="list-style-type: none"> – Gypsum panels formulated to be more flexible than standard 1/4" drywall. – For creating curved walls, archways, and staircases. <p>– Meet or exceed ASTM C36. Surface burning characteristics: flame spread 15, smoke developed 0.</p> <p>Size Available in 8' and 10' lengths.</p> <p>Resources USG Literature Number WB2128</p>
	<p>SHEETROCK® Brand Gypsum Panels, Water-Resistant</p> <p>Features</p> <ul style="list-style-type: none"> – Panels manufactured with water-resistant face paper, core, and back paper. – For use in kitchens, bathrooms, and utility rooms. <p>– Combine added moisture resistance with the easy handling and installation offered by regular gypsum panels.</p> <p>– Meet or exceed ASTM C630. Surface burning characteristics: flame spread 20, smoke developed 0. The 5/8" version has a Type X core.</p> <p>Size Available in 1/2" and 5/8" thicknesses; 4' wide; 8', 10', and 12' lengths. Also available with FIRECODE and FIRECODE C Cores.</p> <p>Resources USG Literature Number WB634</p>
	<p>SHEETROCK® Brand Gypsum Sheathing</p> <p>Features</p> <ul style="list-style-type: none"> – A fire-resistant exterior gypsum sheathing consisting of a water-resistant core with black water repellent paper on both sides and long edges. <p>– Meets or exceeds ASTM C79. Surface burning characteristics: flame spread 20, smoke developed 0.</p> <p>Size Sizes and edge configurations available vary by region. Consult your USG representative for further information.</p> <p>Resources USG Literature Number SA927</p>

Joint Compounds

USG offers both setting-type and drying-type joint compounds in various formulations for different uses.

Setting-Type Joint Compounds

Setting-type joint compounds harden chemically before drying. This makes them particularly useful for industrialized construction, because speed is of the essence on the assembly line, and because units must often be moved before joints are completely dry. Setting-type compounds can be used with both fiberglass and paper joint tapes. Generally, stronger compounds tend to be harder working and very difficult to sand, while lighter-weight, more easily sanded compounds tend to develop less strength.

SHEETROCK® MH Brand Setting-Type Joint Compound—TUF-SET™ High Early Strength (HES)



Features

- A chemically hardening (setting-type) compound for treating wallboard joints in the manufactured housing industry. Has the lowest water demand among USG compounds for the highest joint strength.
- For use on wall and ceiling joints whenever rapid development of high strength is a manufacturing necessity.
- Sets quickly for fast joint finishing, allowing rapid movement along the assembly line.
- Reduced water demand means quicker drying time.
- Meets or exceeds ASTM C475.

Size

Available in 15, 20, 30, 45, 60 and 90 minute set times; 25 lb. bag.

Resources

USG Literature Number MH1225

SHEETROCK® MH Brand Lightweight Setting-Type Joint Compound—TUF-SET™ Lite



Features

- A sandable, chemically hardening (setting-type) compound designed for use in the Manufactured Housing industry.
- For use on wall and ceiling joints in manufactured homes, whenever sanding is required. Ideal for second and third coats.
- Sets quickly and sands easily for rapid joint finishing and decorating.
- Offers check-crack resistance in heavy fills.
- Mixes very easily to a lump-free consistency.
- Meets or exceeds ASTM C475.

Size

Available in 15, 20, 30, 45, 60, 90, and 210 minute set times; 18 lb. bag.

Resources

USG Literature Number MH1180

SHEETROCK® MH Brand Setting-Type Joint Compound—TUF-SET™



Features

- A high strength, chemically hardening (setting-type) compound designed specifically for the Manufactured Housing Industry.
- For use on wall and ceiling joints of manufactured homes; particularly good for embedding tape and for first coats.
- Sets quickly for rapid joint finishing and decorating.
- Meets or exceeds ASTM C475.

Size

Available in 15, 20, 30, 45, 60, 90, and 210 minute set times; 25 lb. bag.

Resources

USG Literature Number MH1179

SHEETROCK® Brand Lightweight Setting-Type Joint Compound (EASY SAND™)



Features

- A lightweight, chemically hardening (setting-type), easy-to-sand joint compound.
- For use on wall and ceiling joints, whenever sanding is required. Ideal for second and third coats.
- Weighs 25% less than conventional setting-type compounds.
- Offers unique humidity resistance, exceptional bond, and low shrinkage.
- Provides check-crack resistance in heavy fills.
- Meets or exceeds ASTM C475.

Size

Available in 20, 45, 90, 210, and 300 minute set times; 18 lb. bag. EASY SAND 90 also available in 4 lb. box.

Resources

USG Literature Number J621

Joint Compounds

SHEETROCK® Setting-Type Joint Compound—DURABOND®



Features

- A general-purpose chemically hardening (setting-type) compound that permits quick finishing and decoration.
- For finishing wall and ceiling joints; ideal for heavy fills and for patching. An easy-working compound recommended for use where the strength of TUF-SET Compounds is not required.
- Meets or exceeds ASTM C475.

Size

Available in 20, 45, 90, 210, and 300 minute set times; 25 lb. bag.

Resources

USG Literature Number J17A

Drying-Type Joint Compounds

Drying-type joint compounds, which contain water, must be allowed to dry completely to ensure creation of a strong joint. They can only be used with paper joint tapes.

SHEETROCK® Brand All Purpose Joint Compound



Features

- A versatile, ready-mixed, drying-type joint compound.
- Used for taping, topping, and texturing.
- Ready-mixed formulation ensures product uniformity.
- Easy to apply; offers good slip and excellent bond.
- Meets or exceeds ASTM C475.

Size

– Available in 1 qt. plastic container; 12 lb., 42 lb., and 61.7 lb. plastic pails; and 61.7 lb., and 50 lb. cartons.

Resources

USG Literature Number J60A

SHEETROCK® Brand Topping Joint Compound



Features

- A low-shrinkage, easily applied, sandable, ready-mixed drying-type joint compound.
- For topping and texturing.
- Smooth, creamy consistency; excellent slip; easy workability.
- Factory mixed for product uniformity.
- Low shrinkage for a finer finish.
- Meets or exceeds ASTM C475.

Size

Available in 1 qt. plastic container; 12 lb., 42 lb., and 61.7 lb. plastic pails; and 61.7 lb., and 50 lb. cartons.

Resources

USG Literature Number J60A

SHEETROCK® Brand Lightweight All Purpose Joint Compound—PLUS 3™



Features

- A lightweight, easy-to sand, ready-mixed drying-type joint compound.
- For taping, topping, and texturing.
- Weighs up to 35% less than conventional compounds.
- Requires only two coats over metal beads and trims, saving time and labor.
- Meets or exceeds ASTM C475.

Size

Available in 1 gal. and 4.5 gal. pails; 4.5 gal., and 3.5 gal. cartons.



Resources

USG Literature Number J498A

Texture Selector

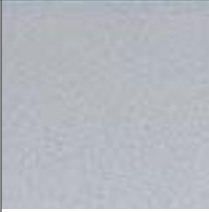

The table below details SHEETROCK Brand Texture product information for interior walls and ceilings. For additional information on SHEETROCK Brand Interior Finishing Systems, please see USG Literature Number J1424.

Walls and Ceilings



Finish/Pattern		SHEETROCK Brand Texture Products	Application Method	Coverage	Finish Coat of Paint	Level*
Fine Sand		SHEETROCK Wall & Ceiling Spray Texture (Sand Finish TEXTURE 12)	Spray	to 35 sq. ft./lb.	Topcoat Required	4
		SHEETROCK Wall & Ceiling Texture Paint (TEXOLITE Sanded Paste Stipple)	Roller or Brush or Spray	to 200 sq. ft./gal.	Not Required	4
		SHEETROCK Wall & Ceiling Texture Paint (Sand Finish TEXTURE 1)	Roller or Brush or Spray	to 200 sq. ft./gal.	Not Required	4
Stomp or Crowsfoot		SHEETROCK Wall & Ceiling Spray Texture (Multipurpose)	Roller or Spray, then Brush	10-20 sq. ft./lb.	Topcoat Required	4
		SHEETROCK Wall & Ceiling Texture, Ready to Use	Roller then Brush	to 70 sq. ft./gal.	Topcoat Required	4
		SHEETROCK Wall & Ceiling Texture (TUF-TEX)	Roller or Spray, then Brush	10-20 sq. ft./lb.	Topcoat Required	4
		SHEETROCK Brand Topping Joint Compound Ready-Mixed	Roller or Spray	to 70 sq. ft./gal.	Topcoat Required	4
		SHEETROCK Brand All Purpose Joint Compound, Ready-Mixed	Roller or Spray	to 70 sq. ft./gal.	Topcoat Required	4
Swirl		SHEETROCK Wall & Ceiling Texture (Multipurpose)	Roller or Spray, then Brush	10-20 sq. ft./lb.	Topcoat Required	4
		SHEETROCK Wall & Ceiling Texture, Ready to Use	Roller then Brush	to 70 sq. ft./gal.	Topcoat Required	4
		SHEETROCK Wall & Ceiling Texture (TUF-TEX)	Roller or Spray, then Brush	10-20 sq. ft./lb.	Topcoat Required	4
		SHEETROCK Brand Topping Joint Compound Ready-Mixed	Roller or Spray, then Brush	to 70 sq. ft./gal.	Topcoat Required	4
		SHEETROCK Brand All Purpose Joint Compound, Ready-Mixed	Roller or Spray, then Brush	to 70 sq. ft./gal.	Topcoat Required	4
Stipple		SHEETROCK MH Unaggregated Spray Texture – TUF-TEX	Spray	10-20 sq. ft./lb. (heavier texture) 20-40-sq.ft./lb (lighter texture)	Topcoat Required	4
		SHEETROCK Wall & Ceiling Texture (Multipurpose)	Roller, or Spray then Roller	10-20 sq. ft./lb.	Topcoat Required	4
		SHEETROCK Wall & Ceiling Texture, Ready to Use	Roller	to 70 sq. ft./gal.	Topcoat Required	4
		SHEETROCK Wall & Ceiling Texture (TUF-TEX)	Roller, or Spray then Roller	10-20 sq. ft./lb.	Topcoat Required	4
Fine Orange Peel		SHEETROCK MH Unaggregated Spray Texture – TUF-TEX	Spray	10-20 sq. ft./lb. (heavier texture) 20-40-sq.ft./lb (lighter texture)	Topcoat Required	4
		SHEETROCK Wall & Ceiling Texture (Multipurpose)	Spray	10-40 sq. ft./lb.	Topcoat Required	4
		SHEETROCK Wall & Ceiling Spray Texture	Spray	20-40 sq. ft./lb.	Topcoat Required	4
		SHEETROCK Wall & Ceiling Texture (TUF-TEX)	Spray	20-40 sq. ft./lb.	Topcoat Required	4

Texture Selector

Walls and Ceilings

Finish/Pattern		SHEETROCK Brand Texture Products	Application Method	Coverage	Finish Coat of Paint	Level*
Orange Peel		SHEETROCK MH Unaggregated Spray Texture – TUF-TEX	Spray	10-20 sq. ft./lb. (heavier texture) 20-40-sq.ft./lb (lighter texture)	Topcoat Required	4
		SHEETROCK Wall & Ceiling Spray Texture	Spray	20-40 sq. ft./lb.	Topcoat Required	4
		SHEETROCK Wall & Ceiling Texture (TUF-TEX)	Spray	20-40 sq. ft./lb.	Topcoat Required	4
		SHEETROCK Wall & Ceiling Spray Texture, Ready Mixed	Spray	to 200 sq. ft./gal.	Topcoat Required	4
Spatter		SHEETROCK MH Unaggregated Spray Texture – TUF-TEX	Spray	10-20 sq. ft./lb. (heavier texture) 20-40-sq.ft./lb (lighter texture)	Topcoat Required	3
		SHEETROCK Wall & Ceiling Spray Texture	Spray	20-40 sq. ft./lb.	Topcoat Required	3
		SHEETROCK Wall & Ceiling Texture (TUF-TEX)	Spray	20-40 sq. ft./lb.	Topcoat Required	3
		SHEETROCK Wall & Ceiling Spray Texture, Ready Mixed	Spray	to 200 sq. ft./gal.	Topcoat Required	4
Knockdown		SHEETROCK MH Unaggregated Spray Texture – TUF-TEX	Spray	10-20 sq. ft./lb. (heavier texture) 20-40-sq.ft./lb (lighter texture)	Topcoat Required	3
		SHEETROCK Wall & Ceiling Spray Texture	Spray then Trowel	10-25 sq. ft./lb.	Topcoat Required	3
		SHEETROCK Wall & Ceiling Texture (TUF-TEX)	Spray then Trowel	10-25 sq. ft./lb.	Topcoat Required	3
		SHEETROCK Wall & Ceiling Spray Texture, Ready Mixed	Spray then Trowel	to 100 sq. ft./gal.	Topcoat Required	3

Ceilings





Finish/Pattern		SHEETROCK Brand Texture Products	Application Method	Coverage	Finish Coat of Paint	Level*
Coarse		SHEETROCK MH Aggregated Ceiling Spray Texture – TUF-SPRAY	Spray	10-14 sq. ft./lb.	Topcoat Required	3
		SHEETROCK Ceiling Spray Texture (QT Polystyrene Coarse)	Spray	8-10 sq. ft./lb.	Not Required	3
Medium Aggregated		SHEETROCK MH Aggregated Ceiling Spray Texture – TUF-SPRAY	Spray	10-14 sq. ft./lb.	Topcoat Required	3
		SHEETROCK Ceiling Spray Texture (QT Polystyrene Medium)	Spray	8-10 sq. ft./lb.	Not Required	3
Fine Aggregated		SHEETROCK Ceiling Spray Texture (QT Polystyrene Fine)	Spray	8-10 sq. ft./lb.	Not Required	4

*Recommended minimum level of gypsum board finish.



Notes: Apply all texture products over a surface prepared to the level of finish specified in GA-214 *Levels of Gypsum Board Finish*. Prime substrate with SHEETROCK Brand First Coat flat latex wall paint. "Coverage" provides a relative comparison between products applied according to directions; not recommended for job estimating. Coverage can vary widely depending on substrate conditions, mixing proportions, application procedures, and texture appearance desired.

Textures and Texture Paints

USG offers a wide variety of products for both spray texturing and hand-tooling. A selection of the most popular texture products is shown below. For additional information on texturing procedures and product availability, please see USG Literature Number SA933.

SHEETROCK® MH Brand Unaggregated Spray Texture—TUF-TEX™		SHEETROCK® Brand Wall and Ceiling Texture—TUF-TEX™	
	<p>Features</p> <ul style="list-style-type: none"> – An unaggregated texture coating formulated to create patterns such as spatter, spatter/knockdown, and orange peel on the assembly line. – For texturing interior wall and ceiling surfaces in manufactured homes. – Easy to mix and use; conceals minor imperfections. <p>Size Available in 40 lb. bag.</p> <p>Resources USG Literature Number MH1182</p>		<p>Features</p> <ul style="list-style-type: none"> – An unaggregated texture coating designed to produce a variety of patterns from bold spatter/knockdown to light orange peel. – For texturing interior wall and ceiling surfaces. – Creates attractive texture finishes that conceal minor defects economically. – Easy to mix and use. <p>Size Available in 40 lb. bag.</p> <p>Resources USG Literature Number J751</p>
SHEETROCK® MH Brand Aggregated Ceiling Spray Texture—TUF-SPRAY™		SHEETROCK® Brand Wall and Ceiling Spray Texture—Sand Finish Texture 12	
	<p>Features</p> <ul style="list-style-type: none"> – An aggregated product formulated to create striking textures in an assembly-line environment. – For texturing ceilings in manufactured homes. – Produces a visually interesting texture with excellent aggregate stand-out when dry. – Excellent coverage with low aggregate bounce-back. – Covers minor surface cracks and blemishes. – Dries quickly to speed finishing and reduce overall costs. <p>Size Available in Medium and Coarse aggregate; 35 lb. bag.</p> <p>Resources USG Literature Number MH1181</p>		<p>Features</p> <ul style="list-style-type: none"> – An aggregated white coating for spray application to produce a sand-finish effect. – For texturing interior gypsum walls and ceilings. – Conceals minor surface defects economically. – Designed for fast, low-cost spray application. – Dries quickly; provides excellent hide. – Can be left unpainted on ceilings. <p>Size Available in 25 lb. bags.</p> <p>Resources USG Literature Number J382</p>

Textures and Texture Paints

<p>SHEETROCK® Brand Ceiling Spray Texture—QT Poly</p> 	<p>Features</p> <ul style="list-style-type: none"> – A spray texture containing polystyrene aggregate for producing a handsome acoustical ceiling finish with no acoustical correction. – For texturing non-contact gypsum ceiling surfaces. – Easy to mix and spray; conceals minor defects. – Dries to a white finish that typically can be left unpainted. <p>Size Available in Fine, Medium, and Coarse aggregate; 32 lb. and 40 lb. bags.</p> <p>Resources USG Literature Number J378</p>	<p>SHEETROCK® Brand Wall and Ceiling Spray Texture</p> 	<p>Features</p> <ul style="list-style-type: none"> – A texture finish for creating moderate to bold patterns. – For texturing interior walls and ceilings. – Superior open time for hand-tooled knockdown finishes. – Excellent stand-out helps conceal minor surface imperfections. – Dries to a firm, soft-tone white surface (should be overpainted when dry). <p>Size Available in Unaggregated and Aggregated; 40 lb. and 50 lb. bags.</p> <p>Resources USG Literature Number J377</p>
<p>SHEETROCK® Brand Wall and Ceiling Texture—Multi-Purpose</p> 	<p>Features</p> <ul style="list-style-type: none"> – An economical, unaggregated powder product that produces patterns such as crowsfoot, swirl, stipple, and fine orange peel. – For texturing interior walls and ceilings. – Excellent coverage; conceals minor surface defects. – Dries fast to a hard white finish that may be left unpainted on ceilings. <p>Size Available in 25 lb. and 40 lb. bags.</p> <p>Resources USG Literature Number J383</p>	<p>SHEETROCK® Brand Wall and Ceiling Texture Paint—Sand Finish Texture 1</p> 	<p>Features</p> <ul style="list-style-type: none"> – An aggregated white latex texture paint that produces a light sand finish with a light-bodied under-texture. – For creating a dramatic texturing effect over interior wall and ceiling surfaces. <p>Size Available in 1 gal. and 5 gal. pails.</p> <p>Resources USG Literature Number J917</p>

SHEETROCK® Wall and Ceiling Spray Texture



- Features**
- A ready-mixed vinyl formulation that produces a variety of light, appealing textures, including spatter, spatter/knockdown, and orange peel.
 - For texturing interior wall and ceiling surfaces.
 - Hides minor surface imperfections.

Size
Available in 3.5 gal. carton.

Resources
USG Literature Number J1130

**SHEETROCK® Brand Wall and Ceiling Texture Paint—
TEXOLITE™ Sanded Paste Stipple**



- Features**
- A white latex texture paint that produces a classic light sand finish.
 - For interior walls and ceilings.
 - Economical to use—covers up to 200 sq. ft. per gallon.
 - Dries to a hard, durable, natural white finish.

Size
Available in 1 gal. and 5 gal. pails.

Resources
USG Literature Number J692

SHEETROCK® Brand Latex Additive for Textures



- Features**
- A latex emulsion additive that improves the overall performance of SHEETROCK Brand spray textures.
 - For addition to SHEETROCK Brand spray textures whenever additional adhesion of texture to substrate is desired.
 - Improves durability and surface hardness of texture finishes.
 - Strengthens bond of the aggregate.

Size
Available in 5 gal. pail.

Resources
USG Literature Number J546

Paper Faced Metal Bead and Trim

USG offers many bead and trim products that can be used to create strong, attractive joints for both outside and inside angles.

SHEETROCK™ Brand Paper Faced Metal Drywall Bead and Trim—Tape-On Version:

- A metal bead and trim product with a paper-tape covering that facilitates finishing.
- For inside and outside corners, as well as for coves, vaulted ceilings, and other specialized applications.
- Tape-on version “floats” with the gypsum wall surface when a manufactured home is moved, eliminating edge cracking when a unit is in transit.
- Fast, easy installation reduces labor costs; performance reduces repair costs.
- Excellent for use with setting-type compounds for quicker finishing and decoration.
- Paper-tape covering resists scuffing and fuzzing.
- Meets or exceeds ASTM C1047.
- Available in a wide variety of sizes and profiles, as well as in nail-on versions. Some of the most popular tape-on styles are shown below.
- See USG Literature Number J1424 for a complete listing of the sizes and styles available.

SHEETROCK Brand Paper Faced Metal Outside Corner, Tape-On Bead
(B1W, B1WX, B1 Super Wide)

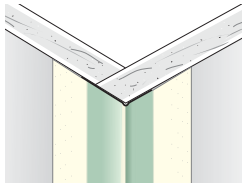

Style	Dimensions			
	A	B	C	D
B1W	3/4"	13/16"	9/16"	3/4"
B1W NB	3/4"	13/16"	9/16"	3/4"
B1XW	5/8"	15/16"	11/16"	5/8"
B1XW EL	5/8"	13/16"	13/16"	5/8"
B1XW NB	5/8"	15/16"	11/16"	5/8"
B1XW ELNB	5/8"	13/16"	13/16"	5/8"
B1 Super Wide	11/16"	1-1/16"	1-1/16"	11/16"

Note: XW = Extra Wide; EL = Even Leg; NB = No Bead.

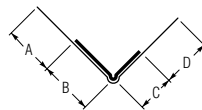

SHEETROCK Brand Paper Faced Metal Inside Corner, Tape-On Trim
(B2)

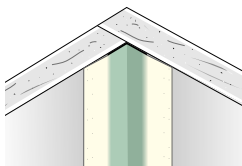

Style	Dimensions			
	A	B	C	D
B2	5/8"	3/8"	3/8"	5/8"

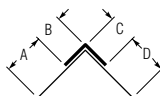

SHEETROCK Brand Paper Faced Metal Offset Outside Corner, Tape-On Bead
(B1 OS)

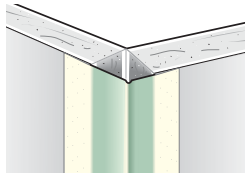

Style	Dimensions			
	A	B	C	D
B1 OS	5/8"	3/4"	1/2"	5/8"

Note: OS = Offset

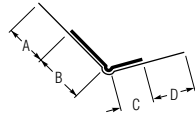

SHEETROCK Brand Paper Faced Metal Offset Inside Corner, Tape-On
(B2 OS)

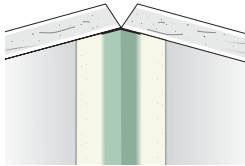

Style	Dimensions			
	A	B	C	D
B2 OS	5/8"	5/8"	5/8"	5/8"

Note: OS = Offset

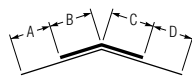

SHEETROCK Brand Paper Faced Metal 1-1/2" Bullnose Outside Corner, Tape-On Bead (Danish)

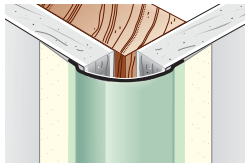

Style	Dimensions		
	A	Radius	B
DANISH	3/4"	1-1/2"	3/4"

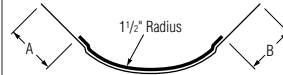

SHEETROCK Brand Paper Faced Metal 3/4" Bullnose Inside Corner, Tape-On (SLIC)

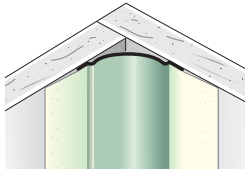

Style	Dimensions		
	A	Radius	B
SLIC	3/4"	3/4"	3/4"



SHEETROCK Brand paper Faced Metal 3/4" Bullnose Offset Inside Corner, Tape-On (SLIC OS)

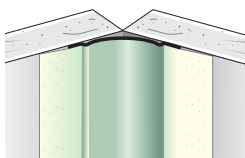

Style	Dimensions		
	A	Radius	B
SLIC OS	5/8"	3/4"	5/8"

Note: OS = Offset

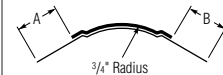

SHEETROCK Brand Flex Metal Tape, Tape-On Flexible Corner
(Flex Tape)

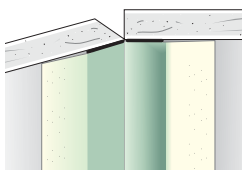

Style	Dimensions			
	A	B	C	D
Flex Tape (2-1/16")	9/16"	7/16"	7/16"	9/16"
Flex Tape (4")	1-1/8"	7/8"	7/8"	1-1/8"

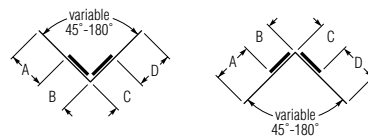



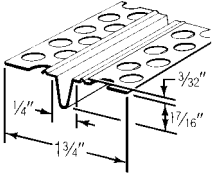
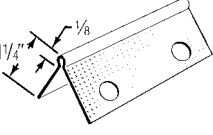

Metal Bead and Trim

Provides protection and neat finished edges for corners, gypsum panels at window and door jambs, ceilings and intersections where panels abut other materials.

Zinc Control Joint No. 093	DURABEAD® Corner Bead
 <p>Features</p> <ul style="list-style-type: none"> - A roll-formed zinc joint with a tape-protected opening. - Used to relieve stresses of expansion and contraction across the joint in large expanses of wall or ceiling. <p>Size</p> <p>Available in 10' length; tape-protected opening is 1/4" wide and 7/16" deep.</p> <p>Resources</p> <p>USG Literature Number SA927</p>	 <p>Features</p> <ul style="list-style-type: none"> - An all-metal galvanized steel corner reinforcement. - Provides superior joint compound adhesion. <p>Size</p> <p>Available in 1-1/4" x 1-1/4" flange width (no. 103).</p> <p>Resources</p> <p>USG Literature Number SA927</p>



Joint Tapes

USG manufactures a number of joint tapes to suit a range of applications. Fiberglass-type joint tapes must be used with setting-type joint compounds; paper tapes can be used with both setting-type and drying-type joint compounds.

<p>SHEETROCK® MH Brand Joint Tape—TUF-TAPE™</p>  <p>Features</p> <ul style="list-style-type: none"> – A self-adhesive fiberglass joint tape. – Recommended for finishing flat joints in manufactured homes. – Cross-fiber construction for greater joint strength and crack resistance. – Provides smooth finished joints in one or two coats when used with SHEETROCK MH Brand Setting-Type Joint Compounds. <p>Size</p> <p>Available in 1-7/8" and 2-1/2" widths; 250' rolls.</p> <p>Resources</p> <p>USG Literature Number MH1178</p>	<p>SHEETROCK® Brand Joint Tape</p>  <p>Features</p> <ul style="list-style-type: none"> – Versatile paper tape for use with setting- or drying-type compound. – Recommended for finishing interior angles. – Precreased for easier corner application. – Thin, strong paper permits easier joint treatment. – Roughened surface provides superior bond. – Cross-fibered paper provides high tensile strength; resists tearing, stretching, and distortion. <p>Size</p> <p>Available 1-31/32" wide; 75', 250', and 500' rolls.</p> <p>Resources</p> <p>USG Literature Number MH1178</p>
<p>IMPERIAL® Brand Tape, Type P</p>  <p>Features</p> <ul style="list-style-type: none"> – A glass-fiber tape for use with high-strength setting-type joint compounds. – Recommended for finishing flat joints in manufactured homes. – Pressure-sensitive backing permits quick, self-stick hand application. – Thin tape allows easy coverage. – Resists cracking; special weave reduces raveling. <p>Size</p> <p>Available in 2" and 2-1/2" widths; 300 ft. rolls.</p> <p>Resources</p> <p>USG Literature Number MH1178</p>	<p>SHEETROCK® Brand Flexible Metal Corner Tape</p>  <p>Features</p> <ul style="list-style-type: none"> – Rust-resistant steel strips bonded to paper tape to form a uniquely flexible corner bead. – Used to ensure sharp, straight corners. Particularly useful for cathedral ceilings and arches. – Easy to apply—fold down center margin and press into joint compound. – Coated paper tape resists scuffing and fuzzing from knives and sanding. <p>Size</p> <p>Available 2-1/16" wide; 100' roll in dispenser box.</p> <p>Resources</p> <p>USG Literature Number J549</p>
<p>VALUEMESH™ MH Joint Tape</p>  <p>Features</p> <ul style="list-style-type: none"> – Glass fiber mesh tape for reinforcing drywall joints in Industrialized Construction. – Speeds finish operations in the plants. – Rolls are marked with starter strip for ease of use. – Easy to cut at end of joint. – Self adhesive for ease of application. – Designed for use with setting type joint compounds. <p>Size</p> <ul style="list-style-type: none"> – Available in 2-3/8" and 1-7/8" wide rolls. – Convenient bulk pack for reduced packaging waste. <p>Resources</p> <p>USG Literature Number MH1283</p>	



Gypsum Fiber Panels

USG's FIBEROCK® Brand Panels combine gypsum and cellulose fibers in a patented formulation to provide unique benefits in the areas of abuse resistance, stability, water resistance and environmental responsibility.

<p>FIBEROCK® Brand Underlayment—AQUA-TOUGH™</p> 	<p>Features</p> <ul style="list-style-type: none"> – Gypsum-fiber panel for floor underlayment in residential construction. – For use under vinyl, wood, carpeting, and ceramic tile, in both wet and dry areas. – Offers a smooth, uniform surface to reduce ridging. – Provides greater dimensional stability than wood-based products. – Uniform thickness reduces lipping. – Contains no resins or adhesives that can stain vinyl flooring. <p>Size Available 1/4" thick, 4' wide and 4' long; or 3/8" thick, 4' wide, 4' and 8' long.</p> <p>Resources USG Literature Number F103</p>	<p>FIBEROCK® Brand Sheathing—AQUA-TOUGH™</p> 	<p>Features</p> <ul style="list-style-type: none"> – Water-resistant exterior sheathing. – For use in water-managed exterior insulation and finish systems, and for other exterior applications. – Uniform composition provides strength and water resistance with no facing layer to delaminate. – Embossed drainage pattern on back of panel helps remove intruding water. – Provides superior fastener-holding strength. – 5/8" panels are classified Type X for fire-resistive assemblies. <p>Size Available 1/2" and 5/8" thick, 48" wide, 8'-12' long.</p> <p>Resources USG Literature Number F135</p>
<p>FIBEROCK® Brand Panels—Abuse Resistant and VHI Abuse Resistant</p> 	<p>Features</p> <ul style="list-style-type: none"> – Gypsum-fiber panels designed for superior abuse resistance. – For areas subject to abuse or heavy traffic, such as corridors, classrooms, and clinics. – Resist denting, breaking, and puncturing. – Provide excellent fire resistance. – Reduce life-cycle costs. <p>Size Available 1/2" and 5/8" thick, and in 5/8" VHI version with embedded fiber-glass mesh; 4' wide; 8', 9', 10' and 12' long.</p> <p>Resources USG Literature Numbers F102 and F218</p>		

Cement Board

In addition to its line of SHEETROCK Brand Gypsum Panels and accessories, USG markets a number of different cement board and accessory products under the DUROCK Brand name. DUROCK Brand provides “Strength Beneath the Surface” for superior performance under ceramic tile and areas prone to heat and moisture.

Durock® Brand Cement Board	Durock® Brand Underlayment
 <p>Features</p> <ul style="list-style-type: none"> – An aggregated portland cement board with a coated glass-mesh reinforcement scrim. – Used as a water-durable backer for ceramic and other tiles in high-moisture areas. Also used as a wall shield/floor protector for UL-listed solid-fuel room heaters and stoves. – Noncombustible panel contains no asbestos, but is highly fire-resistant. – Exceeds the ANSI Standards for cementitious backer units (CBU). Meets ASTM Standard E136 for noncombustibility. <p>Size Available 1/2" thick; 32" wide and 5' long; 36" wide in 4', 5', 6', and 8' lengths; 48" wide and 8' long.</p> <p>Resources USG Literature Number SA932</p>	 <p>Features</p> <ul style="list-style-type: none"> – A 5/16" Durock Brand Cement Board designed specifically for use as an underlayment. – For use under floors and countertops. – Provides extra water durability and strength for entryways and other areas subject to heavy usage and moisture exposure. – Nominal 5/16" thickness helps eliminate transition trim when abutting carpet or wood flooring; helps minimize level variations with other finish materials. – Exceeds the ANSI Standards for cementitious backer units (CBU). Meets ASTM Standard E136 for noncombustibility. <p>Size Available 5/16" thick; 48" wide and 4' long; 36" wide and 5' long.</p> <p>Resources USG Literature Number SA932</p>

Primers

A good prime coat is vital to ensure problem-free decorating and a beautiful finished look.

SHEETROCK® Brand First Coat	SHEETROCK® Brand Wallcovering Primer
 <p>Features</p> <ul style="list-style-type: none"> – A flat latex primer that minimizes both texture and porosity differences to prevent joint banding. – For use as a first coat over all gypsum panels, especially in critical lighting situations. Can also be intermixed with wall and ceiling spray textures to enhance hardness, bond, and whiteness. – Dries to a white finish in under 30 minutes. – Designed for fast, economical application with spray equipment. <p>Size Available in 1 gal. and 5 gal. pails. Disposable bulk totes are available from Gypsum, Ohio.</p> <p>Resources USG Literature Number J1095</p>	 <p>Features</p> <ul style="list-style-type: none"> – A ready-mixed primer formulated to prevent wallcovering adhesive from soaking into porous wall surfaces. – For use as a basecoat whenever a wallcovering is to be applied to gypsum panels (can also be used over plaster, stripped wallpaper, and masonry). – Prepares and seals wall surface for decoration. – Permits later removal of wallpaper. – Dries quickly to a smooth working surface. <p>Size Available in 1 gal. and 5 gal. pails.</p> <p>Resources USG Literature Number J945</p>

Primer Surfacer

SHEETROCK® Brand Primer-Surfacer, TUFF-HIDE™ is a dual-purpose vinyl, acrylic latex-based coating designed especially for interior application over new drywall. In a single spray application it provides the same results achieved using a typical two-step process of skim coating surfaces with joint compound followed by a coat of primer.

SHEETROCK® Brand Primer-Surfacer (TUFF-HIDE™) (5 gal. pail)	
 <p>Features</p> <ul style="list-style-type: none"> – Use in lieu of skim coat and primer coat in a Level 5 gypsum board finish. – Minimizes callbacks caused by joint banding and photographing. – Installed cost savings versus traditional separate applications of skim coat and a prime coat. – Durable coating hides minor surface defects. <p>Size 5 gallon pail; 50 gallon drum</p> <p>Resources USG Literature Number J1613</p>	

Special Sealants

USG offers specially formulated compounds that can add fire resistance and acoustical privacy to any structure.

SHEETROCK® Brand Acoustical Sealant	FIRECODE® Compound
 <p>Features</p> <ul style="list-style-type: none"> – A highly elastic water-based sealant. – For reducing sound transmission at the perimeters of partitions and around cutouts. – Easy to apply; bonds to both porous and nonporous materials, remaining flexible. – Paintable and nonstaining; cleans up with soap and water. – Surface burning characteristics: flame spread 0, smoke developed 0 when tested in accordance with ASTM E84. <p>Size Available in 29 oz. cartridge and 5 gal. pail.</p> <p>Resources USG Literature Number J678</p>	 <p>Features</p> <ul style="list-style-type: none"> – A mortar-type firestopping compound. – For use at floor and wall penetrations. – Seals out fire, smoke, and toxic gas. – Fresh compound bonds to cured compound for simple repairs. – Can be sanded smooth and painted. – Surface burning characteristics: flame spread 0, smoke developed 0 when tested in accordance with ASTM E84. <p>Size Powder form available in 15 lb. bag; ready-mixed form (with activator) available in 3 qt. and 4.5 gal. pails.</p> <p>Resources USG Literature Number SA727</p>



Technical Service

800.USG.4YOU

Web Site

www.usg.com

Samples/Literature

888.874.2450

Samples/Literature E-mail

samplit@usg.com

Samples/Literature/Fax

888.874.2348

Customer Service

800.950.3839

Trademarks

The following trademarks used herein are owned by United States Gypsum or a related company: AQUA-TOUGH, DURABEAD, DURABOND, DUROCK, EASY SAND, FIBEROCK, FIRECODE, HUMITEK, IMPERIAL, INSULSCREEN, LUNAR, PLUS 3, SHEETROCK, SPEED BEAD, TEXOLITE, TUFF-HIDE, TUF-BASE, TUF-SET, TUF-SPRAY, TUF-TAPE, TUF-TEX, ULTRA-BASE, USG.

Note

Products described here may not be available in all geographic markets. Consult your USG sales office or representative for information.

Notice

We shall not be liable for incidental and consequential damages, directly or indirectly sustained, nor for any loss caused by application of these goods not in accordance with current printed instructions or for other than the intended use. Our liability is expressly limited to replacement of defective goods. Any claim shall be deemed waived unless made in writing to us within thirty (30) days from date it was or reasonably should have been discovered.

Safety First!

Follow good safety and industrial hygiene practices during handling and installing of all products and systems. Take necessary precautions and wear the appropriate personal protective equipment as needed. Read material safety data sheets and related literature on products before specification and/or installation.



Manufactured by
United States Gypsum Company
125 South Franklin Street
Chicago, IL 60606

MH1202/rev. 10-03
© 2003, United States Gypsum Company
Printed in U.S.A.