



ARCHITECTURAL PRECAST TERRAZZO
by **WAUSAU TILE**

MADE IN
WAUSAU[®]



CUSTOM STAIRCASES



NEW!
EcoPremier™

Recycled porcelain 100% aggregate replacement
Shown at surface or contained within finished product



Tread and Riser

Samples and drawings included.
Engineering consulting available to architects.

PRECAST INTERIOR ACCESSORIES



Base Trim



Base Trim



Base Trim & Column Covers



Column Cover



Window Sills

CEMENT TERRAZZO DETAILS

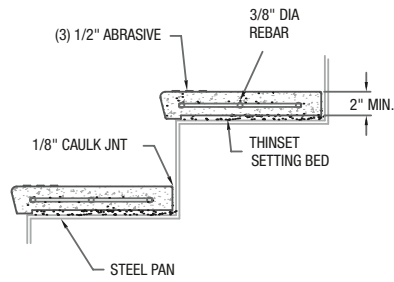

S-30 CEMENT TERRAZZO TREAD

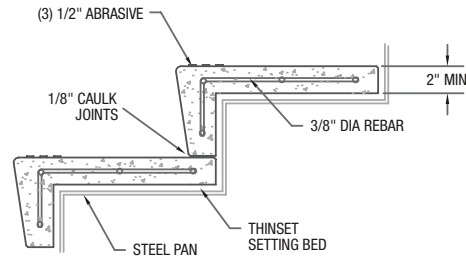

S-31 CEMENT TERRAZZO TREAD AND RISER

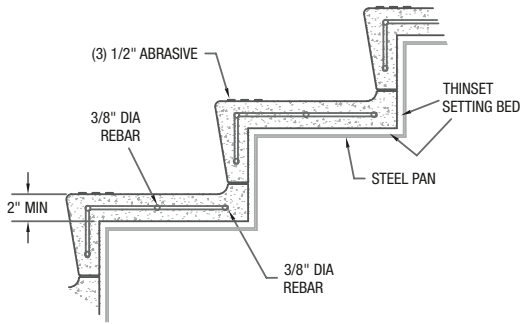

S-41 CEMENT TERRAZZO TREAD AND RISER

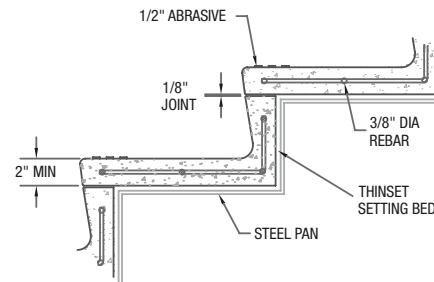

S-36 CEMENT TERRAZZO TREAD AND RISER

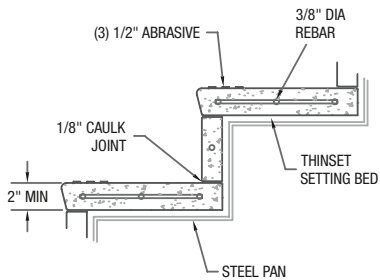

S-40 CEMENT TERRAZZO SEPARATE TREAD AND RISER

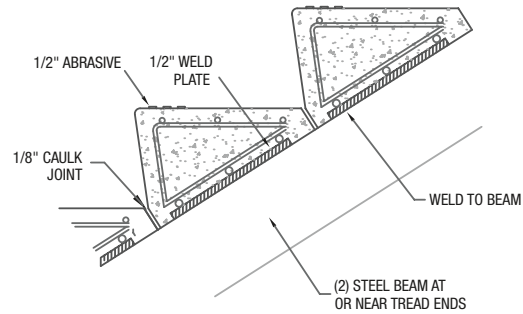

CUSTOM SELF-SUPPORTING TRIANGULAR CEMENT TERRAZZO TREAD

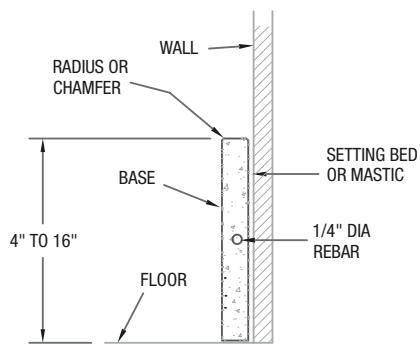

3/4" THICK FLAT CEMENT TERRAZZO BASE

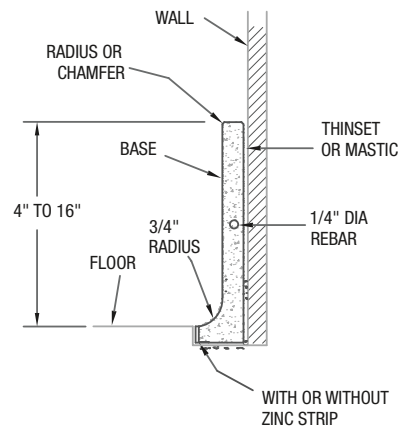

3/4" THICK COVERED CEMENT TERRAZZO BASE

- Compressive Strength (min) 4,000 psi Average
- Flexural Strength 600 psi Average
- Specifications subject to change

An earthy tone matrix combined with a variety of stone and shell aggregate lend to the warm charm of the River Run Series.

RIVER RUN SERIES

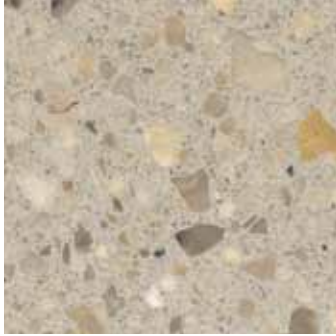

Spring Mist TZ01

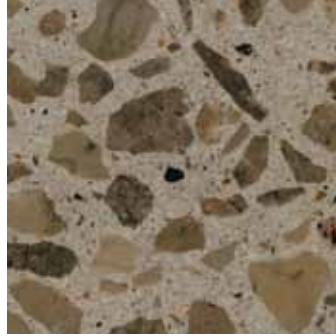

Outer Banks TZ02



Foggy Day TZ03

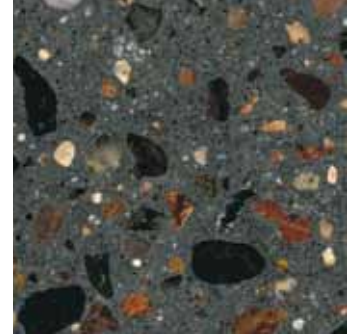

Deep Waters TZ04

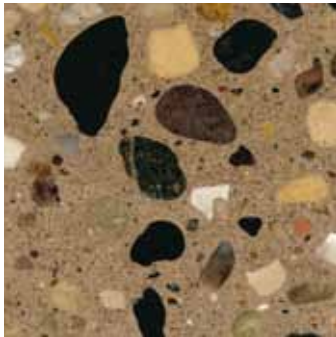

Driftwood TZ05

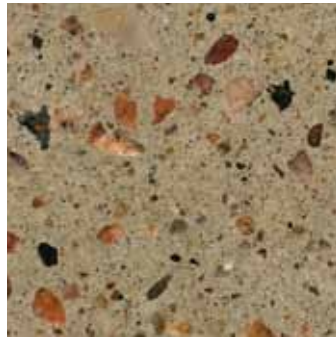

Tree Moss TZ06

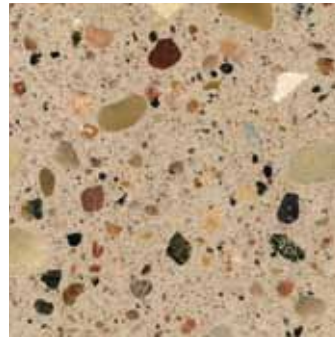

Coral Sands TZ07

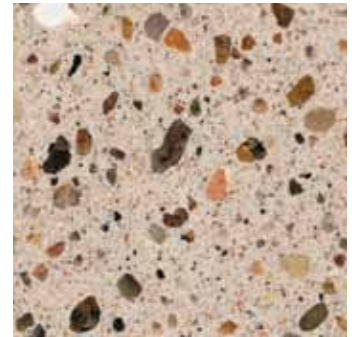

WRR-108

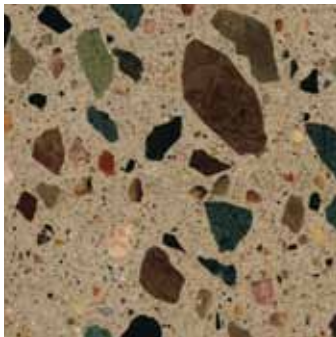

WRR-109

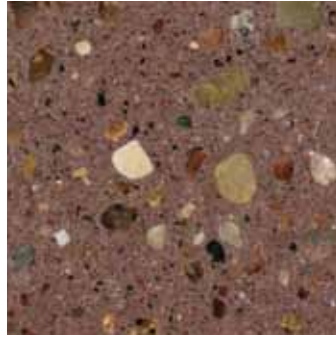

WRR-110

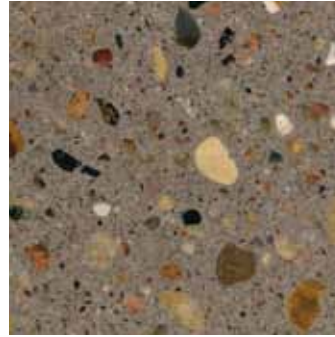

River Rock TZ08

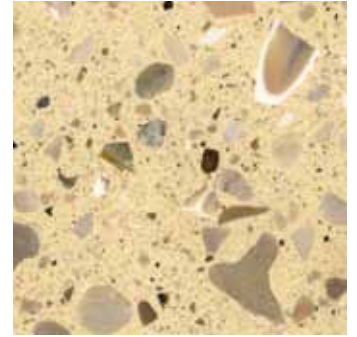

Sunny Shores TZ09



Shoreline TZ52

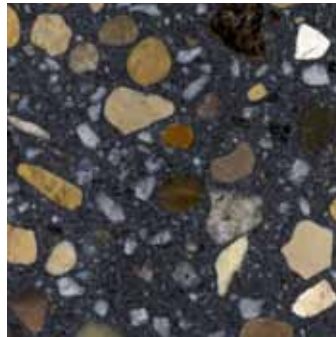

Sleepy Hollow TZ51

ATMOSPHERE SERIES

An impressive variety of matrix colors combined with sparkling aggregate, give any installation its own distinct *atmosphere*.



Socialite TZ67 - Fine Grain



Socialite TZ67 - Crystal Grain

Physical samples may differ from pictures shown. Actual sample approval required before production.

ATMOSPHERE SERIES

An impressive variety of matrix colors combined with sparkling aggregate, give any installation its own distinct *atmosphere*.

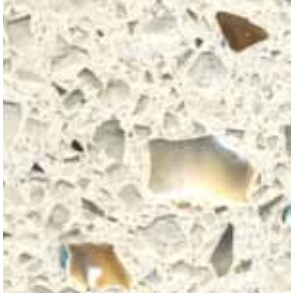

Radiance TZ68 - Pearlized Grain



Essence TZ65 - Pearlized Grain

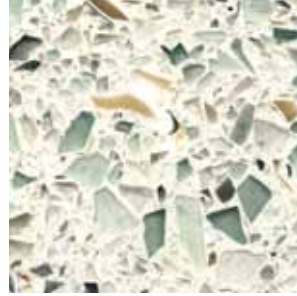

Brilliance TZ63 - Pearlized Grain



Ambience TZ54 - Crystal Grain



Optimistic TZ69 - Crystal Grain

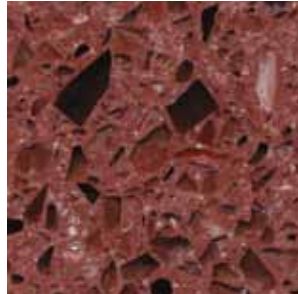

Ravishing TZ60 - Crystal Grain



Echelon TZ57 - Fine Grain



High Society TZ62 - Crystal Grain



Tropical TZ55 - Fine Grain

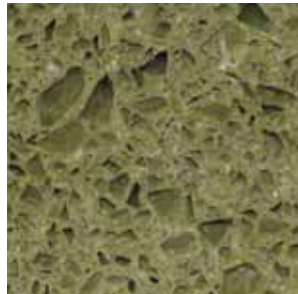

Tropical TZ55 - Crystal Grain



Envy TZ56 - Fine Grain

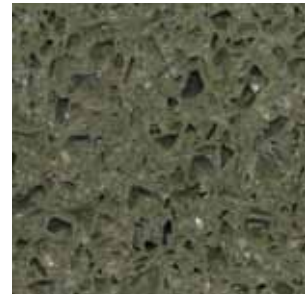

Envy TZ56 - Crystal Grain



Retreat TZ59 - Fine Grain



Retreat TZ59 - Crystal Grain



Analytical TZ53 - Fine Grain

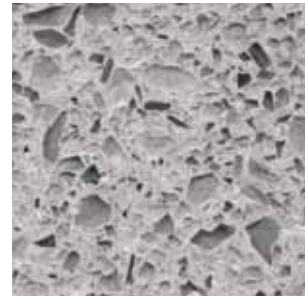

Analytical TZ53 - Crystal Grain

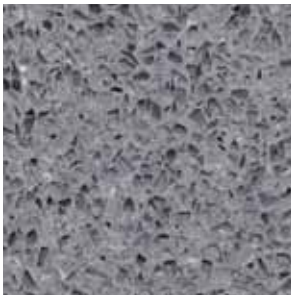

Infinity TZ58 - Fine Grain

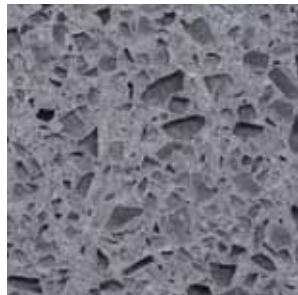

Infinity TZ58 - Crystal Grain

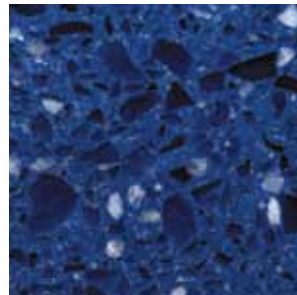

Attitude TZ64 - Crystal Grain

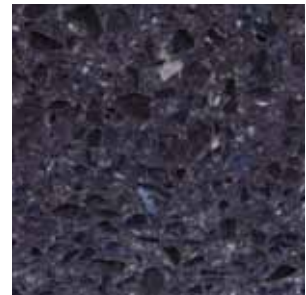

Mystical TZ61 - Crystal Grain

Physical samples may differ from pictures shown. Actual sample approval required before production.

The Traditional Series you have come to love in the variety you have come to expect.

TRADITIONAL SERIES



Parchment TZ22



Flax TZ23

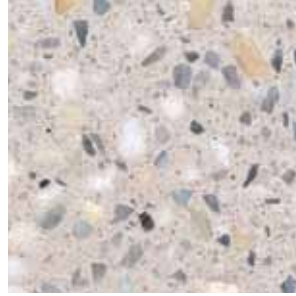

Jute TZ24

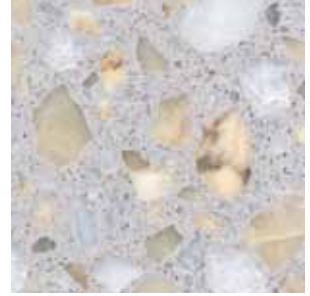

WT-753

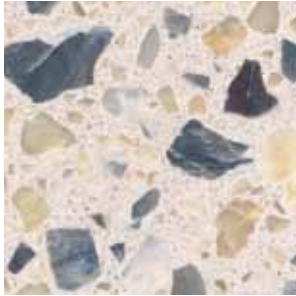

Morning Dove TZ25

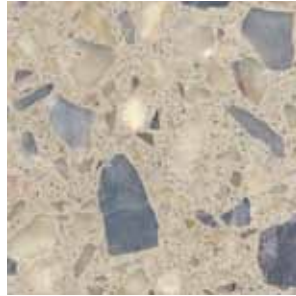

Sage TZ26

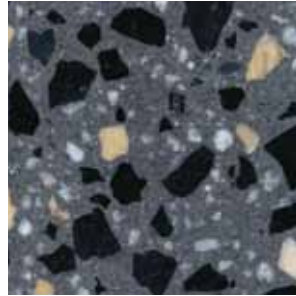

Peppercorn TZ27

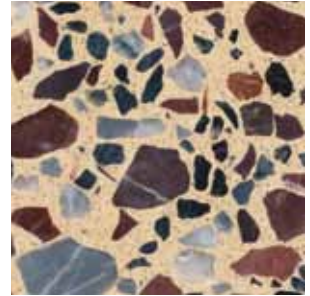

WT-757



WT-758

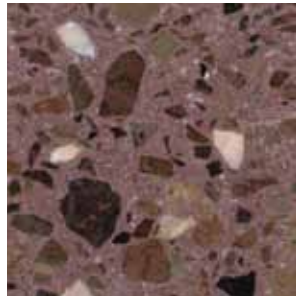

Cinnamon TZ28



Ginger TZ29

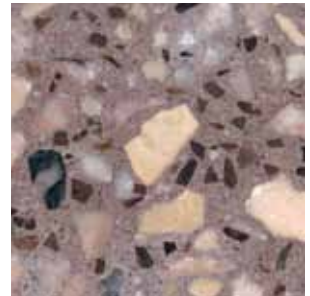

WT-761



WT-762

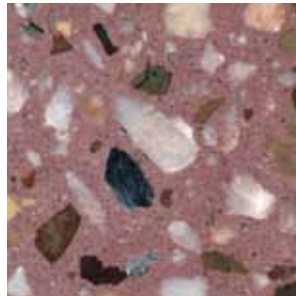

WT-763

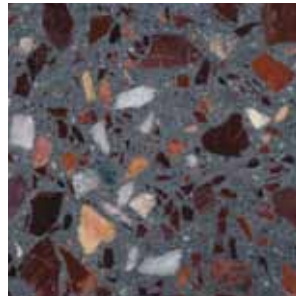

WT-764

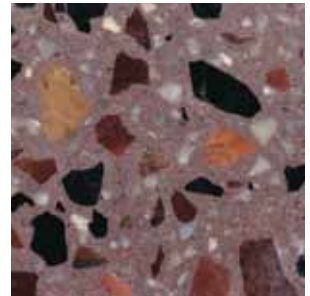

WT-765

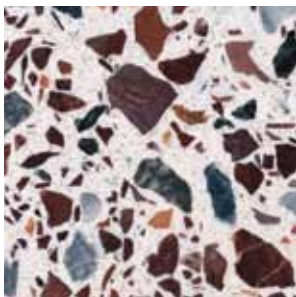

WT-766

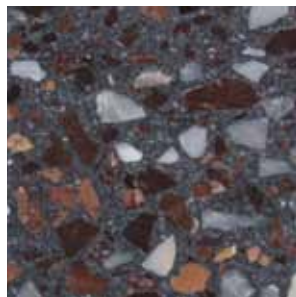

WT-767

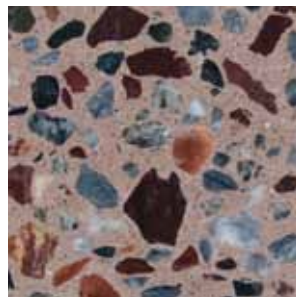

WT-768



Crushed Ice TZ30

Physical samples may differ from pictures shown. Actual sample approval required before production.

TRADITIONAL SERIES

The Traditional Series you have come to love in the variety you have come to expect.

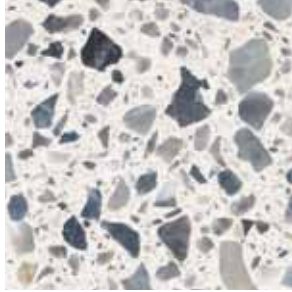

Cottage Gray TZ31



Oyster Shell TZ32

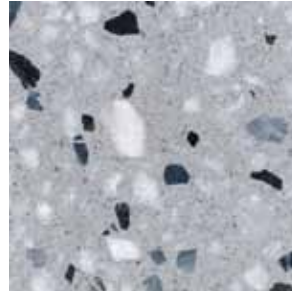

Turtle Dove TZ35

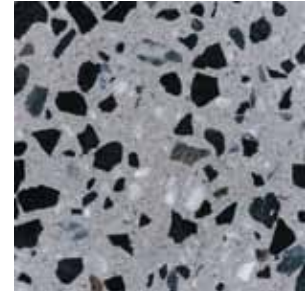

Graphite TZ33

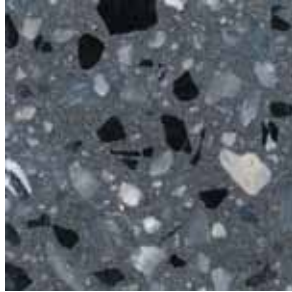

WT-774

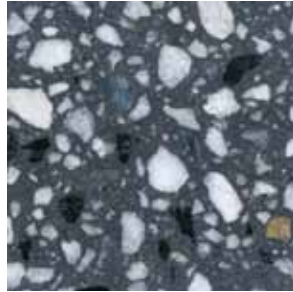

Night Owl TZ34

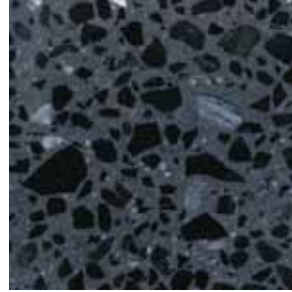

WT-776

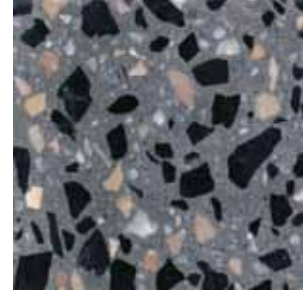

WT-777

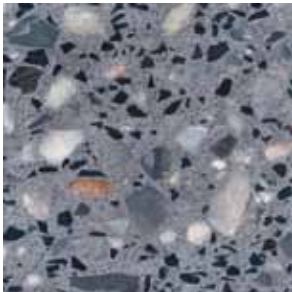

WT-778



WT-779



WT-780



Pink Champagne TZ36

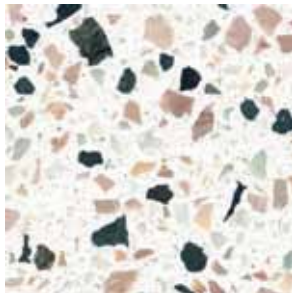

WT-782

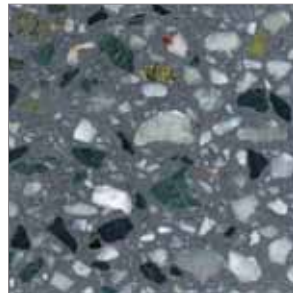

WT-783

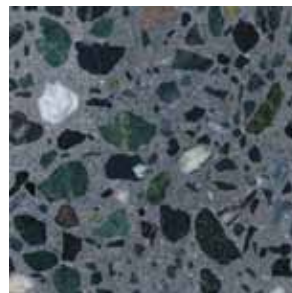

WT-784



Spearmint TZ37

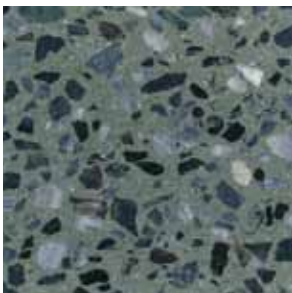

WT-786

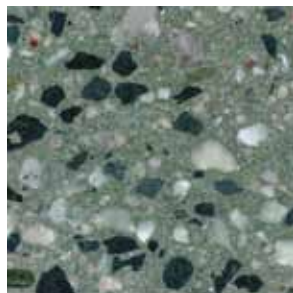

Mint Julep TZ38



Green Tea TZ39



Fresh Lime TZ40

Physical samples may differ from pictures shown. Actual sample approval required before production.

Both beautiful and environmentally friendly, this series contributes to your LEED® project credits.

RECYCLED GLASS SERIES



Swiss Alps TZ41

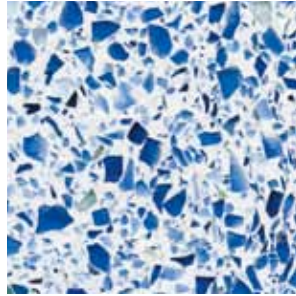

Blue Hawaii TZ42

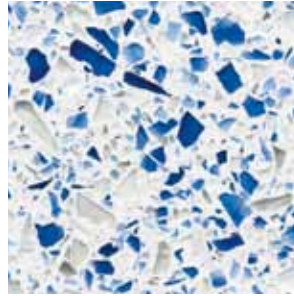

TG2-222

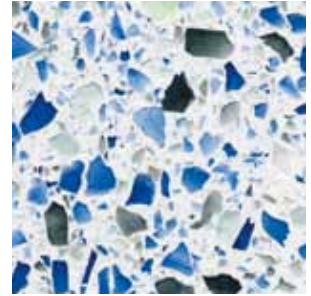

St. Tropez TZ43



TG2-224

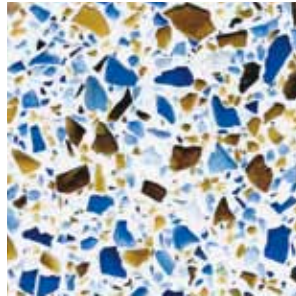

Cancun TZ44

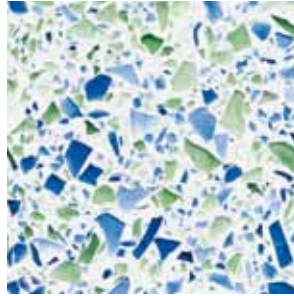

TG2-226



TG2-227

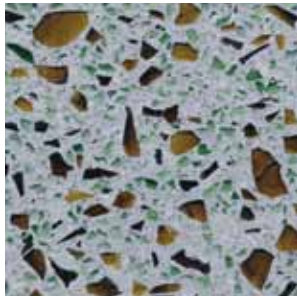

TG2-228

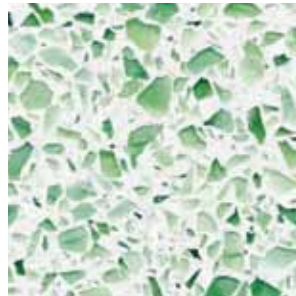

TG2-229

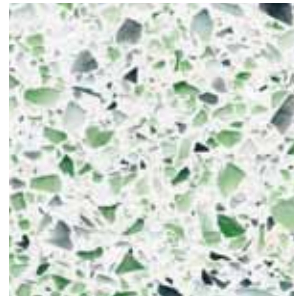

TG2-230



TG2-231



TG2-232



Key West TZ45

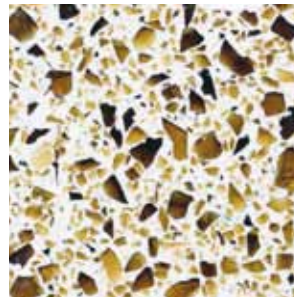

Morocco TZ46



Barbados TZ47

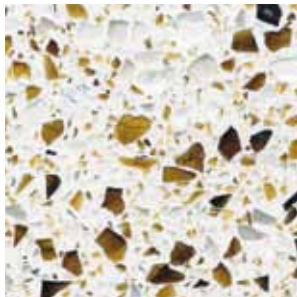

Riviera TZ48

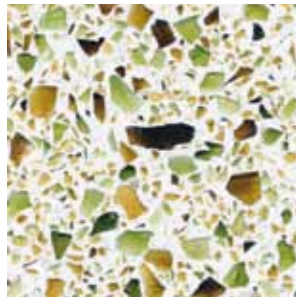

Amazon TZ49



TG2-238



TG2-239

Wausau Tile now produces sustainable glass aggregate terrazzo utilizing all recycled glass products; over 67% by weight.

RECYCLED GLASS SERIES

Both beautiful and environmentally friendly, this series contributes to your LEED® project credits.



TG2-240

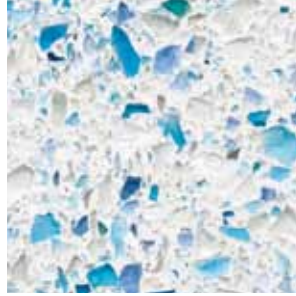

TG2-241



TG2-242

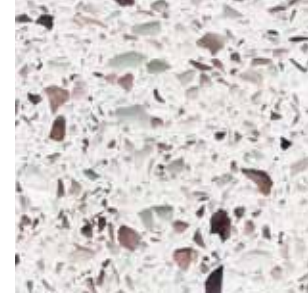

TG2-243

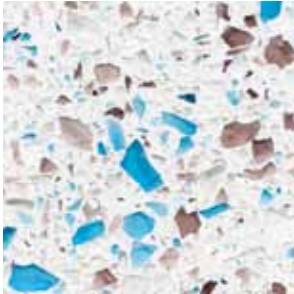

TG2-244



TG2-245

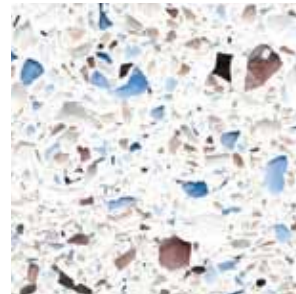

TG2-246



TG2-247



TG2-248

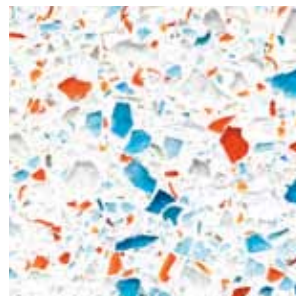

TG2-249



TG2-250



TG2-251



Rio TZ50



Wausau Tile now produces sustainable glass aggregate terrazzo utilizing all recycled glass products; over 67% by weight.

TT2000® SERIES EPOXY TERRAZZO

Self-Supporting Epoxy Flat Treads (ESS-30)
Hormel Institute • Austin, MN

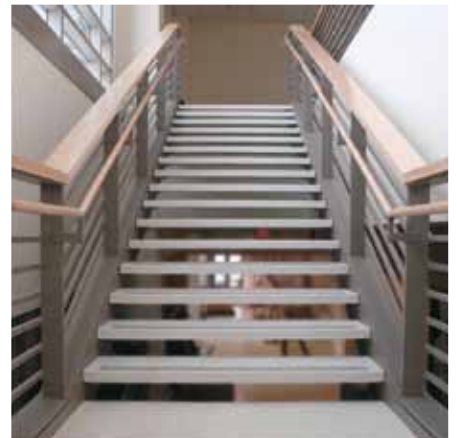

Advantages of Epoxy Terrazzo

STAIR TREADS TT2000® SERIES

- Vibrant colors
- Product thinner than concrete
- Lighter material equals less labor cost
- Resistant to stains
- Matches existing poured floors
- Can match non-terrazzo floors
- Self-supporting
- Quick, easy installation

New Technology • Thin Design • Durable Strength

EPOXY TERRAZZO



CUSTOM PRECAST TERRAZZO



EPOXY TERRAZZO DETAILS

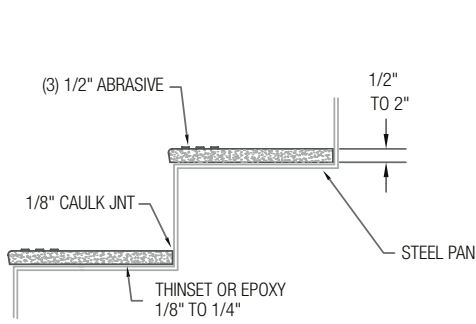

**TT2000™ SERIES
E-30 FLAT EPOXY TERRAZZO TREAD**

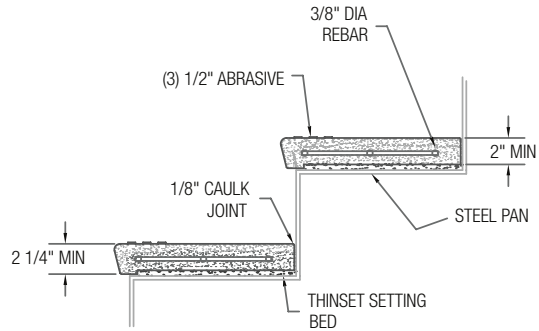

EC-30 FLAT EPOXY TERRAZZO TREAD

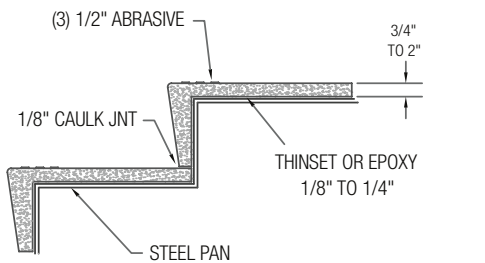

**TT2000™ SERIES
E-31 EPOXY TERRAZZO TREAD AND RISER**

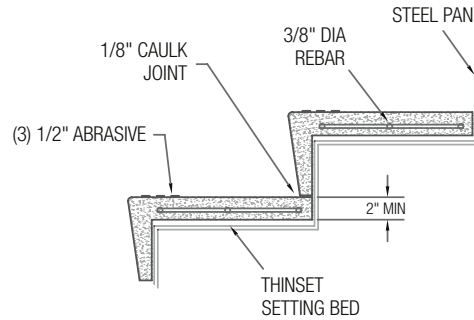

EC-31 EPOXY TERRAZZO TREAD & RISER

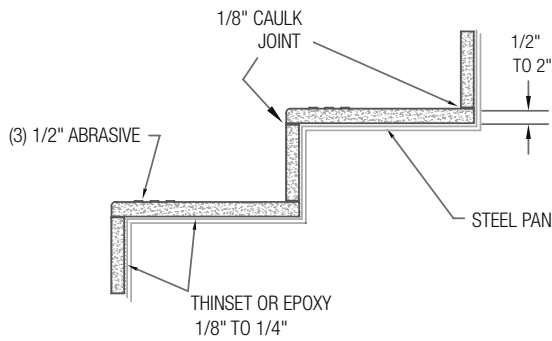

**TT2000™ SERIES
E-40 EPOXY TERRAZZO SEPARATE TREAD AND RISER**

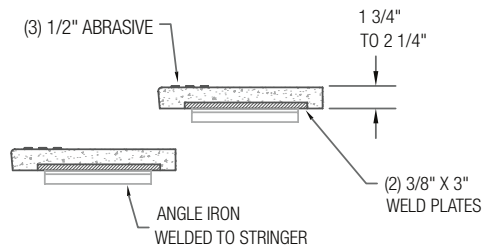

**TT2000™ SERIES
ESS-30 FLAT EPOXY TERRAZZO
SELF-SUPPORTING TREAD**

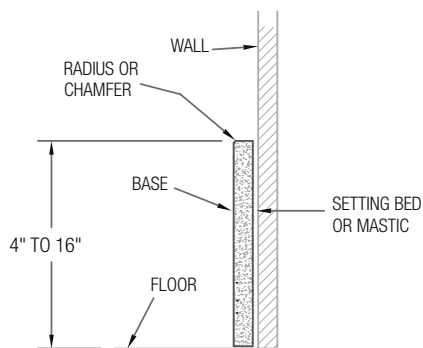

3/8" THICK FLAT EPOXY TERRAZZO BASE

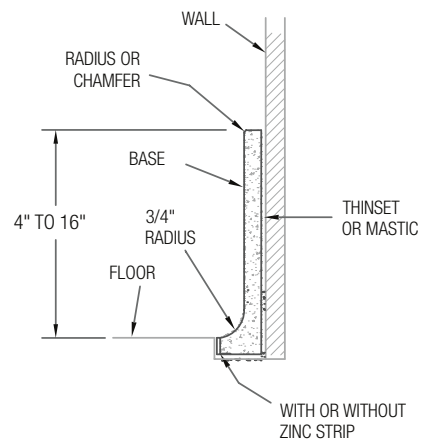

3/8" THICK COVERED EPOXY TERRAZZO BASE

• Compressive Strength (min) 5,000 psi Average • Flexural Strength 4,300 psi Average • Specifications subject to change

ADDITIONAL ARCHITECTURAL PRODUCTS



*Coordinate
your Precast
Terrazzo
with these
Complementing
Products*

- Concrete Pavers
- Terrazzo Tile and Slabs
- Precast Terrazzo
- Custom Precast Concrete
- Metal Site Furnishings
- Concrete Site Furnishings
- Plastic Site Furnishings
- Recycled Glass Products
- Recycled Porcelain Products



PO Box 1520, Wausau, WI 54402-1520
(800) 388-8728 • (715) 359-3121
Fax: (715) 359-7456
www.wausautile.com
E-mail: wtile@ausautile.com

PRSR STD
U.S. POSTAGE
PAID
U.M.S.

ARCHITECTURAL PRECAST TERRAZZO
by **WAUSAUTILE**

MADE IN
WAUSAU[®]

