

EIFS/STUCCO/ STONE VENEER SOLUTIONS

Exterior Insulation and Finish Systems (EIFS) currently comprise 30% of the commercial exterior wall market. With today's increased emphasis on energy efficiency, a building envelope incorporating an EIF System provides tremendous insulating value, while meeting or exceeding the demands of current regulatory requirements. Wind-lock® continues to support successful EIFS projects with superior products like Wind-Devil® fasteners and efficient tools for securing insulation board with adhesive and/or mechanical attachments, embedding fiberglass mesh and base coating. Wind-lock also offers a complete range of products for applying stucco, stone veneer and finish coatings.

6	FASTENING		WIND-DEVIL® 2 PAGE 6
14	HOT KNIVES		HOT KNIVES PAGE 14
17	KNIVES AND BLADES		
20	FOAM AND FOAM GUNS		FOAM2FOAM® PAGE 20
22	WATER MANAGEMENT		
26	CAULKING ACCESSORIES		
27	RASPS AND ACCESSORIES		
30	TROWELS		COMFORT-SOFT™ PAGE 30
38	FLOATS		FLOATS PAGE 38
41	DARBIES/HAWKS		
42	BUCKET ACCESSORIES		BUCKET DREDGER PAGE 42
43	MIXING AND SPRAYING TOOLS		
44	TAPES AND FILMS		RED STUCCO TAPE PAGE 44
46	FOAM CUTTING EQUIPMENT		
48	CLEAN-UP		
50	CHEMICALS		
51	STUCCO AND PLASTER ACCESSORIES		
52	STONE VENEER TOOLS		PERMALATH® PAGE 54
54	PERMALATH® GLASS FIBER LATH		
55	HOME SLICKER® AND BLOCKADE™		

HURRY UP IS NO HASSLE

With responsive service representatives, our *Stock to Dock* shipping guarantee and a customer sales team that knows all the availability and delivery details for our entire inventory, we can help you meet the tightest deadlines and toughest project cycle challenges. Want expedited shipping, custom orders, special handling or other delivery options to help you get what you need? No problem. And we offer accuracy and smart insights as well as quick delivery. The Wind-lock team can help you at any point in a project's life, from selection recommendations to field support and troubleshooting.





WIND-DEVIL® 2

EXCLUSIVE PRODUCT

*For Nearly 3 Decades,
Still The Most Trusted
Mechanical Fastening System!*



**Stock to Dock
Shipping Guarantee**

Products highlighted in yellow are guaranteed to ship within 24 hours or freight costs are **FREE!** Larger orders may require additional lead times. Call for details.

The industry-leading, two-inch diameter Wind-Devil® 2 is by far the most popular and technologically advanced EIFS mechanical fastening system on the market. The patented “bullseye” closure arms allow easy, efficient backing out of any screw, saving time and money.

The Wind-Devil® 2 is designed and engineered for use with polymer based (PB) EIFS (Exterior Insulation and Finish Systems). It allows the attachment of EPS insulation to a variety of substrates, including wood, lite metal, steel and masonry. Our witnessed, negative wind-load testing (ASTM-E330) continues to set the industry standard for attaching EIFS.

The Wind-Devil® 2 fastening system is engineered to be utilized in wood, lite metal, steel and masonry substrates and can be applied in any weather condition.

1. Wind-Devil® 2 Plates

Call your local distributor for pricing.

Part Code	Qty/Box	Description	Approx Wt/Box
WD-2PLATE	1000	Wind-Devil 2 Plates	10 lb
WD2-PK	500	Wind-Devil 2 Pack	5 lb

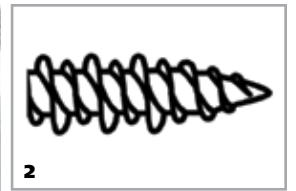

WIND-DEVIL® 2 FASTENERS SERIES SELECTION

Longer length fasteners are available. See Long-lock, page 8.

2. Wood and Lite Metal Series Assembled Fasteners (WLMT)

Assembled fastener and plate for use with dimensional lumber, plywood type sheathings and metal sidings, 20 to 26 gauge.

Part Code	Qty/Box	Insulation Thickness	Screw Size	Approx Wt/Box
WLMT-1	1000	1"	#7 x 1-5/8"	16 lb
WLMT-2	1000	1-1/2"	#8 x 2"	19 lb
WLMT-3	1000	2"	#8 x 2-1/2"	21 lb
WLMT-4	1000	2-1/2"	#8 x 3"	22 lb
WLMT-5	1000	3"	#8 x 4"	25 lb
WLMT-7	500	3-1/2"-4-1/2"	#10 x 5"	20 lb
WLMT-8	500	5"-5-1/2"	#10 x 6"	22 lb

Wood and Lite Metal Zinc Screw Series Assembled Fasteners (GWLMT)

Assembled fastener and plate for use with dimensional lumber, plywood type sheathings and metal sidings, 20 to 26 gauge, using our zinc plated UZW screws.

Part Code	Qty/Box	Insulation Thickness	Screw Size	Approx Wt/Box
GWLMT-1	1000	1"	#6 x 1-5/8"	16 lb
GWLMT-2	1000	1-1/2"	#6 x 2"	18 lb
GWLMT-3	1000	2"	#8 x 2-5/8"	21 lb
GWLMT-4	1000	2-1/2"	#8 x 3"	22 lb
GWLMT-5	1000	3"	#10 x 4"	25 lb

Wood Zinc Screw Series Assembled Fasteners (GWT)

Assembled fastener and plate for use with dimensional lumber and plywood type sheathings using our zinc plated UZW screws.

Part Code	Qty/Box	Insulation Thickness	Screw Size	Approx Wt/Box
GWT-1	1000	1"	#6 x 1-5/8"	16 lb
GWT-2	1000	1-1/2"	#7 x 2"	19 lb
GWT-3	1000	2"	#8 x 2-1/2"	21 lb
GWT-4	1000	2-1/2"	#8 x 3"	22 lb
GWT-5	1000	3"	#10 x 4"	25 lb

3. Steel Series Assembled Fasteners (ST)

Assembled fastener and plate for use with 12 to 20 gauge. Does not take into account sheathing thickness.

Part Code	Qty/Box	Insulation Thickness	Screw Size	Approx Wt/Box
ST-1	1000	1"	#6 x 1-5/8"	16 lb
ST-2	1000	1-1/2"	#6 x 2"	18 lb
ST-3	1000	2"	#8 x 2-5/8"	22 lb
ST-4	1000	2-1/2"	#8 x 3"	24 lb
ST-5	1000	3"	#10 x 4"	32 lb
ST-6	1000	3-1/2"-4"	#10 x 4-3/8"	34 lb
ST-7	500	4"-4-1/2"	#10 x 5"	20 lb
ST-8	500	5"-5-1/2"	#10 x 6"	23 lb
ST-9	500	6"-6-1/2"	#10 x 7"	26 lb
ST-10	500	7"-7-1/2"	#10 x 8"	27 lb

4. Masonry Series Assembled Fasteners (MT)

Assembled fastener and plate for use with concrete and other unit masonry. 5 drill bits per 1000 included.

Part Code	Qty/Box	Insulation Thickness	Screw Size	Approx Wt/Box
MT-1	1000	1" only	3/16" x 1-3/4"	21 lb
MT-2	1000	1-1/2"	3/16" x 2-1/4"	26 lb
MT-3	1000	2"	3/16" x 2-3/4"	26 lb
MT-4	1000	2-1/2"	3/16" x 3-1/4"	28 lb
MT-5	1000	3"	3/16" x 4"	31 lb

5. Masonry Expandable Series Assembled Fasteners (MET)

Assembled, expandable fastener and plate for use with concrete block, concrete and other unit masonry. Drill bit not included. For MET-1-MET-3 use bit M-S166; for MET-1-MET-7 use bit M-S1612. See page 11 for ordering information.

Part Code	Qty/Box	Insulation Thickness	Screw Size	Approx Wt/Box
MET-1	1000	1" only	3/16" x 2-1/4"	25 lb
MET-2	1000	1-1/2"	3/16" x 2-1/2"	26 lb
MET-3	1000	2"	3/16" x 3"	28 lb
MET-4	1000	3"	3/16" x 4"	30 lb
MET-5	1000	3-1/2"	3/16" x 4-1/2"	19 lb
MET-6	500	4"	#10 x 5"	21 lb
MET-7	500	5"	#10 x 6"	22 lb
MET-8	500	6"	#10 x 7"	25 lb
MET-9	500	7"	#10 x 8"	28 lb

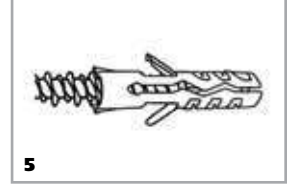
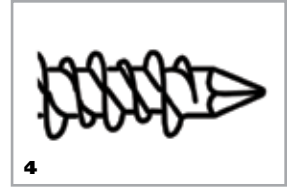
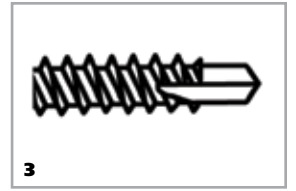

WIND-DEVIL® 2 TECHNICAL DATA

WIND-LOAD TEST DATA

Wind-Devil® 2

All measurements shown are ultimate pounds per foot.

EPS Thickness	Pattern A	Pattern B	Pattern C
1"	107	88	85
1-1/2"	130	114	103
2"	144	129	124

Witness test reports available.

GENERAL CORROSION DATA

Salt Spray (ASTM-B117)

Finish	Hours to Initial (%) Signs of Red Rust	Hours and Red Rust (%) at Test Conclusion
Phosphate and oil	24 (5% or less)	240 (90-100%)
.0003" electro zinc	48 (5% or less)	240 (75-100%)
.001" hot dip galvanized	98 (5% or less)	320 (75-100%)
Wind-lock® CCS Coating	192 (5% or less)	720 (50-100%)

FASTENER PULLOUTS

WLMT Series

Dimensional lumber/wood sheathings.

Penetration dimensional lumber	1/2"	3/4"	1"	1-1/4"	1-1/2"
Pullout strength	183	304	441	652	731

WLMT Series

Lite gauge metal siding.

Nominal gauge	26	25	22	20
Lite Metal pullout strength	*	178	244	277

*Consult Wind-lock® for pullout (through penetration 1/4" min.).

ST Series

Steel/steel studs.

Nominal gauge	24	22	20	18	16	14	12
Steel pullout strength	*	211	296	471	679	847	1225

*Consult Wind-lock® for pullout (through penetration 1/4" min.).

MT Series

Masonry.

Penetration	1"	1-1/4"	1-1/2"	1-3/4"
Concrete pullout strength	380	580	830	1090
Hollow block pullout strength	229	416 [†]	452 [†]	521 [†]

[†]Denotes solid material.

MET Series

Masonry expandable.

Concrete pullout strength	378
Hollow block pullout strength	333

Pullout strengths shown are ultimate values. An appropriate factor of safety must be applied by the user to obtain allowable limits for design. Masonry must be pre-drilled 1/2" deeper than fastener penetration. Hardness of masonry varies and may require a non-standard drill bit. Please consult Wind-lock® for assistance in proper drill bit size. Consult system manufacturer for specific requirements.

TYPICAL WIND-DEVIL® 2 FASTENING PATTERNS

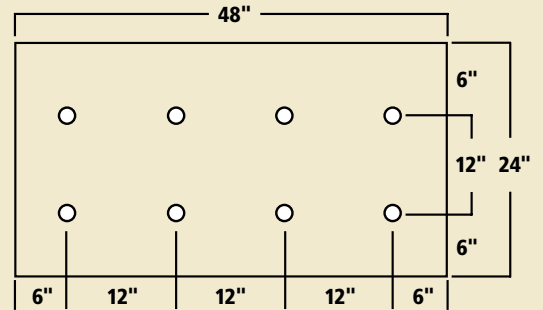

Pattern A

Wood sheathing, masonry and some metal sidings.

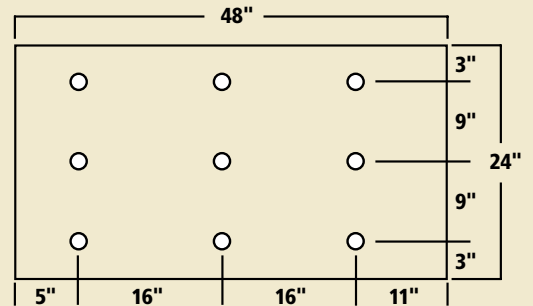

Pattern B

16" O.C. stud fastening pattern.

NOTE: For pattern "B" stud fastening over non-screwable sheathing, fastener spacing does not exceed 16" O.C. variable not to exceed 11".

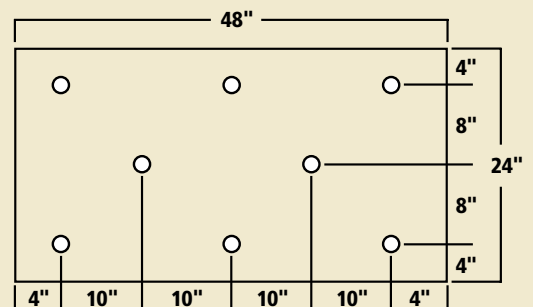

Pattern C

Wood sheathing, masonry and some metal sidings.

WIND-DEVIL® 2 SELECTION GUIDE

Insulation Thickness	Wood/Lite Metal Series**	Steel Series	Masonry Series
1"	WLMT-1	ST-1*	MT-1
1-1/2"	WLMT-2	ST-2*	MT-2
2"	WLMT-3	ST-3*	MT-3
2-1/2"	WLMT-4	ST-4*	MT-4
3"	WLMT-5	ST-5*	MT-5
3-1/2"	WLMT-7	ST-6*	For virtually any size fastener, contact Wind-lock® or refer to the Long-lock section, Page 8.
4"	WLMT-7	ST-7*	
4-1/2"	WLMT-7	ST-7*	
5"	WLMT-8	ST-8*	
5-1/2"	WLMT-8	ST-8*	

* Sizes are for direct application into steel and do not take into account the sheathing. For 1/2" and 5/8" sheathing, move fastener selection to next higher size.

** See page 5 for additional wood (GWT) and lite metal (GWLMT) fasteners.

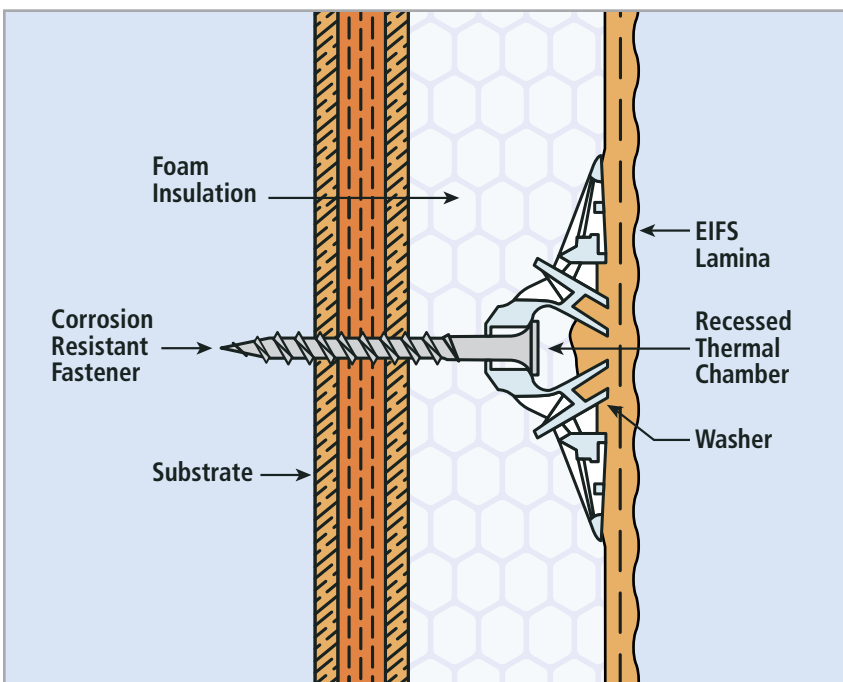

Why The Wind-Devil® 2 is Best!

- Comprehensive witness testing
- Over 20 years of proven performance
- EIFS industry approved
- Significant negative wind-load resistance
- Recessed thermal chamber helps prevent thermal bridging
- Patented closure arms allow for easy “backing” out
- Installation of the Wind-Devil® 2 compresses the foam under the washer forming a “gasket” around the fastener. This gasketing action diverts moisture from the fastener.



OTHER FASTENERS



1. ULP-302 Series Selection

The ULP-302 and ULP-402 are engineered to attach PermaLath® 17, 20 gauge stucco netting, as well as 2.5 and 3.4 metal lath (hard coat stucco systems). NOT for use with PB EIFS. For standard PB applications with the thermal recessed chamber, refer to Wind-Devil® 2 and Long-lock fasteners.

Engineered Features

- 1-3/4" diameter
- Made of high-grade polypropylene plastic
- Unique design allows plate to flatten out in application
- Large ribs stiffen plate, limit deflection
- 16 keyholes allow for mechanical locking of base coat
- Can be screw fastened, nailed or shot
- Engineered "flash" allows for pre-assembly of screw fasteners

Consult system manufacturer for specific requirements.

Wood/Lite Metal Series

Part Code	Qty/Box	Insulation Thickness	Screw Size	Approx Wt/Box
ULP-3WLM1	1000	3/4"	#7 x 1-5/8"	13 lb
ULP-3WLM2	1000	1"	#8 x 2"	15 lb
ULP-3WLM3	1000	1-1/2"	#8 x 2-1/2"	17 lb
ULP-3WLM4	1000	2"	#8 x 3"	19 lb
ULP-3WLM5	1000	3"	#8 x 4"	21 lb

Steel Series

Part Code	Qty/Box	Insulation Thickness	Screw Size	Approx Wt/Box
ULP-3S1	1000	3/4"	#6 x 1-5/8"	12 lb
ULP-3S2	1000	1"	#6 x 2"	14 lb
ULP-3S3	1000	1-1/2"	#8 x 2-5/8"	18 lb
ULP-3S4	1000	2"	#8 x 3"	19 lb
ULP-3S5	1000	3"	#10 x 4"	27 lb

2. ULP-302 Plate

Part Code	Qty/Box	Description	Approx Wt/Box
ULP-302	1000	Plates	6 lb

3. ULP-402 Series Selection

Engineered Features

- 1-3/4" diameter
- Made of high-grade polypropylene plastic
- Pre-spotting central stem/tab allows for quick and easy pre-spotting into insulation board
- Large ribs stiffen plate, limit deflection
- 16 keyholes allow for mechanical locking of base coat
- The ULP-402 is unassembled and can be utilized with Wind-lock® highly coated exterior fasteners

Consult system manufacturer for specific requirements.

Part Code	Qty/Box	Approx Wt/Box
ULP-402	1000	6 lb

4. Long-lock Fasteners

Use these for all of your thick foam fastening needs, such as: cornice details, arches, columns, custom parapet shapes and quoins. All fasteners come fully assembled.

Engineered Features

- 1-3/4" diameter
- Finger closure and recessed fastener chamber
- Utilized for thicker insulation

Consult system manufacturer for specific requirements.

WLM—Wood/Lite Metal/Masonry Screws

Hardness of masonry varies and may require a non-standard drill bit. Please consult Wind-lock® for assistance in proper drill bit size. Includes one drill bit per 200 pieces.

Part Code	Qty/Box	Insulation Thickness	Screw Size	Approx Wt/Box
WLM-7	100	4"	#14 x 5"	5 lb
WLM-8	100	5"	#14 x 6"	5 lb
WLM-9	100	6"	#14 x 7"	6 lb
WLM-10	100	7"	#14 x 8"	7 lb
WLM-11	100	8"	#14 x 9"	8 lb
WLM-12	100	9"	#14 x 10"	8 lb
WLM-13	100	10"	#14 x 11"	9 lb
WLM-14	100	11"	#14 x 12"	10 lb
WLM-15	100	12"-13"	#14 x 14"	12 lb

For even longer fasteners, please contact Wind-lock®



Stock to Dock Shipping Guarantee

Products highlighted in yellow are guaranteed to ship within 24 hours or freight costs are **FREE!** Larger orders may require additional lead times. Call for details.

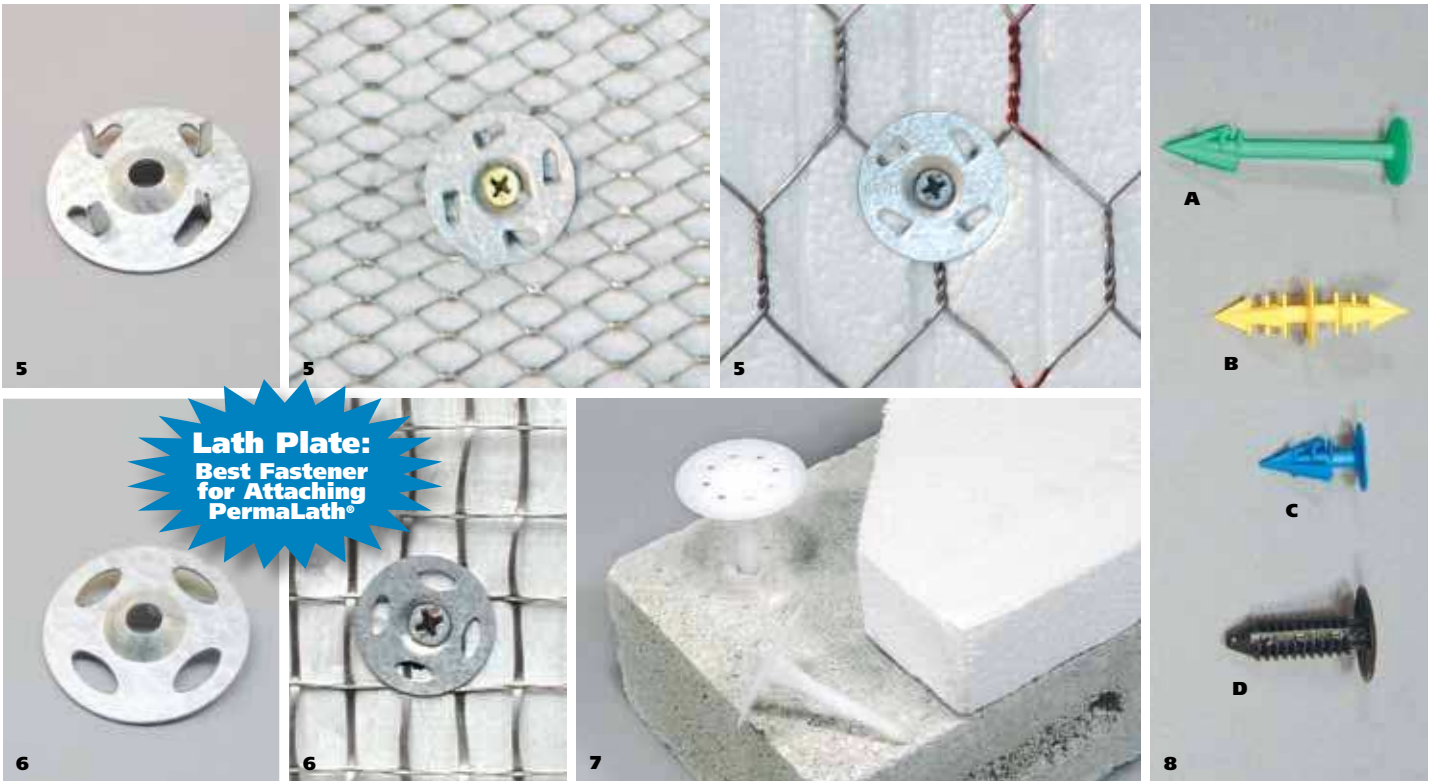

**Lath Plate:
Best Fastener
for Attaching
PermaLath®**

5. Lath-Lock

Designed to be used with Polymer Modified (PM) Hard Coat EIFS, insulated stucco systems, stucco systems utilizing expanded metal lath or stucco wire over rigid insulations.

Engineered Features

- 1-1/4" diameter, G-90 galvanized steel
- Flat profile
- Positive attachment
- Tabs reduce spin in insulation board
- Reversed arm creates non-stacking plate
- Recessed center chamber allows for flush seating of fastener
- Turned tabs allow for pre-spotting
- Smooth edges
- Can be screw fastened, nailed or shot

Consult system manufacturer for specific requirements.

Part Code	Qty/Box	Approx Wt/Box
LATH-LOCK	1000	9 lb

6. Lath-Plate (Legless)

Legless Lath-Plate is perfect for stone veneer and thin coat stucco utilizing PermaLath®.

Engineered Features

- 1-1/4" diameter, G-90 galvanized steel
- Flat profile
- Positive attachment
- Recessed center chamber allows for flush seating of fastener
- Smooth edges
- Can be screw fastened, nailed or shot

Consult system manufacturer for specific requirements.

Part Code	Qty/Box	Approx Wt/Box
LATH-PLATE (Legless)	1000	9 lb

7. Congrip Masonry Fasteners

Made of polypropylene with keyholes for locking in the base coat. Simply drill a pilot hole and hammer into the concrete. Requires 5/16" drill bit.

Part Code	Qty/Box	Insulation Thickness	Description	Approx Wt/Box
W-MCG0	250	3/4"-1"	2" Masonry Walgrip	4 lb
W-MCG1	250	1-1/2"	2-3/4" Masonry Walgrip	4 lb
W-MCG2	250	2"	3-1/2" Masonry Walgrip	5 lb

Longer sizes available, call for details.

8. Foam Tacs

Temporary fastening system used in conjunction with adhesive attachment of stucco trims and accessories.

Part Code	Qty/Bag	Description	Approx Wt/Bag
A ARROW-TAC	250	1-3/4" Arrow Foam Tac	1 lb
B INSUL-TAC	250	1-1/2" Insul Foam Tac	1 lb
C TRIM-TAC	250	3/4" Trim Foam Tac	1 lb
D M-TT1	1000	1" Trim Tab	2 lb
D M-TT158	1000	1-5/8" Trim Tab	3 lb

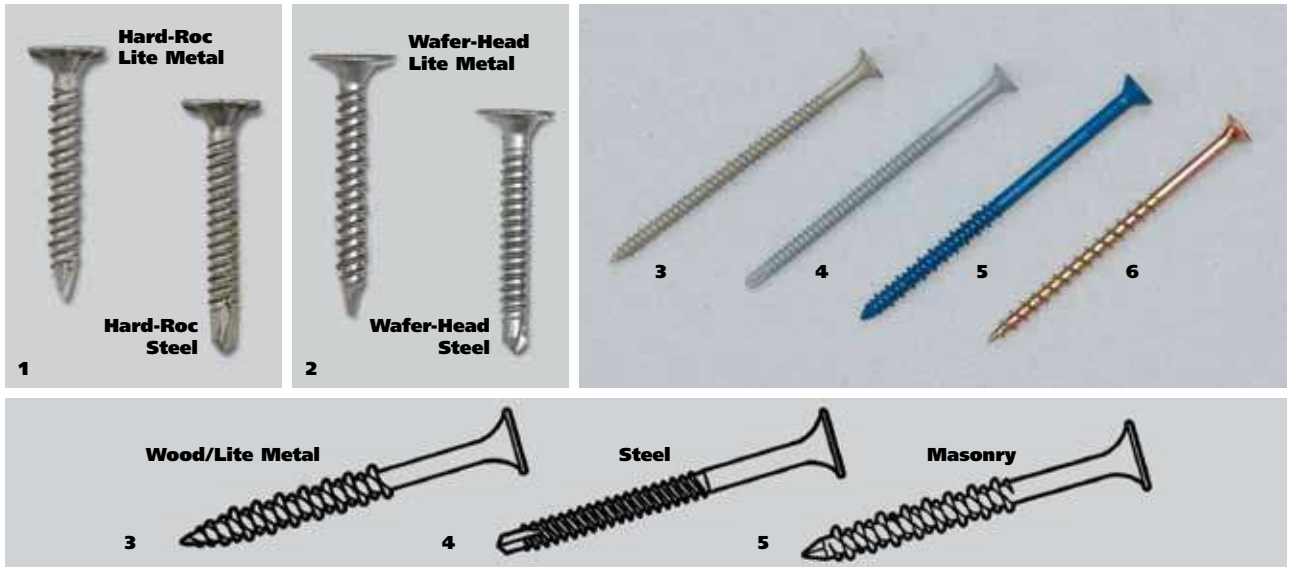

SCREWS

All wood/lite metal and steel fasteners are self-tapping. All screws except for the economy wood fasteners (UZW) are highly coated, meeting the Wind-lock® Corrosion Coating Standard.

1. Hard-Roc Sheathing Fasteners (F-HR)

Part Code	Qty/Box	Screw Size	Approx Wt/Box
F-HR114	1000	#9 x 1-1/4"	6 lb
F-HR158	1000	#9 x 1-5/8"	7 lb
F-HR114S	1000	#8 x 1-1/4"	6 lb
F-HR158S	1000	#8 x 1-5/8"	7 lb

2. Wafer-Head Sheathing Fasteners (F-WH)

Part Code	Qty/Box	Screw Size	Approx Wt/Box
F-WH114	1000	#8 x 1-1/4"	6 lb
F-WH158	1000	#8 x 1-5/8"	7 lb
F-WH114S	1000	#10 x 1-1/4"	6 lb
F-WH158S	1000	#8 x 1-5/8"	7 lb

3. Wood/Lite Metal Fasteners (UWLM)

Part Code	Qty/Box	Screw Size	Approx Wt/Box
UWLM-1	1000	#7 x 1-5/8"	6 lb
UWLM-2	1000	#8 x 2"	8 lb
UWLM-3	1000	#8 x 2-1/2"	9 lb
UWLM-4	1000	#8 x 3"	11 lb
UWLM-5	1000	#8 x 4"	13 lb
UWLM-7	1000	#10 x 5"	22 lb
UWLM-8	1000	#10 x 6"	27 lb

4. Steel Fasteners (US)

Part Code	Qty/Box	Screw Size	Approx Wt/Box
US-1	1000	#6 x 1-5/8"	5 lb
US-2	1000	#6 x 2"	8 lb
US-3	1000	#8 x 2-5/8"	11 lb
US-4	1000	#8 x 3"	13 lb
US-5	1000	#10 x 4"	22 lb
US-6	1000	#10 x 4-3/8"	23 lb
US-7	1000	#10 x 5"	26 lb
US-8	1000	#10 x 6"	32 lb

Longer sizes available, call for details.

5. Tapcon® Masonry Fasteners (UM)

Includes 5 drill bits per 1000 pieces.

Part Code	Qty/Box	Screw Size	Approx Wt/Box
UM-1	1000	3/16" x 1-3/4"	10 lb
UM-2	1000	3/16" x 2-1/4"	12 lb
UM-3	1000	3/16" x 2-3/4"	15 lb
UM-4	1000	3/16" x 3-1/4"	17 lb
UM-5	1000	3/16" x 4"	21 lb

Longer sizes available, call for details.

6. Economy Wood Fasteners (UZW)

Zinc coated for use with dimensional lumber and plywood type sheathings.

Part Code	Qty/Box	Screw Size	Approx Wt/Box
UZW-1	1000	#6 x 1-5/8"	6 lb
UZW-2	1000	#7 x 2"	8 lb
UZW-3	1000	#8 x 2-1/2"	9 lb
UZW-4	1000	#8 x 3"	11 lb
UZW-5	1000	#10 x 4"	23 lb

7. Economy Wood and Lite Metal Fasteners (UZWLM)

Zinc coated for use with dimensional lumber, plywood type sheathings and metal sidings, 20 to 26 gauge.

Part Code	Qty/Box	Screw Size	Approx Wt/Box
NS UZWLM-1	1000	#6 x 1-5/8"	6 lb
NS UZWLM-2	1000	#6 x 2"	8 lb
NS UZWLM-3	1000	#8 x 2-5/8"	9 lb
NS UZWLM-4	1000	#8 x 3"	11 lb
NS UZWLM-5	1000	#10 x 4"	23 lb

NS=Not shown.



1

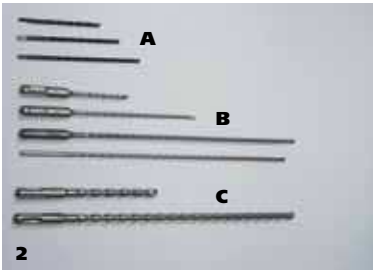

2



3

FASTENING TOOLS

1. Universal Depth Stop

For EIFS applications.

- Works with virtually any screw gun or drill
- Adjustable
- Prevents overdrive
- Provides consistent seating depth
- Hardened steel
- Sealed bearing

Part Code	Description	Contr Price	Approx Wt
M-UNIV	Universal Depth Stop	\$49.95	1 lb

2. Masonry Drill Bits

A For use with hammer drills. Pre-drill pilot holes when working with masonry substrates.

B and **C** SCS carbide-tipped drill bits are specifically designed for Wind-lock® screw-in masonry anchors and used with rotary hammer drills.

Part Code	Bit Size	Usable Length	Usage	Pcs/Pk	Contr Price	Approx Wt
A M-PKMDB35	5/32" x 3-1/2"	2"	MT-1 only	10	\$41.00	1 lb
A M-PKMDB45	5/32" x 4-1/2"	2-3/4"	MT-1-MT-3	10	\$48.00	1 lb
A M-PKMDB55	5/32" x 5-1/2"	3-1/2"	MT-1-MT-5	10	\$53.00	1 lb
B M-S324	5/32" x 4"	2"	MT-1 only	1	\$9.45	1 lb
B M-S327	5/32" x 7"	5"	MT-1-MT-5	1	\$9.85	1 lb
B 5000025	3/16" x 14"	12"	MT-1-MT-12	1	\$16.00	1 lb
B 5000026	3/16" x 12" Straight Shank	12"	MT-1-MT-12	1	\$10.00	1 lb
C M-S166	5/16" x 6"	4"	MET-1-MET-3	1	\$11.95	1 lb
C M-S1612	5/16" x 12"	10"	MET-1-MET-7	1	\$19.20	1 lb

3. Hammer Tackers and Staples

Use for fast attachment of building wraps. Single-handed grip for easy operations. Reliable and durable with no loose parts.

Tackers

Part Code	Description	Contr Price/Pc	Approx Wt/Box
T-HTRR19	Rapid R19	\$26.95	1 lb
T-HTRR11	Rapid R11	\$47.40	1 lb

Staples

Part Code	Description	Contr Price/Pc	Approx Wt/Box
T-STHT19	R19 1/4" staple Box 5,000	\$3.15	1 lb
T-STHT50	R19 1/4" staple Case/48 boxes	\$145.00	1 lb
T-STHT1/4	1/4" staples Box 5,000	\$3.85	1 lb
T-STHT3/8	3/8" staples Box 5,000	\$5.30	1 lb
T-STHT5/16	5/16" staples Box 5,000	\$5.15	1 lb

Kits

Part Code	Description	Contr Price/Pc	Approx Wt/Box
T-KHTR19	R19 Tacker and 1 box of 1/4" staples	\$28.95	2 lb
T-KHTR11	R11 Tacker and 2 boxes of staples 1/4" and 3/8"	\$53.50	3 lb

Industry Exclusive:
Now with a 3 year warranty.



1



2



3

NEW!

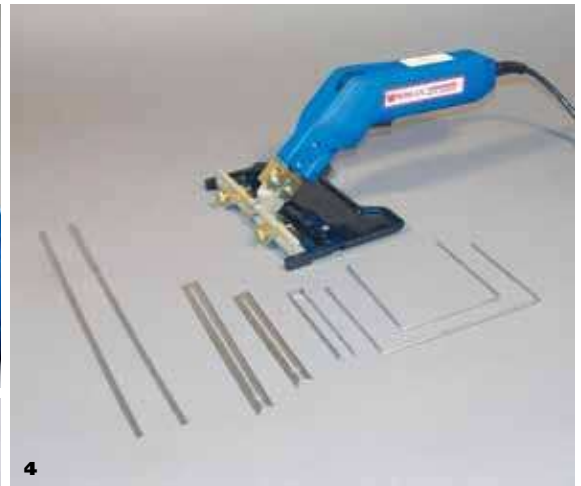

4



5

2-QC HOT KNIFE, KITS AND ACCESSORIES

EXCLUSIVE PRODUCT



Stock to Dock Shipping Guarantee

Products highlighted in yellow are guaranteed to ship within 24 hours or freight costs are **FREE!** Larger orders may require additional lead times. Call for details.

1. 2-QC Knife

Cuts foam clean with no bead dust. Handle stays cool.

KIT INCLUDES: 2-QC Hot Knife and 4" straight blade.

Part Code	Description	Contr Price	Approx Wt
2-QC	Hot Knife Tool Kit	\$250.85	2 lb
2-BQC	Hot Knife Tool Kit and Bag	\$280.05	5 lb

2. 2-QC Hot Knife Kit

For use with Groove Blades.

KIT INCLUDES: 2-QC Hot Knife, 6" sled, 4" straight blade and 2 pieces of 12" flat blade material.

Part Code	Description	Contr Price	Approx Wt
2-QCKIT	Hot Knife Kit with 6" Sled	\$350.95	3 lb
2-BQCKIT	Hot Knife Tool Kit with 6" Sled and Bag	\$379.95	5 lb

3. Ultimate EIFS Kit **NEW!**

Our most complete Hot Knife Kit.

KIT INCLUDES: 2 QC Hot Knife, 6" sled, 4" straight blade, 3/4" x 3/4" V Groove kit, UGZ® hand rasp, Insul-Knife™ with sharpener, 3 cans of F2F® foam gun and can of cleaner, rubber coated gloves and canvas tool bag.

Part Code	Description	Contr Price	Approx Wt
2-UEIFSKIT	Ultimate EIFS Kit	\$525.95	22 lb

4. ICF Kit

Great starter kit.

KIT INCLUDES: 2-QC Hot Knife, 6" sled, 1/2" x 3" square blade, 4" and 6" straight blades, single and double electrical box cutter blades, 2 pieces of 12" flat blade material.

Part Code	Description	Contr Price	Approx Wt
2-ICFKIT	Concrete Forms Kit	\$364.75	3 lb
2-BICFKIT	Concrete Forms Kit (page 13)	\$393.55	5 lb

5. EPS Board Beveler

Part Code	Description	Contr Price	Approx Wt
Q-EPSBB	45° Angle Attachment	\$39.95	2 lb

6. 2-QC Knife Straight Blades

Part Code	Description	Contr Price	Approx Wt
NS Q-SB2	2" Straight Blade 2 pack	\$20.00	1 lb
NS Q-SB4	4" Straight Blade 2 pack	\$24.00	1 lb
NS Q-SB6	6" Straight Blade 2 pack	\$28.00	1 lb

NS=Not shown.
Blade shown in photo number 1.

Buy the Kit and Save!

Also see Applicator Tool Bag Kit on pg. 32.

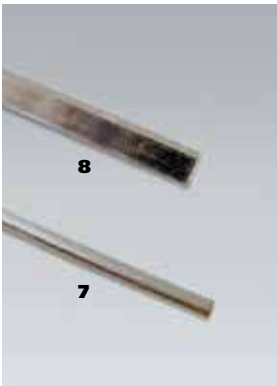

7. Round Wire Blade Material

Part Code	Description	Contr Price	Approx Wt
Q-RBM243	24" Round Wire Blade Material 3 pack	\$25.95	1 lb

8. Flat Blade Material

Part Code	Description	Contr Price	Approx Wt
Q-SBM123	12" Flat Blade Material 3 pack	\$18.00	1 lb
Q-SBM128	12" Flat Blade Material 8 pack	\$48.00	1 lb
Q-SBMR12	12" Flat Blade Material Roll	\$66.00	1 lb
Q-SBMR24	24" Flat Blade Material Roll	\$119.95	1 lb

9. Hard Wire Benders

Part Code	Description	Contr Price	Approx Wt
W-HWB	Hard Wire Benders	\$15.75	1 lb

10. Hard Wire Cutter

Part Code	Description	Contr Price	Approx Wt
T-HWC63	Hard Wire Cutter	\$57.25	1 lb

11. Replacement Blade Holder Parts

Thumbscrews make blade changing easier.

KIT INCLUDES: Brass plates and 2 thumbscrews.

Sled not included.

Part Code	Description	Contr Price	Approx Wt
2-QCRK	Brass Blade Holder Replacement Parts	\$7.95	1 lb
Q-SLED6RK	Brass Sled Holder Replacement Parts	\$19.50	1 lb

12. Step-Up and Down Transformer 120/220V

International converter.

Part Code	Description	Contr Price	Approx Wt
I-TS4033	Transformer Voltage Converter 120/220V	\$29.95	7 lb

PROPER USE OF THE WIND-LOCK® QC HOT KNIFE



1. How to use the Wind-lock® QC Hot Knife.



4. The versatile blade holders can accept a wide variety of blades and attachments. The QS-50 is shown. 1/2" x 3".



2. The spring-loaded on/off trigger offers you instant power.



5. The blade holders can accept a wide variety of blades and attachments. The Q-SLED6 shown.



3. The dial power control located on the top is for adjustable blade heat control.

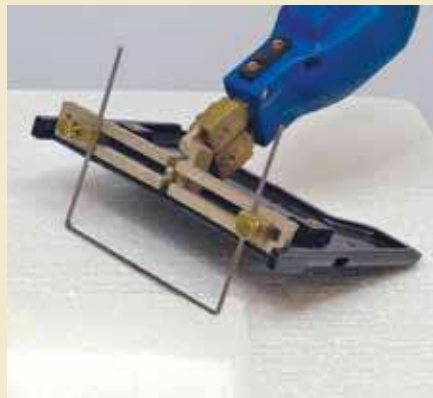

6. The Q-SLED6's adjustable blade depth is used for plunge or scooping cuts. The Q-EBX4 (Electrical Box Cutter) is shown.

*Want more cutting power?
Same techniques apply to the
Wind-lock® Super Groover.™
(See page 60)*

Always disconnect power before changing blade.

BEND YOUR OWN BLADES





1 A

B

C



1 D

E



2 F

G



2 H

I

J

K



3 L

M



3 N

O

P

Q

S



4



5

KNIVES AND BLADES

1. OLFA

Part Code	Description	Contr Price	Approx Wt
A I-HDUK	Utility Knife—OLFA, Non-Slip, Heavy Duty 1" Blade	\$16.99	1 lb
B I-RHDK	Utility Knife—OLFA, Rubber, Heavy Duty 1" Blade	\$19.99	1 lb
C I-UK	Utility Knife—OLFA, Plastic Knife 3/4" Blade	\$9.45	1 lb
D I-S10PK	Utility Blade—Solid 3/4" Blade, 10 pack	\$9.40	1 lb
E I-HD20PK	Utility Blade—Heavy Duty 1" Blade, 20 pack	\$28.49	1 lb

2. Tajima

Part Code	Description	Contr Price	Approx Wt
F I-TJHDK	Utility Knife—Tajima, 1" Blade, Rock Hard	\$9.75	1 lb
G I-TJUK	Utility Knife—Tajima, 3/4" Wide Blade	\$7.50	1 lb
H I-TJHD20PK	Utility Blade—Tajima, Rock Hard Breakaway 1' Wide Blade	\$18.50	1 lb
I I-TJHD5PK	Utility Blade—Tajima, Rock Hard Breakaway 1' Wide Blade	\$6.90	1 lb
J I-TJ10PK	Utility Blade—Tajima, Endura Breakaway 3/4" Wide Blade, 10 pack	\$6.00	1 lb
K I-TJ50PK	Utility Blade—Tajima, Endura Breakaway 3/4" Wide Blade, 50 pack	\$18.00	3 lb

3. KDS

Part Code	Description	Contr Price	Approx Wt
L I-JBH12	Utility Knife—KDS, Plastic, Heavy Duty	\$8.36	1 lb
M I-LUK19	Utility Knife—KDS, Plastic	\$6.05	1 lb
N I-SHD10PK	Utility Blade—Heavy Duty 1" Blade, 10 pack	\$12.95	1 lb
O I-HD50PK	Utility Blade—Heavy Duty 1" Blade, 50 pack	\$59.50	3 lb
P I-10PK	Utility Blade—Black Breakaway Blade, 10 pack	\$7.50	1 lb
Q I-HD10PK	Utility Blade—Heavy Duty 1" Blade, 10 pack	\$12.75	1 lb
NS R I-HD5PK	Utility Blade—Heavy Duty 1" Blade, 5 pack	\$6.50	1 lb
S I-50PK	Utility Blade—Breakaway Blade, 50 pack	\$35.00	3 lb

NS=Not shown.

4. Ansell Cut Protection Glove

Combining comfort plus the ultimate in cut protection and dexterity—all in one glove—this is the construction glove to be wearing when handling rough, sharp or jagged materials.

Part Code	Description	Size	Contr Price
W-KEVGMD	Blue Kevlar with Stainless Steel Cut Resistant Gloves	Medium	\$20.95
W-KEVGLG	Blue Kevlar with Stainless Steel Cut Resistant Gloves	Large	\$20.95

5. Insul-Knife™

Insul-Knife™ is one of those time-saving tools that you will wonder how you ever lived without. It is perfect for easily cutting all type of insulations including: EPS foam, fiberglass, sponge foam and cotton fiber. It is an excellent tool for trimming unwanted excess foam insulation after it expands and cures.

Part Code	Description	Contr Price
W-INSULKIT	Multipurpose Insulation Kit (Knife and Sharpener)	\$42.95
W-INSULS	Insulation Knife Sharpener	\$10.99

Kit Includes Groove Tool Handle

AESTHETIC GROOVE KITS

To add aesthetic grooves to your EIFS project you will need a 2-QC Hot Knife with the Q-SLED6 groove sled adapter and an aesthetic groove kit. The aesthetic groove kit includes the groove tool handle, three blades and the sleds necessary to complete grooves to the finished dimensions. The dimensions below represent the finished grooves when using a PB EIFS system. Other kits, additional sizes and custom sizes are available, call for details.



Stock to Dock Shipping Guarantee

Products highlighted in yellow are guaranteed to ship within 24 hours or freight costs are **FREE!** Larger orders may require additional lead times. Call for details.

V Groove

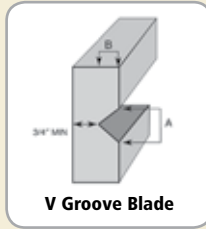

V Groove Tool, Blades and Sled Kits

Part Code	Dimensions (A and B)	Contr Price
KV-100	1" x 1/2"	\$39.20
KV-101	1" x 1"	\$40.20
KV-150	1-1/2" x 3/4"	\$41.70
KV-175	1" x 3/4"	\$39.70
KV-200	2" x 1"	\$44.20
KV-5050	1/2" x 1/2"	\$37.20
KV-75	3/4" x 3/8"	\$37.20
KV-7575	3/4" x 3/4"	\$38.20

Angled Groove

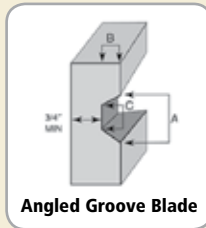

Angled Groove Tool, Blades and Sled Kits

Part Code	Dimensions (A, B and C)	Contr Price
KA-102	1" x 1/2" x 1/2"	\$39.20
KA-104	1" x 3/4" x 1/4"	\$39.20
KA-152	1-1/2" x 1/2" x 1"	\$40.70
KA-154	1-1/2" x 3/4" x 3/4"	\$40.70
KA-201	2" x 1" x 1"	\$43.70
KA-202	2" x 1/2" x 1-1/2"	\$43.70
KA-204	2" x 3/4" x 1-1/4"	\$43.70
KA-301	3" x 1" x 2"	\$50.70



Beveled Groove

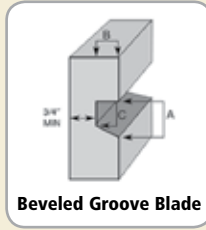

Beveled Groove Tool, Blades and Sled Kits

Part Code	Dimensions (A, B and C)	Contr Price
KB-102	1" x 1/2" x 3/4"	\$49.70
KB-104	1" x 3/4" x 1/2"	\$49.70
KB-151	1-1/2" x 1" x 7/8"	\$51.70
KB-154	1-1/2" x 3/4" x 1"	\$51.70
KB-201	2" x 1" x 1-3/8"	\$53.20
KB-204	2" x 3/4" x 1-1/2"	\$53.20



Square Groove

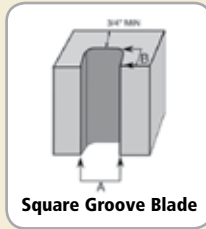

Square Groove Tool, Blades and Sled Kits

Part Code	Dimensions (A and B)	Contr Price
KS-101	1" x 1"	\$49.70
KS-102	1" x 1/2"	\$48.70
KS-103	1" x 3/4"	\$48.70
KS-151	1-1/2" x 1"	\$51.70
KS-152	1-1/2" x 1/2"	\$51.70
KS-153	1-1/2" x 3/4"	\$51.70
KS-201	2" x 1"	\$53.20
KS-203	2" x 3/4"	\$53.20
KS-502	1/2" x 1/2"	\$43.70
KS-752	3/4" x 1/2"	\$45.20
KS-753	3/4" x 3/4"	\$46.20



Buy the Kit and Save!

REPLACEMENT BLADES, SLEDS AND HANDLES



Groove Tool Handle

Part Code	Description	Contr Price	Approx Wt
GT-HANDLE	SS Wood	\$14.70	1 lb
GT-HANDLECS	SS Comfort-Soft	\$15.70	1 lb

Custom Blades Available
See order form at www.wind-lock.com



V Groove Hot Knife Blades ONLY

Part Code	Dimensions (A and B)	Contr Price
HV-100	1" x 1/2"	\$15.50
HV-101	1" x 1"	\$16.50
HV-150	1-1/2" x 3/4"	\$17.00
HV-175	1" x 3/4"	\$16.50
HV-200	2" x 1"	\$18.00
HV-5050	1/2" x 1/2"	\$14.50
HV-75	3/4" x 3/8"	\$14.50
HV-7575	3/4" x 3/4"	\$15.50



V Groove Nylon Sleds

Part Code	Dimensions (A and B)	Contr Price
GSV-100	1" x 1/2"	\$12.00
GSV-101	1" x 1"	\$13.00
GSV-150	1-1/2" x 3/4"	\$14.00
GSV-175	1" x 3/4"	\$12.50
GSV-200	2" x 1"	\$16.00
GSV-5050	1/2" x 1/2"	\$11.00
GSV-75	3/4" x 3/8"	\$11.00
GSV-7575	3/4" x 3/4"	\$11.50



Angled Groove Hot Knife Blades ONLY

Part Code	Dimensions (A, B and C)	Contr Price
HA-102	1" x 1/2" x 1/2"	\$15.50
HA-104	1" x 3/4" x 1/4"	\$17.00
HA-152	1-1/2" x 1/2" x 1"	\$17.00
HA-154	1-1/2" x 3/4" x 3/4"	\$18.00
HA-201	2" x 1" x 1"	\$18.00
HA-202	2" x 1/2" x 1-1/2"	\$18.00
HA-204	2" x 3/4" x 1-1/4"	\$18.00
HA-301	3" x 1" x 2"	\$22.50



Angled Groove Nylon Sleds

Part Code	Dimensions (A, B and C)	Contr Price
GSA-102	1" x 1/2" x 1/2"	\$12.00
GSA-104	1" x 3/4" x 1/4"	\$12.00
GSA-152	1-1/2" x 1/2" x 1"	\$13.00
GSA-154	1-1/2" x 3/4" x 3/4"	\$13.00
GSA-201	2" x 1" x 1"	\$14.00
GSA-202	2" x 1/2" x 1-1/2"	\$14.00
GSA-204	2" x 3/4" x 1-1/4"	\$14.00
GSA-301	3" x 1" x 2"	\$17.00



Beveled Groove Hot Knife Blades ONLY

Part Code	Dimensions (A, B and C)	Contr Price
HB-102	1" x 1/2" x 3/4"	\$15.50
HB-104	1" x 3/4" x 1/2"	\$15.50
HB-151	1-1/2" x 1" x 7/8"	\$17.00
HB-154	1-1/2" x 3/4" x 1"	\$17.00
HB-201	2" x 1" x 1-3/8"	\$18.00
HB-204	2" x 3/4" x 1-1/2"	\$18.00



Beveled Groove Nylon Sled Set

Part Code	Dimensions (A, B and C)	Contr Price
GSB-102	1" x 1/2" x 3/4"	\$25.00
GSB-104	1" x 3/4" x 1/2"	\$25.00
GSB-151	1-1/2" x 1" x 7/8"	\$26.00
GSB-154	1-1/2" x 3/4" x 1"	\$26.00
GSB-201	2" x 1" x 1-3/8"	\$27.00
GSB-204	2" x 3/4" x 1-1/2"	\$27.00

Includes 2 Nylon Sleds, base and finish coats.



Square Groove Hot Knife Blades ONLY

Part Code	Dimensions (A and B)	Contr Price
HS-101	1" x 1"	\$16.00
HS-102	1" x 1/2"	\$16.00
HS-103	1" x 3/4"	\$16.00
HS-151	1-1/2" x 1"	\$17.00
HS-152	1-1/2" x 1/2"	\$17.00
HS-153	1-1/2" x 3/4"	\$17.00
HS-201	2" x 1"	\$18.00
HS-203	2" x 3/4"	\$18.00
HS-502	1/2" x 1/2"	\$14.00
HS-752	3/4" x 1/2"	\$14.50
HS-753	3/4" x 3/4"	\$14.50



Square Groove Nylon Sled Set

Part Code	Dimensions (A and B)	Contr Price
GSS-101	1" x 1"	\$25.00
GSS-102	1" x 1/2"	\$24.00
GSS-103	1" x 3/4"	\$24.00
GSS-151	1-1/2" x 1"	\$26.00
GSS-152	1-1/2" x 1/2"	\$25.00
GSS-153	1-1/2" x 3/4"	\$26.00
GSS-201	2" x 1"	\$24.00
GSS-203	2" x 3/4"	\$27.00
GSS-502	1/2" x 1/2"	\$20.00
GSS-752	3/4" x 1/2"	\$22.00
GSS-753	3/4" x 3/4"	\$23.00

Includes 2 Nylon Sleds, base and finish coats.



FOAM2FOAM® GUN FOAMS

EIFS Contractors' Preferred Gap Filler.



Cleans up hands and tools. See page 32.



Buy the Kit and Save!

A multi-purpose, professional, low-expansion construction adhesive and gap and crack filler. Great for ICF, SIP, EIFS and stone veneer applications. One component polyurethane foam. Cures by absorbing water vapor from the air.

- Used for filling, slivering, sealing and insulating joints and cracks
- Professional quality
- Accurately controlled application
- Moisture-curing
- Acoustical sealant
- Drywall adhesive: reduces fasteners by 60%
- Excellent adhesion to most surfaces
- Temperature, water and chemical resistant
- No CFC/HCFC
- Stone veneer adhesive
- Compatible with EPS foam boards
- Paintable and can be plastered over

Consult your system manufacturer for specific recommendations.

1. W-F2F® Foam and Cleaner

Part Code	Description	Contr Price	Approx Wt
W-F2F24	Wind-lock Foam2Foam Case	CALL	22 lb
W-PGCS	F2F® Gun Cleaner 12 oz Case	CALL	13 lb

2. F2F® Sliver Kit NEW!

KIT INCLUDES: 3 Cans F2F®, 1 Can F2F® Cleaner, 1 W-EG13T Foam Gun, 1 Pair Protective Rubber Coated Gloves.

Part Code	Description	Contr Price	Approx Wt
W-ESK	Wind-lock F2F Kit	CALL	6 lb

3. Contractor's Choice Value Kit NEW!

KIT INCLUDES: 11 Cans of F2F®, 1 Can of F2F® Cleaner, 1 W-EG13T Foam Gun, 1 Pair Protective Rubber Coated Gloves.

Part Code	Description	Contr Price	Approx Wt
W-CCV11	Contractors' Choice Foam Kit	CALL	22 lb

4. 11/1 Foam Convenience Kit

KIT INCLUDES: 1 Can of F2F® Cleaner, 11 Cans of F2F®

Part Code	Description	Contr Price	Approx Wt
W-CLF2F	11/1 Foam Convenience Kit	CALL	22 lb



Stock to Dock Shipping Guarantee

Products highlighted in yellow are guaranteed to ship within 24 hours or freight costs are **FREE!** Larger orders may require additional lead times. Call for details.



FOAM GUNS

All of our guns are engineered to deliver foam day after day with minimal cleaning. The all-metal needle valve construction delivers the polyurethane foam with controlled accuracy. We offer a wide variety, ranging from “do it yourself” models to professional.

ECONOMY SERIES

1. W-EG13T Taper Tip Foam Dispenser

Light-medium duty gun, featuring all-metal needle valve construction and brass tapered tip with universal can adapter and tip. This is our best gun for filling in EPS board gaps.

Part Code	Description	Contr Price	Approx Wt
W-EG13T	Taper Tip Foam Dispenser	\$35.95	2 lb

2. W-EG13

Light-medium duty gun, featuring all-metal needle valve construction and brass universal can adapter and tip.

Part Code	Description	Contr Price	Approx Wt
W-EG13	Economy Foam Dispenser	\$39.95	2 lb

INTERMEDIATE SERIES

3. W-EG14

Medium duty gun featuring a Teflon® coated needle valve and universal can adapter. The knurled brass dispensing tip is the knurled brass that holds the extension tubes in place. Also available with a 31" long extended barrel for long reach or sub floor applications.

Part Code	Description	Contr Price	Approx Wt
W-EG14	Foam Dispenser with Teflon Tip	\$56.50	2 lb
NS W-EG14L	31" Long-Barrel	\$139.75	4 lb
NS W-EG14BT	Brass tips for W-EG14	\$3.75	1 lb

NS=Not shown.

PROFESSIONAL SERIES

4. W-EG15

This professional gun features a narrow tapered tip for dispensing the foam between EIFS board lines. The two stage tapered barrel blends the foam to a superior consistency.

Part Code	Description	Contr Price	Approx Wt
W-EG15	Pageris Foam Dispenser	\$82.35	2 lb

PROPER ATTACHMENT OF FOAM GUNS



1. Attach the gun to the can of F2F®.

4. Removing the can from gun, point can upright and away from your face.



2. The can should point up and away from your face.

5. Clean the gun adapter with the F2F® Cleaner.



3. Shake can for 1 minute and purge air from gun.

6. Attach and spray the cleaner through the gun.

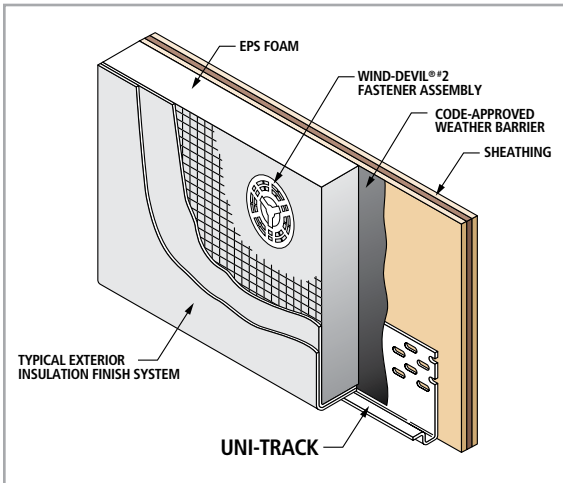

WATER MANAGEMENT

EXCLUSIVE PRODUCT

1. Universal Starter Track

Uni-Track Universal Starter Track is engineered to allow incidental moisture to escape.

- One size fits all
- Reduce inventory
- Eliminates wavy edges
- High impact and rust-proof
- Weep holes 5" on center
- 40 pieces per box

Part Code	Qty/Box	Description	Contr Price/Pc	Approx Wt/Box
W-UST	40	8' Universal Starter Track	\$9.50	44 lb
W-UST10	40	10' Universal Starter Track	\$11.50	65 lb

Now available in 10' sections.

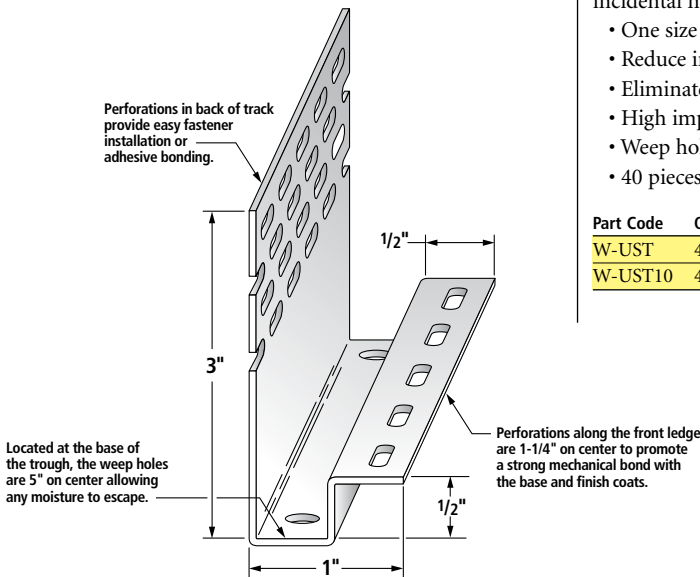

Stock to Dock Shipping Guarantee
 Products highlighted in yellow are guaranteed to ship within 24 hours or freight costs are **FREE!** Larger orders may require additional lead times. Call for details.

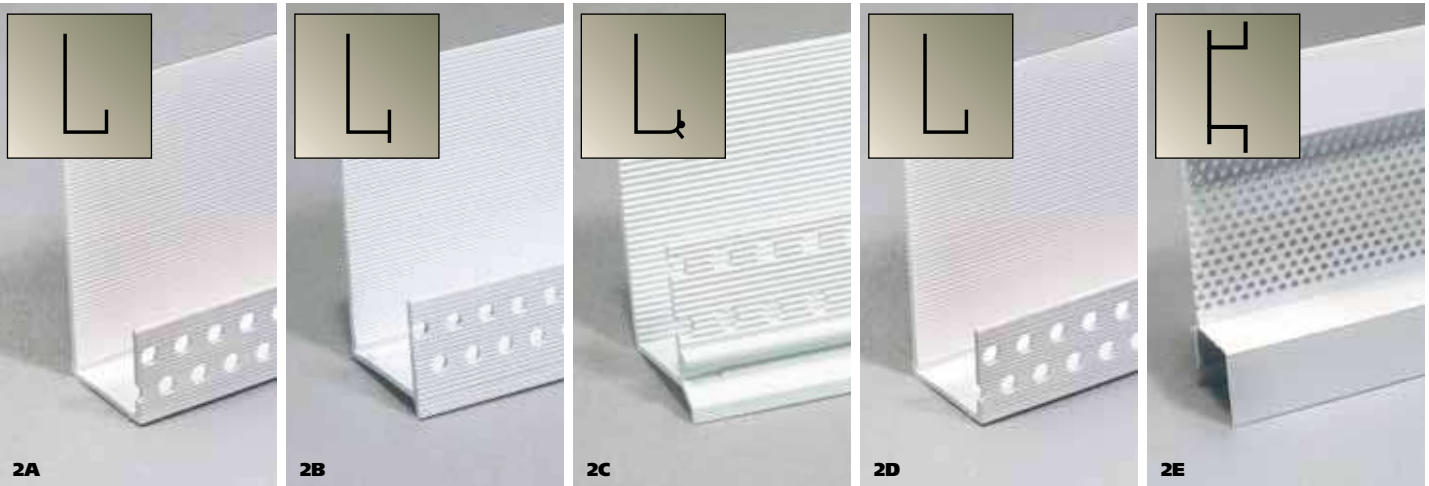

PLASTIC PC
COMPONENTS *inc.*

2. Insulation Starter Tracs

Plastic Components Starter Tracs are designed for use with today's building systems. These Starter Tracs are available by the piece or in full box quantities, and can be shipped UPS/FedEx direct to the job site.

8' Sections

Part Code	Qty/Box	Size	Description	Approx Wt/Box
A WST-1	25	1" x 8'	Casing Bead	53 lb
A WST-15	20	1-1/2" x 8'	Casing Bead	47 lb
A WST-2	15	2" x 8'	Casing Bead	39 lb
A WST-25	15	2-1/2" x 8'	Casing Bead	20 lb
A WST-3	10	3" x 8'	Casing Bead	20 lb
B WSTDE-1	25	1" x 8'	Drip Edge Weep Holes	48 lb
B WSTDE-15	20	1-1/2" x 8'	Drip Edge Weep Holes	43 lb
B WSTDE-2	15	2" x 8'	Drip Edge Weep Holes	36 lb
B WSTDE-25	15	2-1/2" x 8'	Drip Edge Weep Holes	20 lb
B WSTDE-3	10	3" x 8'	Drip Edge Weep Holes	20 lb
B WSTDE-75	30	3/4" x 8'	Drip Edge Weep Holes	47 lb
C WDST-1	25	1" x 8'	Window/Door	43 lb
C WDST-15	20	1-1/2" x 8'	Window/Door	37 lb
C WDST-2	15	2" x 8'	Window/Door	31 lb
D WST8-1WP	25	1" x 8'	Casing Bead Weep Holes	52 lb
D WST8-15WP	20	1-1/2" x 8'	Casing Bead Weep Holes	49 lb
D WST8-2WP	15	2" x 8'	Casing Bead Weep Holes	35 lb
D WST8-75WP	30	3/4" x 8'	Casing Bead Weep Holes	48 lb
E WSV548-1	10	1" x 8'	Continuous Soffit Vent	20 lb
E WSV548-15	8	1-1/2" x 8'	Continuous Soffit Vent	20 lb

Call for pricing.

10' Sections

Part Code	Qty/Box	Size	Description	Approx Wt/Box
A WST10-1	25	1" x 10'	Casing Bead	67 lb
A WST10-15	20	1-1/2" x 10'	Casing Bead	59 lb
A WST10-2	15	2" x 10'	Casing Bead	49 lb
A WST10-25	15	2-1/2" x 10'	Casing Bead	51 lb
A WST10-4	10	4" x 10'	Casing Bead	51 lb
B WSTDE10-1	25	1" x 10'	Drip Edge Weep Holes	60 lb
B WSTDE10-15	20	1-1/2" x 10'	Drip Edge Weep Holes	51 lb
B WSTDE10-2	15	2" x 10'	Drip Edge Weep Holes	48 lb
B WSTDE10-3	10	3" x 10'	Drip Edge Weep Holes	20 lb
B WSTDE10-4	10	4" x 10'	Drip Edge Weep Holes	24 lb
D WSTDE10-75	30	3/4" x 10'	Drip Edge Weep Holes	46 lb
D WSTWP-50	35	1/2" x 10'	Casing Bead Weep Holes	68 lb
D WST-75WP	30	3/4" x 10'	Casing Bead Weep Holes	44 lb
D WST-78WP	30	7/8" x 10'	Casing Bead Weep Holes	45 lb
D WST-1WP	25	1" x 10'	Casing Bead Weep Holes	53 lb
D WST-15WP	20	1-1/2" x 10'	Casing Bead Weep Holes	48 lb
D WST-2WP	15	2" x 10'	Casing Bead Weep Holes	46 lb
D WST10-25WP	15	2-1/2" x 10'	Casing Bead Weep Holes	46 lb
D WST10-3WP	10	3" x 10'	Casing Bead Weep Holes	20 lb
D WST10-4WP	10	4" x 10'	Casing Bead Weep Holes	21 lb

Call for pricing.

For additional stucco and plaster trims, see page 51.



SEE PAGE 13 FOR HAMMER TACKERS AND STAPLES



NEW!

Stock to Dock Shipping Guarantee
 Products highlighted in yellow are guaranteed to ship within 24 hours or freight costs are FREE! Larger orders may require additional lead times. Call for details.

SECONDARY MOISTURE BARRIER WRAP

3. Weather Trek EVD House Wrap

Weather Trek EVD house wrap is the perfect house wrap for EIFS and stucco construction.

Part Code	Qty/Skid	Size	Contr Price/Pc	Approx Wt/Box
W-WTK	36	5' x 200'	CALL	144 lb

4. Tyvek® StuccoWrap™ and Sheathing Tape

Tyvek® StuccoWrap™ from DuPont® is designed and engineered for comfort, energy efficiency and protection from water and moisture damage.

Part Code	Qty/Box	Size	Description	Contr Price/Pc	Approx Wt/Box
W-TST	36	2" x 55 yd	Sheathing Tape	CALL	18 lb
W-TSW5	9	5' x 200'	StuccoWrap	CALL	144 lb

5. Dow® Weathermate™ Housewrap—Plus

Weathermate™ Housewrap—Plus is a non-woven, non-perforated, polyolefin-based housewrap that offers exceptional tear resistance and durability. It is an effective option for builders who prefer to use non-insulating sheathing along with housewrap. When installed over sheathing, Weathermate™ Housewrap—Plus reduces costly air and moisture infiltration. It is translucent to allow a clear view of the studs and the sheathing surface during installation.

Part Code	Qty/Skid	Size	Description	Contr Price	Approx Wt
W-DWM3165	22	3' x 165'	Housewrap Plus	CALL	14 lbs
W-DWM5100	38	5' x 100'	Housewrap Plus	CALL	14 lbs
W-DWM9100	38	9' x 100'	Housewrap Plus	CALL	24 lbs
W-DWM9150	33	9' x 150'	Housewrap Plus	CALL	34 lbs

All other DOW® Weathermate™—Plus sizes are available. Please call.
 Note: Also see Weatherization Section, page 78.

6. Benjamin Obdyke Home Slicker® NEW!

Home Slicker® Stone & Stucco is the only vertically channeled rainscreen that has been specifically designed for use with manufactured stone, natural stone, stucco and masonry applications. Each roll contains the patented Home Slicker® three-dimensional matrix bonded to a fabric which prevents mortar from entering the wall cavity during cladding installation. This product installs with the fabric facing outward.

Home Slicker® Plus Typar® is a cost-effective, labor and material saving, moisture eliminating rainscreen combined with a water resistive barrier. Each roll contains the patented Home Slicker® three-dimensional matrix bonded to Typar®, the premium residential and commercial grade housewrap. The unique, vertically-channeled, three-dimensional matrix of the original Home Slicker® provides a continuous space for drainage and drying, a thermal break and pressure equalization—eliminating the threat of trapped moisture. Home Slicker® 10 is designed to meet the 10mm code requirements in Canada.

Part Code	Qty/Skid	Size	Description	Contr Price	Approx Wt
NS W-HSST	16	39"x61.5' 200 sq ft	Stone & Stucco Rainscreen 6 mil	\$137.45	16 lbs
NS W-HS10ST	16	39"x38.5' 125 sq ft	Stone & Stucco Rainscreen 10 mil	\$113.25	25 lbs
W-HSPT	16	39"x61.5' 200 sq ft	Plus Typar Rainscreen 6 mil	\$137.45	15 lbs
NS W-HS10PT	16	39"x38.5' 125 sq ft	Plus Typar Rainscreen 10 mil	\$113.25	15 lbs
NS W-HS	16	39"x46.5' 150 sq ft	Rainscreen 6 mil	\$88.05	10 lbs
NS W-HS10N	16	39"x38.5' 125 sq ft	Rainscreen 10 mil	\$86.30	8 lbs

NS=Not shown.

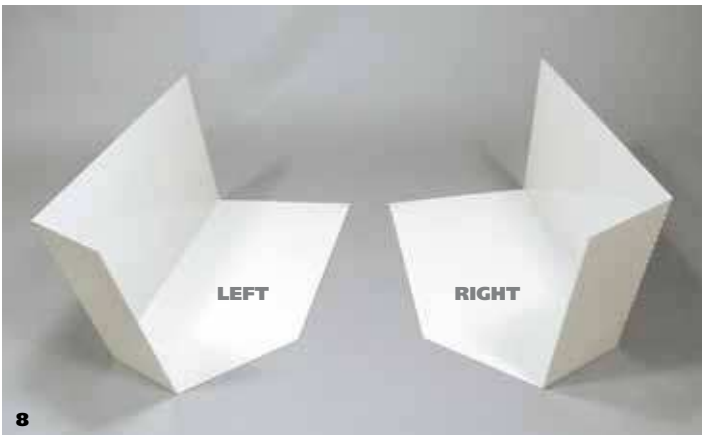
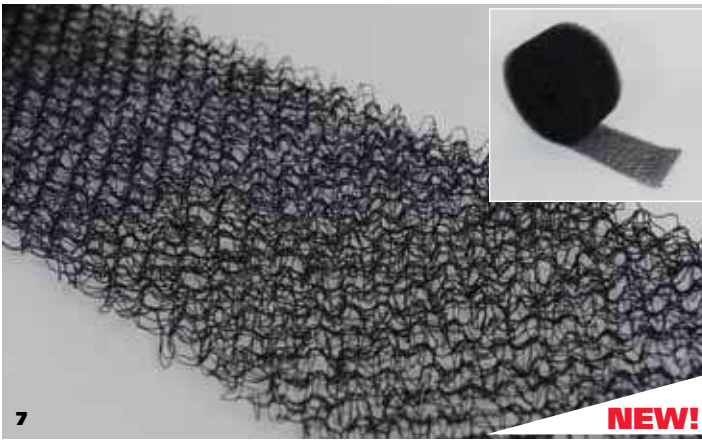

7. Benjamin Obdyke Blockade™ NEW!

Designed specifically for use in brick wall cavities, the entangled matrix design of the Blockade™ Mortar Deflection System blocks mortar from clogging the weep holes and allows excess moisture to flow freely out of the wall cavity. The result is a brick wall that is built to stand the test of time and remains free from the deteriorating effects of mold and mildew.

Part Code	Qty/Skid	Size	Description	Contr Price	Approx Wt
W-BA80	16	50'x 10"x .80"	80 Mortar Deflection .80" thick	\$33.50	5 lb
W-BA150	16	50'x 10"x 1.5"	80 Mortar Deflection 1.5" thick	\$56.35	4 lb

8. Aluminum Kickout Flashing

Part Code	Size	Description	Contr Price	Approx Wt
W-KODL	10" x 6"	Kickout Diverter LH Alum	\$15.30	1 lb
W-KODR	10" x 6"	Kickout Diverter RH Alum	\$15.30	1 lb

Aluminum Kickout Flashing

Powder Coated.

Part Code	Size	Description	Contr Price	Approx Wt
W-KODLB	10" x 6"	Beige Kickout Diverter LH Alum	\$18.95	1 lb
W-KODRB	10" x 6"	Beige Kickout Diverter RH Alum	\$18.95	1 lb
W-KODLG	10" x 6"	Gray Kickout Diverter LH Alum	\$18.95	1 lb
W-KODRG	10" x 6"	Gray Kickout Diverter RH Alum	\$18.95	1 lb
W-KODLW	10" x 6"	White Kickout Diverter LH Alum	\$18.95	1 lb
W-KODRW	10" x 6"	White Kickout Diverter RH Alum	\$18.95	1 lb

9. DryFlekt® Polypropylene Kickout Flashing

The best practice solution for diverting roofline water. The patented design creates a downward and outward water flow off the roof and away from walls, preventing water intrusion at roof-to-wall intersections. DryFlekt® is manufactured in left and right parts, available in six aesthetically pleasing colors: brown, bronze, sand, tan, gray and white.

Part Code	Size	Description	Contr Price	Approx Wt
A W-PKOLB	14" x 6"	Brown Kickout Diverter LH Polypro	\$10.95	1 lb
A W-PKORB	14" x 6"	Brown Kickout Diverter RH Polypro	\$10.95	1 lb
B W-PKORBZ	14" x 6"	Bronze Kickout Diverter RH Polypro	\$10.95	1 lb
B W-PKOLBZ	14" x 6"	Bronze Kickout Diverter LH Polypro	\$10.95	1 lb
C W-PKORS	14" x 6"	Sand Kickout Diverter RH Polypro	\$10.95	1 lb
C W-PKOLS	14" x 6"	Sand Kickout Diverter LH Polypro	\$10.95	1 lb
D W-PKOLT	14" x 6"	Tan Kickout Diverter LH Polypro	\$10.95	1 lb
D W-PKORT	14" x 6"	Tan Kickout Diverter RH Polypro	\$10.95	1 lb
E W-PKOLG	14" x 6"	Gray Kickout Diverter LH Polypro	\$10.95	1 lb
E W-PKORG	14" x 6"	Gray Kickout Diverter RH Polypro	\$10.95	1 lb
F W-PKOLW	14" x 6"	White Kickout Diverter LH Polypro	\$10.95	1 lb
F W-PKORW	14" x 6"	White Kickout Diverter RH Polypro	\$10.95	1 lb



10

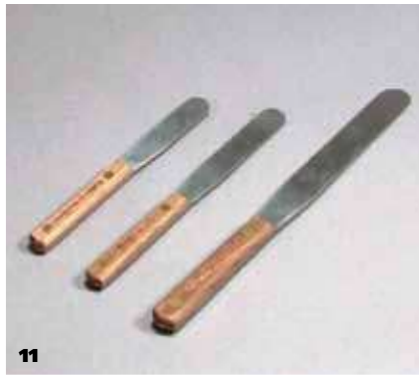

11



13



12A



12B



12



14



15

10. Window/Door Membrane Flashing

A secondary weather barrier for use around windows, doors or any structural opening. Primer is recommended.

Part Code	Qty/Box	Size	Description	Contr Price/Pc	Approx Wt/Box
W-PWDT4	12	4" x 100' x 30 mil	Flashing Tape	\$32.50	99 lb
W-PWDT6	8	6" x 100' x 30 mil	Flashing Tape	\$50.65	96 lb
W-PWDT9	4	9" x 100' x 30 mil	Flashing Tape	\$77.95	80 lb
W-PWDT12	4	12" x 100' x 30 mil	Flashing Tape	\$100.95	98 lb

11. Caulking Spatulas

Part Code	Size	Description	Contr Price	Approx Wt/Box
W-DS3	3" x 5/8"	Spatula	\$13.25	1 lb
W-DS4	4" x 5/8"	Spatula	\$14.35	1 lb
W-DS6	6" x 1"	Spatula	\$15.50	1 lb
W-DSKIT	All Sizes	Detail Spatula Kit	\$41.05	1 lb

12. Backer Rod

Part Code	Size	Description	Contr Price/Pc	Approx Wt/Box
A W-SR38	3/8" x 1800'	Sof-Rod™	\$116.30	5 lb
A W-SR58	5/8" x 1550'	Sof-Rod™	\$133.45	12 lb
A W-SR78	7/8" x 850'	Sof-Rod™	\$126.15	12 lb
A W-SR112	1-1/2" x 552'	Sof-Rod™	\$227.25	23 lb
A W-SR38H	3/8" x 1400'	Sof-Rod™ Handi Pack	\$106.20	5 lb
A W-SR58H	5/8" x 550'	Sof-Rod™ Handi Pack	\$56.45	5 lb
A W-SR78H	7/8" x 330'	Sof-Rod™ Handi Pack	\$62.35	5 lb
B W-SR48	1/2" x 2500'	Hard Rod	\$160.95	11 lb
B W-SR48H	1/2" x 800'	Hard Rod Handi Pack	\$67.95	4 lb
B W-HR34H	3/4" x 400'	Hard Rod Handi Pack	\$69.75	4 lb
B W-HR38H	3/8" x 1400'	Hard Rod Handi Pack	\$89.90	4 lb
B W-HR58H	5/8" x 550'	Hard Rod Handi Pack	\$68.85	4 lb

13. Water Based Primer

Recommended to be used with flashings, wraps and liners. To obtain manufacturer's recommended coverage per gallon, call 1-800-872-5625.

Part Code	Qty/Box	Size	Description	Contr Price	Approx Wt/Box
W-STP	4	1 gallon	Mfg Water Based Primer Trans Wrap	\$63.75	9 lb

14. Dow® Contractors Weatherproofing Sealant

Part Code	Qty/Box	Description	Contr Price/Box	Approx Wt/Box
W-DRAW	(12) 10 oz Tubes	Dow CWS/Antique White	\$69.95	14 lb
W-DRBK	(12) 10 oz Tubes	Dow CWS/Black	\$69.95	14 lb
W-DRBZ	(12) 10 oz Tubes	Dow CWS/Bronze	\$69.95	14 lb
W-DRGR	(12) 10 oz Tubes	Dow CWS/Gray	\$69.95	14 lb
W-DRLS	(12) 10 oz Tubes	Dow CWS/Limestone	\$69.95	14 lb
W-DRSS	(12) 10 oz Tubes	Dow CWS/Sandstone	\$69.95	14 lb
W-DRTW	(12) 10 oz Tubes	Dow CWS/True White	\$69.95	14 lb

Pecora Sealant also available. Call for details.

Consult physical sample before choosing. To obtain a full coverage chart, free color samples and/or custom color details, call 1-800-872-5625.

15. Dow® Corning 790 Silicone Building Sealant

Part Code	Qty/Box	Description	Contr Price/Box	Approx Wt/Box
W-DCAT	(12) 10 oz Tubes	Dow 790 Adobe Tan	\$100.50	14 lb
W-DCBK	(12) 10 oz Tubes	Dow 790 Black	\$100.50	14 lb
W-DCGR	(12) 10 oz Tubes	Dow 790 Gray	\$100.50	14 lb
W-DCNS	(12) 10 oz Tubes	Dow 790 Natural Stone	\$100.50	14 lb
W-DCPC	(12) 10 oz Tubes	Dow 790 Precast White	\$100.50	14 lb

Consult physical sample before choosing. To obtain a full coverage chart, free color samples and/or custom color details, call 1-800-872-5625.

For all Weatherization and Flashing Items, go to page 83.



RASPS AND ACCESSORIES

1. UGZ® II EverRasp

Engineered better. EPS doesn't stand a chance!

- Copper electro-plated tungsten grit
- Uniform even grit
- Permanent: lasts up to 100 times longer than paper
- Rounded corners for gouge free rasping

Part Code	Size	Description	Contr Price	Approx Wt
I-IIUGZ2	2" x 14"	SS Rasp 12-14 Grit	\$44.75	2 lb
I-IIUGZ4	4" x 14"	SS Rasp 12-14 Grit	\$64.75	2 lb
I-IIUGZ6	6" x 14"	SS Rasp 12-14 Grit	\$74.75	3 lb
I-IIUGZ8	8" x 14"	SS Rasp 12-14 Grit	\$84.75	3 lb
I-IIUGZK26	2" and 6" x 14"	SS Rasp Kit	\$119.75	5 lb
I-IITUGZ46	4" and 6" x 14"	Toothed SS Rasp	\$144.75	5 lb

2. UGZ® II TOOTH EverRasp

Engineered better. EPS doesn't stand a chance! Same great UGZ®, but now with a toothed edge for shaving and trimming EPS.

Part Code	Size	Description	Contr Price	Approx Wt
I-IITUGZ4	4" x 14"	Toothed SS Rasp 12-14 Grit	\$68.75	2 lb
I-IITUGZ6	6" x 14"	Toothed SS Rasp 12-14 Grit	\$78.75	3 lb
I-IITUGZ8	8" x 14"	Toothed SS Rasp 12-14 Grit	\$88.75	3 lb
I-IITUGZ46	4" and 6" x 14"	Toothed SS Rasp	\$144.75	5 lb

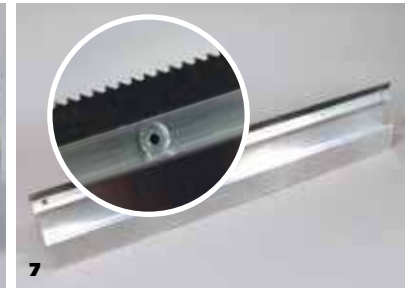

3. Plastic Hand Rasps

Part Code	Size	Description	Contr Price	Approx Wt
I-PSR4	4" x 14"	Plastic Sanding Rasp	\$18.80	1 lb
I-PSR6	6" x 14"	Plastic Sanding Rasp	\$23.05	1 lb

4. Aluminum Hand Rasps

Part Code	Size	Description	Contr Price	Approx Wt
I-SR2	2" x 14"	Sanding Rasp	\$14.50	1 lb
I-SR4	4" x 14"	Sanding Rasp	\$21.70	2 lb
I-SR6	6" x 14"	Sanding Rasp	\$26.95	2 lb
I-SR8	8" x 16"	Sanding Rasp	\$44.25	3 lb

5. Pneumatic Hand Rasp

Part Code	Size	Description	Contr Price	Approx Wt
I-PAR	8" x 18"	Pneumatic Rasp	\$466.85	8 lb

6. Adhesive Rasp Paper Rolls

Part Code	Size	Description	Contr Price	Approx Wt
I-AROLL2	2" x 25 yd	Roll 16 Grit	CALL	6 lb
I-AROLL4	4" x 25 yd	Roll 16 Grit	CALL	11 lb
I-AROLL6	6" x 25 yd	Roll 16 Grit	CALL	15 lb
I-AROLL8	8" x 25 yd	Roll 16 Grit	CALL	20 lb
12-AROLL2	2" x 25 yd	Roll 12 Grit	CALL	5 lb
12-AROLL4	4" x 25 yd	Roll 12 Grit	CALL	10 lb
12-AROLL6	6" x 25 yd	Roll 12 Grit	CALL	18 lb
12-AROLL8	8" x 25 yd	Roll 12 Grit	CALL	19 lb

Non-Adhesive Rasp Paper Rolls

Part Code	Size	Description	Contr Price	Approx Wt
I-ROLL2	2" x 50 yd	Roll 16 Grit	CALL	7 lb
I-ROLL4	4" x 50 yd	Roll 16 Grit	CALL	21 lb
I-ROLL6	6" x 50 yd	Roll 16 Grit	CALL	28 lb
I-ROLL8	8" x 50 yd	Roll 16 Grit	CALL	30 lb
12-IROLL2	2" x 50 yd	Roll 12 Grit	CALL	12 lb
12-IROLL4	4" x 50 yd	Roll 12 Grit	CALL	23 lb
12-IROLL6	6" x 50 yd	Roll 12 Grit	CALL	34 lb
12-IROLL8	8" x 50 yd	Roll 12 Grit	CALL	40 lb

7. Knockdown Rasp

Serrated edge to level large walls in seconds.

Part Code	Size	Description	Contr Price	Approx Wt
HDS-2	2'	Speed Rasp Aluminum	\$69.95	2 lb
HDS-4	4'	Speed Rasp Aluminum	\$117.95	3 lb
HDS-6	6'	Speed Rasp Aluminum	\$167.95	4 lb

8. Adhesive Paper Sheets 12 Pack

Part Code	Size	Description	Contr Price	Approx Wt
I-RPA2	2" x 14"	16 Grit Sheets	CALL	1 lb
I-RPA4	4" x 14"	16 Grit Sheets	CALL	2 lb
I-RPA6	6" x 14"	16 Grit Sheets	CALL	3 lb
I-RPA86	8" x 16"	16 Grit Sheets	CALL	4 lb
I-RPA88	8" x 18"	16 Grit Sheets	CALL	5 lb
12-IRPA2	2" x 14"	12 Grit Sheets	CALL	1 lb
12-IRPA4	4" x 14"	12 Grit Sheets	CALL	2 lb
12-IRPA6	6" x 14"	12 Grit Sheets	CALL	3 lb
12-IRPA86	8" x 16"	12 Grit Sheets	CALL	4 lb
12-IRPA88	8" x 18"	12 Grit Sheets	CALL	5 lb



9



9



11



10



10



12

9. DuraRasp™

Steel tungsten carbide rasp. Heavy brazed #12 tungsten grit.

Part Code	Size	Description	Contr Price	Approx Wt
T-DR2	2" x 14"	DuraRasp Steel	\$45.00	2 lb
T-DR4	4" x 14"	DuraRasp Steel	\$65.00	2 lb
T-DR6	6" x 14"	DuraRasp Steel	\$75.00	3 lb
T-DR8	8" x 14"	DuraRasp Steel	\$85.00	3 lb
T-DRK26	2" and 6" x 14"	DuraRasp Steel Kit	\$120.00	3 lb
T-DRK46	4" and 6" x 14"	DuraRasp Steel Kit	\$140.00	4 lb

10. Tiger Claw DuraRasp™

- Shaves high spots
- Cut-off saw
- #12 tungsten grit

Part Code	Size	Description	Contr Price	Approx Wt
T-TC4	4" x 14"	Tiger Claw	\$69.00	2 lb
T-TC6	6" x 14"	Tiger Claw	\$79.00	2 lb
T-TC8	8" x 14"	Tiger Claw	\$89.00	3 lb
T-TCK46	4" and 6" x 14"	Tiger Claw Kit	\$145.10	4 lb

Buy the Kit and Save!

11. Bull Nose DuraRasp™

Curved tungsten carbide rasp. Heavy, brazed #12 tungsten grit.

- 5" wide bull nose design
- Soft-grip handle

Part Code	Size	Description	Contr Price	Approx Wt
T-DB514	5" x 14"	Bull Nose DuraRasp	\$80.00	2 lb

12. Double Sided DuraRasp™

2-sided tungsten carbide rasp. Heavy, brazed #12 tungsten grit.

- Easy rasping in hard to reach areas
- Built-in knuckle pad
- Soft-grip handle

Part Code	Size	Description	Contr Price	Approx Wt
T-DE614	6" x 14"	Double Sided DuraRasp	\$90.00	2 lb

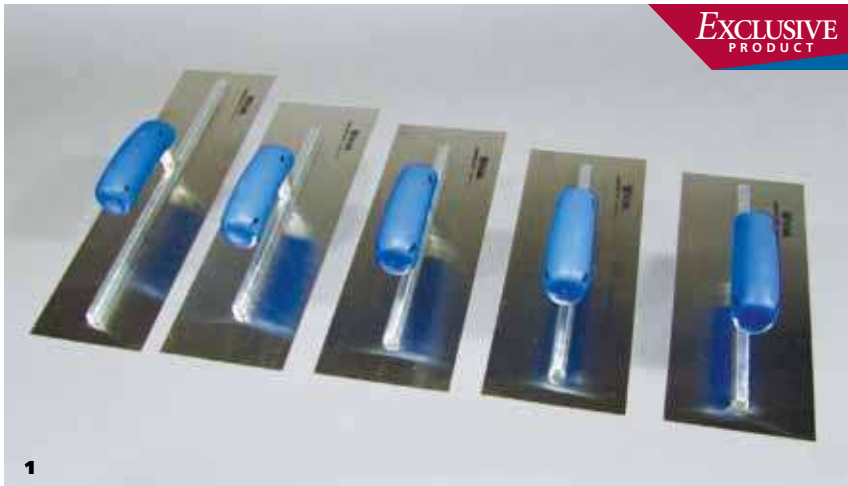

1



2



3



4

WIND-LOCK® COMFORT-SOFT™ HANDLE TROWELS



Finest Hand Crafted Trowels Available.



Stock to Dock Shipping Guarantee

Products highlighted in yellow are guaranteed to ship within 24 hours or freight costs are **FREE!** Larger orders may require additional lead times. Call for details.

A combination of hard plastic core and soft plastic cover for optimum grip between hand and handles. Reduces handgrip tension and relieves strain in the palm, muscles and tendons.

1. Stainless Steel Plastering Trowels

Part Code	Size	Description	Contr Price	Approx Wt
T-115CS	11-1/2" x 4-3/4"	SS Comfort-Soft	\$30.50	2 lb
T-12CS	12" x 4-3/4"	SS Comfort-Soft	\$31.35	2 lb
T-13CS	13" x 4-3/4"	SS Comfort-Soft	\$32.75	2 lb
T-14CS	14" x 4-3/4"	SS Comfort-Soft	\$35.45	2 lb
T-16CS	16" x 4-3/4"	SS Comfort-Soft	\$39.25	2 lb

2. Stainless Steel Venetian Trowels

Round, polished edge for precise craftsmanship.

Part Code	Size	Description	Contr Price	Approx Wt
T-VT2008	7-3/4" x 3-1/8"	SS Comfort-Soft	\$33.95	2 lb
T-VT24011	9-1/2" x 4-1/4"	SS Comfort-Soft	\$36.70	2 lb
T-VT28012	11" x 4-3/4"	SS Comfort-Soft	\$39.45	2 lb

3. Pavan® Trowels

Authentic Italian Pavan® trowels are preferred by artisans worldwide who strive to achieve a superior Venetian finish. Made of INOX stainless steel, Pavan trowels are ideal for preserving the true color of these fine finishes without burning. Its faired lip, ground blade and curved corners ensure perfect application when polishing Venetian stucco.

Part Code	Size	Description	Contr Price	Approx Wt
T-P240CS	9.45" x 3.94" (240 x 80mm)	Pavan SS Trapezoid Finishing Trowel	\$49.95	1 lb
T-P200CS	7.88" x 3.15" (200 x 80mm)	Pavan SS Trapezoid Finishing Trowel	\$46.50	1 lb

4. Stainless Steel Brilliant Venetian Trowels

The smoothest and brightest finish, with a lightweight plastic handle.

Part Code	Size	Description	Contr Price	Approx Wt
T-VPF2008	7-7/8" x 3-1/8"	SS Comfort-Soft	\$27.15	2 lb
T-VPF2411	9-1/2" x 4-3/8"	SS Comfort-Soft	\$27.95	2 lb
T-VPF2812	11" x 4-3/4"	SS Comfort-Soft	\$29.45	2 lb



5



6



7



8



9



10

5. Stainless Steel Margin Trowels

Part Code	Size	Description	Contr Price	Approx Wt
T-M358CS	1-1/2" x 3-5/8"	SS Comfort-Soft	\$10.25	1 lb
T-M55CS	2" x 5-1/2"	SS Comfort-Soft	\$10.25	1 lb
T-M7CS	1-1/2" x 7"	SS Comfort-Soft	\$10.25	1 lb
T-SSMKITCS	All Sizes	SS Comfort-Soft Kit	\$27.45	2 lb

6. Carbon Steel Margin Trowels

Part Code	Size	Description	Contr Price	Approx Wt
T-M515CS	1-1/2" x 5"	CRS Comfort-Soft	\$12.55	1 lb
T-M52CS	2" x 5"	CRS Comfort-Soft	\$13.55	1 lb
T-M62CS	2" x 6"	CRS Comfort-Soft	\$14.55	1 lb
T-M82CS	2" x 8"	CRS Comfort-Soft	\$17.55	1 lb
T-SMKITCS	All Sizes	CRS Comfort-Soft Kit	\$50.55	2 lb

7. Outside Corner Edgers

Stainless steel.

Part Code	Size	Description	Contr Price	Approx Wt
T-E75CS	3/4"	SS Comfort-Soft	\$11.85	1 lb
T-E1CS	1"	SS Comfort-Soft	\$11.85	1 lb
T-E15CS	1-1/2"	SS Comfort-Soft	\$11.85	1 lb
T-E2CS	2"	SS Comfort-Soft	\$11.85	1 lb
T-EKITCS	All Sizes	SS Comfort-Soft Kit	\$42.45	2 lb

8. Inside Corner Edgers

Stainless steel.

Part Code	Size	Description	Contr Price	Approx Wt
T-EI75CS	3/4"	SS Comfort-Soft	\$11.85	1 lb
T-EI1CS	1"	SS Comfort-Soft	\$11.85	1 lb
T-EI15CS	1-1/2"	SS Comfort-Soft	\$11.85	1 lb
T-EI2CS	2"	SS Comfort-Soft	\$11.85	1 lb
T-EIKITCS	All Sizes	SS Comfort-Soft Kit	\$42.45	2 lb

9. Pointed and Round Detail Trowels

Stainless steel.

Part Code	Size	Description	Contr Price	Approx Wt
T-RDTCS	6-1/2" x 2-3/8"	SS Round Detail Comfort-Soft	\$9.85	1 lb
T-PDTCS	5-1/2" x 3-1/4"	SS Pointed Detail Comfort-Soft	\$9.85	1 lb
T-DTKITCS	All Sizes	SS Comfort-Soft Kit	\$17.75	2 lb

10. Pipe Trowel

Carbon steel.

Part Code	Size	Description	Contr Price	Approx Wt
T-PTCS	11-1/2" x 3-1/2"	CRS Comfort-Soft	\$25.15	1 lb

**Buy the Kit
and Save!**



11



12



13



14



Stock to Dock Shipping Guarantee

Products highlighted in yellow are guaranteed to ship within 24 hours or freight costs are **FREE!** Larger orders may require additional lead times. Call for details.

11. Comfort-Soft™ Applicator Tool Bag Kit NEW!

KIT INCLUDES: canvas tool bag, 13" x 13" Hawk, rubber coated knit gloves, Bucket Dredger, T-PFTAN float, 4" x 14" stainless steel rasp, Boss® Biggie Wipes, 3" scraper knife, margin trowels: 2" x 5-1/2", outside corner edgers: 1" and 2", inside corner edgers: 1" and 2", 11-1/2" x 4-3/4" stainless steel finish trowel.

Part Code	Description	Contr Price	Approx Wt
W-TBK2CS	Tool Bag Kit Comfort-Soft Handles	\$250.95	15 lb
NS W-TBK2	Tool Bag Kit Wood Handles	\$245.95	15 lb

NS=Not shown.

Also see Ultimate EIFS Kit on page 14.



12. Bucket Opener

Part Code	Description	Contr Price	Approx Wt
B-BO2	3 in 1 Aluminum	\$21.50	1 lb

13. Red Stucco Tape — BEST SELLER!

Weather-resistant stucco tape. The red tape is designed to cover all metal, plastic and vinyl surfaces. Larger widths available upon request. Not for use on glass.

Part Code	Qty/Box	Size	Contr Price/Pc	Approx Wt/Box
W-SRT2	24	2" x 60 yd	\$8.95	27 lb
W-SRT4	12	4" x 60 yd	\$18.55	28 lb

14. Boss® Biggies Industrial Wipes

These dual-sided industrial wipes clean paint, adhesives, oil and more from hands, tools and surfaces.

Part Code	Description	Size	Contr Price
W-BW	Dual-sided abrasive wipes 80 wipes per container	8" x 12"	\$25.95



WIND-LOCK® EZ-GRIP HANDLE TROWELS

Experience all the benefits of regular Comfort-Soft™ Handle Trowels but in a smaller grip with greater finger protection. Made with a combination of hard plastic core and soft plastic cover, the EZ-Grip Trowel reduces hand grip tension and relieves strain in the palm, muscles and tendons.

15. EZ-Grip Pointed Margin Trowel

Carbon steel.

Part Code	Size	Description	Contr Price	Approx Wt
T-MPRCS	1-3/16" x 5"	CS Pointed Margin Trowel	\$12.55	2 lb

16. EZ-Grip Bucket Trowels

Stainless steel.

Part Code	Description	Contr Price	Approx Wt
T-BTSRCS	SS Bucket Trowel	\$16.85	1 lb
T-SBTRCS	SS Small Bucket Trowel	\$15.50	1 lb

17. EZ-Grip Plastering Trowel

Stainless steel.

Part Code	Size	Description	Contr Price	Approx Wt
T-13RCS	5-1/8" x 11"	SS Finishing Trowel	\$32.75	2 lb

18. EZ-Grip Outside Corner Edges Trowels

Stainless steel.

Part Code	Size	Description	Contr Price	Approx Wt
T-E75RCS	3/4"	SS Edger	\$11.85	1 lb
T-E1RCS	1"	SS Edger	\$11.85	1 lb
T-E15RCS	1-1/2"	SS Edger	\$11.85	1 lb
T-E2RCS	2"	SS Edger	\$11.85	1 lb

19. EZ-Grip Inside Corner Edges Trowels

Stainless steel.

Part Code	Size	Description	Contr Price	Approx Wt
T-EI75RCS	3/4"	SS Edger	\$11.85	1 lb
T-EI1RCS	1"	SS Edger	\$11.85	1 lb
T-EI15RCS	1-1/2"	SS Edger	\$11.85	1 lb
T-EI2RCS	2"	SS Edger	\$11.85	1 lb



EZ-Grip Handle Trowels

- Smaller Handle
- Reduces Hand Tension
- Fingertip Protection

Shown with removable hanging display tag.



WIND-LOCK® WOOD HANDLE TROWELS

1. Right and Left Handed 90° Corner Edgers

Stainless steel.

Part Code	Size	Description	Contr Price	Approx Wt
T-90L75	3/4" x 3/4"	Left Wood	\$11.75	1 lb
T-90L1	1" x 1"	Left Wood	\$11.75	1 lb
T-90L15	1-1/2" x 1-1/2"	Left Wood	\$11.75	1 lb
T-90L2	2" x 2"	Left Wood	\$11.75	1 lb
T-90LKIT	All Sizes	—	\$42.65	2 lb
T-90R75	3/4" x 3/4"	Right Wood	\$11.75	1 lb
T-90R1	1" x 1"	Right Wood	\$11.75	1 lb
T-90R15	1-1/2" x 1-1/2"	Right Wood	\$11.75	1 lb
T-90R2	2" x 2"	Right Wood	\$11.75	1 lb
T-90RKIT	All Sizes	—	\$42.65	2 lb

2. Right and Left Handed 45° Corner Edgers

Stainless steel.

Part Code	Size	Description	Contr Price	Approx Wt
T-45L1	1-1/4" x 1-1/4"	Left Wood	\$11.75	1 lb
T-45L15	2" x 2"	Left Wood	\$11.75	1 lb
T-45L2	2-3/4" x 2-3/4"	Left Wood	\$11.75	1 lb
T-45LKIT	All Sizes	—	\$31.95	2 lb
T-45R1	1-1/4" x 1-1/4"	Right Wood	\$11.75	1 lb
T-45R15	2" x 2"	Right Wood	\$11.75	1 lb
T-45R2	2-3/4" x 2-3/4"	Right Wood	\$11.75	1 lb
T-45RKIT	All Sizes	—	\$31.95	2 lb

3. Outside Corner Edgers

Stainless steel.

Part Code	Size	Description	Contr Price	Approx Wt
T-E75	3/4" x 3/4"	Outside Wood	\$10.75	1 lb
T-E1	1" x 1"	Outside Wood	\$10.75	1 lb
T-E15	1-1/2" x 1-1/2"	Outside Wood	\$10.75	1 lb
T-E2	2" x 2"	Outside Wood	\$10.75	1 lb
T-EKIT	All Sizes	—	\$37.75	2 lb

4. Inside Corner Edgers

Stainless steel.

Part Code	Size	Description	Contr Price	Approx Wt
T-EI75	3/4" x 3/4"	Inside Wood	\$10.75	1 lb
T-EI1	1" x 1"	Inside Wood	\$10.75	1 lb
T-EI15	1-1/2" x 1-1/2"	Inside Wood	\$10.75	1 lb
T-EI2	2" x 2"	Inside Wood	\$10.75	1 lb
T-EIKIT	All Sizes	Inside Wood	\$37.75	2 lb

5. Inside/Outside Corner Trowels

Stainless steel.

Part Code	Size	Description	Contr Price	Approx Wt
T-CTIS	4" x 4"	Inside Wood	\$16.25	1 lb
T-CTOS	4" x 4"	Outside Wood	\$16.25	1 lb

6. Margin Trowels

Stainless steel.

Part Code	Size	Description	Contr Price	Approx Wt
T-M358	1-1/2" x 3-5/8"	SS Wood	\$8.75	1 lb
T-M55	2" x 5-1/2"	SS Wood	\$8.75	1 lb
T-M7	1-1/2" x 7"	SS Wood	\$8.75	1 lb
T-SSMKIT	All Sizes	—	\$22.95	2 lb

7. Pointed and Round Detail Trowels

Stainless steel.

Part Code	Size	Description	Contr Price	Approx Wt
T-PDT	6-1/2" x 2-3/8"	Pointed Wood	\$8.35	1 lb
T-RDT	5-1/2" x 3-1/4"	Rounded Wood	\$8.35	1 lb
T-DTKIT	All Sizes	Detailing Kit	\$14.95	1 lb



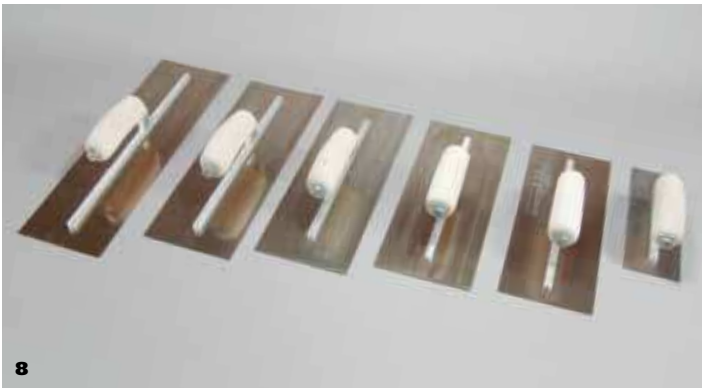

8



9



10



11



12

8. Marshalltown® Camel Back Trowels

Golden stainless steel, wood handle.

Part Code	Size	Description	Contr Price	Approx Wt
T-P115	4-3/4" x 11-1/2"	GSS Wood	\$36.95	1 lb
T-P12	5" x 12"	GSS Wood	\$39.50	2 lb
T-P13	5" x 13"	GSS Wood	\$40.15	2 lb
T-P14	5" x 14"	GSS Wood	\$47.85	2 lb
T-P16	5" x 16"	GSS Wood	\$49.15	2 lb
T-P83	3" x 8"	CRS Wood Midget	\$30.25	1 lb

9. Marshalltown® DuraSoft Trowels

- Golden Stainless Steel
- Soft Handled PermaShape® Blade

Part Code	Size	Description	Contr Price	Approx Wt
T-DS115	4-3/4" x 11-1/2"	GSS DuraSoft	\$45.25	1 lb
T-DS12	5" x 12"	GSS DuraSoft	\$49.75	1 lb
T-DS13	5" x 13"	GSS DuraSoft	\$50.95	2 lb
T-DS14	5" x 14"	GSS DuraSoft	\$51.50	2 lb
T-DS16	5" x 16"	GSS DuraSoft	\$57.75	2 lb

10. Marshalltown® Margin Trowels

Carbon steel, hardwood handle.

Part Code	Size	Description	Contr Price	Approx Wt
T-M515	1-1/2" x 5"	CRS Wood	\$14.75	1 lb
T-M52	2" x 5"	CRS Wood	\$15.75	1 lb
T-M62	2" x 6"	CRS Wood	\$19.75	1 lb
T-M82	2" x 8"	CRS Wood	\$23.75	1 lb
T-SMKIT	All Sizes	CRS Wood	\$69.75	2 lb

11. Kraft® Pool Trowels

Stainless steel, wood handle.

Part Code	Size	Description	Contr Price	Approx Wt
T-KPL10	10" x 3"	SS Wood	\$28.95	1 lb
T-KPL12	12" x 3-1/2"	SS Wood	\$29.90	1 lb
T-KPL14	14" x 4"	SS Wood	\$31.90	1 lb
T-KPL16	16" x 4"	SS Wood	\$33.90	1 lb

12. Curry® Finishing Trowels

Part Code	Size	Description	Contr Price	Approx Wt
T-C101C	5" x 12"	SS Wood	\$32.25	1 lb
T-C102C	5" x 13"	SS Wood	\$34.85	1 lb
T-C103C	5" x 14"	SS Wood	\$34.85	1 lb
T-C4511	4-1/2" x 11"	SS Wood	\$32.25	1 lb
T-C45115	4-1/2" x 11-1/2"	SS Wood	\$32.25	1 lb
T-C47115	4-3/4" x 11-1/2"	SS Wood	\$32.25	1 lb
T-CSS516C	5" x 16"	SS Wood	\$32.25	1 lb

Other sizes available. Call for details.

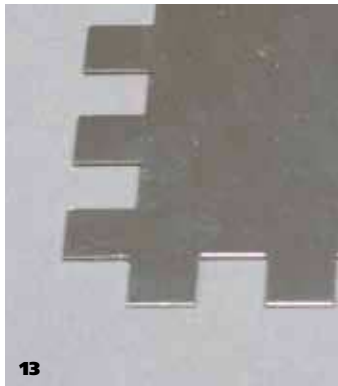

13



14

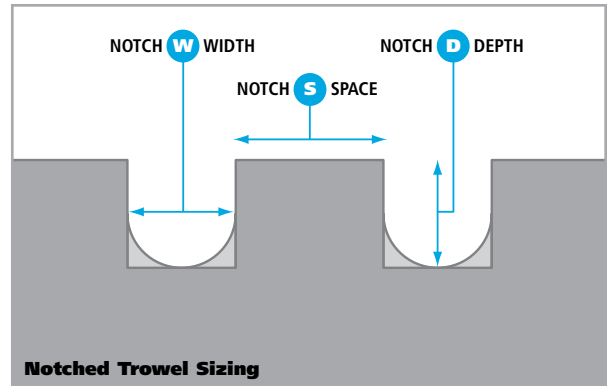

13



14A



14B

EXCLUSIVE PRODUCT

13. Square Notched Trowel

Stainless steel, wood handle, 5" x 12" trowel.

Part Code	Notch Size (W x D x S)	Description	Contr Price	Approx Wt
T-N532	5/32" x 5/32" x 5/32"	SS Wood	\$16.15	1 lb
T-N516	5/16" x 5/16" x 5/16"	SS Wood	\$16.15	1 lb
T-N732	7/32" x 7/32" x 7/32"	SS Wood	\$16.15	1 lb
T-N38	3/8" x 3/8" x 3/8"	SS Wood	\$16.15	1 lb
T-N58	5/8" x 5/8" x 5/8"	SS Wood	\$24.75	1 lb

Custom Notched Trowel

Options include stainless steel or carbon steel, wood or Comfort-Soft™ handle, square or round notches, and left-handed orientation.

Part Code	Size	Description	Contr Price	Approx Wt
CUSTOM-12	5" x 12"	SS Wood	\$31.75	1 lb
CUSTOM-DNC12	5" x 12"	SS Comfort-Soft	\$33.15	1 lb



14. Round Notched Trowel

Stainless steel, wood or Comfort-Soft™ handle, 5" x 12" trowel.

Part Code	Notch Size (W x D x S)	Description	Contr Price	Approx Wt
A T-N1212	1/2" x 1/2" x 1/2"	SS Wood	\$24.75	1 lb
A T-N122P	1/2" x 1/2" x 2"	SS Wood	\$24.75	1 lb
A T-N1415	1/4" x 1/4" x 1-1/2"	SS Wood	\$24.75	1 lb
A T-N31615	3/16" x 1/4" x 1-1/2"	SS Wood	\$24.75	1 lb
A T-N316316	3/16" x 3/16" x 3/16"	SS Wood	\$24.75	1 lb
A T-N31658	3/16" x 3/16" x 5/8"	SS Wood	\$24.75	1 lb
A T-N316D	3/16" x 3/8" x 1 3/4"	SS Wood	\$24.75	1 lb
A T-N381415	3/8" x 1/4" x 1-1/2"	SS Wood	\$24.75	1 lb
A T-N3815	3/8" x 1/2" x 1-1/2"	SS Wood	\$24.75	1 lb
A T-N51675	5/16" x 5/16" x 3/4"	SS Wood	\$24.75	1 lb
A T-N58P	5/8" x 5/8" x 1"	SS Wood	\$24.75	1 lb
B T-DN122P	1/2" x 1/2" x 2"	SS Comfort-Soft	\$24.05	1 lb
B T-DN1415	1/4" x 1/4" x 1-1/2"	SS Comfort-Soft	\$24.05	1 lb
B T-DN31615	3/16" x 1/4" x 1-1/2"	SS Comfort-Soft	\$24.05	1 lb
B T-DN316316	3/16" x 3/16" x 3/16"	SS Comfort-Soft	\$24.05	1 lb
B T-DN31658	3/16" x 3/16" x 5/8"	SS Comfort-Soft	\$24.05	1 lb
B T-DN316D	3/16" x 3/8" x 1-3/4"	SS Comfort-Soft	\$24.05	1 lb
B T-DN381415	3/8" x 1/4" x 1-1/2"	SS Comfort-Soft	\$24.05	1 lb
B T-DN3815	3/8" x 1/2" x 1-1/2"	SS Comfort-Soft	\$24.05	1 lb
B T-DN51675	5/16" x 5/16" x 3/4"	SS Comfort-Soft	\$24.05	1 lb
B T-DN58P	5/8" x 5/8" x 1"	SS Comfort-Soft	\$24.05	1 lb



Left-handed trowel shown.

**Almost
20" Long!**



15



16



17



18

**Perfect
for Venetian
Plaster.**



19

SPECIALTY TROWELS

15. Smoothing Trowel

Stainless steel.

Part Code	Size	Description	Contr Price	Approx Wt
T-STA	5-1/8" x 19-3/4"	HD SS Wood	\$43.50	2 lb

Custom notching available.

16. E-Z Trowel

The E-Z Trowel allows you to coat joints on radius surfaces. It can be used on EIFS, drywall and plaster materials. Made of high density plastic for shape retention and easy cleanup.

Part Code	Size	Description	Contr Price	Approx Wt
T-EZ20	20"	Straight	\$39.00	1 lb
T-EZ26	26"	Straight	\$49.00	1 lb
T-EZC20	20"	Inner Surface Curve	\$39.00	1 lb
T-EZC26	26"	Inner Surface Curve	\$49.00	1 lb
T-EZO20	20"	Outer Surface Curve	\$39.00	1 lb
T-EZO26	26"	Outer Surface Curve	\$49.00	1 lb
T-EZ3K20	20"	Outer, Straight and Inner Kit	\$111.89	3 lb
T-EZ3K26	26"	Outer, Straight and Inner Kit	\$158.15	4 lb

**Buy the Kit
and Save!**

17. Ornamental Tools

Stainless steel trowels designed for detailing of ornate foam shapes and unusual wall surfaces.

Part Code	Size	Description	Contr Price	Approx Wt
T-OT10	10 mm	Each	\$11.95	1 lb
T-OT16	16 mm	Each	\$12.95	1 lb
T-OT20	20 mm	Each	\$13.50	1 lb
T-OT26	26 mm	Each	\$13.95	1 lb
T-OT30	30 mm	Each	\$14.50	1 lb
T-OTKIT	All Sizes	Ornamental Tool Kit	\$56.00	1 lb

18. Japan Scraper Kit

Stainless steel.

For venetian plaster finishes. Rounded edges, 4 sizes: 2", 3", 4" and 4-3/4".

Part Code	Size	Description	Contr Price	Approx Wt
T-JT3290K	2", 3", 4" and 4-3/4"	SS Rounded Trowels	\$15.70	1 lb

19. Comfort-Soft™ Bottle Opener

Part Code	Contr Price	Approx Wt
T-BOOP	\$5.50	1 lb

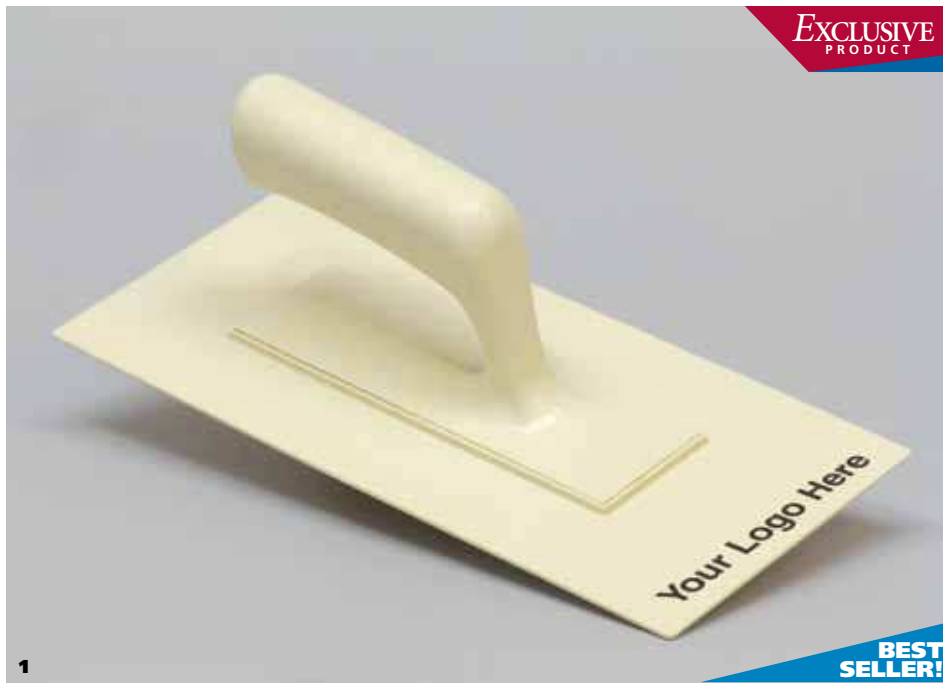

FLOATS

1. T-PFTAN

#7 texture rounded with pre-broken-in edges. This “non-breakable” ABS plastic float is balanced and has a thin return shaft for a comfortable grip. 5" x 11".

Part Code	Size	Description	Contr Price	Approx Wt
T-PFTAN	5" x 11"	Each	\$9.50	1 lb

CUSTOMIZE YOUR FLOAT! Send us clear black and white logo art (camera ready—not a fax) 1" high x 2-3/4" wide for imprint on your T-PFTAN float order. Order minimum is 4 packs or 48 pieces.

Part Code	Size	Description	Contr Price	Approx Wt
T-LPFTAN	5" x 11"	Tan Float w/Logo	\$9.50	1 lb

2. Plastic Texture

An economical alternative to the T-PFW.

Part Code	Size	Contr Price	Approx Wt
T-PPF	5-1/4" x 11" x 3/32"	\$10.50	1 lb

3. Plastic Texture

For texturing almost any aggregate style finish.

Part Code	Size	Contr Price	Approx Wt
T-PFW	5-1/4" x 11-3/4" x 1/8"	\$10.50	1 lb

4. Plastic Texture

For intermediate texture finishes.

Part Code	Size	Contr Price	Approx Wt
T-PFWHITE	5-1/4" x 11-3/4" x 1/8"	\$10.50	1 lb

5. Pavan Plastic Trowel NEW!

A material texturing float with a unique composition blade.

Part Code	Size	Description	Contr Price	Approx Wt
T-PVR280	11" x 5.12" (280 x 130 mm)	Reinforced Plastic Sicodur Base Trowel	\$16.75	1 lb
T-PVR240	9.45" x 3.45" (240 x 100 mm)	Reinforced Plastic Sicodur Base Trowel	\$15.60	1 lb
T-PVRA200	7.87" x 3.15" (200 x 80 mm)	Sicodur Riveted Base Trowel w/Alum. Support	\$12.50	1 lb
T-PVRA280	11" x 5.12" (280 x 130 mm)	Sicodur Riveted Base Trowel w/Alum. Support	\$16.25	1 lb



Stock to Dock Shipping Guarantee

Products highlighted in yellow are guaranteed to ship within 24 hours or freight costs are **FREE!** Larger orders may require additional lead times. Call for details.

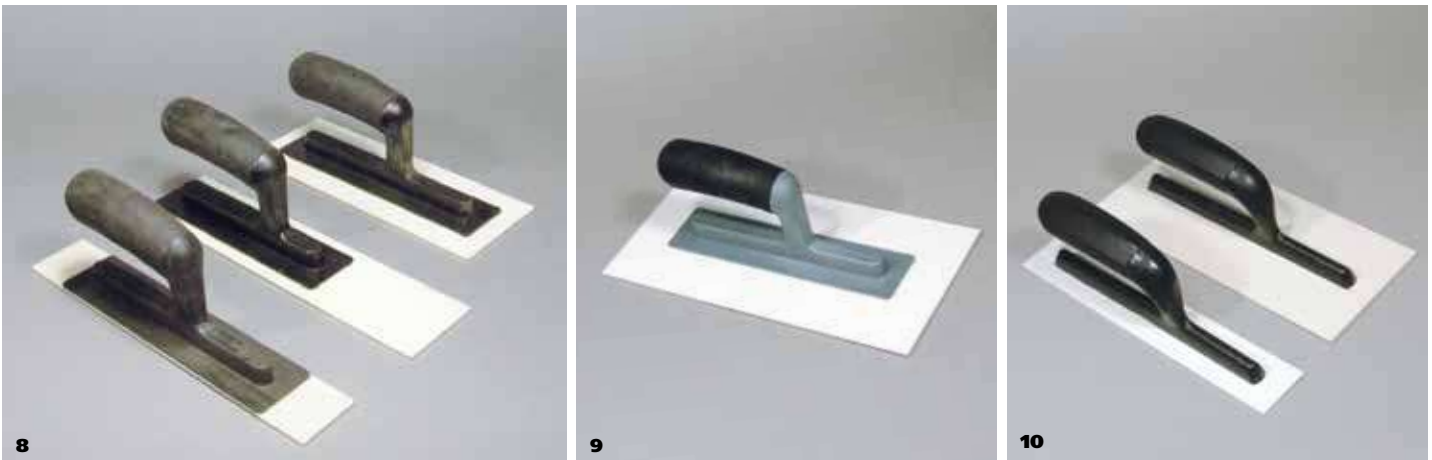
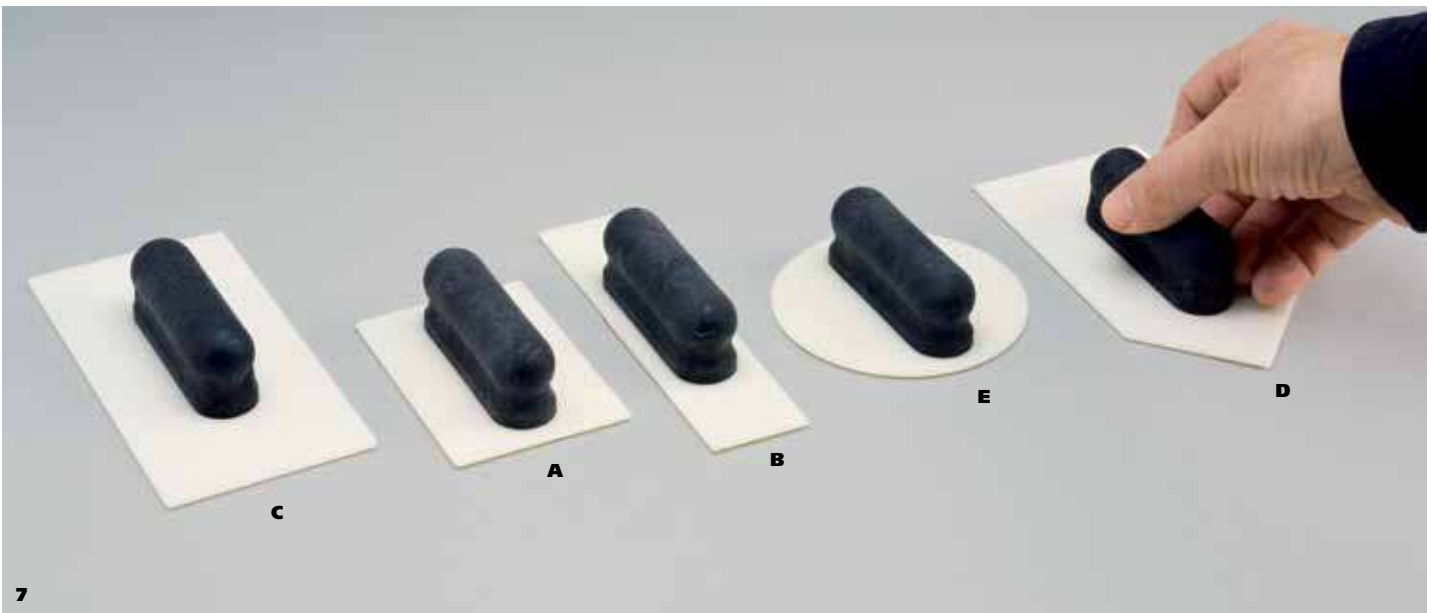

6. NKI Rounded Float **NEW!**

Tapered coned handle. PVC plate with rounded corners. 5" x 11"

Part Code	Size	Description	Contr Price	Approx Wt
W-F400R	5" x 11"	NKI Float with Rounded Edges	\$10.95	1 lb

7. Plastic Small Blade Float

Part Code	Size	Description	Contr Price	Approx Wt	
A	T-PFM107	2-3/4" x 4"	Each	\$4.95	1 lb
B	T-PFM164	1-1/2" x 6-1/4"	Each	\$4.95	1 lb
C	T-PFM168	3-1/8" x 6-1/4"	Each	\$5.15	1 lb
D	T-PFM168SP	3-1/8" x 6-1/4"	Each	\$5.05	1 lb
E	T-PFM100	4"	Each	\$5.05	1 lb
	T-PFMNCK	All 5 Sizes	Mini Plastic Float Kit	\$21.75	1 lb

8. Plastic Medium Blade Float

Part Code	Size	Description	Contr Price	Approx Wt
T-PFM249	3-1/2" x 9-1/2"	Each	\$8.25	1 lb
T-PFM287	2-3/4" x 11"	Each	\$8.25	1 lb
T-PFM285	2" x 11"	Each	\$7.95	1 lb

9. ABS Blade Float

Part Code	Size	Contr Price	Approx Wt
T-PFWHITECS	5-1/4" x 11-3/4"	\$8.99	1 lb

10. Italian Floats

White PVC finishing float.

Part Code	Size	Contr Price	Approx Wt
T-PF286	2" x 11"	\$10.50	1 lb
T-PF2813	5" x 11"	\$11.05	1 lb

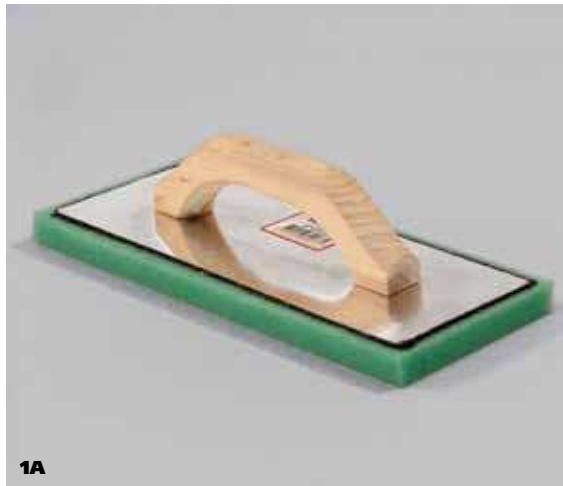

1A

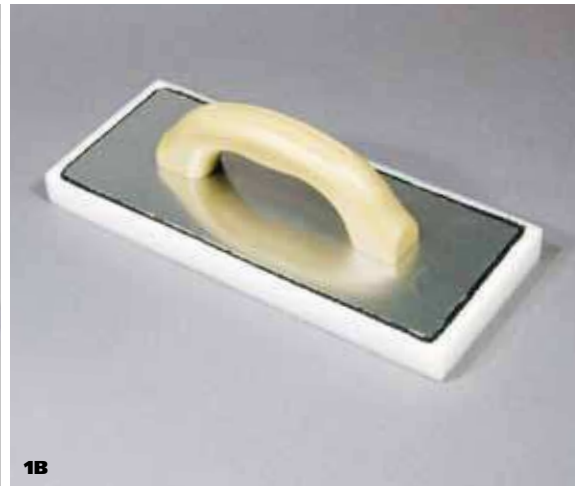

1B



1C

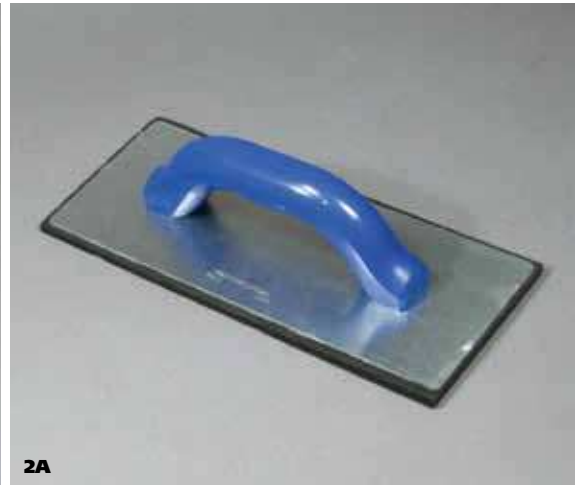

2A

SPONGE FLOATS

1. Sponge Floats

	Part Code	Size	Description	Contr Price	Approx Wt
A	W-GSF	5" x 12" x 1"	Green Hard	\$5.90	1 lb
A	W-GSF34	5" x 12" x 3/4"	Green Hard	\$3.75	1 lb
B	W-WSF	5" x 12" x 1"	White Medium	\$5.90	1 lb
C	T-RF41212	4" x 12" x 1/2"	Red Hard	\$4.30	1 lb

2. Neoprene

For busy textures on heavy aggregate finishes.

	Part Code	Size	Description	Contr Price	Approx Wt
	T-FNEO	5" x 12" x 1/8"	Neoprene Float Hard	\$10.75	1 lb
	T-NF412	4" x 12" x 1/2"	Brown Neoprene Float Hard	\$5.75	1 lb
	T-NF512	5" x 12" x 1/2"	Brown Neoprene Float Hard	\$6.25	1 lb

Great for:

- Stucco
- Plaster
- Cement
- Pools
- Tile/Grout

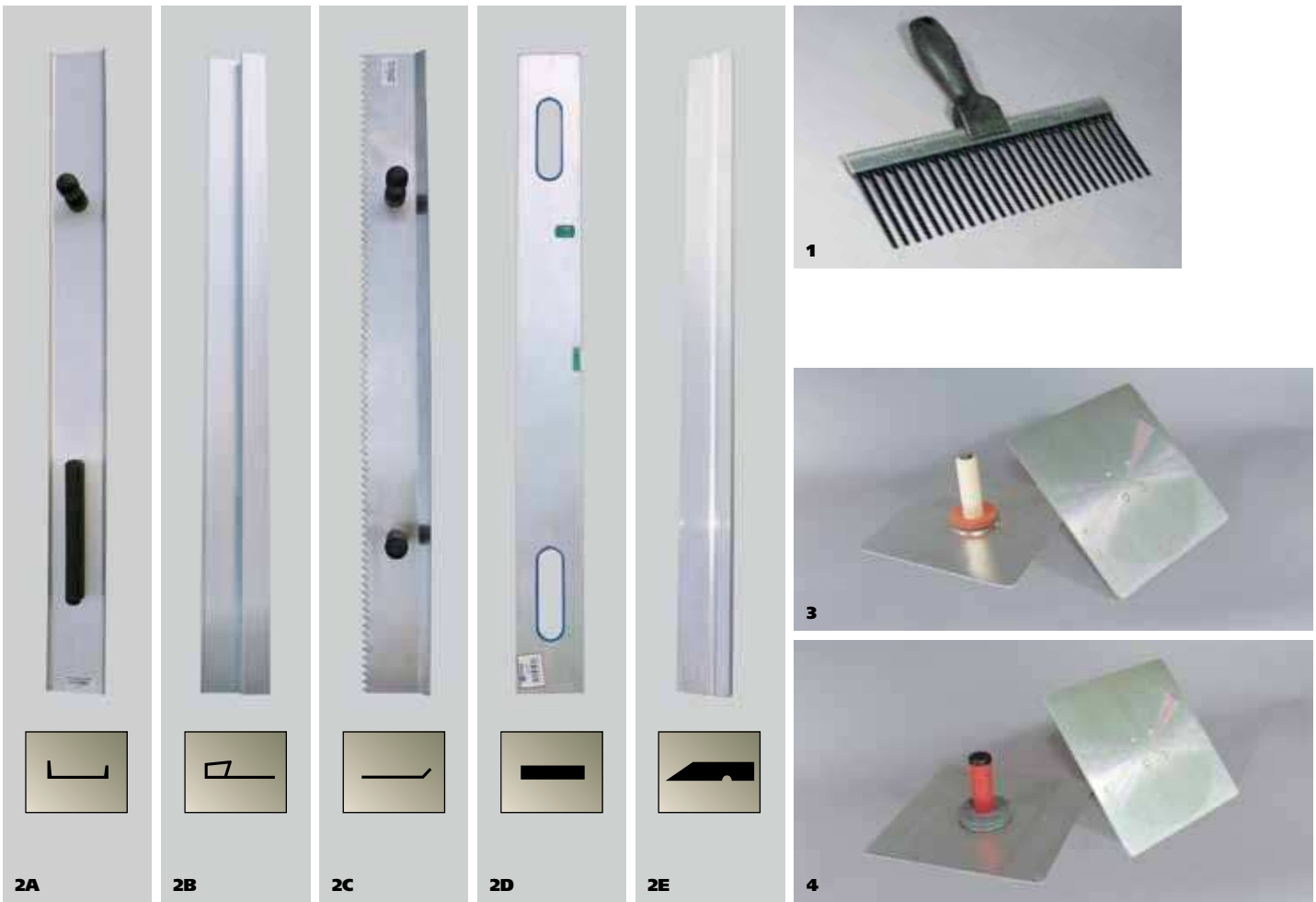

DARBIES/HAWKS

1. 12" Plastic Scarifier

Part Code	Size	Contr Price	Approx Wt
T-PLSC16	12"	\$12.60	1 lb

2. Aluminum Darbies

Lightweight and well-balanced.

Part Code	Size	Description	Contr Price	Approx Wt
A T-DSSM42	42" x 4" x 1/2"	42" Single Serrated Magnesium	\$45.75	2 lb
B HBD-4	48" x 4-3/8" x 1-1/8"	Aluminum Browning H Style	\$25.50	3 lb
B HBD-6	72" x 4-3/8" x 1-1/8"	Aluminum Browning H Style	\$38.25	4 lb
B HBD-8	96" x 4-3/8" x 1-1/8"	Aluminum Browning H Style	\$51.05	5 lb
C T-SCD42	42" x 4-1/2" x 1/2"	Scratcher Darbie	\$21.50	2 lb
D AL-5	59-3/8" x 3-15/16" x 3/4"	Leveling Darbie	\$41.85	2 lb
D AL-6	79" x 3-15/16" x 3/4"	Leveling Darbie	\$52.25	3 lb
D AL-8	98-5/8" x 3-15/16" x 3/4"	Leveling Darbie	\$59.60	4 lb
D AL-10	118-3/8" x 3-15/16" x 3/4"	Leveling Darbie	\$64.30	4 lb
E TBD-4	48" x 3-3/4" x 5/8"	Trapezoid Darbie	\$30.70	3 lb
E TBD-5	60" x 3-3/4" x 5/8"	Trapezoid Darbie	\$38.25	3 lb

3. Kraft® Hawks

Part Code	Size	Description	Contr Price	Approx Wt
T-KH13	13" x 13"	Aluminum Wood Handle	\$21.45	2 lb
T-KH14	14" x 14"	Aluminum Wood Handle	\$22.95	2 lb
T-KHM12	12" x 12"	Magnesium Wood Handle	\$33.90	1 lb
T-KHM13	13" x 13"	Magnesium Wood Handle	\$38.40	2 lb
T-KHM14	14" x 14"	Magnesium Wood Handle	\$43.90	2 lb

4. Marshalltown® Hawks

Part Code	Size	Description	Contr Price	Approx Wt
T-HP10	10" x 10"	Aluminum DuraSoft Handle	\$23.50	1 lb
T-HP12	12" x 12"	Aluminum DuraSoft Handle	\$23.70	2 lb
T-HP13	13" x 13"	Aluminum DuraSoft Handle	\$26.05	2 lb
T-HP135	13-1/2" x 13-1/2"	Aluminum DuraSoft Handle	\$29.40	2 lb
T-H13	13" x 13"	Aluminum Wood Handle	\$24.50	2 lb
T-HM13	13" x 13"	Magnesium DuraSoft Handle	\$45.75	2 lb
T-HM14	14" x 14"	Magnesium DuraSoft Handle	\$50.95	2 lb

NEW & IMPROVED BUCKET DREDGER



Ergonomic grip provides better comfort and superior leverage.

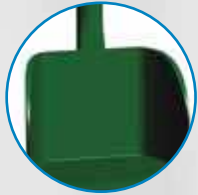

Improved scoop design is easier and lighter to use.

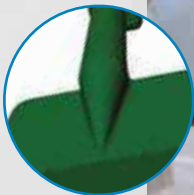

Fewer seams are easier to clean and accumulate less material.



EXCLUSIVE PRODUCT

1



3



4

A

B

C

5

BUCKET ACCESSORIES

1. Bucket Dredger EXCLUSIVE!

NEW improved design for 2010!

- Ergonomic grip
- Easier and lighter to use
- Single piece mold
- Fewer Seams

Part Code	Description	Contr Price	Approx Wt
B-DR	Single	\$13.95	1 lb

2. Mix Fix Bucket Holder

Prevents spinning.

5-gallon bucket holder has 2-foot holders to keep the bucket steady while mixing.

Part Code	Description	Contr Price	Approx Wt
NS T-MF5G	Plastic 5 Gallon Bucket Holder	\$17.95	3 lb

NS=Not shown.

3. Big Dipper

Part Code	Description	Contr Price	Approx Wt
T-BD	CRS Wood	\$17.25	1 lb

4. Bucket Trowel

- Comfort-Soft™ or wood handle
- Stainless steel

Part Code	Description	Contr Price	Approx Wt
T-BTSCS	SS Comfort-Soft	\$16.85	1 lb
T-BTS	SS Wood	\$15.50	1 lb

5. Bucket Openers

Part Code	Description	Contr Price	Approx Wt
A B-BO1	The Hero	\$24.95	1 lb
B B-BO2	3 in 1 Aluminum	\$21.50	1 lb
C B-BO3	Plastic	\$3.50	1 lb



1



3A



3B



3C



2



3D



3E



3F

MIXING AND SPRAYING TOOLS

1. ConTrol™ Nylon Fiber Reinforcement

Fibers for secondary reinforcement to enhance the strength and durability for concrete, mortar and stucco.

Part Code	Qty/Box	Contr Price/Box	Approx Wt/Box
NS I-SCON	1	\$3.35	1 lb
I-CONPOP	36	\$116.00	10 lb
NS I-RCONPOP	150	\$345.65	35 lb

NS=Not shown.

2. 2-Gallon Hopper Gun

Part Code	Contr Price	Approx Wt
W-SHG	\$123.90	7 lb

3. Mixing Blades

Part Code	Size	Description	Contr Price	Approx Wt
A B-M1	23-1/2" x 6-3/8" x 1/2"	Galvanized	\$49.30	3 lb
B B-MEW	32" x 7-1/2" x 1/2"	Inverted	\$66.60	4 lb
C B-MSQ	30" x 8-1/2" x 5"	Square	\$17.95	2 lb
D B-MTW	29" x 8-1/2" x 3/8"	Square Twisted	\$15.80	2 lb
E TR-FBM2	24" x 5" x 3/8"	2 Fixed Wheel	\$12.25	2 lb
F B-MAD	28" x 7-1/2" x 7/16"	Inverted Blade Mixer	\$26.75	3 lb



Stock to Dock Shipping Guarantee

Products highlighted in yellow are guaranteed to ship within 24 hours or freight costs are **FREE!** Larger orders may require additional lead times. Call for details.

TAPES AND FILMS

1. Red Stucco Tape — BEST SELLER!

Weather-resistant stucco tape. The red tape is designed to cover all metal, plastic and vinyl surfaces. Larger widths available upon request. Not for use on glass.

Part Code	Qty/Box	Size	Contr Price/Pc	Approx Wt/Box
W-SRT2	24	2" x 60 yd	\$8.95	27 lb
W-SRT4	12	4" x 60 yd	\$18.55	28 lb

2. Black Stucco Tape

Weather-resistant stucco tape. The black tape is designed to cover all metal, plastic and vinyl surfaces.

Part Code	Qty/Box	Size	Contr Price/Pc	Approx Wt/Box
W-BKT2	24	2" x 60 yd	\$9.25	27 lb
W-BKT4	12	4" x 60 yd	\$17.05	28 lb

3. Filament Tape

Part Code	Qty/Box	Size	Contr Price/Cont	Approx Wt/Box
W-FT1	36	1" x 60 yd	\$4.00	14 lb
W-FT2	24	2" x 60 yd	\$7.35	28 lb

4. Blue Masking Tape

Wind-lock® weather-resistant masking tape is silver to reflect ultraviolet light. The rubber resin adhesive makes it perfect for outdoor holding and protection uses.

Part Code	Qty/Box	Size	Contr Price/Pc	Approx Wt/Box
W-BMT1	36	1" x 60 yd	\$3.75	18 lb
W-BMT15	32	1-1/2" x 60 yd	\$5.75	17 lb
W-BMT2	24	2" x 60 yd	\$7.75	20 lb



5



6



7

5. Window/Door Membrane Flashing

A secondary weather barrier for use around windows, doors or any structural opening. Primer is recommended.

Part Code	Qty/Box	Size	Description	Contr Price/Roll	Approx Wt/Box
W-PWDT4	12	4" x 100' x 30 mil	Flashing Tape	\$32.50	99 lb
W-PWDT6	8	6" x 100' x 30 mil	Flashing Tape	\$50.65	96 lb
W-PWDT9	4	9" x 100' x 30 mil	Flashing Tape	\$77.95	80 lb
W-PWDT12	4	12" x 100' x 30 mil	Flashing Tape	\$100.95	98 lb

6. Bond Breaker Tape

Part Code	Qty/Box	Size	Description	Contr Price/Roll	Approx Wt/Box
W-BBT14	24	1/4" x 108'	Bond Breaker Tape	\$9.50	5 lb
W-BBT38	24	3/8" x 108'	Bond Breaker Tape	\$10.35	5 lb
W-BBT12	18	1/2" x 108'	Bond Breaker Tape	\$13.50	5 lb
W-BBT34	18	3/4" x 108'	Bond Breaker Tape	\$17.50	7 lb
W-BBT1	12	1" x 108'	Bond Breaker Tape	\$18.55	5 lb

7. Window Film Tapes, 200 yards

Larger widths and test rolls are available upon request.

Part Code	Qty/Box	Size	Contr Price/Roll	Approx Wt/Box
W-BFT2	12	2" x 200 yd	\$13.00	27 lb
W-BFT4	6	4" x 200 yd	\$16.00	26 lb
W-BFT6	4	6" x 200 yd	\$19.95	27 lb
W-BFT12	2	12" x 200 yd	\$59.95	27 lb
W-BFT21	1	21" x 200 yd	\$87.00	36 lb
W-BFT24	1	24" x 200 yd	\$89.95	42 lb
W-BFT36	1	36" x 200 yd	\$149.95	52 lb



1



2

FOAM CUTTING EQUIPMENT

1. JobCut

- Cuts 12" at 90°
- Capacity: 2' x 4' x 1'
- Harp moves, not the table
- 110 volts—also available in 220 volts
- Does not include sawhorses or wood
- Folds quickly to only 5" for easy storage
- Cutting Width: 48"
- Cuts from 1° to 90°
- Includes 25' wire

Part Code	Description	Contr Price	Approx Wt
W-JBC	JobCut Hot Wire Machine Only	CALL	70 lb
W-MJBC	JobCut Hot Wire with Magnum	CALL	48 lb

2. Block Buddy

Cornice/ICF Block Cutter.

- Miters from 0° to 45°
- Cuts 18" deep block
- 24" depth cut at 90°
- 16" depth cut at 45°
- Shaves, cuts and miters
- Plastic composite tabletop
- Legs fold for easy storage
- Includes 25' wire

Part Code	Description	Contr Price	Approx Wt
W-MBLKB	Block Buddy with Magnum	CALL	49 lb

Other tables available. Call for details.



3. SideWinder

Ornamental 4' Shape cutter.

- Cuts compound miters, straight cuts, columns and decorative mouldings
- 110 volts—also available in 220 volts
- Uses your hardboard template patterns to trace shapes
- (4) 360° pilot bearings
- Capacity: 2' x 2' x 4'
- Table is 48" x 96"
- Includes 50' wire

Part Code	Description	Contr Price	Approx Wt
W-MSW4	4' SideWinder with Magnum	CALL	210 lb

4. StyroCut 15

- Capacity: 15" deep by 4' wide
- Table tilts and locks 0°–45°
- Portable—weighs only 117 pounds
- Designed to cut vertical and horizontal straight cuts, channels, angles and tapers
- Table is 27" x 60"
- Vertical cut foot pedal
- Includes 50' wire

Part Code	Description	Contr Price	Approx Wt
W-MCSTY	StyroCut with Magnum	CALL	165 lb

5. BowCutters and Accessories

Free form cutters.

Part Code	Description	Contr Price	Approx Wt
I-BC12	12" BowCutter with Power Box	CALL	9 lb
I-BC24	24" BowCutter Only	CALL	12 lb
I-BC48	48" BowCutter Only	CALL	19 lb
I-MBC24	24" BowCutter with Magnum	CALL	19 lb
I-MBC48	48" BowCutter with Magnum	CALL	25 lb

6. Hot Wire Kit

Everything you need to build your own 4' hot wire machine.

KIT INCLUDES: Magnum Controller, Gator Cord, 2 insulators, spring, and 100' roll of Nichrome wire.

Part Code	Description	Contr Price	Approx Wt
W-DHW100	Hot Wire Kit	CALL	13 lb

7. Replacement Accessories

Part Code	Description	Contr Price	Approx Wt
NS W-MAGC	Magnum Controller Only	CALL	12 lb
NS W-DGC	4' Gator Cord	CALL	1 lb
NS I-DHW100	100' 23ga Nichrome 80 wire	CALL	1 lb

NS=Not shown.

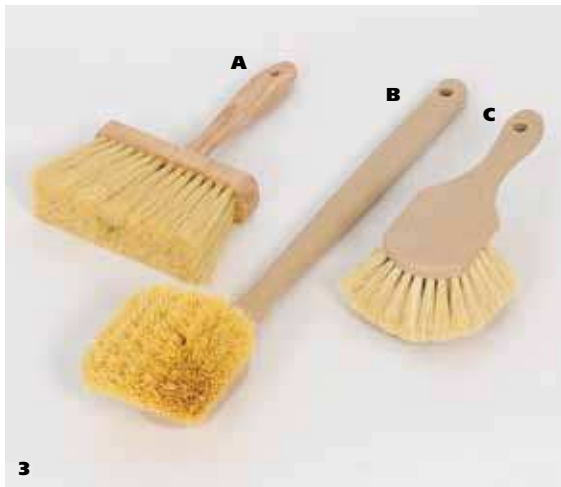

CLEAN-UP

1. Smoothing Brush

Part Code	Size	Contr Price	Approx Wt
B-SM1PK	1"/12 pack	\$29.55	1 lb
B-SM2PK	2"/12 pack	\$41.80	2 lb

2. Blister Brush and Replacement Pad

Part Code	Contr Price	Approx Wt
BB-GB	\$24.95	2 lb
BB-GBR	\$12.35	1 lb

3. Tampico Cleaning Brushes

Part Code	Size	Contr Price	Approx Wt
A B-BB6	6" Bucket Brush	\$9.25	1 lb
B B-BB20	20"	\$7.60	2 lb
C B-GTAB	8-1/2"	\$6.40	1 lb

4. Cellulose Sponge

Part Code	Contr Price	Approx Wt
T-GCS	\$2.90	1 lb

5. Grouting Sponge

Special hydro-philated design has high water-holding capacity.

Part Code	Contr Price	Approx Wt
T-XLGS	\$2.55	1 lb



6

6. Boss® Biggies Industrial Wipes

These dual-sided industrial wipes clean paint, adhesives, oil and more from hands, tools and surfaces.

Part Code	Description	Size	Contr Price
W-BW	Dual-sided abrasive wipes 80 wipes per container	8" x 12"	\$25.95

7. Stretch Wrap

Part Code	Size	Contr Price	Approx Wt
W-SW18	18" x 1500'	\$15.95	36 lb



7



8



9

8. BIG O Tool Cleaner

A citrus cleaner designed for removal of synthetic stucco from tools, equipment and building surfaces. Great for removing adhesives, silicone caulking, decals, ink, asphalt, grease and tar from porous surfaces.

Part Code	Size	Description	Contr Price	Approx Wt/Case
W-AOC	14 oz can	Can of Tool Cleaner	\$11.65	14 lb
W-AOJ	Gallon	Gallon of Tool Cleaner	\$66.35	32 lb

9. Tool Cleaner

Removes synthetic stucco from tools and equipment. Great for cleaning trowel and other often-used hand tools. Helps prolong your tool life.

Part Code	Size	Description	Contr Price	Approx Wt/Case
W-TM	18 oz can	Can of Tool Cleaner	\$10.95	14 lb



1



2



3



4



5

CHEMICALS

1. General Purpose Cleaner

Spray applied to natural masonry, stucco, synthetic stucco and other wall surfaces. Removes dirt, soot and pollution.

Part Code	Size	Contr Price	Approx Wt
MP-2107G	Case of 4 gallons	\$72.99	28 lb

2. Titan Penetrating Sealer

Titan is not a "topical" sealer. Instead, it penetrates the surface voids and "locks-up" surface integrity without forming a vapor barrier. Titan is a reacted silicate sealer with essentially the same chemical makeup as glass (silica), resulting in a non-yellowing, breathable surface.

Part Code	Size	Contr Price	Approx Wt
W-TPS1	Gallon	\$43.00	9 lb
W-TPS5	5 gallons	\$184.00	45 lb

3. Rust Remover & Phosphatizer

This clear, liquid, chemical compound reverses the process that causes rusting and oxidation. It destroys the corrosive agents that support rust and leaves a clean, phosphatized, paintable surface.

Part Code	Size	Contr Price	Approx Wt
MP-G2108	Gallon	\$22.95	7 lb

4. Efflorescence Remover

Sprays into natural masonry, stucco, synthetic stucco and other wall surfaces. Removes efflorescence and other acid-soluble stains. 400 square feet of coverage.

Part Code	Size	Contr Price	Approx Wt
MP-G2112	Case of 4 gallons	\$72.99	28 lb

5. Miracle Mildew Remover

Removes mildew from stucco surfaces and building faces. 500 ft coverage.

Part Code	Size	Contr Price	Approx Wt
W-MMRC	1 bag	\$12.80	1 lb

6. Rubber Coated Gloves

Part Code	Size	Contr Price	Approx Wt
NS W-10CG	10 pack	\$13.50	1 lb

NS=Not shown.

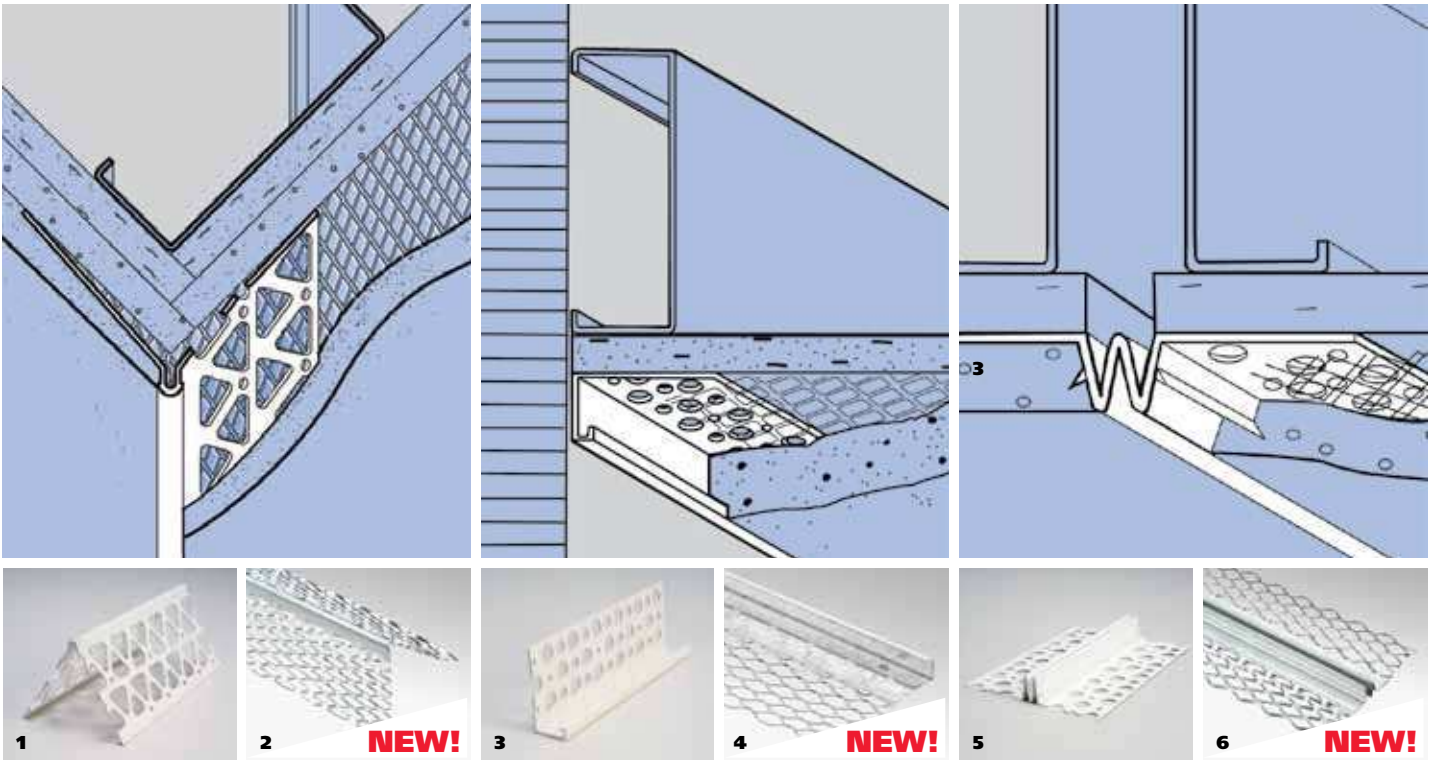

STUCCO AND PLASTER ACCESSORIES

1. Vinyl Corner Beads

Vinyl corners provide hard-to-damage, rust-proof straight corners. They are easily curved to create for smooth arches.

Part Code	Qty/Box	Ground	Description	Contr Price/Pc	Approx Wt/Bx
W-CB8	50	ANY	8' with 2-1/2" perforated flanges	CALL	45 lb

2. Metal Corner Beads **NEW!**

Phillips #1 Expanded Corner Bead provides strong corner reinforcement for conventional plaster applications. Solid nose provides straight, rigid ground and 2-5/8" flanges can be flexed over uneven surfaces. Plaster keys near solid nose help ensure straight corners. Phillips #33 Wide Expanded Flange Bead provides rigidity for masonry, beams, and column fireproofing.

Part Code	Qty/Box	Ground	Description	Contr Price/Pc	Approx Wt/Bx
W-CB01E	40	ANY	8' with #1 Expanded Flange	CALL	TBD
W-CB33W	40	ANY	8' with #33 Wide Flange	CALL	TBD
W-CBEV	60	ANY	8' Expanded Veneer	CALL	TBD

3. Vinyl Casing Beads/Plaster Stops

Vinyl corner beads are used to terminate stucco and plaster against doors, windows and dissimilar materials.

Part Code	Qty/Box	Ground	Description	Contr Price/Pc	Approx Wt/Bx
W-CBPS50	100	1/2"	1-3/4" perforated flange	CALL	80 lb
W-CBPS75	75	3/4"	1-3/4" perforated flange	CALL	60 lb

4. Metal Casing Beads/Plaster Stops **NEW!**

Phillips #66 Expanded Flange Square Casing is a universal plaster stop for wall terminations, openings and intersections, and protects edges from damage and helps cover shrinkage cracks.

Part Code	Qty/Box	Ground	Description	Contr Price/Pc	Approx Wt/Bx
W-CBPSEF1	30	1"	8' with #66 Expanded Flange	CALL	55 lb
W-CBPSEF3	30	3/8"	8' with #66 Expanded Flange	CALL	51 lb
W-CBPSEF5	30	1/2"	8' with #66 Expanded Flange	CALL	51 lb
W-CBPSEF6	30	3/4"	8' with #66 Expanded Flange	CALL	51 lb
W-CBPSEF7	30	5/8"	8' with #66 Expanded Flange	CALL	49 lb
W-CBPSSF3	30	3/8"	8' with #66 Expanded Flange	CALL	51 lb
W-CBPSSF5	30	1/2"	8' with #66 Expanded Flange	CALL	40 lb
W-CBPSSF6	30	5/8"	8' with #66 Expanded Flange	CALL	51 lb
W-CBPSSF7	30	3/4"	8' with #66 Expanded Flange	CALL	44 lb
W-CBPSSF8	30	7/8"	8' with #66 Expanded Flange	CALL	44 lb

5. Vinyl Control Joints

Vinyl joints are designed to relieve stress and assist in controlling cracking in large areas of walls and ceilings. Specially designed connector clips are provided for alignment and base for sealants.

Part Code	Qty/Box	Ground	Description	Contr Price/Pc	Approx Wt/Bx
W-CJ50	35	1/2"	4" perforated flange	CALL	49 lb
W-CJ75	26	3/4"	4" perforated flange	CALL	40 lb

6. Metal Control Joints **NEW!**

Phillips #15 Double V Expansion Joint relieves expansion and contraction stresses during stucco curing. Phillips #15 minimizes plaster cracking and helps ensure proper plaster or stucco thickness.

Part Code	Qty/Box	Ground	Description	Contr Price/Pc	Approx Wt/Bx
W-CJE3	24	3/8"	8' with #15 3/8" Expansion Joint	\$1.79	TBD
W-CJE5	24	1/2"	8' with #15 1/2" Expansion Joint	\$1.84	TBD

For additional stucco and plaster trims, see pages 22 and 23.



1



2



3



4



5



6

STONE VENEER TOOLS

1. Stone Veneer Kit

KIT INCLUDES: canvas tool bag, 14" stone nipper, 4" x 8-3/4" chisel, 11-1/2" x 4-3/4" Comfort-Soft™ plastering trowel, R11 Hammer Tacker, 6-1/2" Mortar hoe, Reload reel, pointed detail trowel, 7/16" x 7" Aesthetic detail, 8-1/2" Tampico Brush, 12" Plastic Scarifier, 3 12" x 23" grout bags.

Part Code	Description/Size	Contr Price	Approx Wt
W-STVK	Stone Veneer Kit	\$278.45	18 lb

2. Stucco Rub Brick

Smooth hardened stucco surfaces.

Part Code	Size	Contr Price	Approx Wt
T-RB6	3" x 6" x 1"	\$13.55	2 lb

3. Stone Nipper

Made from high-grade tool steel, deep tempered.

Part Code	Description/Size	Contr Price	Approx Wt
T-STN	14" Stone Nipper	\$52.50	2 lb

4. Brick Hammer

20 oz., solid steel brick hammer with soft grip handle. Designed for breaking, trimming and cleaning brick.

Part Code	Description/Size	Contr Price	Approx Wt
T-SBH	20 oz. Brick Hammer	\$30.15	2 lb

5. Mason's Chisel

Slip-resistant grooved rubber grip, 5" long handle.

Part Code	Description/Size	Contr Price	Approx Wt
T-CH	4" x 8 3/4"	\$25.75	2 lb

6. Disposable Plastic Grout Bag

Made of heavy duty plastic. Tips can be cut to the desired opening. Disposable, eliminates the need for cleanup.

Part Code	Description/Size	Contr Price	Approx Wt
T-GBD	21" x 11"	\$16.95/Box of 50	4 lb



7



8



9



10



11



12



13

NEW!

7. Poly Grout Bag

Poly molded permanently in bag, 3/8" tip, 12" wide at top.

Part Code	Description/Size	Contr Price	Approx Wt
T-GBP	12" x 23"	\$4.95/Each	1 lb

8. Hammer Tacker Rapid R11

Medium duty, easy to load, easy to operate. All-steel construction. Designed for high-speed tacking over large areas.

Part Code	Description/Size	Contr Price	Approx Wt
T-HTRR11	Medium Duty Tacker	\$47.40	2 lb
T-STHT1/4	1/4" staples, 5,000 per box	\$3.85	1 lb

9. Heavy-Duty Utility Tub

Made from heavy gauge hi-molecular weight polyethylene.

Part Code	Description/Size	Contr Price	Approx Wt
T-CT	23" x 16" x 6" Tub	\$36.75	3 lb

For Additional Rainscreen and Weatherization Products, go to page 85.

10. Short Handled Hoe

6-1/2" blade with a 21" handle.

Part Code	Description/Size	Contr Price	Approx Wt
T-HM65	Short Handled Hoe	\$28.80	1 lb

11. Mortar Hoe

7" blade with a 60" wood handle.

Part Code	Description/Size	Contr Price	Approx Wt
T-HM7	Mortar Hoe	\$39.00	3 lb

12. Reload Reel

Yellow reload reel with line, designed with a thumb brake and auto winder.

Part Code	Description/Size	Contr Price	Approx Wt
T-RRY	500' Roll #18 Braid	\$17.95	1 lb

13. Benjamin Obdyke Home Slicker® Stone & Stucco NEW!

Home Slicker® Stone & Stucco is the only vertically channeled rainscreen that has been specifically designed for use with manufactured stone, natural stone, stucco, and masonry applications.

Part Code	Qty/Skid	Size	Description	Contr Price	Approx Wt
W-HSST	9	39"x61.5' 200 sq ft	Stone & Stucco Rainscreen 6 mil	\$137.45	16 lbs
NS W-HS10ST	9	39"x38.5' 125 sq ft	Stone & Stucco Rainscreen 10 mil	\$113.25	25 lbs

NS=Not shown.



PERMALATH® GLASS FIBER LATH FOR STUCCO AND STONE

*Now Available to
Everyone, Nationally
Through Wind-lock®.*

PermaLath® is an open weave, corrosion-free, three-dimensional, self-furring, glass fiber reinforcing lath.

FEATURES AND BENEFITS

Non Metallic

Will not rust; ideal for coastal applications

Pliable, with No Sharp Edges

Safer and easier to cut and handle

Non-Directional

Can be applied vertically or horizontally

Wide Rolls

Fewer overlaps required to give better coverage

Three-Dimensional Profile

Self-furring, excellent mechanical key using traditional fastening procedures

Low Profile on Overlaps

Overlaps are easily feathered, eliminating shadowing

Alkali Resistant

Long-term durability and performance

Packaged in Lightweight Rolls

Application time/labor savings/storage

PermaLath® Glass Fiber Lath

PermaLath® is a nominal 1/8" thick glass fiber reinforcing lath designed for use with cementitious exterior wall coatings manufactured in accordance with ICC-ES AC-11 at a maximum thickness of 3/8" to 1/2". PermaLath® provides keying and continuous reinforcement for stucco used on vertical wall applications with solid backing.

Part Code	Qty	Size	Description	Contr Price	Approx Wt
I-PL	1 Roll	39" x 150'	1/8" Fiberglass Lath 487.5 sq ft	CALL	16 lb

*Note: 20 Rolls per Skid 39" x 150', 1/8" Fiberglass Lath
9,750 sq ft, 375 lb per skid.*

PermaLath® 1000 Glass Fiber Lath

PermaLath® 1000 is a nominal 1/4" thick glass fiber reinforcing lath designed for use with cementitious exterior wall coatings (traditional stucco) at a maximum thickness of 1/2" to 7/8". PermaLath® 1000 can also be used as a mortar base for lightweight veneer facing, such as stone veneer.

Part Code	Qty	Size	Description	Contr Price	Approx Wt
I-PL1000	1 Roll	39" x 150'	1/4" Fiberglass Lath 487.5 sq ft	CALL	31 lb

*Note: 8 Rolls per Skid 39" x 150', 1/4" Fiberglass Lath
3,900 sq ft, 303 lb per skid.*



1

NEW!

2



3

NEW!

2

NEW!

3



4

NEW!

BENJAMIN OBDYKE HOME SLICKER® AND BLOCKADE™

1. Home Slicker® Stone & Stucco **NEW!**

The only vertically channeled rainscreen that has been specifically designed for use with manufactured stone, natural stone, stucco and masonry applications. Each roll contains the patented Home Slicker® three-dimensional matrix bonded to a fabric which prevents mortar from entering the wall cavity during cladding installation. This product installs with the fabric facing outward.

Part Code	Qty/Skid	Size	Description	Contr Price	Approx Wt
W-HSST	16	39" x 61.5' 200 sq ft	Stone & Stucco Rainscreen 6 mil	\$137.45	16 lb
NS W-HS10ST	16	39" x 38.5' 125 sq ft	Stone & Stucco Rainscreen 10 mil	\$113.25	25 lb

NS=Not shown.

2. Home Slicker® Plus Typar® **NEW!**

A cost-effective, labor and material saving, moisture eliminating rainscreen combined with a water resistive barrier. Each roll contains the patented Home Slicker® three-dimensional matrix bonded to Typar®, the premium residential and commercial grade housewrap.

Part Code	Qty/Skid	Size	Description	Contr Price	Approx Wt
W-HSPT	16	39" x 61.5' 200 sq ft	Plus Typar Rainscreen 6 mil	\$137.45	15 lb
NS W-HS10PT	16	39" x 38.5' 125 sq ft	Plus Typar Rainscreen 10 mil	\$113.25	15 lb

NS=Not shown.

3. Home Slicker® **NEW!**

The unique, vertically-channeled, three-dimensional matrix of the original Home Slicker® provides a continuous space for drainage and drying, a thermal break and pressure equalization—eliminating the threat of trapped moisture. Home Slicker® 10 is designed to meet the 10mm code requirements in Canada.

Part Code	Qty/Skid	Size	Description	Contr Price	Approx Wt
W-HS	16	39" x 46.5' 150 sq ft	Rainscreen 6 mil	\$88.05	10 lb
NS W-HS10N	16	39" x 38.5' 125 sq ft	Rainscreen 10 mil	\$86.30	8 lb

NS=Not shown.

4. Benjamin Obdyke Blockade™ **NEW!**

Designed specifically for use in brick wall cavities, the entangled matrix design of the Blockade™ Mortar Deflection System blocks mortar from clogging the weep holes and allows excess moisture to flow freely out of the wall cavity. The result is a brick wall that is built to stand the test of time and remains free from the deteriorating effects of mold and mildew.

Part Code	Qty/Skid	Size	Description	Contr Price	Approx Wt
W-BA80	16	50'x10"x.80"	80 Mortar Deflection .80" thick	\$37.50	5 lb
W-BA150	16	50'x10"x1.5"	80 Mortar Deflection 1.5" thick	\$56.35	4 lb



1

NEW!

2



3

NEW!

2

NEW!

3



4

NEW!

BENJAMIN OBDYKE HOME SLICKER® AND BLOCKADE™

1. Home Slicker® Stone & Stucco **NEW!**

The only vertically channeled rainscreen that has been specifically designed for use with manufactured stone, natural stone, stucco and masonry applications. Each roll contains the patented Home Slicker® three-dimensional matrix bonded to a fabric which prevents mortar from entering the wall cavity during cladding installation. This product installs with the fabric facing outward.

Part Code	Qty/Skid	Size	Description	Contr Price	Approx Wt
W-HSST	16	39" x 61.5' 200 sq ft	Stone & Stucco Rainscreen 6 mil	\$137.45	16 lb
NS W-HS10ST	16	39" x 38.5' 125 sq ft	Stone & Stucco Rainscreen 10 mil	\$113.25	25 lb

NS=Not shown.

2. Home Slicker® Plus Typar® **NEW!**

A cost-effective, labor and material saving, moisture eliminating rainscreen combined with a water resistive barrier. Each roll contains the patented Home Slicker® three-dimensional matrix bonded to Tybar®, the premium residential and commercial grade housewrap.

Part Code	Qty/Skid	Size	Description	Contr Price	Approx Wt
W-HSPT	16	39" x 61.5' 200 sq ft	Plus Typar Rainscreen 6 mil	\$137.45	15 lb
NS W-HS10PT	16	39" x 38.5' 125 sq ft	Plus Typar Rainscreen 10 mil	\$113.25	15 lb

NS=Not shown.

3. Home Slicker® **NEW!**

The unique, vertically-channeled, three-dimensional matrix of the original Home Slicker® provides a continuous space for drainage and drying, a thermal break and pressure equalization—eliminating the threat of trapped moisture. Home Slicker® 10 is designed to meet the 10mm code requirements in Canada.

Part Code	Qty/Skid	Size	Description	Contr Price	Approx Wt
W-HS	16	39" x 46.5' 150 sq ft	Rainscreen 6 mil	\$88.05	10 lb
NS W-HS10N	16	39" x 38.5' 125 sq ft	Rainscreen 10 mil	\$86.30	8 lb

NS=Not shown.

4. Benjamin Obdyke Blockade™ **NEW!**

Designed specifically for use in brick wall cavities, the entangled matrix design of the Blockade™ Mortar Deflection System blocks mortar from clogging the weep holes and allows excess moisture to flow freely out of the wall cavity. The result is a brick wall that is built to stand the test of time and remains free from the deteriorating effects of mold and mildew.

Part Code	Qty/Skid	Size	Description	Contr Price	Approx Wt
W-BA80	16	50'x10"x.80"	80 Mortar Deflection .80" thick	\$37.50	5 lb
W-BA150	16	50'x10"x1.5"	80 Mortar Deflection 1.5" thick	\$56.35	4 lb