

WIND-LOCK® | WHAT YOU NEED. WHEN YOU NEED IT.

WHAT YOU NEED



WIND-LOCK® | 800-872-5625 | WWW.WIND-LOCK.COM | 2010



WHEN YOU NEED IT

2010

We're proud to be an active member of the following organizations.



Join Us on These Social Networks

Wind-lock® is now on Twitter, Facebook and YouTube. That's three more ways for you to get a jump on great discounts, special offers and a wide range of labor-saving products and videos. Check us out online at www.wind-lock.com and access the network of your choice.



Customer Service The Wind-lock® Customer Sales Support Team is available Monday through Thursday, 8:00 am to 6:00 pm and Friday, 8:00 am to 5:00 pm Eastern Standard Time. For more information, call 1-800-872-5625, fax: 1-800-854-6614 or visit www.wind-lock.com

Pricing All pricing is suggested retail and applies only to the continental United States. We make every effort to assure that our products and pricing are published as accurately as possible. In the event an error is made, we reserve the right to correct it.

Warranty All Wind-lock products are manufactured in accordance with a strict quality assurance program. They are warranted to be free from manufacturing defects and will perform as represented.

Return Policy No merchandise may be returned without a return authorization number from the Wind-lock Credit and Return Department. If the return is authorized, transportation charges must be prepaid. If goods are found defective, we will replace them free of charge.

Tools found abused will be repaired and returned only at buyer's written request. We will not be responsible for any merchandise returned that has been out of the factory 12 months or longer. Merchandise that has been discontinued cannot be returned.

Any and all portions of this catalog may not be reproduced in any way without written consent from Wind-lock. Technical data, photos and illustrations represent the product offered at time of printing. Due to continuous product improvement, items may change. Refer to www.wind-lock.com for the latest information.



1055 Leisz's Bridge Road, Leesport, PA 19533
Phone: 1-800-872-5625 • Fax: 1-800-854-6614
E-mail: wlsupport@wind-lock.com • Web: www.wind-lock.com

OUR FOCUS IS YOUR SUCCESS

Wind-lock is more than quality tools and accessories.

Wind-lock is all about service, including the proven ability to get you what you need, when you need it. We've provided the right resources at the right time for more than 20 years, and as our lineup of products continues to evolve, our commitment to customer success will remain as strong as ever.

Table of Contents

EIFS/STUCCO/STONE VENEER SOLUTIONS
page 4

ICF & SIP BUILDING SOLUTIONS
page 56

WEATHERIZATION SOLUTIONS
page 78

STEALTH ACCESS PANELS
page 86

BLACK LAB APPAREL™ & PROMOTIONS
page 88

INDEX
page 90

Our *Smart Stock* program helps you save space in your warehouse and stocking costs in your budget.

Smart Stock Program



Stock to Dock Shipping Guarantee

Products highlighted in yellow are guaranteed to ship within 24 hours or freight costs are FREE! Larger orders may require additional lead times. Call 800-872-5625 for details.

EIFS/STUCCO/ STONE VENEER SOLUTIONS

Exterior Insulation and Finish Systems (EIFS) currently comprise 30% of the commercial exterior wall market. With today's increased emphasis on energy efficiency, a building envelope incorporating an EIF System provides tremendous insulating value, while meeting or exceeding the demands of current regulatory requirements. Wind-lock® continues to support successful EIFS projects with superior products like Wind-Devil® fasteners and efficient tools for securing insulation board with adhesive and/or mechanical attachments, embedding fiberglass mesh and base coating. Wind-lock also offers a complete range of products for applying stucco, stone veneer and finish coatings.

6	FASTENING		WIND-DEVIL® 2 PAGE 6
14	HOT KNIVES		HOT KNIVES PAGE 14
17	KNIVES AND BLADES		
20	FOAM AND FOAM GUNS		FOAM2FOAM® PAGE 20
22	WATER MANAGEMENT		
26	CAULKING ACCESSORIES		
27	RASPS AND ACCESSORIES		
30	TROWELS		COMFORT-SOFT™ PAGE 30
38	FLOATS		FLOATS PAGE 38
41	DARBIES/HAWKS		
42	BUCKET ACCESSORIES		BUCKET DREDGER PAGE 42
43	MIXING AND SPRAYING TOOLS		
44	TAPES AND FILMS		RED STUCCO TAPE PAGE 44
46	FOAM CUTTING EQUIPMENT		
48	CLEAN-UP		
50	CHEMICALS		
51	STUCCO AND PLASTER ACCESSORIES		
52	STONE VENEER TOOLS		PERMALATH® PAGE 54
54	PERMALATH® GLASS FIBER LATH		
55	HOME SLICKER® AND BLOCKADE™		

HURRY UP IS NO HASSLE

With responsive service representatives, our *Stock to Dock* shipping guarantee and a customer sales team that knows all the availability and delivery details for our entire inventory, we can help you meet the tightest deadlines and toughest project cycle challenges. Want expedited shipping, custom orders, special handling or other delivery options to help you get what you need? No problem. And we offer accuracy and smart insights as well as quick delivery. The Wind-lock team can help you at any point in a project's life, from selection recommendations to field support and troubleshooting.



Wind-lock
CORPORATION

...your partner in EIFS

Proud member of

EIFS Alliance

AWC

EIMA

Member of
The Fastener Group

Wind Devil
2
Patent #5,626,451

The most advanced fastening system available!

1000 unassembled Wind-Devil 2" plates

Wind-lock
CORPORATION

wind-lock.com

your partner in EIFS



WIND-DEVIL® 2

EXCLUSIVE PRODUCT

*For Nearly 3 Decades,
Still The Most Trusted
Mechanical Fastening System!*



**Stock to Dock
Shipping Guarantee**

Products highlighted in yellow are guaranteed to ship within 24 hours or freight costs are **FREE!** Larger orders may require additional lead times. Call for details.

The industry-leading, two-inch diameter Wind-Devil® 2 is by far the most popular and technologically advanced EIFS mechanical fastening system on the market. The patented “bullseye” closure arms allow easy, efficient backing out of any screw, saving time and money.

The Wind-Devil® 2 is designed and engineered for use with polymer based (PB) EIFS (Exterior Insulation and Finish Systems). It allows the attachment of EPS insulation to a variety of substrates, including wood, lite metal, steel and masonry. Our witnessed, negative wind-load testing (ASTM-E330) continues to set the industry standard for attaching EIFS.

The Wind-Devil® 2 fastening system is engineered to be utilized in wood, lite metal, steel and masonry substrates and can be applied in any weather condition.

1. Wind-Devil® 2 Plates

Call your local distributor for pricing.

Part Code	Qty/Box	Description	Approx Wt/Box
WD-2PLATE	1000	Wind-Devil 2 Plates	10 lb
WD2-PK	500	Wind-Devil 2 Pack	5 lb

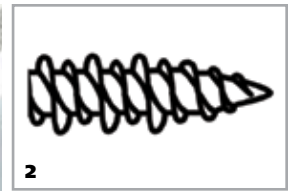

WIND-DEVIL® 2 FASTENERS SERIES SELECTION

Longer length fasteners are available. See Long-lock, page 8.

2. Wood and Lite Metal Series Assembled Fasteners (WLMT)

Assembled fastener and plate for use with dimensional lumber, plywood type sheathings and metal sidings, 20 to 26 gauge.

Part Code	Qty/Box	Insulation Thickness	Screw Size	Approx Wt/Box
WLMT-1	1000	1"	#7 x 1-5/8"	16 lb
WLMT-2	1000	1-1/2"	#8 x 2"	19 lb
WLMT-3	1000	2"	#8 x 2-1/2"	21 lb
WLMT-4	1000	2-1/2"	#8 x 3"	22 lb
WLMT-5	1000	3"	#8 x 4"	25 lb
WLMT-7	500	3-1/2"-4-1/2"	#10 x 5"	20 lb
WLMT-8	500	5"-5-1/2"	#10 x 6"	22 lb

Wood and Lite Metal Zinc Screw Series Assembled Fasteners (GWLMT)

Assembled fastener and plate for use with dimensional lumber, plywood type sheathings and metal sidings, 20 to 26 gauge, using our zinc plated UZWLM screws.

Part Code	Qty/Box	Insulation Thickness	Screw Size	Approx Wt/Box
GWLMT-1	1000	1"	#6 x 1-5/8"	16 lb
GWLMT-2	1000	1-1/2"	#6 x 2"	18 lb
GWLMT-3	1000	2"	#8 x 2-5/8"	21 lb
GWLMT-4	1000	2-1/2"	#8 x 3"	22 lb
GWLMT-5	1000	3"	#10 x 4"	25 lb

Wood Zinc Screw Series Assembled Fasteners (GWT)

Assembled fastener and plate for use with dimensional lumber and plywood type sheathings using our zinc plated UZW screws.

Part Code	Qty/Box	Insulation Thickness	Screw Size	Approx Wt/Box
GWT-1	1000	1"	#6 x 1-5/8"	16 lb
GWT-2	1000	1-1/2"	#7 x 2"	19 lb
GWT-3	1000	2"	#8 x 2-1/2"	21 lb
GWT-4	1000	2-1/2"	#8 x 3"	22 lb
GWT-5	1000	3"	#10 x 4"	25 lb

3. Steel Series Assembled Fasteners (ST)

Assembled fastener and plate for use with 12 to 20 gauge. Does not take into account sheathing thickness.

Part Code	Qty/Box	Insulation Thickness	Screw Size	Approx Wt/Box
ST-1	1000	1"	#6 x 1-5/8"	16 lb
ST-2	1000	1-1/2"	#6 x 2"	18 lb
ST-3	1000	2"	#8 x 2-5/8"	22 lb
ST-4	1000	2-1/2"	#8 x 3"	24 lb
ST-5	1000	3"	#10 x 4"	32 lb
ST-6	1000	3-1/2"-4"	#10 x 4-3/8"	34 lb
ST-7	500	4"-4-1/2"	#10 x 5"	20 lb
ST-8	500	5"-5-1/2"	#10 x 6"	23 lb
ST-9	500	6"-6-1/2"	#10 x 7"	26 lb
ST-10	500	7"-7-1/2"	#10 x 8"	27 lb

4. Masonry Series Assembled Fasteners (MT)

Assembled fastener and plate for use with concrete and other unit masonry. 5 drill bits per 1000 included.

Part Code	Qty/Box	Insulation Thickness	Screw Size	Approx Wt/Box
MT-1	1000	1" only	3/16" x 1-3/4"	21 lb
MT-2	1000	1-1/2"	3/16" x 2-1/4"	26 lb
MT-3	1000	2"	3/16" x 2-3/4"	26 lb
MT-4	1000	2-1/2"	3/16" x 3-1/4"	28 lb
MT-5	1000	3"	3/16" x 4"	31 lb

5. Masonry Expandable Series Assembled Fasteners (MET)

Assembled, expandable fastener and plate for use with concrete block, concrete and other unit masonry. Drill bit not included. For MET-1-MET-3 use bit M-S166; for MET-1-MET-7 use bit M-S1612. See page 11 for ordering information.

Part Code	Qty/Box	Insulation Thickness	Screw Size	Approx Wt/Box
MET-1	1000	1" only	3/16" x 2-1/4"	25 lb
MET-2	1000	1-1/2"	3/16" x 2-1/2"	26 lb
MET-3	1000	2"	3/16" x 3"	28 lb
MET-4	1000	3"	3/16" x 4"	30 lb
MET-5	1000	3-1/2"	3/16" x 4-1/2"	19 lb
MET-6	500	4"	#10 x 5"	21 lb
MET-7	500	5"	#10 x 6"	22 lb
MET-8	500	6"	#10 x 7"	25 lb
MET-9	500	7"	#10 x 8"	28 lb

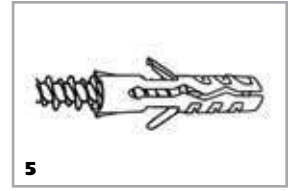
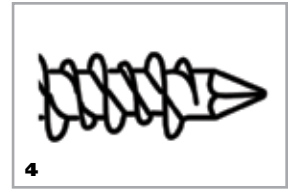
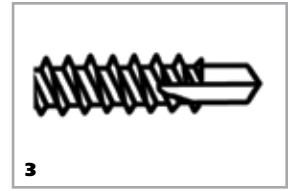

WIND-DEVIL® 2 TECHNICAL DATA

WIND-LOAD TEST DATA

Wind-Devil® 2

All measurements shown are ultimate pounds per foot.

EPS Thickness	Pattern A	Pattern B	Pattern C
1"	107	88	85
1-1/2"	130	114	103
2"	144	129	124

Witness test reports available.

GENERAL CORROSION DATA

Salt Spray (ASTM-B117)

Finish	Hours to Initial (%) Signs of Red Rust	Hours and Red Rust (%) at Test Conclusion
Phosphate and oil	24 (5% or less)	240 (90-100%)
.0003" electro zinc	48 (5% or less)	240 (75-100%)
.001" hot dip galvanized	98 (5% or less)	320 (75-100%)
Wind-lock® CCS Coating	192 (5% or less)	720 (50-100%)

FASTENER PULLOUTS

WLMT Series

Dimensional lumber/wood sheathings.

Penetration dimensional lumber	1/2"	3/4"	1"	1-1/4"	1-1/2"
Pullout strength	183	304	441	652	731

WLMT Series

Lite gauge metal siding.

Nominal gauge	26	25	22	20
Lite Metal pullout strength	*	178	244	277

*Consult Wind-lock® for pullout (through penetration 1/4" min.).

ST Series

Steel/steel studs.

Nominal gauge	24	22	20	18	16	14	12
Steel pullout strength	*	211	296	471	679	847	1225

*Consult Wind-lock® for pullout (through penetration 1/4" min.).

MT Series

Masonry.

Penetration	1"	1-1/4"	1-1/2"	1-3/4"
Concrete pullout strength	380	580	830	1090
Hollow block pullout strength	229	416†	452†	521†

†Denotes solid material.

MET Series

Masonry expandable.

Concrete pullout strength	378
Hollow block pullout strength	333

Pullout strengths shown are ultimate values. An appropriate factor of safety must be applied by the user to obtain allowable limits for design. Masonry must be pre-drilled 1/2" deeper than fastener penetration. Hardness of masonry varies and may require a non-standard drill bit. Please consult Wind-lock® for assistance in proper drill bit size. Consult system manufacturer for specific requirements.

TYPICAL WIND-DEVIL® 2 FASTENING PATTERNS

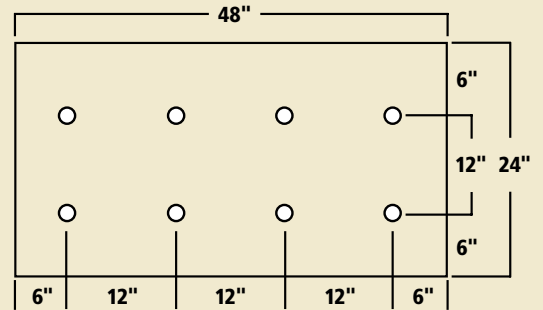

Pattern A

Wood sheathing, masonry and some metal sidings.

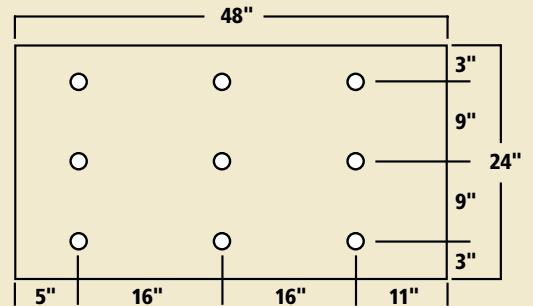

Pattern B

16" O.C. stud fastening pattern.

NOTE: For pattern "B" stud fastening over non-screwable sheathing, fastener spacing does not exceed 16" O.C. variable not to exceed 11".

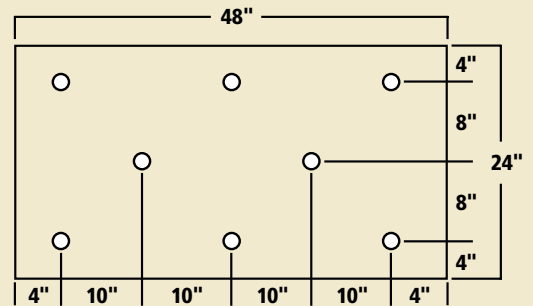

Pattern C

Wood sheathing, masonry and some metal sidings.

WIND-DEVIL® 2 SELECTION GUIDE

Insulation Thickness	Wood/Lite Metal Series**	Steel Series	Masonry Series
1"	WLMT-1	ST-1*	MT-1
1-1/2"	WLMT-2	ST-2*	MT-2
2"	WLMT-3	ST-3*	MT-3
2-1/2"	WLMT-4	ST-4*	MT-4
3"	WLMT-5	ST-5*	MT-5
3-1/2"	WLMT-7	ST-6*	
4"	WLMT-7	ST-7*	
4-1/2"	WLMT-7	ST-7*	
5"	WLMT-8	ST-8*	
5-1/2"	WLMT-8	ST-8*	

For virtually any size fastener, contact Wind-lock® or refer to the Long-lock section, Page 8.

* Sizes are for direct application into steel and do not take into account the sheathing. For 1/2" and 5/8" sheathing, move fastener selection to next higher size.

** See page 5 for additional wood (GWT) and lite metal (GWLMT) fasteners.

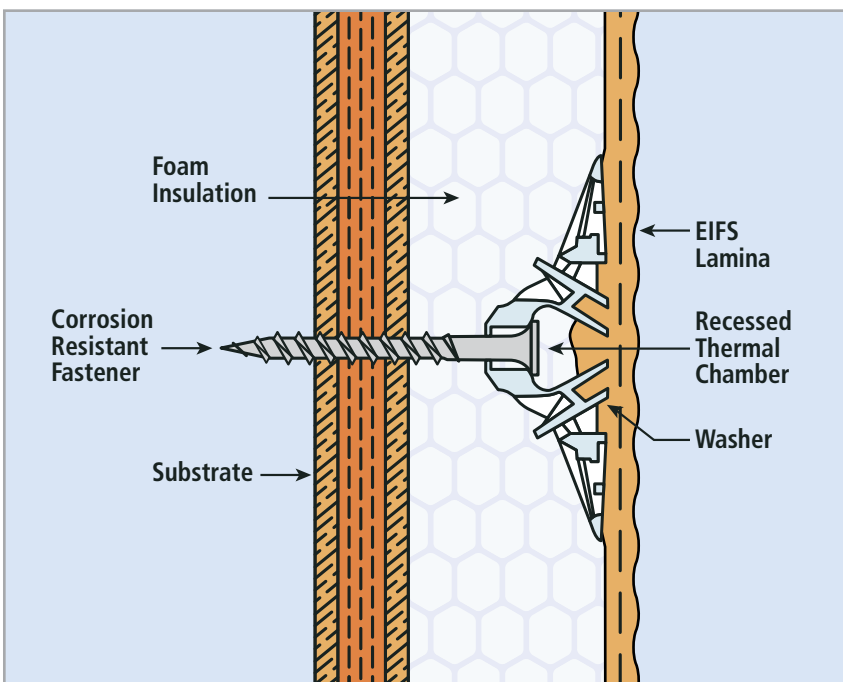

Why The Wind-Devil® 2 is Best!

- Comprehensive witness testing
- Over 20 years of proven performance
- EIFS industry approved
- Significant negative wind-load resistance
- Recessed thermal chamber helps prevent thermal bridging
- Patented closure arms allow for easy “backing” out
- Installation of the Wind-Devil® 2 compresses the foam under the washer forming a “gasket” around the fastener. This gasketing action diverts moisture from the fastener.



OTHER FASTENERS



1. ULP-302 Series Selection

The ULP-302 and ULP-402 are engineered to attach PermaLath® 17, 20 gauge stucco netting, as well as 2.5 and 3.4 metal lath (hard coat stucco systems). NOT for use with PB EIFS. For standard PB applications with the thermal recessed chamber, refer to Wind-Devil® 2 and Long-lock fasteners.

Engineered Features

- 1-3/4" diameter
- Made of high-grade polypropylene plastic
- Unique design allows plate to flatten out in application
- Large ribs stiffen plate, limit deflection
- 16 keyholes allow for mechanical locking of base coat
- Can be screw fastened, nailed or shot
- Engineered "flash" allows for pre-assembly of screw fasteners

Consult system manufacturer for specific requirements.

Wood/Lite Metal Series

Part Code	Qty/Box	Insulation Thickness	Screw Size	Approx Wt/Box
ULP-3WLM1	1000	3/4"	#7 x 1-5/8"	13 lb
ULP-3WLM2	1000	1"	#8 x 2"	15 lb
ULP-3WLM3	1000	1-1/2"	#8 x 2-1/2"	17 lb
ULP-3WLM4	1000	2"	#8 x 3"	19 lb
ULP-3WLM5	1000	3"	#8 x 4"	21 lb

Steel Series

Part Code	Qty/Box	Insulation Thickness	Screw Size	Approx Wt/Box
ULP-3S1	1000	3/4"	#6 x 1-5/8"	12 lb
ULP-3S2	1000	1"	#6 x 2"	14 lb
ULP-3S3	1000	1-1/2"	#8 x 2-5/8"	18 lb
ULP-3S4	1000	2"	#8 x 3"	19 lb
ULP-3S5	1000	3"	#10 x 4"	27 lb

2. ULP-302 Plate

Part Code	Qty/Box	Description	Approx Wt/Box
ULP-302	1000	Plates	6 lb

3. ULP-402 Series Selection

Engineered Features

- 1-3/4" diameter
- Made of high-grade polypropylene plastic
- Pre-spotting central stem/tab allows for quick and easy pre-spotting into insulation board
- Large ribs stiffen plate, limit deflection
- 16 keyholes allow for mechanical locking of base coat
- The ULP-402 is unassembled and can be utilized with Wind-lock® highly coated exterior fasteners

Consult system manufacturer for specific requirements.

Part Code	Qty/Box	Approx Wt/Box
ULP-402	1000	6 lb

4. Long-lock Fasteners

Use these for all of your thick foam fastening needs, such as: cornice details, arches, columns, custom parapet shapes and quoins. All fasteners come fully assembled.

Engineered Features

- 1-3/4" diameter
- Finger closure and recessed fastener chamber
- Utilized for thicker insulation

Consult system manufacturer for specific requirements.

WLM—Wood/Lite Metal/Masonry Screws

Hardness of masonry varies and may require a non-standard drill bit. Please consult Wind-lock® for assistance in proper drill bit size. Includes one drill bit per 200 pieces.

Part Code	Qty/Box	Insulation Thickness	Screw Size	Approx Wt/Box
WLM-7	100	4"	#14 x 5"	5 lb
WLM-8	100	5"	#14 x 6"	5 lb
WLM-9	100	6"	#14 x 7"	6 lb
WLM-10	100	7"	#14 x 8"	7 lb
WLM-11	100	8"	#14 x 9"	8 lb
WLM-12	100	9"	#14 x 10"	8 lb
WLM-13	100	10"	#14 x 11"	9 lb
WLM-14	100	11"	#14 x 12"	10 lb
WLM-15	100	12"–13"	#14 x 14"	12 lb

For even longer fasteners, please contact Wind-lock®



Stock to Dock Shipping Guarantee

Products highlighted in yellow are guaranteed to ship within 24 hours or freight costs are **FREE!** Larger orders may require additional lead times. Call for details.

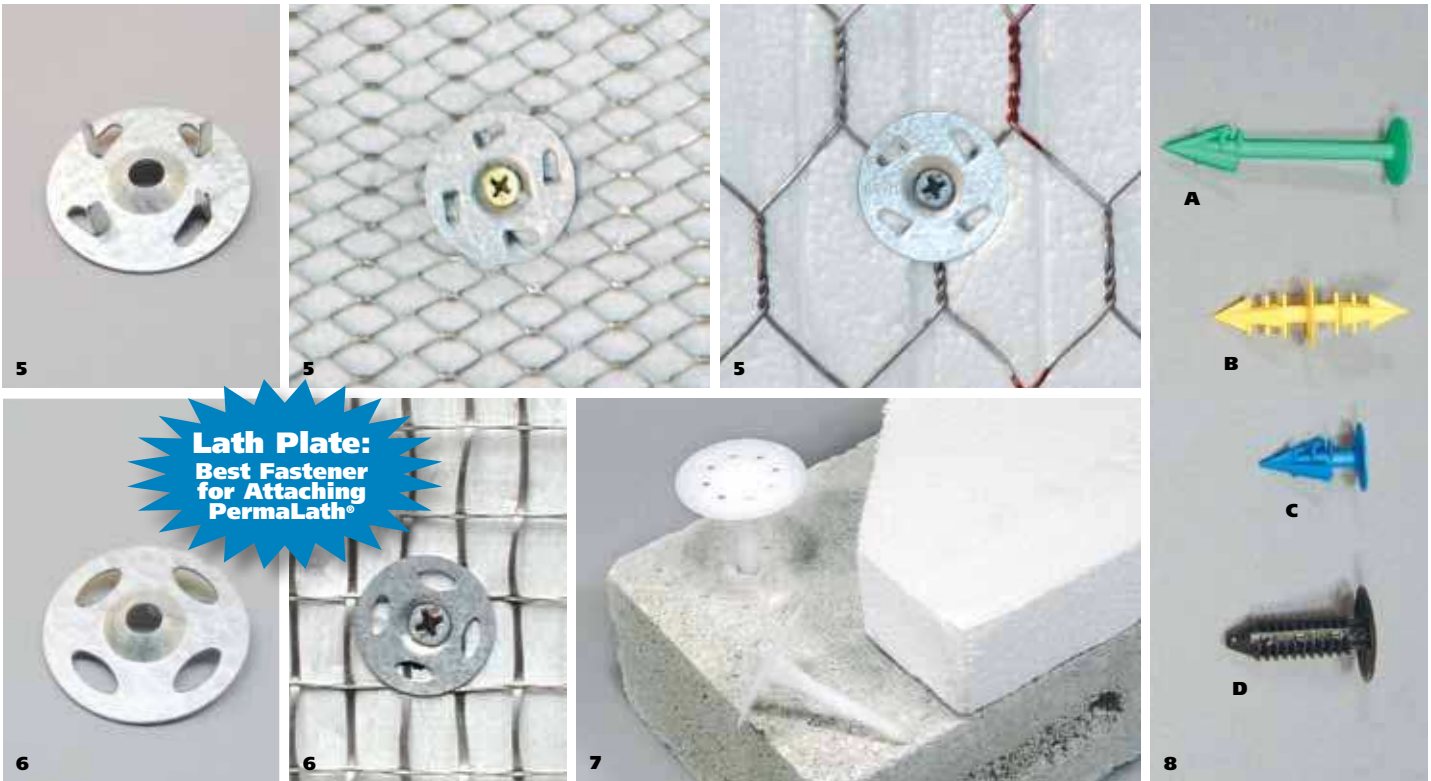

**Lath Plate:
Best Fastener
for Attaching
PermaLath®**

5. Lath-Lock

Designed to be used with Polymer Modified (PM) Hard Coat EIFS, insulated stucco systems, stucco systems utilizing expanded metal lath or stucco wire over rigid insulations.

Engineered Features

- 1-1/4" diameter, G-90 galvanized steel
- Flat profile
- Positive attachment
- Tabs reduce spin in insulation board
- Reversed arm creates non-stacking plate
- Recessed center chamber allows for flush seating of fastener
- Turned tabs allow for pre-spotting
- Smooth edges
- Can be screw fastened, nailed or shot

Consult system manufacturer for specific requirements.

Part Code	Qty/Box	Approx Wt/Box
LATH-LOCK	1000	9 lb

6. Lath-Plate (Legless)

Legless Lath-Plate is perfect for stone veneer and thin coat stucco utilizing PermaLath®.

Engineered Features

- 1-1/4" diameter, G-90 galvanized steel
- Flat profile
- Positive attachment
- Recessed center chamber allows for flush seating of fastener
- Smooth edges
- Can be screw fastened, nailed or shot

Consult system manufacturer for specific requirements.

Part Code	Qty/Box	Approx Wt/Box
LATH-PLATE (Legless)	1000	9 lb

7. Congrip Masonry Fasteners

Made of polypropylene with keyholes for locking in the base coat. Simply drill a pilot hole and hammer into the concrete. Requires 5/16" drill bit.

Part Code	Qty/Box	Insulation Thickness	Description	Approx Wt/Box
W-MCG0	250	3/4"-1"	2" Masonry Walgrip	4 lb
W-MCG1	250	1-1/2"	2-3/4" Masonry Walgrip	4 lb
W-MCG2	250	2"	3-1/2" Masonry Walgrip	5 lb

Longer sizes available, call for details.

8. Foam Tacs

Temporary fastening system used in conjunction with adhesive attachment of stucco trims and accessories.

Part Code	Qty/Bag	Description	Approx Wt/Bag
A ARROW-TAC	250	1-3/4" Arrow Foam Tac	1 lb
B INSUL-TAC	250	1-1/2" Insul Foam Tac	1 lb
C TRIM-TAC	250	3/4" Trim Foam Tac	1 lb
D M-TT1	1000	1" Trim Tab	2 lb
D M-TT158	1000	1-5/8" Trim Tab	3 lb

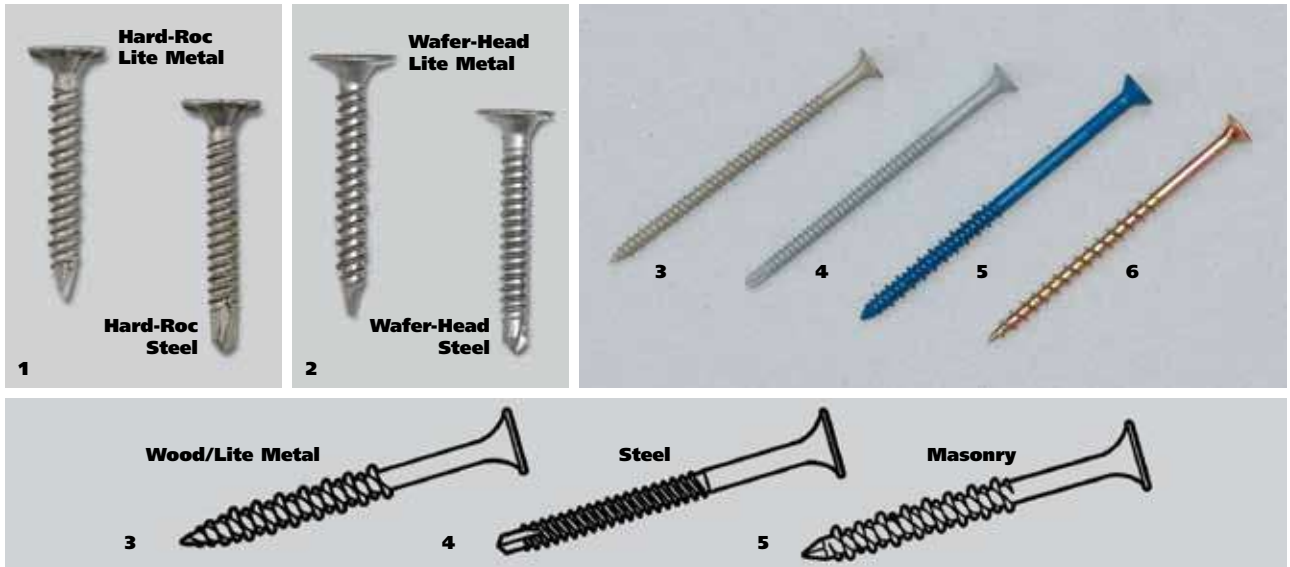

SCREWS

All wood/lite metal and steel fasteners are self-tapping. All screws except for the economy wood fasteners (UZW) are highly coated, meeting the Wind-lock® Corrosion Coating Standard.

1. Hard-Roc Sheathing Fasteners (F-HR)

Part Code	Qty/Box	Screw Size	Approx Wt/Box
F-HR114	1000	#9 x 1-1/4"	6 lb
F-HR158	1000	#9 x 1-5/8"	7 lb
F-HR114S	1000	#8 x 1-1/4"	6 lb
F-HR158S	1000	#8 x 1-5/8"	7 lb

2. Wafer-Head Sheathing Fasteners (F-WH)

Part Code	Qty/Box	Screw Size	Approx Wt/Box
F-WH114	1000	#8 x 1-1/4"	6 lb
F-WH158	1000	#8 x 1-5/8"	7 lb
F-WH114S	1000	#10 x 1-1/4"	6 lb
F-WH158S	1000	#8 x 1-5/8"	7 lb

3. Wood/Lite Metal Fasteners (UWLM)

Part Code	Qty/Box	Screw Size	Approx Wt/Box
UWLM-1	1000	#7 x 1-5/8"	6 lb
UWLM-2	1000	#8 x 2"	8 lb
UWLM-3	1000	#8 x 2-1/2"	9 lb
UWLM-4	1000	#8 x 3"	11 lb
UWLM-5	1000	#8 x 4"	13 lb
UWLM-7	1000	#10 x 5"	22 lb
UWLM-8	1000	#10 x 6"	27 lb

4. Steel Fasteners (US)

Part Code	Qty/Box	Screw Size	Approx Wt/Box
US-1	1000	#6 x 1-5/8"	5 lb
US-2	1000	#6 x 2"	8 lb
US-3	1000	#8 x 2-5/8"	11 lb
US-4	1000	#8 x 3"	13 lb
US-5	1000	#10 x 4"	22 lb
US-6	1000	#10 x 4-3/8"	23 lb
US-7	1000	#10 x 5"	26 lb
US-8	1000	#10 x 6"	32 lb

Longer sizes available, call for details.

5. Tapcon® Masonry Fasteners (UM)

Includes 5 drill bits per 1000 pieces.

Part Code	Qty/Box	Screw Size	Approx Wt/Box
UM-1	1000	3/16" x 1-3/4"	10 lb
UM-2	1000	3/16" x 2-1/4"	12 lb
UM-3	1000	3/16" x 2-3/4"	15 lb
UM-4	1000	3/16" x 3-1/4"	17 lb
UM-5	1000	3/16" x 4"	21 lb

Longer sizes available, call for details.

6. Economy Wood Fasteners (UZW)

Zinc coated for use with dimensional lumber and plywood type sheathings.

Part Code	Qty/Box	Screw Size	Approx Wt/Box
UZW-1	1000	#6 x 1-5/8"	6 lb
UZW-2	1000	#7 x 2"	8 lb
UZW-3	1000	#8 x 2-1/2"	9 lb
UZW-4	1000	#8 x 3"	11 lb
UZW-5	1000	#10 x 4"	23 lb

7. Economy Wood and Lite Metal Fasteners (UZWLM)

Zinc coated for use with dimensional lumber, plywood type sheathings and metal sidings, 20 to 26 gauge.

Part Code	Qty/Box	Screw Size	Approx Wt/Box
NS UZWLM-1	1000	#6 x 1-5/8"	6 lb
NS UZWLM-2	1000	#6 x 2"	8 lb
NS UZWLM-3	1000	#8 x 2-5/8"	9 lb
NS UZWLM-4	1000	#8 x 3"	11 lb
NS UZWLM-5	1000	#10 x 4"	23 lb

NS=Not shown.



1

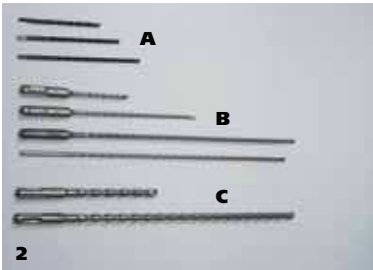

2



3

FASTENING TOOLS

1. Universal Depth Stop

For EIFS applications.

- Works with virtually any screw gun or drill
- Adjustable
- Prevents overdrive
- Provides consistent seating depth
- Hardened steel
- Sealed bearing

Part Code	Description	Contr Price	Approx Wt
M-UNIV	Universal Depth Stop	\$49.95	1 lb

2. Masonry Drill Bits

A For use with hammer drills. Pre-drill pilot holes when working with masonry substrates.

B and **C** SCS carbide-tipped drill bits are specifically designed for Wind-lock® screw-in masonry anchors and used with rotary hammer drills.

Part Code	Bit Size	Usable Length	Usage	Pcs/Pk	Contr Price	Approx Wt
A M-PKMDB35	5/32" x 3-1/2"	2"	MT-1 only	10	\$41.00	1 lb
A M-PKMDB45	5/32" x 4-1/2"	2-3/4"	MT-1-MT-3	10	\$48.00	1 lb
A M-PKMDB55	5/32" x 5-1/2"	3-1/2"	MT-1-MT-5	10	\$53.00	1 lb
B M-S324	5/32" x 4"	2"	MT-1 only	1	\$9.45	1 lb
B M-S327	5/32" x 7"	5"	MT-1-MT-5	1	\$9.85	1 lb
B 5000025	3/16" x 14"	12"	MT-1-MT-12	1	\$16.00	1 lb
B 5000026	3/16" x 12" Straight Shank	12"	MT-1-MT-12	1	\$10.00	1 lb
C M-S166	5/16" x 6"	4"	MET-1-MET-3	1	\$11.95	1 lb
C M-S1612	5/16" x 12"	10"	MET-1-MET-7	1	\$19.20	1 lb

3. Hammer Tackers and Staples

Use for fast attachment of building wraps. Single-handed grip for easy operations. Reliable and durable with no loose parts.

Tackers

Part Code	Description	Contr Price/Pc	Approx Wt/Box
T-HTRR19	Rapid R19	\$26.95	1 lb
T-HTRR11	Rapid R11	\$47.40	1 lb

Staples

Part Code	Description	Contr Price/Pc	Approx Wt/Box
T-STHT19	R19 1/4" staple Box 5,000	\$3.15	1 lb
T-STHT50	R19 1/4" staple Case/48 boxes	\$145.00	1 lb
T-STHT1/4	1/4" staples Box 5,000	\$3.85	1 lb
T-STHT3/8	3/8" staples Box 5,000	\$5.30	1 lb
T-STHT5/16	5/16" staples Box 5,000	\$5.15	1 lb

Kits

Part Code	Description	Contr Price/Pc	Approx Wt/Box
T-KHTR19	R19 Tacker and 1 box of 1/4" staples	\$28.95	2 lb
T-KHTR11	R11 Tacker and 2 boxes of staples 1/4" and 3/8"	\$53.50	3 lb

Industry Exclusive:
Now with a 3 year warranty.



1



2



3

NEW!

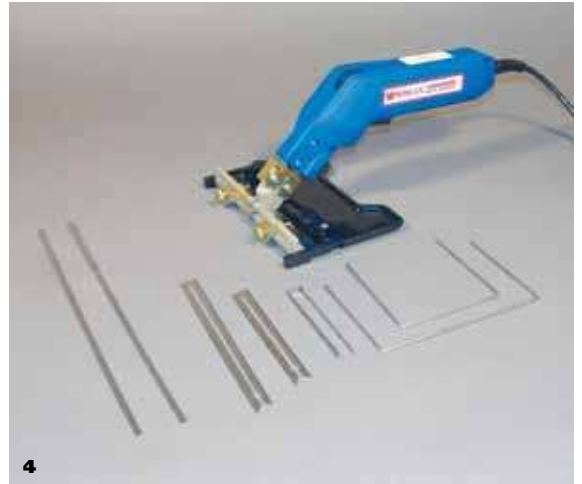

4



5

2-QC HOT KNIFE, KITS AND ACCESSORIES

EXCLUSIVE PRODUCT



Stock to Dock Shipping Guarantee

Products highlighted in yellow are guaranteed to ship within 24 hours or freight costs are **FREE!** Larger orders may require additional lead times. Call for details.

1. 2-QC Knife

Cuts foam clean with no bead dust. Handle stays cool.

KIT INCLUDES: 2-QC Hot Knife and 4" straight blade.

Part Code	Description	Contr Price	Approx Wt
2-QC	Hot Knife Tool Kit	\$250.85	2 lb
2-BQC	Hot Knife Tool Kit and Bag	\$280.05	5 lb

2. 2-QC Hot Knife Kit

For use with Groove Blades.

KIT INCLUDES: 2-QC Hot Knife, 6" sled, 4" straight blade and 2 pieces of 12" flat blade material.

Part Code	Description	Contr Price	Approx Wt
2-QCKIT	Hot Knife Kit with 6" Sled	\$350.95	3 lb
2-BQCKIT	Hot Knife Tool Kit with 6" Sled and Bag	\$379.95	5 lb

3. Ultimate EIFS Kit **NEW!**

Our most complete Hot Knife Kit.

KIT INCLUDES: 2 QC Hot Knife, 6" sled, 4" straight blade, 3/4" x 3/4" V Groove kit, UGZ® hand rasp, Insul-Knife™ with sharpener, 3 cans of F2F® foam gun and can of cleaner, rubber coated gloves and canvas tool bag.

Part Code	Description	Contr Price	Approx Wt
2-UEIFSKIT	Ultimate EIFS Kit	\$525.95	22 lb

4. ICF Kit

Great starter kit.

KIT INCLUDES: 2-QC Hot Knife, 6" sled, 1/2" x 3" square blade, 4" and 6" straight blades, single and double electrical box cutter blades, 2 pieces of 12" flat blade material.

Part Code	Description	Contr Price	Approx Wt
2-ICFKIT	Concrete Forms Kit	\$364.75	3 lb
2-BICFKIT	Concrete Forms Kit (page 13)	\$393.55	5 lb

5. EPS Board Beveler

Part Code	Description	Contr Price	Approx Wt
Q-EPSBB	45° Angle Attachment	\$39.95	2 lb

6. 2-QC Knife Straight Blades

Part Code	Description	Contr Price	Approx Wt
NS Q-SB2	2" Straight Blade 2 pack	\$20.00	1 lb
NS Q-SB4	4" Straight Blade 2 pack	\$24.00	1 lb
NS Q-SB6	6" Straight Blade 2 pack	\$28.00	1 lb

NS=Not shown.
Blade shown in photo number 1.

Buy the Kit and Save!

Also see Applicator Tool Bag Kit on pg. 32.



7. Round Wire Blade Material

Part Code	Description	Contr Price	Approx Wt
Q-RBM243	24" Round Wire Blade Material 3 pack	\$25.95	1 lb

8. Flat Blade Material

Part Code	Description	Contr Price	Approx Wt
Q-SBM123	12" Flat Blade Material 3 pack	\$18.00	1 lb
Q-SBM128	12" Flat Blade Material 8 pack	\$48.00	1 lb
Q-SBMR12	12" Flat Blade Material Roll	\$66.00	1 lb
Q-SBMR24	24" Flat Blade Material Roll	\$119.95	1 lb

9. Hard Wire Benders

Part Code	Description	Contr Price	Approx Wt
W-HWB	Hard Wire Benders	\$15.75	1 lb

10. Hard Wire Cutter

Part Code	Description	Contr Price	Approx Wt
T-HWC63	Hard Wire Cutter	\$57.25	1 lb

11. Replacement Blade Holder Parts

Thumbscrews make blade changing easier.

KIT INCLUDES: Brass plates and 2 thumbscrews.
Sled not included.

Part Code	Description	Contr Price	Approx Wt
2-QCRK	Brass Blade Holder Replacement Parts	\$7.95	1 lb
Q-SLED6RK	Brass Sled Holder Replacement Parts	\$19.50	1 lb

12. Step-Up and Down Transformer 120/220V

International converter.

Part Code	Description	Contr Price	Approx Wt
I-TS4033	Transformer Voltage Converter 120/220V	\$29.95	7 lb

PROPER USE OF THE WIND-LOCK® QC HOT KNIFE



1. How to use the Wind-lock® QC Hot Knife.



4. The versatile blade holders can accept a wide variety of blades and attachments. The QS-50 is shown. 1/2" x 3".



2. The spring-loaded on/off trigger offers you instant power.



5. The blade holders can accept a wide variety of blades and attachments. The Q-SLED6 shown.



3. The dial power control located on the top is for adjustable blade heat control.



6. The Q-SLED6's adjustable blade depth is used for plunge or scooping cuts. The Q-EBX4 (Electrical Box Cutter) is shown.

*Want more cutting power?
Same techniques apply to the
Wind-lock® Super Groover.™
(See page 60)*

Always disconnect power before changing blade.

BEND YOUR OWN BLADES





1 A

B

C



1

D

E



2

F

G



2

H

I

J

K



3

L

M

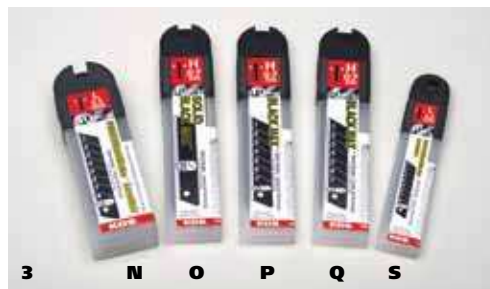

3

N

O

P

Q

S



4



5

KNIVES AND BLADES

1. OLFA

Part Code	Description	Contr Price	Approx Wt
A I-HDUK	Utility Knife—OLFA, Non-Slip, Heavy Duty 1" Blade	\$16.99	1 lb
B I-RHDK	Utility Knife—OLFA, Rubber, Heavy Duty 1" Blade	\$19.99	1 lb
C I-UK	Utility Knife—OLFA, Plastic Knife 3/4" Blade	\$9.45	1 lb
D I-S10PK	Utility Blade—Solid 3/4" Blade, 10 pack	\$9.40	1 lb
E I-HD20PK	Utility Blade—Heavy Duty 1" Blade, 20 pack	\$28.49	1 lb

2. Tajima

Part Code	Description	Contr Price	Approx Wt
F I-TJHDK	Utility Knife—Tajima, 1" Blade, Rock Hard	\$9.75	1 lb
G I-TJUK	Utility Knife—Tajima, 3/4" Wide Blade	\$7.50	1 lb
H I-TJHD20PK	Utility Blade—Tajima, Rock Hard Breakaway 1' Wide Blade	\$18.50	1 lb
I I-TJHD5PK	Utility Blade—Tajima, Rock Hard Breakaway 1' Wide Blade	\$6.90	1 lb
J I-TJ10PK	Utility Blade—Tajima, Endura Breakaway 3/4" Wide Blade, 10 pack	\$6.00	1 lb
K I-TJ50PK	Utility Blade—Tajima, Endura Breakaway 3/4" Wide Blade, 50 pack	\$18.00	3 lb

3. KDS

Part Code	Description	Contr Price	Approx Wt
L I-JBH12	Utility Knife—KDS, Plastic, Heavy Duty	\$8.36	1 lb
MI-LUK19	Utility Knife—KDS, Plastic	\$6.05	1 lb
N I-SHD10PK	Utility Blade—Heavy Duty 1" Blade, 10 pack	\$12.95	1 lb
O I-HD50PK	Utility Blade—Heavy Duty 1" Blade, 50 pack	\$59.50	3 lb
P I-10PK	Utility Blade—Black Breakaway Blade, 10 pack	\$7.50	1 lb
Q I-HD10PK	Utility Blade—Heavy Duty 1" Blade, 10 pack	\$12.75	1 lb
NS R I-HD5PK	Utility Blade—Heavy Duty 1" Blade, 5 pack	\$6.50	1 lb
S I-50PK	Utility Blade—Breakaway Blade, 50 pack	\$35.00	3 lb

NS=Not shown.

4. Ansell Cut Protection Glove

Combining comfort plus the ultimate in cut protection and dexterity—all in one glove—this is the construction glove to be wearing when handling rough, sharp or jagged materials.

Part Code	Description	Size	Contr Price
W-KEVGMD	Blue Kevlar with Stainless Steel Cut Resistant Gloves	Medium	\$20.95
W-KEVGLG	Blue Kevlar with Stainless Steel Cut Resistant Gloves	Large	\$20.95

5. Insul-Knife™

Insul-Knife™ is one of those time-saving tools that you will wonder how you ever lived without. It is perfect for easily cutting all type of insulations including: EPS foam, fiberglass, sponge foam and cotton fiber. It is an excellent tool for trimming unwanted excess foam insulation after it expands and cures.

Part Code	Description	Contr Price
W-INSULKIT	Multipurpose Insulation Kit (Knife and Sharpener)	\$42.95
W-INSULS	Insulation Knife Sharpener	\$10.99

Kit Includes Groove Tool Handle

AESTHETIC GROOVE KITS

To add aesthetic grooves to your EIFS project you will need a 2-QC Hot Knife with the Q-SLED6 groove sled adapter and an aesthetic groove kit. The aesthetic groove kit includes the groove tool handle, three blades and the sleds necessary to complete grooves to the finished dimensions. The dimensions below represent the finished grooves when using a PB EIFS system. Other kits, additional sizes and custom sizes are available, call for details.



Stock to Dock Shipping Guarantee

Products highlighted in yellow are guaranteed to ship within 24 hours or freight costs are **FREE!** Larger orders may require additional lead times. Call for details.

V Groove

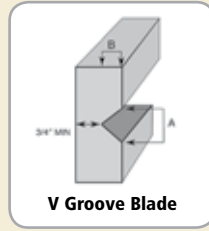

V Groove Blade

V Groove Tool, Blades and Sled Kits

Part Code	Dimensions (A and B)	Contr Price
KV-100	1" x 1/2"	\$39.20
KV-101	1" x 1"	\$40.20
KV-150	1-1/2" x 3/4"	\$41.70
KV-175	1" x 3/4"	\$39.70
KV-200	2" x 1"	\$44.20
KV-5050	1/2" x 1/2"	\$37.20
KV-75	3/4" x 3/8"	\$37.20
KV-7575	3/4" x 3/4"	\$38.20

Angled Groove

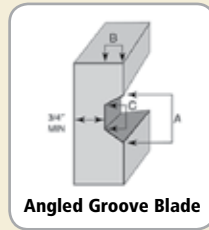

Angled Groove Blade

Angled Groove Tool, Blades and Sled Kits

Part Code	Dimensions (A, B and C)	Contr Price
KA-102	1" x 1/2" x 1/2"	\$39.20
KA-104	1" x 3/4" x 1/4"	\$39.20
KA-152	1-1/2" x 1/2" x 1"	\$40.70
KA-154	1-1/2" x 3/4" x 3/4"	\$40.70
KA-201	2" x 1" x 1"	\$43.70
KA-202	2" x 1/2" x 1-1/2"	\$43.70
KA-204	2" x 3/4" x 1-1/4"	\$43.70
KA-301	3" x 1" x 2"	\$50.70

Beveled Groove

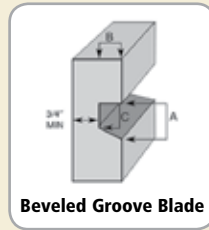

Beveled Groove Blade

Beveled Groove Tool, Blades and Sled Kits

Part Code	Dimensions (A, B and C)	Contr Price
KB-102	1" x 1/2" x 3/4"	\$49.70
KB-104	1" x 3/4" x 1/2"	\$49.70
KB-151	1-1/2" x 1" x 7/8"	\$51.70
KB-154	1-1/2" x 3/4" x 1"	\$51.70
KB-201	2" x 1" x 1-3/8"	\$53.20
KB-204	2" x 3/4" x 1-1/2"	\$53.20

Square Groove

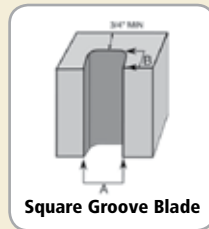

Square Groove Blade

Square Groove Tool, Blades and Sled Kits

Part Code	Dimensions (A and B)	Contr Price
KS-101	1" x 1"	\$49.70
KS-102	1" x 1/2"	\$48.70
KS-103	1" x 3/4"	\$48.70
KS-151	1-1/2" x 1"	\$51.70
KS-152	1-1/2" x 1/2"	\$51.70
KS-153	1-1/2" x 3/4"	\$51.70
KS-201	2" x 1"	\$53.20
KS-203	2" x 3/4"	\$53.20
KS-502	1/2" x 1/2"	\$43.70
KS-752	3/4" x 1/2"	\$45.20
KS-753	3/4" x 3/4"	\$46.20



Buy the Kit and Save!

REPLACEMENT BLADES, SLEDS AND HANDLES



Groove Tool Handle

Part Code	Description	Contr Price	Approx Wt
GT-HANDLE	SS Wood	\$14.70	1 lb
GT-HANDLECS	SS Comfort-Soft	\$15.70	1 lb

*Custom Blades Available
See order form at www.wind-lock.com*



V Groove Hot Knife Blades ONLY

Part Code	Dimensions (A and B)	Contr Price
HV-100	1" x 1/2"	\$15.50
HV-101	1" x 1"	\$16.50
HV-150	1-1/2" x 3/4"	\$17.00
HV-175	1" x 3/4"	\$16.50
HV-200	2" x 1"	\$18.00
HV-5050	1/2" x 1/2"	\$14.50
HV-75	3/4" x 3/8"	\$14.50
HV-7575	3/4" x 3/4"	\$15.50



V Groove Nylon Sleds

Part Code	Dimensions (A and B)	Contr Price
GSV-100	1" x 1/2"	\$12.00
GSV-101	1" x 1"	\$13.00
GSV-150	1-1/2" x 3/4"	\$14.00
GSV-175	1" x 3/4"	\$12.50
GSV-200	2" x 1"	\$16.00
GSV-5050	1/2" x 1/2"	\$11.00
GSV-75	3/4" x 3/8"	\$11.00
GSV-7575	3/4" x 3/4"	\$11.50



Angled Groove Hot Knife Blades ONLY

Part Code	Dimensions (A, B and C)	Contr Price
HA-102	1" x 1/2" x 1/2"	\$15.50
HA-104	1" x 3/4" x 1/4"	\$17.00
HA-152	1-1/2" x 1/2" x 1"	\$17.00
HA-154	1-1/2" x 3/4" x 3/4"	\$18.00
HA-201	2" x 1" x 1"	\$18.00
HA-202	2" x 1/2" x 1-1/2"	\$18.00
HA-204	2" x 3/4" x 1-1/4"	\$18.00
HA-301	3" x 1" x 2"	\$22.50



Angled Groove Nylon Sleds

Part Code	Dimensions (A, B and C)	Contr Price
GSA-102	1" x 1/2" x 1/2"	\$12.00
GSA-104	1" x 3/4" x 1/4"	\$12.00
GSA-152	1-1/2" x 1/2" x 1"	\$13.00
GSA-154	1-1/2" x 3/4" x 3/4"	\$13.00
GSA-201	2" x 1" x 1"	\$14.00
GSA-202	2" x 1/2" x 1-1/2"	\$14.00
GSA-204	2" x 3/4" x 1-1/4"	\$14.00
GSA-301	3" x 1" x 2"	\$17.00



Beveled Groove Hot Knife Blades ONLY

Part Code	Dimensions (A, B and C)	Contr Price
HB-102	1" x 1/2" x 3/4"	\$15.50
HB-104	1" x 3/4" x 1/2"	\$15.50
HB-151	1-1/2" x 1" x 7/8"	\$17.00
HB-154	1-1/2" x 3/4" x 1"	\$17.00
HB-201	2" x 1" x 1-3/8"	\$18.00
HB-204	2" x 3/4" x 1-1/2"	\$18.00



Beveled Groove Nylon Sled Set

Part Code	Dimensions (A, B and C)	Contr Price
GSB-102	1" x 1/2" x 3/4"	\$25.00
GSB-104	1" x 3/4" x 1/2"	\$25.00
GSB-151	1-1/2" x 1" x 7/8"	\$26.00
GSB-154	1-1/2" x 3/4" x 1"	\$26.00
GSB-201	2" x 1" x 1-3/8"	\$27.00
GSB-204	2" x 3/4" x 1-1/2"	\$27.00

Includes 2 Nylon Sleds, base and finish coats.



Square Groove Hot Knife Blades ONLY

Part Code	Dimensions (A and B)	Contr Price
HS-101	1" x 1"	\$16.00
HS-102	1" x 1/2"	\$16.00
HS-103	1" x 3/4"	\$16.00
HS-151	1-1/2" x 1"	\$17.00
HS-152	1-1/2" x 1/2"	\$17.00
HS-153	1-1/2" x 3/4"	\$17.00
HS-201	2" x 1"	\$18.00
HS-203	2" x 3/4"	\$18.00
HS-502	1/2" x 1/2"	\$14.00
HS-752	3/4" x 1/2"	\$14.50
HS-753	3/4" x 3/4"	\$14.50



Square Groove Nylon Sled Set

Part Code	Dimensions (A and B)	Contr Price
GSS-101	1" x 1"	\$25.00
GSS-102	1" x 1/2"	\$24.00
GSS-103	1" x 3/4"	\$24.00
GSS-151	1-1/2" x 1"	\$26.00
GSS-152	1-1/2" x 1/2"	\$25.00
GSS-153	1-1/2" x 3/4"	\$26.00
GSS-201	2" x 1"	\$24.00
GSS-203	2" x 3/4"	\$27.00
GSS-502	1/2" x 1/2"	\$20.00
GSS-752	3/4" x 1/2"	\$22.00
GSS-753	3/4" x 3/4"	\$23.00

Includes 2 Nylon Sleds, base and finish coats.



FOAM2FOAM® GUN FOAMS

EIFS Contractors' Preferred Gap Filler.



Cleans up hands and tools. See page 32.



Buy the Kit and Save!

A multi-purpose, professional, low-expansion construction adhesive and gap and crack filler. Great for ICF, SIP, EIFS and stone veneer applications. One component polyurethane foam. Cures by absorbing water vapor from the air.

- Used for filling, slivering, sealing and insulating joints and cracks
- Professional quality
- Accurately controlled application
- Moisture-curing
- Acoustical sealant
- Drywall adhesive: reduces fasteners by 60%
- Excellent adhesion to most surfaces
- Temperature, water and chemical resistant
- No CFC/HCFC
- Stone veneer adhesive
- Compatible with EPS foam boards
- Paintable and can be plastered over

Consult your system manufacturer for specific recommendations.

1. W-F2F® Foam and Cleaner

Part Code	Description	Contr Price	Approx Wt
W-F2F24	Wind-lock Foam2Foam Case	CALL	22 lb
W-PGCS	F2F® Gun Cleaner 12 oz Case	CALL	13 lb

2. F2F® Sliver Kit NEW!

KIT INCLUDES: 3 Cans F2F®, 1 Can F2F® Cleaner, 1 W-EG13T Foam Gun, 1 Pair Protective Rubber Coated Gloves.

Part Code	Description	Contr Price	Approx Wt
W-ESK	Wind-lock F2F Kit	CALL	6 lb

3. Contractor's Choice Value Kit NEW!

KIT INCLUDES: 11 Cans of F2F®, 1 Can of F2F® Cleaner, 1 W-EG13T Foam Gun, 1 Pair Protective Rubber Coated Gloves.

Part Code	Description	Contr Price	Approx Wt
W-CCV11	Contractors' Choice Foam Kit	CALL	22 lb

4. 11/1 Foam Convenience Kit

KIT INCLUDES: 1 Can of F2F® Cleaner, 11 Cans of F2F®

Part Code	Description	Contr Price	Approx Wt
W-CLF2F	11/1 Foam Convenience Kit	CALL	22 lb



Stock to Dock Shipping Guarantee

Products highlighted in yellow are guaranteed to ship within 24 hours or freight costs are **FREE!** Larger orders may require additional lead times. Call for details.

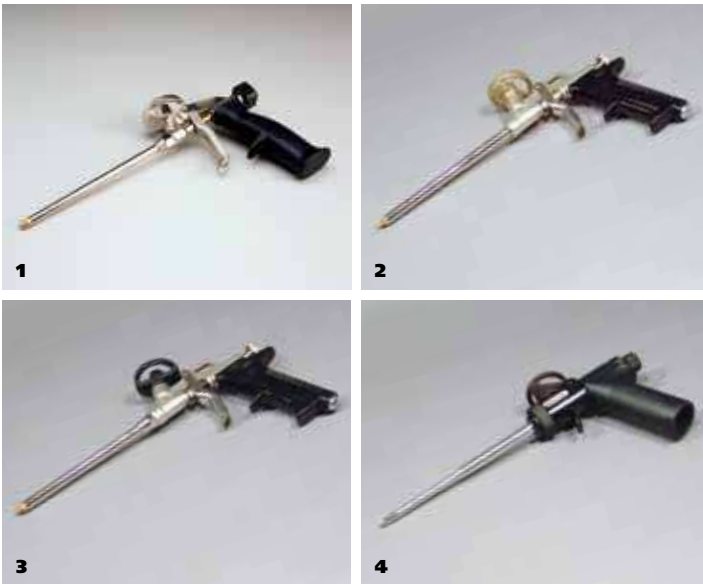

FOAM GUNS

All of our guns are engineered to deliver foam day after day with minimal cleaning. The all-metal needle valve construction delivers the polyurethane foam with controlled accuracy. We offer a wide variety, ranging from “do it yourself” models to professional.

ECONOMY SERIES

1. W-EG13T Taper Tip Foam Dispenser

Light-medium duty gun, featuring all-metal needle valve construction and brass tapered tip with universal can adapter and tip. This is our best gun for filling in EPS board gaps.

Part Code	Description	Contr Price	Approx Wt
W-EG13T	Taper Tip Foam Dispenser	\$35.95	2 lb

2. W-EG13

Light-medium duty gun, featuring all-metal needle valve construction and brass universal can adapter and tip.

Part Code	Description	Contr Price	Approx Wt
W-EG13	Economy Foam Dispenser	\$39.95	2 lb

INTERMEDIATE SERIES

3. W-EG14

Medium duty gun featuring a Teflon® coated needle valve and universal can adapter. The knurled brass dispensing tip is the knurled brass that holds the extension tubes in place. Also available with a 31" long extended barrel for long reach or sub floor applications.

Part Code	Description	Contr Price	Approx Wt
W-EG14	Foam Dispenser with Teflon Tip	\$56.50	2 lb
NS W-EG14L	31" Long-Barrel	\$139.75	4 lb
NS W-EG14BT	Brass tips for W-EG14	\$3.75	1 lb

NS=Not shown.

PROFESSIONAL SERIES

4. W-EG15

This professional gun features a narrow tapered tip for dispensing the foam between EIFS board lines. The two stage tapered barrel blends the foam to a superior consistency.

Part Code	Description	Contr Price	Approx Wt
W-EG15	Pageris Foam Dispenser	\$82.35	2 lb

PROPER ATTACHMENT OF FOAM GUNS



1. Attach the gun to the can of F2F®.

4. Removing the can from gun, point can upright and away from your face.



2. The can should point up and away from your face.

5. Clean the gun adapter with the F2F® Cleaner.



3. Shake can for 1 minute and purge air from gun.

6. Attach and spray the cleaner through the gun.

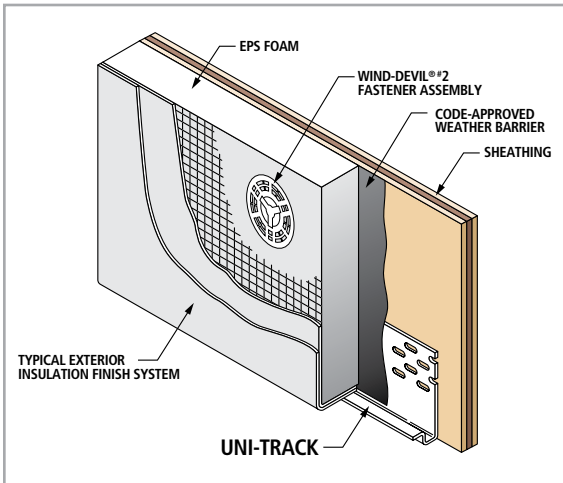

WATER MANAGEMENT

EXCLUSIVE PRODUCT

1. Universal Starter Track

Uni-Track Universal Starter Track is engineered to allow incidental moisture to escape.

- One size fits all
- Reduce inventory
- Eliminates wavy edges
- High impact and rust-proof
- Weep holes 5" on center
- 40 pieces per box

Part Code	Qty/Box	Description	Contr Price/Pc	Approx Wt/Box
W-UST	40	8' Universal Starter Track	\$9.50	44 lb
W-UST10	40	10' Universal Starter Track	\$11.50	65 lb

Now available in 10' sections.

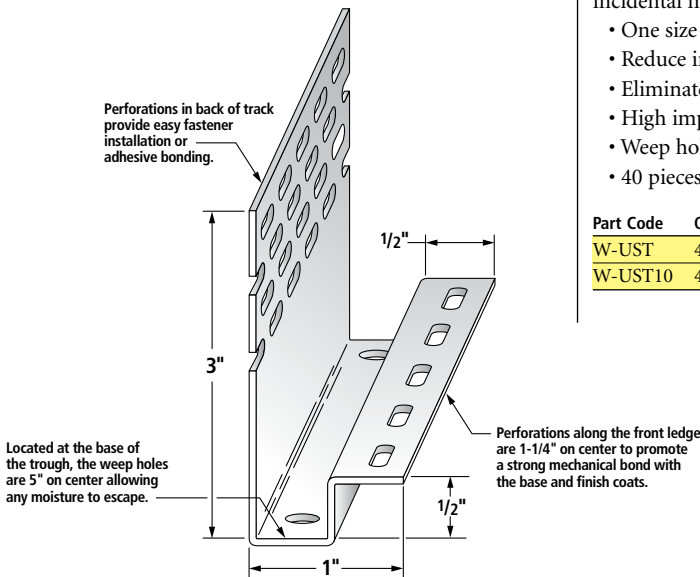

Stock to Dock Shipping Guarantee

Products highlighted in yellow are guaranteed to ship within 24 hours or freight costs are **FREE!** Larger orders may require additional lead times. Call for details.

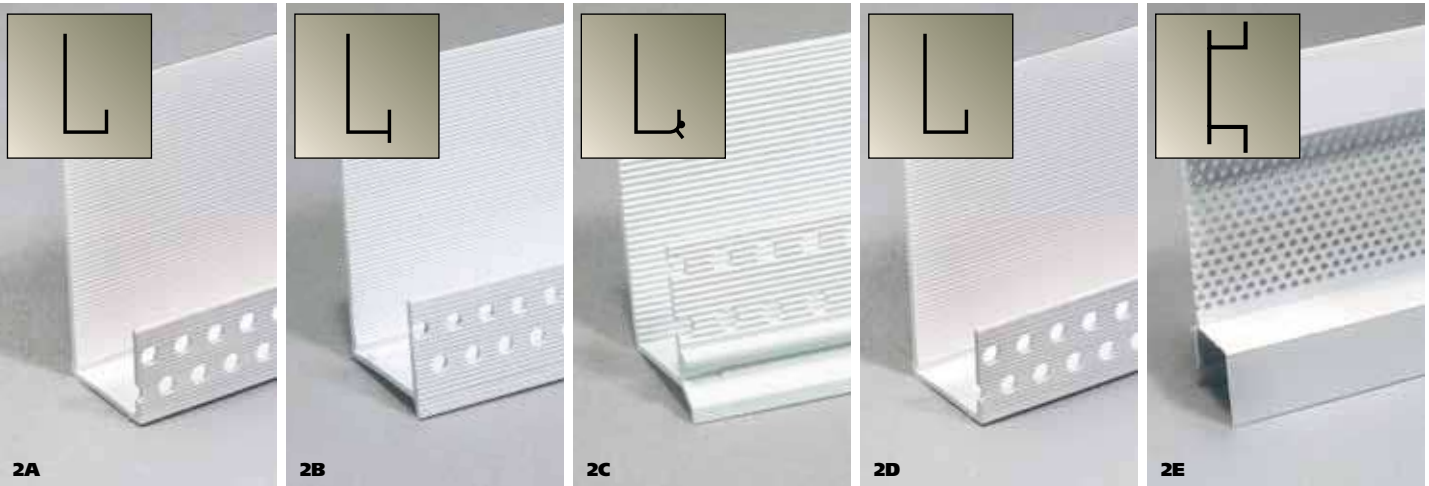

PLASTIC PC
COMPONENTS *inc.*

2. Insulation Starter Tracs

Plastic Components Starter Tracs are designed for use with today's building systems. These Starter Tracs are available by the piece or in full box quantities, and can be shipped UPS/FedEx direct to the job site.

8' Sections

Part Code	Qty/Box	Size	Description	Approx Wt/Box
A WST-1	25	1" x 8'	Casing Bead	53 lb
A WST-15	20	1-1/2" x 8'	Casing Bead	47 lb
A WST-2	15	2" x 8'	Casing Bead	39 lb
A WST-25	15	2-1/2" x 8'	Casing Bead	20 lb
A WST-3	10	3" x 8'	Casing Bead	20 lb
B WSTDE-1	25	1" x 8'	Drip Edge Weep Holes	48 lb
B WSTDE-15	20	1-1/2" x 8'	Drip Edge Weep Holes	43 lb
B WSTDE-2	15	2" x 8'	Drip Edge Weep Holes	36 lb
B WSTDE-25	15	2-1/2" x 8'	Drip Edge Weep Holes	20 lb
B WSTDE-3	10	3" x 8'	Drip Edge Weep Holes	20 lb
B WSTDE-75	30	3/4" x 8'	Drip Edge Weep Holes	47 lb
C WDST-1	25	1" x 8'	Window/Door	43 lb
C WDST-15	20	1-1/2" x 8'	Window/Door	37 lb
C WDST-2	15	2" x 8'	Window/Door	31 lb
D WST8-1WP	25	1" x 8'	Casing Bead Weep Holes	52 lb
D WST8-15WP	20	1-1/2" x 8'	Casing Bead Weep Holes	49 lb
D WST8-2WP	15	2" x 8'	Casing Bead Weep Holes	35 lb
D WST8-75WP	30	3/4" x 8'	Casing Bead Weep Holes	48 lb
E WSV548-1	10	1" x 8'	Continuous Soffit Vent	20 lb
E WSV548-15	8	1-1/2" x 8'	Continuous Soffit Vent	20 lb

Call for pricing.

10' Sections

Part Code	Qty/Box	Size	Description	Approx Wt/Box
A WST10-1	25	1" x 10'	Casing Bead	67 lb
A WST10-15	20	1-1/2" x 10'	Casing Bead	59 lb
A WST10-2	15	2" x 10'	Casing Bead	49 lb
A WST10-25	15	2-1/2" x 10'	Casing Bead	51 lb
A WST10-4	10	4" x 10'	Casing Bead	51 lb
B WSTDE10-1	25	1" x 10'	Drip Edge Weep Holes	60 lb
B WSTDE10-15	20	1-1/2" x 10'	Drip Edge Weep Holes	51 lb
B WSTDE10-2	15	2" x 10'	Drip Edge Weep Holes	48 lb
B WSTDE10-3	10	3" x 10'	Drip Edge Weep Holes	20 lb
B WSTDE10-4	10	4" x 10'	Drip Edge Weep Holes	24 lb
D WSTDE10-75	30	3/4" x 10'	Drip Edge Weep Holes	46 lb
D WSTWP-50	35	1/2" x 10'	Casing Bead Weep Holes	68 lb
D WST-75WP	30	3/4" x 10'	Casing Bead Weep Holes	44 lb
D WST-78WP	30	7/8" x 10'	Casing Bead Weep Holes	45 lb
D WST-1WP	25	1" x 10'	Casing Bead Weep Holes	53 lb
D WST-15WP	20	1-1/2" x 10'	Casing Bead Weep Holes	48 lb
D WST-2WP	15	2" x 10'	Casing Bead Weep Holes	46 lb
D WST10-25WP	15	2-1/2" x 10'	Casing Bead Weep Holes	46 lb
D WST10-3WP	10	3" x 10'	Casing Bead Weep Holes	20 lb
D WST10-4WP	10	4" x 10'	Casing Bead Weep Holes	21 lb

Call for pricing.

For additional stucco and plaster trims, see page 51.



SEE PAGE 13 FOR HAMMER TACKERS AND STAPLES



NEW!

Stock to Dock Shipping Guarantee
 Products highlighted in yellow are guaranteed to ship within 24 hours or freight costs are FREE! Larger orders may require additional lead times. Call for details.

SECONDARY MOISTURE BARRIER WRAP

3. Weather Trek EVD House Wrap

Weather Trek EVD house wrap is the perfect house wrap for EIFS and stucco construction.

Part Code	Qty/Skid	Size	Contr Price/Pc	Approx Wt/Box
W-WTK	36	5' x 200'	CALL	144 lb

4. Tyvek® StuccoWrap™ and Sheathing Tape

Tyvek® StuccoWrap™ from DuPont® is designed and engineered for comfort, energy efficiency and protection from water and moisture damage.

Part Code	Qty/Box	Size	Description	Contr Price/Pc	Approx Wt/Box
W-TST	36	2" x 55 yd	Sheathing Tape	CALL	18 lb
W-TSW5	9	5' x 200'	StuccoWrap	CALL	144 lb

5. Dow® Weathermate™ Housewrap—Plus

Weathermate™ Housewrap—Plus is a non-woven, non-perforated, polyolefin-based housewrap that offers exceptional tear resistance and durability. It is an effective option for builders who prefer to use non-insulating sheathing along with housewrap. When installed over sheathing, Weathermate™ Housewrap—Plus reduces costly air and moisture infiltration. It is translucent to allow a clear view of the studs and the sheathing surface during installation.

Part Code	Qty/Skid	Size	Description	Contr Price	Approx Wt
W-DWM3165	22	3' x 165'	Housewrap Plus	CALL	14 lbs
W-DWM5100	38	5' x 100'	Housewrap Plus	CALL	14 lbs
W-DWM9100	38	9' x 100'	Housewrap Plus	CALL	24 lbs
W-DWM9150	33	9' x 150'	Housewrap Plus	CALL	34 lbs

All other DOW® Weathermate™—Plus sizes are available. Please call.
 Note: Also see Weatherization Section, page 78.

6. Benjamin Obdyke Home Slicker® NEW!

Home Slicker® Stone & Stucco is the only vertically channeled rainscreen that has been specifically designed for use with manufactured stone, natural stone, stucco and masonry applications. Each roll contains the patented Home Slicker® three-dimensional matrix bonded to a fabric which prevents mortar from entering the wall cavity during cladding installation. This product installs with the fabric facing outward.

Home Slicker® Plus Typar® is a cost-effective, labor and material saving, moisture eliminating rainscreen combined with a water resistive barrier. Each roll contains the patented Home Slicker® three-dimensional matrix bonded to Typar®, the premium residential and commercial grade housewrap. The unique, vertically-channeled, three-dimensional matrix of the original Home Slicker® provides a continuous space for drainage and drying, a thermal break and pressure equalization—eliminating the threat of trapped moisture. Home Slicker® 10 is designed to meet the 10mm code requirements in Canada.

Part Code	Qty/Skid	Size	Description	Contr Price	Approx Wt
NS W-HSST	16	39"x61.5' 200 sq ft	Stone & Stucco Rainscreen 6 mil	\$137.45	16 lbs
NS W-HS10ST	16	39"x38.5' 125 sq ft	Stone & Stucco Rainscreen 10 mil	\$113.25	25 lbs
W-HSPT	16	39"x61.5' 200 sq ft	Plus Typar Rainscreen 6 mil	\$137.45	15 lbs
NS W-HS10PT	16	39"x38.5' 125 sq ft	Plus Typar Rainscreen 10 mil	\$113.25	15 lbs
NS W-HS	16	39"x46.5' 150 sq ft	Rainscreen 6 mil	\$88.05	10 lbs
NS W-HS10N	16	39"x38.5' 125 sq ft	Rainscreen 10 mil	\$86.30	8 lbs

NS=Not shown.

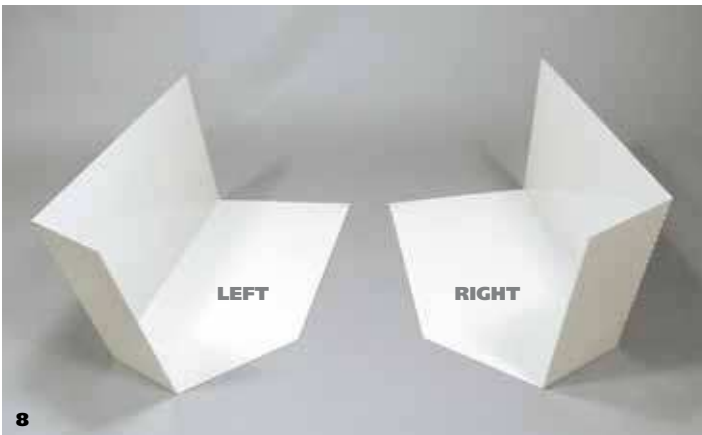
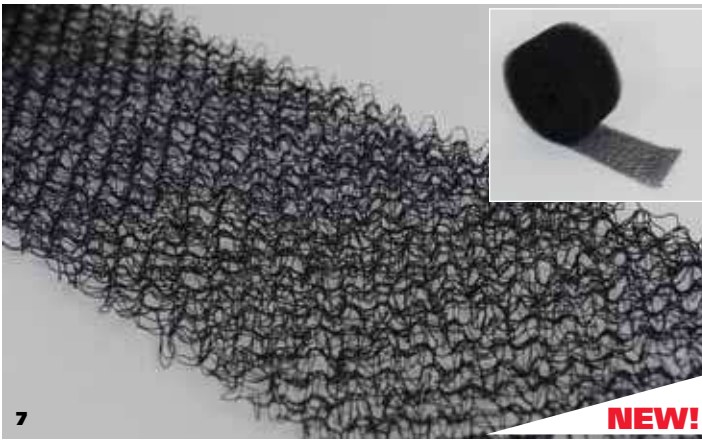

7. Benjamin Obdyke Blockade™ NEW!

Designed specifically for use in brick wall cavities, the entangled matrix design of the Blockade™ Mortar Deflection System blocks mortar from clogging the weep holes and allows excess moisture to flow freely out of the wall cavity. The result is a brick wall that is built to stand the test of time and remains free from the deteriorating effects of mold and mildew.

Part Code	Qty/Skid	Size	Description	Contr Price	Approx Wt
W-BA80	16	50'x 10"x .80"	80 Mortar Deflection .80" thick	\$33.50	5 lb
W-BA150	16	50'x 10"x 1.5"	80 Mortar Deflection 1.5" thick	\$56.35	4 lb

8. Aluminum Kickout Flashing

Part Code	Size	Description	Contr Price	Approx Wt
W-KODL	10" x 6"	Kickout Diverter LH Alum	\$15.30	1 lb
W-KODR	10" x 6"	Kickout Diverter RH Alum	\$15.30	1 lb

Aluminum Kickout Flashing

Powder Coated.

Part Code	Size	Description	Contr Price	Approx Wt
W-KODLB	10" x 6"	Beige Kickout Diverter LH Alum	\$18.95	1 lb
W-KODRB	10" x 6"	Beige Kickout Diverter RH Alum	\$18.95	1 lb
W-KODLG	10" x 6"	Gray Kickout Diverter LH Alum	\$18.95	1 lb
W-KODRG	10" x 6"	Gray Kickout Diverter RH Alum	\$18.95	1 lb
W-KODLW	10" x 6"	White Kickout Diverter LH Alum	\$18.95	1 lb
W-KODRW	10" x 6"	White Kickout Diverter RH Alum	\$18.95	1 lb

9. DryFlekt® Polypropylene Kickout Flashing

The best practice solution for diverting roofline water. The patented design creates a downward and outward water flow off the roof and away from walls, preventing water intrusion at roof-to-wall intersections. DryFlekt® is manufactured in left and right parts, available in six aesthetically pleasing colors: brown, bronze, sand, tan, gray and white.

Part Code	Size	Description	Contr Price	Approx Wt
A W-PKOLB	14" x 6"	Brown Kickout Diverter LH Polypro	\$10.95	1 lb
A W-PKORB	14" x 6"	Brown Kickout Diverter RH Polypro	\$10.95	1 lb
B W-PKORBZ	14" x 6"	Bronze Kickout Diverter RH Polypro	\$10.95	1 lb
B W-PKOLBZ	14" x 6"	Bronze Kickout Diverter LH Polypro	\$10.95	1 lb
C W-PKORS	14" x 6"	Sand Kickout Diverter RH Polypro	\$10.95	1 lb
C W-PKOLS	14" x 6"	Sand Kickout Diverter LH Polypro	\$10.95	1 lb
D W-PKOLT	14" x 6"	Tan Kickout Diverter LH Polypro	\$10.95	1 lb
D W-PKORT	14" x 6"	Tan Kickout Diverter RH Polypro	\$10.95	1 lb
E W-PKOLG	14" x 6"	Gray Kickout Diverter LH Polypro	\$10.95	1 lb
E W-PKORG	14" x 6"	Gray Kickout Diverter RH Polypro	\$10.95	1 lb
F W-PKOLW	14" x 6"	White Kickout Diverter LH Polypro	\$10.95	1 lb
F W-PKORW	14" x 6"	White Kickout Diverter RH Polypro	\$10.95	1 lb



10



11



13



12A



12B



12



14



15

10. Window/Door Membrane Flashing

A secondary weather barrier for use around windows, doors or any structural opening. Primer is recommended.

Part Code	Qty/Box	Size	Description	Contr Price/Pc	Approx Wt/Box
W-PWDT4	12	4" x 100' x 30 mil	Flashing Tape	\$32.50	99 lb
W-PWDT6	8	6" x 100' x 30 mil	Flashing Tape	\$50.65	96 lb
W-PWDT9	4	9" x 100' x 30 mil	Flashing Tape	\$77.95	80 lb
W-PWDT12	4	12" x 100' x 30 mil	Flashing Tape	\$100.95	98 lb

11. Caulking Spatulas

Part Code	Size	Description	Contr Price	Approx Wt/Box
W-DS3	3" x 5/8"	Spatula	\$13.25	1 lb
W-DS4	4" x 5/8"	Spatula	\$14.35	1 lb
W-DS6	6" x 1"	Spatula	\$15.50	1 lb
W-DSKIT	All Sizes	Detail Spatula Kit	\$41.05	1 lb

12. Backer Rod

Part Code	Size	Description	Contr Price/Pc	Approx Wt/Box
A W-SR38	3/8" x 1800'	Sof-Rod™	\$116.30	5 lb
A W-SR58	5/8" x 1550'	Sof-Rod™	\$133.45	12 lb
A W-SR78	7/8" x 850'	Sof-Rod™	\$126.15	12 lb
A W-SR112	1-1/2" x 552'	Sof-Rod™	\$227.25	23 lb
A W-SR38H	3/8" x 1400'	Sof-Rod™ Handi Pack	\$106.20	5 lb
A W-SR58H	5/8" x 550'	Sof-Rod™ Handi Pack	\$56.45	5 lb
A W-SR78H	7/8" x 330'	Sof-Rod™ Handi Pack	\$62.35	5 lb
B W-SR48	1/2" x 2500'	Hard Rod	\$160.95	11 lb
B W-SR48H	1/2" x 800'	Hard Rod Handi Pack	\$67.95	4 lb
B W-HR34H	3/4" x 400'	Hard Rod Handi Pack	\$69.75	4 lb
B W-HR38H	3/8" x 1400'	Hard Rod Handi Pack	\$89.90	4 lb
B W-HR58H	5/8" x 550'	Hard Rod Handi Pack	\$68.85	4 lb

13. Water Based Primer

Recommended to be used with flashings, wraps and liners. To obtain manufacturer's recommended coverage per gallon, call 1-800-872-5625.

Part Code	Qty/Box	Size	Description	Contr Price	Approx Wt/Box
W-STP	4	1 gallon	Mfg Water Based Primer Trans Wrap	\$63.75	9 lb

14. Dow® Contractors Weatherproofing Sealant

Part Code	Qty/Box	Description	Contr Price/Box	Approx Wt/Box
W-DRAW	(12) 10 oz Tubes	Dow CWS/Antique White	\$69.95	14 lb
W-DRBK	(12) 10 oz Tubes	Dow CWS/Black	\$69.95	14 lb
W-DRBZ	(12) 10 oz Tubes	Dow CWS/Bronze	\$69.95	14 lb
W-DRGR	(12) 10 oz Tubes	Dow CWS/Gray	\$69.95	14 lb
W-DRLS	(12) 10 oz Tubes	Dow CWS/Limestone	\$69.95	14 lb
W-DRSS	(12) 10 oz Tubes	Dow CWS/Sandstone	\$69.95	14 lb
W-DRTW	(12) 10 oz Tubes	Dow CWS/True White	\$69.95	14 lb

Pecora Sealant also available. Call for details.

Consult physical sample before choosing. To obtain a full coverage chart, free color samples and/or custom color details, call 1-800-872-5625.

15. Dow® Corning 790 Silicone Building Sealant

Part Code	Qty/Box	Description	Contr Price/Box	Approx Wt/Box
W-DCAT	(12) 10 oz Tubes	Dow 790 Adobe Tan	\$100.50	14 lb
W-DCBK	(12) 10 oz Tubes	Dow 790 Black	\$100.50	14 lb
W-DCGR	(12) 10 oz Tubes	Dow 790 Gray	\$100.50	14 lb
W-DCNS	(12) 10 oz Tubes	Dow 790 Natural Stone	\$100.50	14 lb
W-DCPC	(12) 10 oz Tubes	Dow 790 Precast White	\$100.50	14 lb

Consult physical sample before choosing. To obtain a full coverage chart, free color samples and/or custom color details, call 1-800-872-5625.

For all Weatherization and Flashing Items, go to page 83.



RASPS AND ACCESSORIES

1. UGZ® II EverRasp

Engineered better. EPS doesn't stand a chance!

- Copper electro-plated tungsten grit
- Uniform even grit
- Permanent: lasts up to 100 times longer than paper
- Rounded corners for gouge free rasping

Part Code	Size	Description	Contr Price	Approx Wt
I-IIUGZ2	2" x 14"	SS Rasp 12-14 Grit	\$44.75	2 lb
I-IIUGZ4	4" x 14"	SS Rasp 12-14 Grit	\$64.75	2 lb
I-IIUGZ6	6" x 14"	SS Rasp 12-14 Grit	\$74.75	3 lb
I-IIUGZ8	8" x 14"	SS Rasp 12-14 Grit	\$84.75	3 lb
I-IIUGZK26	2" and 6" x 14"	SS Rasp Kit	\$119.75	5 lb
I-IITUGZ46	4" and 6" x 14"	Toothed SS Rasp	\$144.75	5 lb

2. UGZ® II TOOTH EverRasp

Engineered better. EPS doesn't stand a chance! Same great UGZ®, but now with a toothed edge for shaving and trimming EPS.

Part Code	Size	Description	Contr Price	Approx Wt
I-IITUGZ4	4" x 14"	Toothed SS Rasp 12-14 Grit	\$68.75	2 lb
I-IITUGZ6	6" x 14"	Toothed SS Rasp 12-14 Grit	\$78.75	3 lb
I-IITUGZ8	8" x 14"	Toothed SS Rasp 12-14 Grit	\$88.75	3 lb
I-IITUGZ46	4" and 6" x 14"	Toothed SS Rasp	\$144.75	5 lb



3



4



5



6

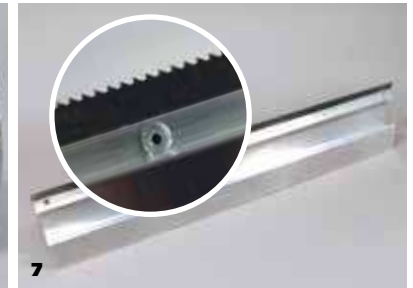

7



8

3. Plastic Hand Rasps

Part Code	Size	Description	Contr Price	Approx Wt
I-PSR4	4" x 14"	Plastic Sanding Rasp	\$18.80	1 lb
I-PSR6	6" x 14"	Plastic Sanding Rasp	\$23.05	1 lb

4. Aluminum Hand Rasps

Part Code	Size	Description	Contr Price	Approx Wt
I-SR2	2" x 14"	Sanding Rasp	\$14.50	1 lb
I-SR4	4" x 14"	Sanding Rasp	\$21.70	2 lb
I-SR6	6" x 14"	Sanding Rasp	\$26.95	2 lb
I-SR8	8" x 16"	Sanding Rasp	\$44.25	3 lb

5. Pneumatic Hand Rasp

Part Code	Size	Description	Contr Price	Approx Wt
I-PAR	8" x 18"	Pneumatic Rasp	\$466.85	8 lb

6. Adhesive Rasp Paper Rolls

Part Code	Size	Description	Contr Price	Approx Wt
I-AROLL2	2" x 25 yd	Roll 16 Grit	CALL	6 lb
I-AROLL4	4" x 25 yd	Roll 16 Grit	CALL	11 lb
I-AROLL6	6" x 25 yd	Roll 16 Grit	CALL	15 lb
I-AROLL8	8" x 25 yd	Roll 16 Grit	CALL	20 lb
12-AROLL2	2" x 25 yd	Roll 12 Grit	CALL	5 lb
12-AROLL4	4" x 25 yd	Roll 12 Grit	CALL	10 lb
12-AROLL6	6" x 25 yd	Roll 12 Grit	CALL	18 lb
12-AROLL8	8" x 25 yd	Roll 12 Grit	CALL	19 lb

Non-Adhesive Rasp Paper Rolls

Part Code	Size	Description	Contr Price	Approx Wt
I-ROLL2	2" x 50 yd	Roll 16 Grit	CALL	7 lb
I-ROLL4	4" x 50 yd	Roll 16 Grit	CALL	21 lb
I-ROLL6	6" x 50 yd	Roll 16 Grit	CALL	28 lb
I-ROLL8	8" x 50 yd	Roll 16 Grit	CALL	30 lb
12-IROLL2	2" x 50 yd	Roll 12 Grit	CALL	12 lb
12-IROLL4	4" x 50 yd	Roll 12 Grit	CALL	23 lb
12-IROLL6	6" x 50 yd	Roll 12 Grit	CALL	34 lb
12-IROLL8	8" x 50 yd	Roll 12 Grit	CALL	40 lb

7. Knockdown Rasp

Serrated edge to level large walls in seconds.

Part Code	Size	Description	Contr Price	Approx Wt
HDS-2	2'	Speed Rasp Aluminum	\$69.95	2 lb
HDS-4	4'	Speed Rasp Aluminum	\$117.95	3 lb
HDS-6	6'	Speed Rasp Aluminum	\$167.95	4 lb

8. Adhesive Paper Sheets 12 Pack

Part Code	Size	Description	Contr Price	Approx Wt
I-RPA2	2" x 14"	16 Grit Sheets	CALL	1 lb
I-RPA4	4" x 14"	16 Grit Sheets	CALL	2 lb
I-RPA6	6" x 14"	16 Grit Sheets	CALL	3 lb
I-RPA86	8" x 16"	16 Grit Sheets	CALL	4 lb
I-RPA88	8" x 18"	16 Grit Sheets	CALL	5 lb
12-IRPA2	2" x 14"	12 Grit Sheets	CALL	1 lb
12-IRPA4	4" x 14"	12 Grit Sheets	CALL	2 lb
12-IRPA6	6" x 14"	12 Grit Sheets	CALL	3 lb
12-IRPA86	8" x 16"	12 Grit Sheets	CALL	4 lb
12-IRPA88	8" x 18"	12 Grit Sheets	CALL	5 lb



9



9



11



10



10



12

9. DuraRasp™

Steel tungsten carbide rasp. Heavy brazed #12 tungsten grit.

Part Code	Size	Description	Contr Price	Approx Wt
T-DR2	2" x 14"	DuraRasp Steel	\$45.00	2 lb
T-DR4	4" x 14"	DuraRasp Steel	\$65.00	2 lb
T-DR6	6" x 14"	DuraRasp Steel	\$75.00	3 lb
T-DR8	8" x 14"	DuraRasp Steel	\$85.00	3 lb
T-DRK26	2" and 6" x 14"	DuraRasp Steel Kit	\$120.00	3 lb
T-DRK46	4" and 6" x 14"	DuraRasp Steel Kit	\$140.00	4 lb

10. Tiger Claw DuraRasp™

- Shaves high spots
- Cut-off saw
- #12 tungsten grit

Part Code	Size	Description	Contr Price	Approx Wt
T-TC4	4" x 14"	Tiger Claw	\$69.00	2 lb
T-TC6	6" x 14"	Tiger Claw	\$79.00	2 lb
T-TC8	8" x 14"	Tiger Claw	\$89.00	3 lb
T-TCK46	4" and 6" x 14"	Tiger Claw Kit	\$145.10	4 lb

**Buy the Kit
and Save!**

11. Bull Nose DuraRasp™

Curved tungsten carbide rasp. Heavy, brazed #12 tungsten grit.

- 5" wide bull nose design
- Soft-grip handle

Part Code	Size	Description	Contr Price	Approx Wt
T-DB514	5" x 14"	Bull Nose DuraRasp	\$80.00	2 lb

12. Double Sided DuraRasp™

2-sided tungsten carbide rasp. Heavy, brazed #12 tungsten grit.

- Easy rasping in hard to reach areas
- Built-in knuckle pad
- Soft-grip handle

Part Code	Size	Description	Contr Price	Approx Wt
T-DE614	6" x 14"	Double Sided DuraRasp	\$90.00	2 lb

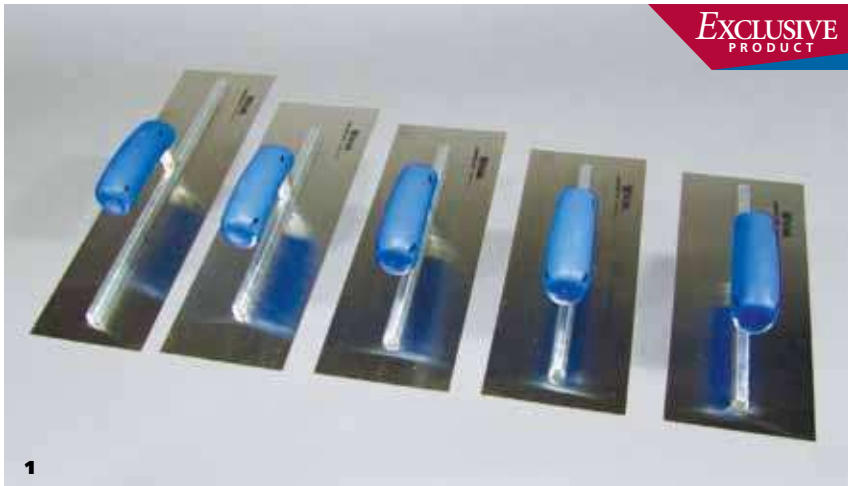

1



2



3



4

WIND-LOCK® COMFORT-SOFT™ HANDLE TROWELS



Finest Hand Crafted Trowels Available.

A combination of hard plastic core and soft plastic cover for optimum grip between hand and handles. Reduces handgrip tension and relieves strain in the palm, muscles and tendons.

1. Stainless Steel Plastering Trowels

Part Code	Size	Description	Contr Price	Approx Wt
T-115CS	11-1/2" x 4-3/4"	SS Comfort-Soft	\$30.50	2 lb
T-12CS	12" x 4-3/4"	SS Comfort-Soft	\$31.35	2 lb
T-13CS	13" x 4-3/4"	SS Comfort-Soft	\$32.75	2 lb
T-14CS	14" x 4-3/4"	SS Comfort-Soft	\$35.45	2 lb
T-16CS	16" x 4-3/4"	SS Comfort-Soft	\$39.25	2 lb

2. Stainless Steel Venetian Trowels

Round, polished edge for precise craftsmanship.

Part Code	Size	Description	Contr Price	Approx Wt
T-VT2008	7-3/4" x 3-1/8"	SS Comfort-Soft	\$33.95	2 lb
T-VT24011	9-1/2" x 4-1/4"	SS Comfort-Soft	\$36.70	2 lb
T-VT28012	11" x 4-3/4"	SS Comfort-Soft	\$39.45	2 lb

3. Pavan® Trowels

Authentic Italian Pavan® trowels are preferred by artisans worldwide who strive to achieve a superior Venetian finish. Made of INOX stainless steel, Pavan trowels are ideal for preserving the true color of these fine finishes without burning. Its faired lip, ground blade and curved corners ensure perfect application when polishing Venetian stucco.

Part Code	Size	Description	Contr Price	Approx Wt
T-P240CS	9.45" x 3.94" (240 x 80mm)	Pavan SS Trapezoid Finishing Trowel	\$49.95	1 lb
T-P200CS	7.88" x 3.15" (200 x 80mm)	Pavan SS Trapezoid Finishing Trowel	\$46.50	1 lb

4. Stainless Steel Brilliant Venetian Trowels

The smoothest and brightest finish, with a lightweight plastic handle.

Part Code	Size	Description	Contr Price	Approx Wt
T-VPF2008	7-7/8" x 3-1/8"	SS Comfort-Soft	\$27.15	2 lb
T-VPF2411	9-1/2" x 4-3/8"	SS Comfort-Soft	\$27.95	2 lb
T-VPF2812	11" x 4-3/4"	SS Comfort-Soft	\$29.45	2 lb



Stock to Dock Shipping Guarantee

Products highlighted in yellow are guaranteed to ship within 24 hours or freight costs are **FREE!** Larger orders may require additional lead times. Call for details.



5



6



7



8



9



10

5. Stainless Steel Margin Trowels

Part Code	Size	Description	Contr Price	Approx Wt
T-M358CS	1-1/2" x 3-5/8"	SS Comfort-Soft	\$10.25	1 lb
T-M55CS	2" x 5-1/2"	SS Comfort-Soft	\$10.25	1 lb
T-M7CS	1-1/2" x 7"	SS Comfort-Soft	\$10.25	1 lb
T-SSMKITCS	All Sizes	SS Comfort-Soft Kit	\$27.45	2 lb

6. Carbon Steel Margin Trowels

Part Code	Size	Description	Contr Price	Approx Wt
T-M515CS	1-1/2" x 5"	CRS Comfort-Soft	\$12.55	1 lb
T-M52CS	2" x 5"	CRS Comfort-Soft	\$13.55	1 lb
T-M62CS	2" x 6"	CRS Comfort-Soft	\$14.55	1 lb
T-M82CS	2" x 8"	CRS Comfort-Soft	\$17.55	1 lb
T-SMKITCS	All Sizes	CRS Comfort-Soft Kit	\$50.55	2 lb

7. Outside Corner Edgers

Stainless steel.

Part Code	Size	Description	Contr Price	Approx Wt
T-E75CS	3/4"	SS Comfort-Soft	\$11.85	1 lb
T-E1CS	1"	SS Comfort-Soft	\$11.85	1 lb
T-E15CS	1-1/2"	SS Comfort-Soft	\$11.85	1 lb
T-E2CS	2"	SS Comfort-Soft	\$11.85	1 lb
T-EKITCS	All Sizes	SS Comfort-Soft Kit	\$42.45	2 lb

8. Inside Corner Edgers

Stainless steel.

Part Code	Size	Description	Contr Price	Approx Wt
T-EI75CS	3/4"	SS Comfort-Soft	\$11.85	1 lb
T-EI1CS	1"	SS Comfort-Soft	\$11.85	1 lb
T-EI15CS	1-1/2"	SS Comfort-Soft	\$11.85	1 lb
T-EI2CS	2"	SS Comfort-Soft	\$11.85	1 lb
T-EIKITCS	All Sizes	SS Comfort-Soft Kit	\$42.45	2 lb

9. Pointed and Round Detail Trowels

Stainless steel.

Part Code	Size	Description	Contr Price	Approx Wt
T-RDTCS	6-1/2" x 2-3/8"	SS Round Detail Comfort-Soft	\$9.85	1 lb
T-PDTCS	5-1/2" x 3-1/4"	SS Pointed Detail Comfort-Soft	\$9.85	1 lb
T-DTKITCS	All Sizes	SS Comfort-Soft Kit	\$17.75	2 lb

10. Pipe Trowel

Carbon steel.

Part Code	Size	Description	Contr Price	Approx Wt
T-PTCS	11-1/2" x 3-1/2"	CRS Comfort-Soft	\$25.15	1 lb

**Buy the Kit
and Save!**



11



12



13



14



Stock to Dock Shipping Guarantee

Products highlighted in yellow are guaranteed to ship within 24 hours or freight costs are **FREE!** Larger orders may require additional lead times. Call for details.

11. Comfort-Soft™ Applicator Tool Bag Kit NEW!

KIT INCLUDES: canvas tool bag, 13" x 13" Hawk, rubber coated knit gloves, Bucket Dredger, T-PFTAN float, 4" x 14" stainless steel rasp, Boss® Biggie Wipes, 3" scraper knife, margin trowels: 2" x 5-1/2", outside corner edgers: 1" and 2", inside corner edgers: 1" and 2", 11-1/2" x 4-3/4" stainless steel finish trowel.

Part Code	Description	Contr Price	Approx Wt
W-TBK2CS	Tool Bag Kit Comfort-Soft Handles	\$250.95	15 lb
NS W-TBK2	Tool Bag Kit Wood Handles	\$245.95	15 lb

NS=Not shown.

Also see Ultimate EIFS Kit on page 14.



12. Bucket Opener

Part Code	Description	Contr Price	Approx Wt
B-BO2	3 in 1 Aluminum	\$21.50	1 lb

13. Red Stucco Tape — BEST SELLER!

Weather-resistant stucco tape. The red tape is designed to cover all metal, plastic and vinyl surfaces. Larger widths available upon request. Not for use on glass.

Part Code	Qty/Box	Size	Contr Price/Pc	Approx Wt/Box
W-SRT2	24	2" x 60 yd	\$8.95	27 lb
W-SRT4	12	4" x 60 yd	\$18.55	28 lb

14. Boss® Biggies Industrial Wipes

These dual-sided industrial wipes clean paint, adhesives, oil and more from hands, tools and surfaces.

Part Code	Description	Size	Contr Price
W-BW	Dual-sided abrasive wipes 80 wipes per container	8" x 12"	\$25.95

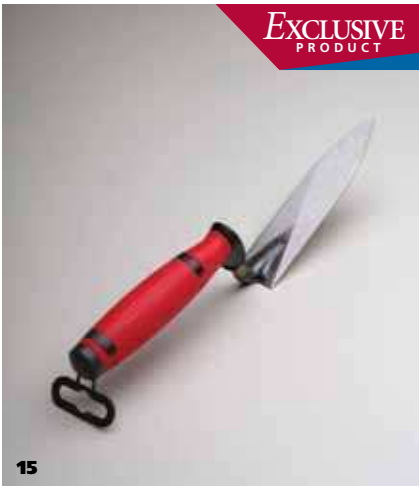

15



16



17



18



19

WIND-LOCK® EZ-GRIP HANDLE TROWELS

Experience all the benefits of regular Comfort-Soft™ Handle Trowels but in a smaller grip with greater finger protection. Made with a combination of hard plastic core and soft plastic cover, the EZ-Grip Trowel reduces hand grip tension and relieves strain in the palm, muscles and tendons.

15. EZ-Grip Pointed Margin Trowel

Carbon steel.

Part Code	Size	Description	Contr Price	Approx Wt
T-MPRCS	1-3/16" x 5"	CS Pointed Margin Trowel	\$12.55	2 lb

16. EZ-Grip Bucket Trowels

Stainless steel.

Part Code	Description	Contr Price	Approx Wt
T-BTSRCS	SS Bucket Trowel	\$16.85	1 lb
T-SBTRCS	SS Small Bucket Trowel	\$15.50	1 lb

17. EZ-Grip Plastering Trowel

Stainless steel.

Part Code	Size	Description	Contr Price	Approx Wt
T-13RCS	5-1/8" x 11"	SS Finishing Trowel	\$32.75	2 lb

18. EZ-Grip Outside Corner Edges Trowels

Stainless steel.

Part Code	Size	Description	Contr Price	Approx Wt
T-E75RCS	3/4"	SS Edger	\$11.85	1 lb
T-E1RCS	1"	SS Edger	\$11.85	1 lb
T-E15RCS	1-1/2"	SS Edger	\$11.85	1 lb
T-E2RCS	2"	SS Edger	\$11.85	1 lb

19. EZ-Grip Inside Corner Edges Trowels

Stainless steel.

Part Code	Size	Description	Contr Price	Approx Wt
T-EI75RCS	3/4"	SS Edger	\$11.85	1 lb
T-EI1RCS	1"	SS Edger	\$11.85	1 lb
T-EI15RCS	1-1/2"	SS Edger	\$11.85	1 lb
T-EI2RCS	2"	SS Edger	\$11.85	1 lb



EZ-Grip Handle Trowels

- Smaller Handle
- Reduces Hand Tension
- Fingertip Protection

Shown with removable hanging display tag.



WIND-LOCK® WOOD HANDLE TROWELS

1. Right and Left Handed 90° Corner Edgers

Stainless steel.

Part Code	Size	Description	Contr Price	Approx Wt
T-90L75	3/4" x 3/4"	Left Wood	\$11.75	1 lb
T-90L1	1" x 1"	Left Wood	\$11.75	1 lb
T-90L15	1-1/2" x 1-1/2"	Left Wood	\$11.75	1 lb
T-90L2	2" x 2"	Left Wood	\$11.75	1 lb
T-90LKIT	All Sizes	—	\$42.65	2 lb
T-90R75	3/4" x 3/4"	Right Wood	\$11.75	1 lb
T-90R1	1" x 1"	Right Wood	\$11.75	1 lb
T-90R15	1-1/2" x 1-1/2"	Right Wood	\$11.75	1 lb
T-90R2	2" x 2"	Right Wood	\$11.75	1 lb
T-90RKIT	All Sizes	—	\$42.65	2 lb

2. Right and Left Handed 45° Corner Edgers

Stainless steel.

Part Code	Size	Description	Contr Price	Approx Wt
T-45L1	1-1/4" x 1-1/4"	Left Wood	\$11.75	1 lb
T-45L15	2" x 2"	Left Wood	\$11.75	1 lb
T-45L2	2-3/4" x 2-3/4"	Left Wood	\$11.75	1 lb
T-45LKIT	All Sizes	—	\$31.95	2 lb
T-45R1	1-1/4" x 1-1/4"	Right Wood	\$11.75	1 lb
T-45R15	2" x 2"	Right Wood	\$11.75	1 lb
T-45R2	2-3/4" x 2-3/4"	Right Wood	\$11.75	1 lb
T-45RKIT	All Sizes	—	\$31.95	2 lb

3. Outside Corner Edgers

Stainless steel.

Part Code	Size	Description	Contr Price	Approx Wt
T-E75	3/4" x 3/4"	Outside Wood	\$10.75	1 lb
T-E1	1" x 1"	Outside Wood	\$10.75	1 lb
T-E15	1-1/2" x 1-1/2"	Outside Wood	\$10.75	1 lb
T-E2	2" x 2"	Outside Wood	\$10.75	1 lb
T-EKIT	All Sizes	—	\$37.75	2 lb

4. Inside Corner Edgers

Stainless steel.

Part Code	Size	Description	Contr Price	Approx Wt
T-EI75	3/4" x 3/4"	Inside Wood	\$10.75	1 lb
T-EI1	1" x 1"	Inside Wood	\$10.75	1 lb
T-EI15	1-1/2" x 1-1/2"	Inside Wood	\$10.75	1 lb
T-EI2	2" x 2"	Inside Wood	\$10.75	1 lb
T-EIKIT	All Sizes	Inside Wood	\$37.75	2 lb

5. Inside/Outside Corner Trowels

Stainless steel.

Part Code	Size	Description	Contr Price	Approx Wt
T-CTIS	4" x 4"	Inside Wood	\$16.25	1 lb
T-CTOS	4" x 4"	Outside Wood	\$16.25	1 lb

6. Margin Trowels

Stainless steel.

Part Code	Size	Description	Contr Price	Approx Wt
T-M358	1-1/2" x 3-5/8"	SS Wood	\$8.75	1 lb
T-M55	2" x 5-1/2"	SS Wood	\$8.75	1 lb
T-M7	1-1/2" x 7"	SS Wood	\$8.75	1 lb
T-SSMKIT	All Sizes	—	\$22.95	2 lb

7. Pointed and Round Detail Trowels

Stainless steel.

Part Code	Size	Description	Contr Price	Approx Wt
T-PDT	6-1/2" x 2-3/8"	Pointed Wood	\$8.35	1 lb
T-RDT	5-1/2" x 3-1/4"	Rounded Wood	\$8.35	1 lb
T-DTKIT	All Sizes	Detailing Kit	\$14.95	1 lb



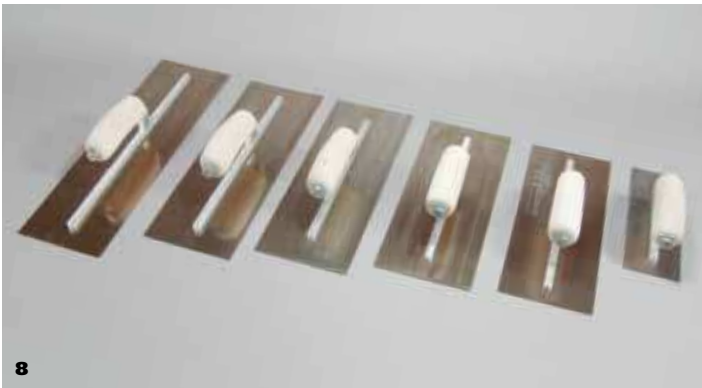

8



9



10



11



12

8. Marshalltown® Camel Back Trowels

Golden stainless steel, wood handle.

Part Code	Size	Description	Contr Price	Approx Wt
T-P115	4-3/4" x 11-1/2"	GSS Wood	\$36.95	1 lb
T-P12	5" x 12"	GSS Wood	\$39.50	2 lb
T-P13	5" x 13"	GSS Wood	\$40.15	2 lb
T-P14	5" x 14"	GSS Wood	\$47.85	2 lb
T-P16	5" x 16"	GSS Wood	\$49.15	2 lb
T-P83	3" x 8"	CRS Wood Midget	\$30.25	1 lb

9. Marshalltown® DuraSoft Trowels

- Golden Stainless Steel
- Soft Handled PermaShape® Blade

Part Code	Size	Description	Contr Price	Approx Wt
T-DS115	4-3/4" x 11-1/2"	GSS DuraSoft	\$45.25	1 lb
T-DS12	5" x 12"	GSS DuraSoft	\$49.75	1 lb
T-DS13	5" x 13"	GSS DuraSoft	\$50.95	2 lb
T-DS14	5" x 14"	GSS DuraSoft	\$51.50	2 lb
T-DS16	5" x 16"	GSS DuraSoft	\$57.75	2 lb

10. Marshalltown® Margin Trowels

Carbon steel, hardwood handle.

Part Code	Size	Description	Contr Price	Approx Wt
T-M515	1-1/2" x 5"	CRS Wood	\$14.75	1 lb
T-M52	2" x 5"	CRS Wood	\$15.75	1 lb
T-M62	2" x 6"	CRS Wood	\$19.75	1 lb
T-M82	2" x 8"	CRS Wood	\$23.75	1 lb
T-SMKIT	All Sizes	CRS Wood	\$69.75	2 lb

11. Kraft® Pool Trowels

Stainless steel, wood handle.

Part Code	Size	Description	Contr Price	Approx Wt
T-KPL10	10" x 3"	SS Wood	\$28.95	1 lb
T-KPL12	12" x 3-1/2"	SS Wood	\$29.90	1 lb
T-KPL14	14" x 4"	SS Wood	\$31.90	1 lb
T-KPL16	16" x 4"	SS Wood	\$33.90	1 lb

12. Curry® Finishing Trowels

Part Code	Size	Description	Contr Price	Approx Wt
T-C101C	5" x 12"	SS Wood	\$32.25	1 lb
T-C102C	5" x 13"	SS Wood	\$34.85	1 lb
T-C103C	5" x 14"	SS Wood	\$34.85	1 lb
T-C4511	4-1/2" x 11"	SS Wood	\$32.25	1 lb
T-C45115	4-1/2" x 11-1/2"	SS Wood	\$32.25	1 lb
T-C47115	4-3/4" x 11-1/2"	SS Wood	\$32.25	1 lb
T-CSS516C	5" x 16"	SS Wood	\$32.25	1 lb

Other sizes available. Call for details.

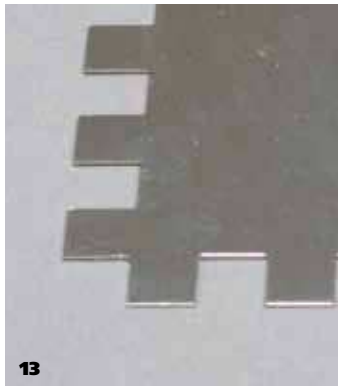

13



14

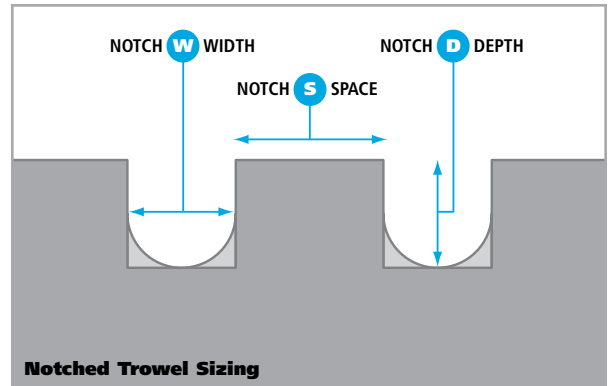

13

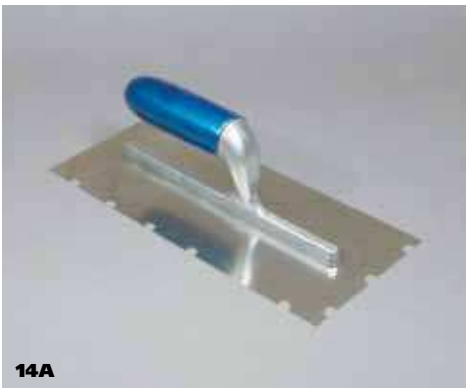

14A



14B

EXCLUSIVE PRODUCT

13. Square Notched Trowel

Stainless steel, wood handle, 5" x 12" trowel.

Part Code	Notch Size (W x D x S)	Description	Contr Price	Approx Wt
T-N532	5/32" x 5/32" x 5/32"	SS Wood	\$16.15	1 lb
T-N516	5/16" x 5/16" x 5/16"	SS Wood	\$16.15	1 lb
T-N732	7/32" x 7/32" x 7/32"	SS Wood	\$16.15	1 lb
T-N38	3/8" x 3/8" x 3/8"	SS Wood	\$16.15	1 lb
T-N58	5/8" x 5/8" x 5/8"	SS Wood	\$24.75	1 lb

Custom Notched Trowel

Options include stainless steel or carbon steel, wood or Comfort-Soft™ handle, square or round notches, and left-handed orientation.

Part Code	Size	Description	Contr Price	Approx Wt
CUSTOM-12	5" x 12"	SS Wood	\$31.75	1 lb
CUSTOM-DNC12	5" x 12"	SS Comfort-Soft	\$33.15	1 lb



14. Round Notched Trowel

Stainless steel, wood or Comfort-Soft™ handle, 5" x 12" trowel.

Part Code	Notch Size (W x D x S)	Description	Contr Price	Approx Wt
A T-N1212	1/2" x 1/2" x 1/2"	SS Wood	\$24.75	1 lb
A T-N122P	1/2" x 1/2" x 2"	SS Wood	\$24.75	1 lb
A T-N1415	1/4" x 1/4" x 1-1/2"	SS Wood	\$24.75	1 lb
A T-N31615	3/16" x 1/4" x 1-1/2"	SS Wood	\$24.75	1 lb
A T-N316316	3/16" x 3/16" x 3/16"	SS Wood	\$24.75	1 lb
A T-N31658	3/16" x 3/16" x 5/8"	SS Wood	\$24.75	1 lb
A T-N316D	3/16" x 3/8" x 1 3/4"	SS Wood	\$24.75	1 lb
A T-N381415	3/8" x 1/4" x 1-1/2"	SS Wood	\$24.75	1 lb
A T-N3815	3/8" x 1/2" x 1-1/2"	SS Wood	\$24.75	1 lb
A T-N51675	5/16" x 5/16" x 3/4"	SS Wood	\$24.75	1 lb
A T-N58P	5/8" x 5/8" x 1"	SS Wood	\$24.75	1 lb
B T-DN122P	1/2" x 1/2" x 2"	SS Comfort-Soft	\$24.05	1 lb
B T-DN1415	1/4" x 1/4" x 1-1/2"	SS Comfort-Soft	\$24.05	1 lb
B T-DN31615	3/16" x 1/4" x 1-1/2"	SS Comfort-Soft	\$24.05	1 lb
B T-DN316316	3/16" x 3/16" x 3/16"	SS Comfort-Soft	\$24.05	1 lb
B T-DN31658	3/16" x 3/16" x 5/8"	SS Comfort-Soft	\$24.05	1 lb
B T-DN316D	3/16" x 3/8" x 1-3/4"	SS Comfort-Soft	\$24.05	1 lb
B T-DN381415	3/8" x 1/4" x 1-1/2"	SS Comfort-Soft	\$24.05	1 lb
B T-DN3815	3/8" x 1/2" x 1-1/2"	SS Comfort-Soft	\$24.05	1 lb
B T-DN51675	5/16" x 5/16" x 3/4"	SS Comfort-Soft	\$24.05	1 lb
B T-DN58P	5/8" x 5/8" x 1"	SS Comfort-Soft	\$24.05	1 lb



Left-handed trowel shown.

**Almost
20" Long!**



15



16



17



18

**Perfect
for Venetian
Plaster.**



19

SPECIALTY TROWELS

15. Smoothing Trowel

Stainless steel.

Part Code	Size	Description	Contr Price	Approx Wt
T-STA	5-1/8" x 19-3/4"	HD SS Wood	\$43.50	2 lb

Custom notching available.

16. E-Z Trowel

The E-Z Trowel allows you to coat joints on radius surfaces. It can be used on EIFS, drywall and plaster materials. Made of high density plastic for shape retention and easy cleanup.

Part Code	Size	Description	Contr Price	Approx Wt
T-EZ20	20"	Straight	\$39.00	1 lb
T-EZ26	26"	Straight	\$49.00	1 lb
T-EZC20	20"	Inner Surface Curve	\$39.00	1 lb
T-EZC26	26"	Inner Surface Curve	\$49.00	1 lb
T-EZO20	20"	Outer Surface Curve	\$39.00	1 lb
T-EZO26	26"	Outer Surface Curve	\$49.00	1 lb
T-EZ3K20	20"	Outer, Straight and Inner Kit	\$111.89	3 lb
T-EZ3K26	26"	Outer, Straight and Inner Kit	\$158.15	4 lb

**Buy the Kit
and Save!**

17. Ornamental Tools

Stainless steel trowels designed for detailing of ornate foam shapes and unusual wall surfaces.

Part Code	Size	Description	Contr Price	Approx Wt
T-OT10	10 mm	Each	\$11.95	1 lb
T-OT16	16 mm	Each	\$12.95	1 lb
T-OT20	20 mm	Each	\$13.50	1 lb
T-OT26	26 mm	Each	\$13.95	1 lb
T-OT30	30 mm	Each	\$14.50	1 lb
T-OTKIT	All Sizes	Ornamental Tool Kit	\$56.00	1 lb

18. Japan Scraper Kit

Stainless steel.

For venetian plaster finishes. Rounded edges, 4 sizes: 2", 3", 4" and 4-3/4".

Part Code	Size	Description	Contr Price	Approx Wt
T-JT3290K	2", 3", 4" and 4-3/4"	SS Rounded Trowels	\$15.70	1 lb

19. Comfort-Soft™ Bottle Opener

Part Code	Contr Price	Approx Wt
T-BOOP	\$5.50	1 lb



FLOATS

1. T-PFTAN

#7 texture rounded with pre-broken-in edges. This “non-breakable” ABS plastic float is balanced and has a thin return shaft for a comfortable grip. 5" x 11".

Part Code	Size	Description	Contr Price	Approx Wt
T-PFTAN	5" x 11"	Each	\$9.50	1 lb

CUSTOMIZE YOUR FLOAT! Send us clear black and white logo art (camera ready—not a fax) 1" high x 2-3/4" wide for imprint on your T-PFTAN float order. Order minimum is 4 packs or 48 pieces.

Part Code	Size	Description	Contr Price	Approx Wt
T-LPFTAN	5" x 11"	Tan Float w/Logo	\$9.50	1 lb

2. Plastic Texture

An economical alternative to the T-PFW.

Part Code	Size	Contr Price	Approx Wt
T-PPF	5-1/4" x 11" x 3/32"	\$10.50	1 lb

3. Plastic Texture

For texturing almost any aggregate style finish.

Part Code	Size	Contr Price	Approx Wt
T-PFW	5-1/4" x 11-3/4" x 1/8"	\$10.50	1 lb

4. Plastic Texture

For intermediate texture finishes.

Part Code	Size	Contr Price	Approx Wt
T-PFWHITE	5-1/4" x 11-3/4" x 1/8"	\$10.50	1 lb

5. Pavan Plastic Trowel NEW!

A material texturing float with a unique composition blade.

Part Code	Size	Description	Contr Price	Approx Wt
T-PVR280	11" x 5.12" (280 x 130 mm)	Reinforced Plastic Sicodur Base Trowel	\$16.75	1 lb
T-PVR240	9.45" x 3.45" (240 x 100 mm)	Reinforced Plastic Sicodur Base Trowel	\$15.60	1 lb
T-PVRA200	7.87" x 3.15" (200 x 80 mm)	Sicodur Riveted Base Trowel w/Alum. Support	\$12.50	1 lb
T-PVRA280	11" x 5.12" (280 x 130 mm)	Sicodur Riveted Base Trowel w/Alum. Support	\$16.25	1 lb



Stock to Dock Shipping Guarantee

Products highlighted in yellow are guaranteed to ship within 24 hours or freight costs are **FREE!** Larger orders may require additional lead times. Call for details.

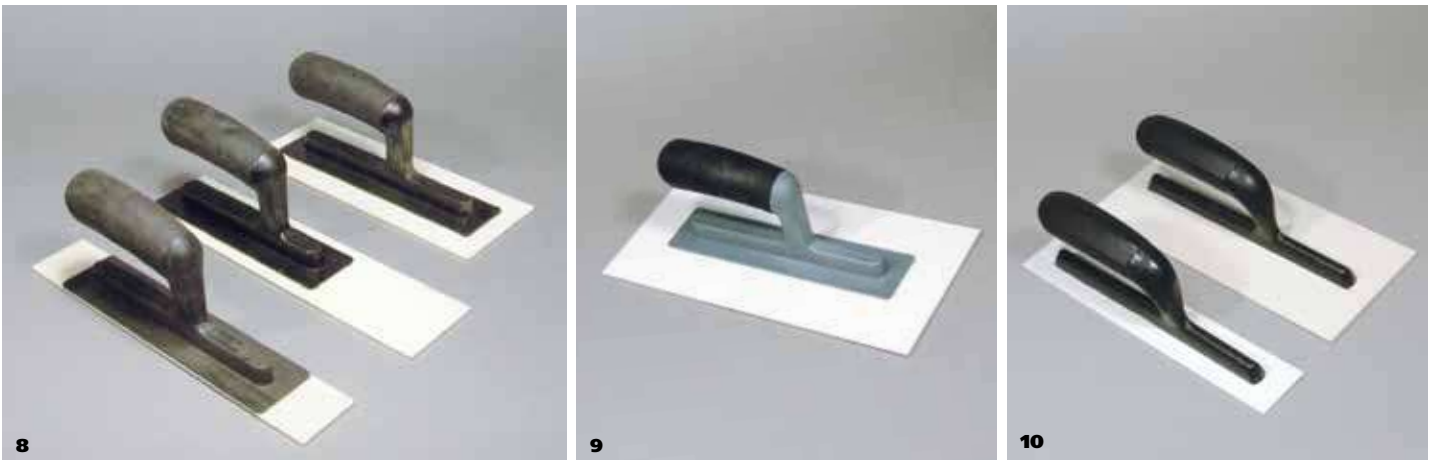
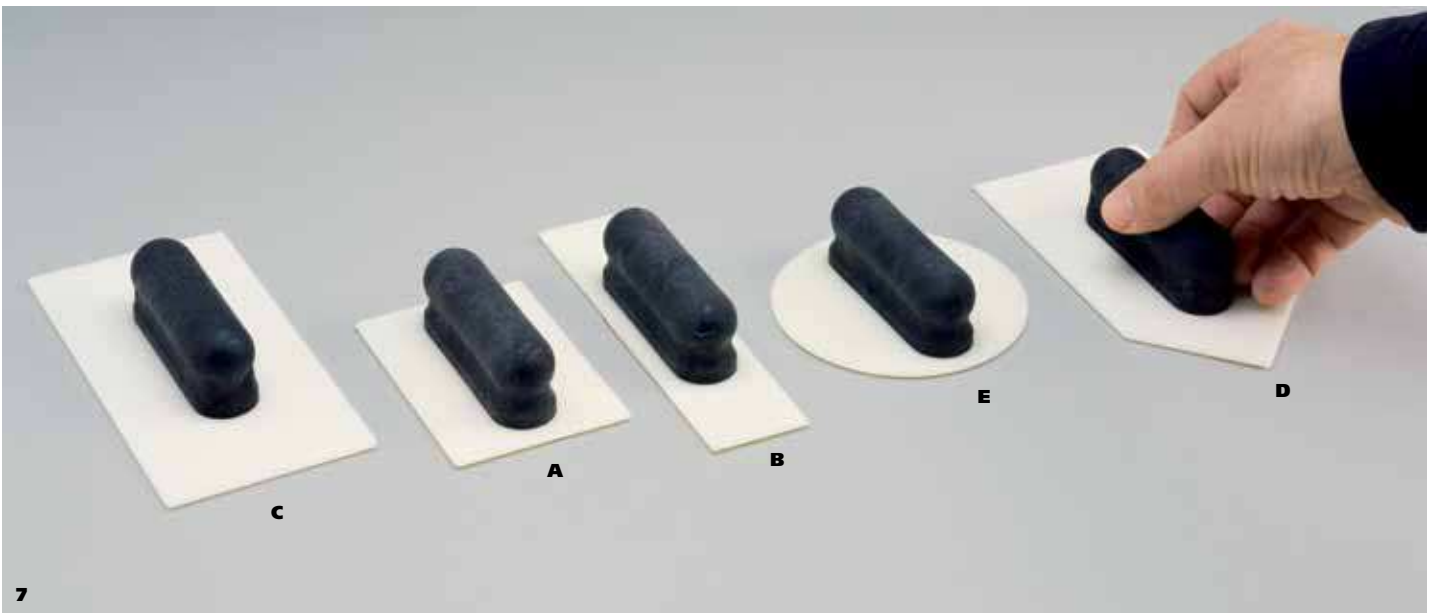

6. NKI Rounded Float **NEW!**

Tapered coned handle. PVC plate with rounded corners. 5" x 11"

Part Code	Size	Description	Contr Price	Approx Wt
W-F400R	5" x 11"	NKI Float with Rounded Edges	\$10.95	1 lb

7. Plastic Small Blade Float

Part Code	Size	Description	Contr Price	Approx Wt	
A	T-PFM107	2-3/4" x 4"	Each	\$4.95	1 lb
B	T-PFM164	1-1/2" x 6-1/4"	Each	\$4.95	1 lb
C	T-PFM168	3-1/8" x 6-1/4"	Each	\$5.15	1 lb
D	T-PFM168SP	3-1/8" x 6-1/4"	Each	\$5.05	1 lb
E	T-PFM100	4"	Each	\$5.05	1 lb
	T-PFMNCK	All 5 Sizes	Mini Plastic Float Kit	\$21.75	1 lb

8. Plastic Medium Blade Float

Part Code	Size	Description	Contr Price	Approx Wt
T-PFM249	3-1/2" x 9-1/2"	Each	\$8.25	1 lb
T-PFM287	2-3/4" x 11"	Each	\$8.25	1 lb
T-PFM285	2" x 11"	Each	\$7.95	1 lb

9. ABS Blade Float

Part Code	Size	Contr Price	Approx Wt
T-PFWHITECS	5-1/4" x 11-3/4"	\$8.99	1 lb

10. Italian Floats

White PVC finishing float.

Part Code	Size	Contr Price	Approx Wt
T-PF286	2" x 11"	\$10.50	1 lb
T-PF2813	5" x 11"	\$11.05	1 lb

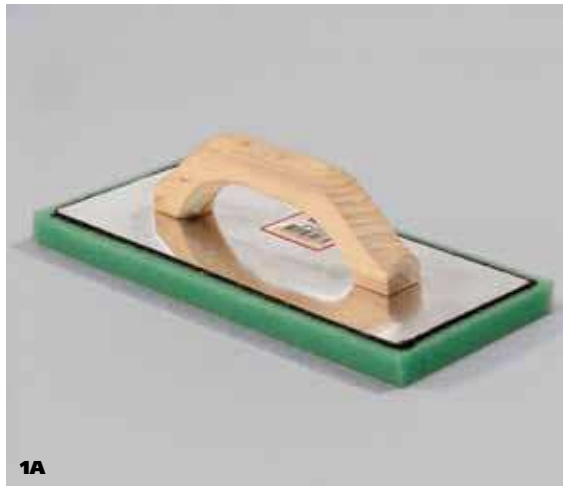

1A

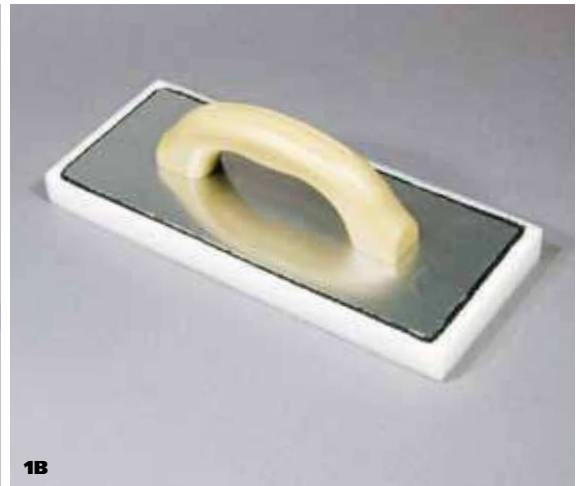

1B



1C

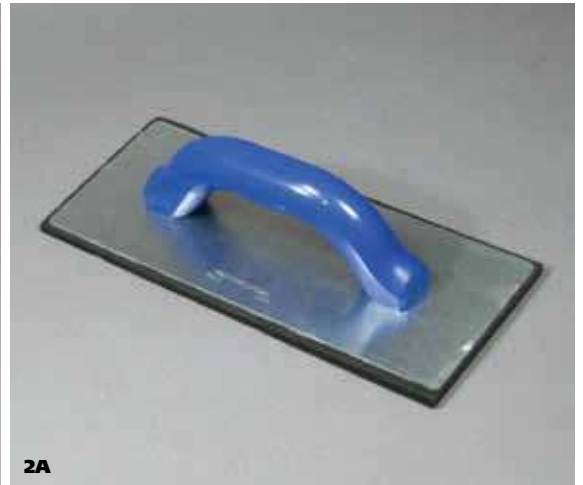

2A

SPONGE FLOATS

1. Sponge Floats

Part Code	Size	Description	Contr Price	Approx Wt
A W-GSF	5" x 12" x 1"	Green Hard	\$5.90	1 lb
A W-GSF34	5" x 12" x 3/4"	Green Hard	\$3.75	1 lb
B W-WSF	5" x 12" x 1"	White Medium	\$5.90	1 lb
C T-RF41212	4" x 12" x 1/2"	Red Hard	\$4.30	1 lb

2. Neoprene

For busy textures on heavy aggregate finishes.

Part Code	Size	Description	Contr Price	Approx Wt
T-FNEO	5" x 12" x 1/8"	Neoprene Float Hard	\$10.75	1 lb
T-NF412	4" x 12" x 1/2"	Brown Neoprene Float Hard	\$5.75	1 lb
T-NF512	5" x 12" x 1/2"	Brown Neoprene Float Hard	\$6.25	1 lb

Great for:

- Stucco
- Plaster
- Cement
- Pools
- Tile/Grout

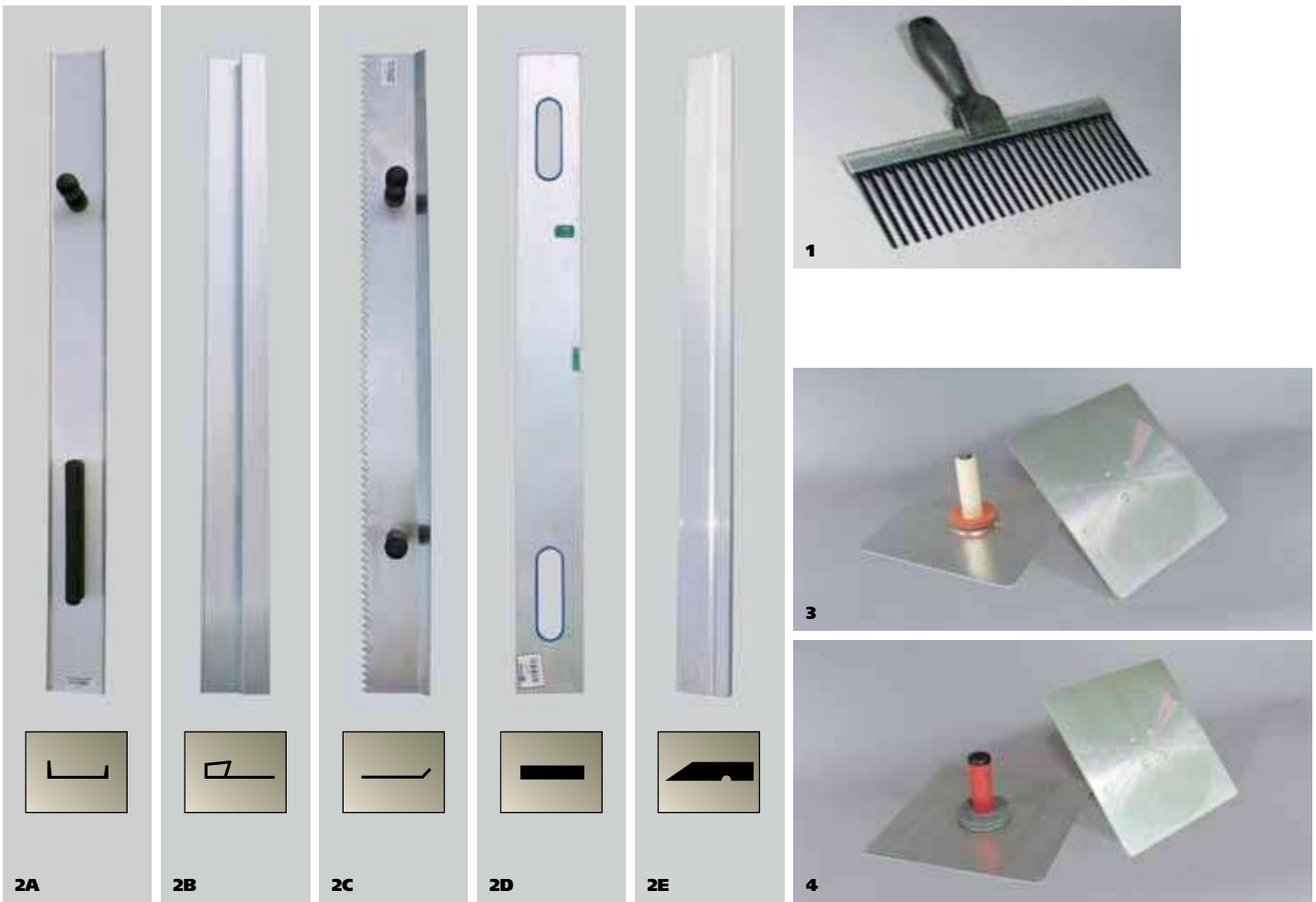

DARBIES/HAWKS

1. 12" Plastic Scarifier

Part Code	Size	Contr Price	Approx Wt
T-PLSC16	12"	\$12.60	1 lb

2. Aluminum Darbies

Lightweight and well-balanced.

Part Code	Size	Description	Contr Price	Approx Wt
A T-DSSM42	42" x 4" x 1/2"	42" Single Serrated Magnesium	\$45.75	2 lb
B HBD-4	48" x 4-3/8" x 1-1/8"	Aluminum Browning H Style	\$25.50	3 lb
B HBD-6	72" x 4-3/8" x 1-1/8"	Aluminum Browning H Style	\$38.25	4 lb
B HBD-8	96" x 4-3/8" x 1-1/8"	Aluminum Browning H Style	\$51.05	5 lb
C T-SCD42	42" x 4-1/2" x 1/2"	Scratcher Darbie	\$21.50	2 lb
D AL-5	59-3/8" x 3-15/16" x 3/4"	Leveling Darbie	\$41.85	2 lb
D AL-6	79" x 3-15/16" x 3/4"	Leveling Darbie	\$52.25	3 lb
D AL-8	98-5/8" x 3-15/16" x 3/4"	Leveling Darbie	\$59.60	4 lb
D AL-10	118-3/8" x 3-15/16" x 3/4"	Leveling Darbie	\$64.30	4 lb
E TBD-4	48" x 3-3/4" x 5/8"	Trapezoid Darbie	\$30.70	3 lb
E TBD-5	60" x 3-3/4" x 5/8"	Trapezoid Darbie	\$38.25	3 lb

3. Kraft® Hawks

Part Code	Size	Description	Contr Price	Approx Wt
T-KH13	13" x 13"	Aluminum Wood Handle	\$21.45	2 lb
T-KH14	14" x 14"	Aluminum Wood Handle	\$22.95	2 lb
T-KHM12	12" x 12"	Magnesium Wood Handle	\$33.90	1 lb
T-KHM13	13" x 13"	Magnesium Wood Handle	\$38.40	2 lb
T-KHM14	14" x 14"	Magnesium Wood Handle	\$43.90	2 lb

4. Marshalltown® Hawks

Part Code	Size	Description	Contr Price	Approx Wt
T-HP10	10" x 10"	Aluminum DuraSoft Handle	\$23.50	1 lb
T-HP12	12" x 12"	Aluminum DuraSoft Handle	\$23.70	2 lb
T-HP13	13" x 13"	Aluminum DuraSoft Handle	\$26.05	2 lb
T-HP135	13-1/2" x 13-1/2"	Aluminum DuraSoft Handle	\$29.40	2 lb
T-H13	13" x 13"	Aluminum Wood Handle	\$24.50	2 lb
T-HM13	13" x 13"	Magnesium DuraSoft Handle	\$45.75	2 lb
T-HM14	14" x 14"	Magnesium DuraSoft Handle	\$50.95	2 lb

**NEW & IMPROVED
BUCKET DREDGER**



Ergonomic grip provides better comfort and superior leverage.



Improved scoop design is easier and lighter to use.



Fewer seams are easier to clean and accumulate less material.



**EXCLUSIVE
PRODUCT**

1



3



4

A

B

C

5

BUCKET ACCESSORIES

1. Bucket Dredger EXCLUSIVE!

NEW improved design for 2010!

- Ergonomic grip
- Easier and lighter to use
- Single piece mold
- Fewer Seams

Part Code	Description	Contr Price	Approx Wt
B-DR	Single	\$13.95	1 lb

2. Mix Fix Bucket Holder

Prevents spinning.

5-gallon bucket holder has 2-foot holders to keep the bucket steady while mixing.

Part Code	Description	Contr Price	Approx Wt
NS T-MF5G	Plastic 5 Gallon Bucket Holder	\$17.95	3 lb

NS=Not shown.

3. Big Dipper

Part Code	Description	Contr Price	Approx Wt
T-BD	CRS Wood	\$17.25	1 lb

4. Bucket Trowel

- Comfort-Soft™ or wood handle
- Stainless steel

Part Code	Description	Contr Price	Approx Wt
T-BTSCS	SS Comfort-Soft	\$16.85	1 lb
T-BTS	SS Wood	\$15.50	1 lb

5. Bucket Openers

Part Code	Description	Contr Price	Approx Wt
A B-BO1	The Hero	\$24.95	1 lb
B B-BO2	3 in 1 Aluminum	\$21.50	1 lb
C B-BO3	Plastic	\$3.50	1 lb



1



3A



3B



3C



2



3D



3E



3F

MIXING AND SPRAYING TOOLS

1. ConTrol™ Nylon Fiber Reinforcement

Fibers for secondary reinforcement to enhance the strength and durability for concrete, mortar and stucco.

Part Code	Qty/Box	Contr Price/Box	Approx Wt/Box
NS I-SCON	1	\$3.35	1 lb
I-CONPOP	36	\$116.00	10 lb
NS I-RCONPOP	150	\$345.65	35 lb

NS=Not shown.

2. 2-Gallon Hopper Gun

Part Code	Contr Price	Approx Wt
W-SHG	\$123.90	7 lb

3. Mixing Blades

Part Code	Size	Description	Contr Price	Approx Wt
A B-M1	23-1/2" x 6-3/8" x 1/2"	Galvanized	\$49.30	3 lb
B B-MEW	32" x 7-1/2" x 1/2"	Inverted	\$66.60	4 lb
C B-MSQ	30" x 8-1/2" x 5"	Square	\$17.95	2 lb
D B-MTW	29" x 8-1/2" x 3/8"	Square Twisted	\$15.80	2 lb
E TR-FBM2	24" x 5" x 3/8"	2 Fixed Wheel	\$12.25	2 lb
F B-MAD	28" x 7-1/2" x 7/16"	Inverted Blade Mixer	\$26.75	3 lb



Stock to Dock Shipping Guarantee

Products highlighted in yellow are guaranteed to ship within 24 hours or freight costs are **FREE!** Larger orders may require additional lead times. Call for details.

TAPES AND FILMS

1. Red Stucco Tape — BEST SELLER!

Weather-resistant stucco tape. The red tape is designed to cover all metal, plastic and vinyl surfaces. Larger widths available upon request. Not for use on glass.

Part Code	Qty/Box	Size	Contr Price/Pc	Approx Wt/Box
W-SRT2	24	2" x 60 yd	\$8.95	27 lb
W-SRT4	12	4" x 60 yd	\$18.55	28 lb

2. Black Stucco Tape

Weather-resistant stucco tape. The black tape is designed to cover all metal, plastic and vinyl surfaces.

Part Code	Qty/Box	Size	Contr Price/Pc	Approx Wt/Box
W-BKT2	24	2" x 60 yd	\$9.25	27 lb
W-BKT4	12	4" x 60 yd	\$17.05	28 lb

3. Filament Tape

Part Code	Qty/Box	Size	Contr Price/Cont	Approx Wt/Box
W-FT1	36	1" x 60 yd	\$4.00	14 lb
W-FT2	24	2" x 60 yd	\$7.35	28 lb

4. Blue Masking Tape

Wind-lock® weather-resistant masking tape is silver to reflect ultraviolet light. The rubber resin adhesive makes it perfect for outdoor holding and protection uses.

Part Code	Qty/Box	Size	Contr Price/Pc	Approx Wt/Box
W-BMT1	36	1" x 60 yd	\$3.75	18 lb
W-BMT15	32	1-1/2" x 60 yd	\$5.75	17 lb
W-BMT2	24	2" x 60 yd	\$7.75	20 lb



5



6



7

5. Window/Door Membrane Flashing

A secondary weather barrier for use around windows, doors or any structural opening. Primer is recommended.

Part Code	Qty/Box	Size	Description	Contr Price/Roll	Approx Wt/Box
W-PWDT4	12	4" x 100' x 30 mil	Flashing Tape	\$32.50	99 lb
W-PWDT6	8	6" x 100' x 30 mil	Flashing Tape	\$50.65	96 lb
W-PWDT9	4	9" x 100' x 30 mil	Flashing Tape	\$77.95	80 lb
W-PWDT12	4	12" x 100' x 30 mil	Flashing Tape	\$100.95	98 lb

6. Bond Breaker Tape

Part Code	Qty/Box	Size	Description	Contr Price/Roll	Approx Wt/Box
W-BBT14	24	1/4" x 108'	Bond Breaker Tape	\$9.50	5 lb
W-BBT38	24	3/8" x 108'	Bond Breaker Tape	\$10.35	5 lb
W-BBT12	18	1/2" x 108'	Bond Breaker Tape	\$13.50	5 lb
W-BBT34	18	3/4" x 108'	Bond Breaker Tape	\$17.50	7 lb
W-BBT1	12	1" x 108'	Bond Breaker Tape	\$18.55	5 lb

7. Window Film Tapes, 200 yards

Larger widths and test rolls are available upon request.

Part Code	Qty/Box	Size	Contr Price/Roll	Approx Wt/Box
W-BFT2	12	2" x 200 yd	\$13.00	27 lb
W-BFT4	6	4" x 200 yd	\$16.00	26 lb
W-BFT6	4	6" x 200 yd	\$19.95	27 lb
W-BFT12	2	12" x 200 yd	\$59.95	27 lb
W-BFT21	1	21" x 200 yd	\$87.00	36 lb
W-BFT24	1	24" x 200 yd	\$89.95	42 lb
W-BFT36	1	36" x 200 yd	\$149.95	52 lb



1



2

FOAM CUTTING EQUIPMENT

1. JobCut

- Cuts 12" at 90°
- Capacity: 2' x 4' x 1'
- Harp moves, not the table
- 110 volts—also available in 220 volts
- Does not include sawhorses or wood
- Folds quickly to only 5" for easy storage
- Cutting Width: 48"
- Cuts from 1° to 90°
- Includes 25' wire

Part Code	Description	Contr Price	Approx Wt
W-JBC	JobCut Hot Wire Machine Only	CALL	70 lb
W-MJBC	JobCut Hot Wire with Magnum	CALL	48 lb

2. Block Buddy

Cornice/ICF Block Cutter.

- Mitters from 0° to 45°
- Cuts 18" deep block
- 24" depth cut at 90°
- 16" depth cut at 45°
- Shaves, cuts and mitters
- Plastic composite tabletop
- Legs fold for easy storage
- Includes 25' wire

Part Code	Description	Contr Price	Approx Wt
W-MBLKB	Block Buddy with Magnum	CALL	49 lb

Other tables available. Call for details.



3. SideWinder

Ornamental 4' Shape cutter.

- Cuts compound miters, straight cuts, columns and decorative mouldings
- 110 volts—also available in 220 volts
- Uses your hardboard template patterns to trace shapes
- (4) 360° pilot bearings
- Capacity: 2' x 2' x 4'
- Table is 48" x 96"
- Includes 50' wire

Part Code	Description	Contr Price	Approx Wt
W-MSW4	4' SideWinder with Magnum	CALL	210 lb

4. StyroCut 15

- Capacity: 15" deep by 4' wide
- Table tilts and locks 0°–45°
- Portable—weighs only 117 pounds
- Designed to cut vertical and horizontal straight cuts, channels, angles and tapers
- Table is 27" x 60"
- Vertical cut foot pedal
- Includes 50' wire

Part Code	Description	Contr Price	Approx Wt
W-MCSTY	StyroCut with Magnum	CALL	165 lb

5. BowCutters and Accessories

Free form cutters.

Part Code	Description	Contr Price	Approx Wt
I-BC12	12" BowCutter with Power Box	CALL	9 lb
I-BC24	24" BowCutter Only	CALL	12 lb
I-BC48	48" BowCutter Only	CALL	19 lb
I-MBC24	24" BowCutter with Magnum	CALL	19 lb
I-MBC48	48" BowCutter with Magnum	CALL	25 lb

6. Hot Wire Kit

Everything you need to build your own 4' hot wire machine.

KIT INCLUDES: Magnum Controller, Gator Cord, 2 insulators, spring, and 100' roll of Nichrome wire.

Part Code	Description	Contr Price	Approx Wt
W-DHW100	Hot Wire Kit	CALL	13 lb

7. Replacement Accessories

Part Code	Description	Contr Price	Approx Wt
NS W-MAGC	Magnum Controller Only	CALL	12 lb
NS W-DGC	4' Gator Cord	CALL	1 lb
NS I-DHW100	100' 23ga Nichrome 80 wire	CALL	1 lb

NS=Not shown.

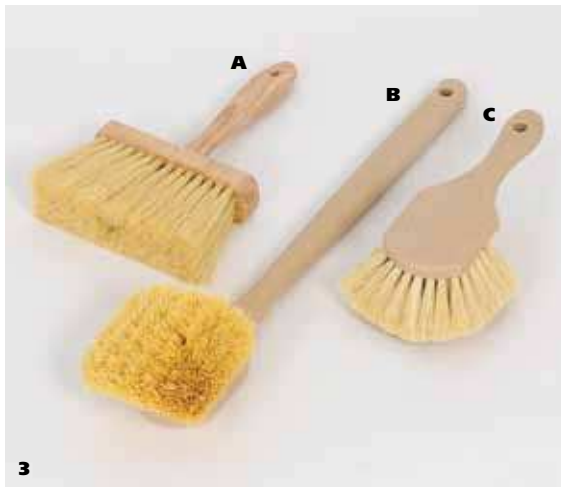

CLEAN-UP

1. Smoothing Brush

Part Code	Size	Contr Price	Approx Wt
B-SM1PK	1"/12 pack	\$29.55	1 lb
B-SM2PK	2"/12 pack	\$41.80	2 lb

2. Blister Brush and Replacement Pad

Part Code	Contr Price	Approx Wt
BB-GB	\$24.95	2 lb
BB-GBR	\$12.35	1 lb

3. Tampico Cleaning Brushes

Part Code	Size	Contr Price	Approx Wt
A B-BB6	6" Bucket Brush	\$9.25	1 lb
B B-BB20	20"	\$7.60	2 lb
C B-GTAB	8-1/2"	\$6.40	1 lb

4. Cellulose Sponge

Part Code	Contr Price	Approx Wt
T-GCS	\$2.90	1 lb

5. Grouting Sponge

Special hydro-philated design has high water-holding capacity.

Part Code	Contr Price	Approx Wt
T-XLGS	\$2.55	1 lb



6

6. Boss® Biggies Industrial Wipes

These dual-sided industrial wipes clean paint, adhesives, oil and more from hands, tools and surfaces.

Part Code	Description	Size	Contr Price
W-BW	Dual-sided abrasive wipes 80 wipes per container	8" x 12"	\$25.95

7. Stretch Wrap

Part Code	Size	Contr Price	Approx Wt
W-SW18	18" x 1500'	\$15.95	36 lb



7



8



9

8. BIG O Tool Cleaner

A citrus cleaner designed for removal of synthetic stucco from tools, equipment and building surfaces. Great for removing adhesives, silicone caulking, decals, ink, asphalt, grease and tar from porous surfaces.

Part Code	Size	Description	Contr Price	Approx Wt/Case
W-AOC	14 oz can	Can of Tool Cleaner	\$11.65	14 lb
W-AOJ	Gallon	Gallon of Tool Cleaner	\$66.35	32 lb

9. Tool Cleaner

Removes synthetic stucco from tools and equipment. Great for cleaning trowel and other often-used hand tools. Helps prolong your tool life.

Part Code	Size	Description	Contr Price	Approx Wt/Case
W-TM	18 oz can	Can of Tool Cleaner	\$10.95	14 lb

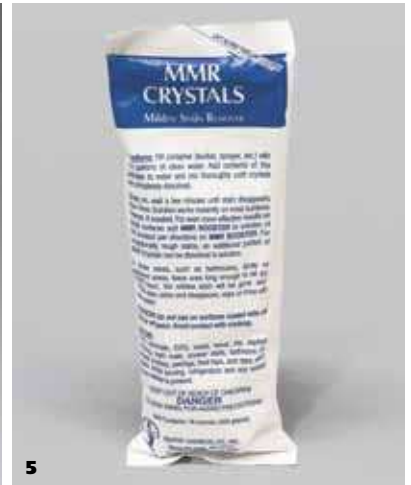

CHEMICALS

1. General Purpose Cleaner

Spray applied to natural masonry, stucco, synthetic stucco and other wall surfaces. Removes dirt, soot and pollution.

Part Code	Size	Contr Price	Approx Wt
MP-2107G	Case of 4 gallons	\$72.99	28 lb

2. Titan Penetrating Sealer

Titan is not a “topical” sealer. Instead, it penetrates the surface voids and “locks-up” surface integrity without forming a vapor barrier. Titan is a reacted silicate sealer with essentially the same chemical makeup as glass (silica), resulting in a non-yellowing, breathable surface.

Part Code	Size	Contr Price	Approx Wt
W-TPS1	Gallon	\$43.00	9 lb
W-TPS5	5 gallons	\$184.00	45 lb

3. Rust Remover & Phosphatizer

This clear, liquid, chemical compound reverses the process that causes rusting and oxidation. It destroys the corrosive agents that support rust and leaves a clean, phosphatized, paintable surface.

Part Code	Size	Contr Price	Approx Wt
MP-G2108	Gallon	\$22.95	7 lb

4. Efflorescence Remover

Sprays into natural masonry, stucco, synthetic stucco and other wall surfaces. Removes efflorescence and other acid-soluble stains. 400 square feet of coverage.

Part Code	Size	Contr Price	Approx Wt
MP-G2112	Case of 4 gallons	\$72.99	28 lb

5. Miracle Mildew Remover

Removes mildew from stucco surfaces and building faces. 500 ft coverage.

Part Code	Size	Contr Price	Approx Wt
W-MMRC	1 bag	\$12.80	1 lb

6. Rubber Coated Gloves

Part Code	Size	Contr Price	Approx Wt
NS W-10CG	10 pack	\$13.50	1 lb

NS=Not shown.

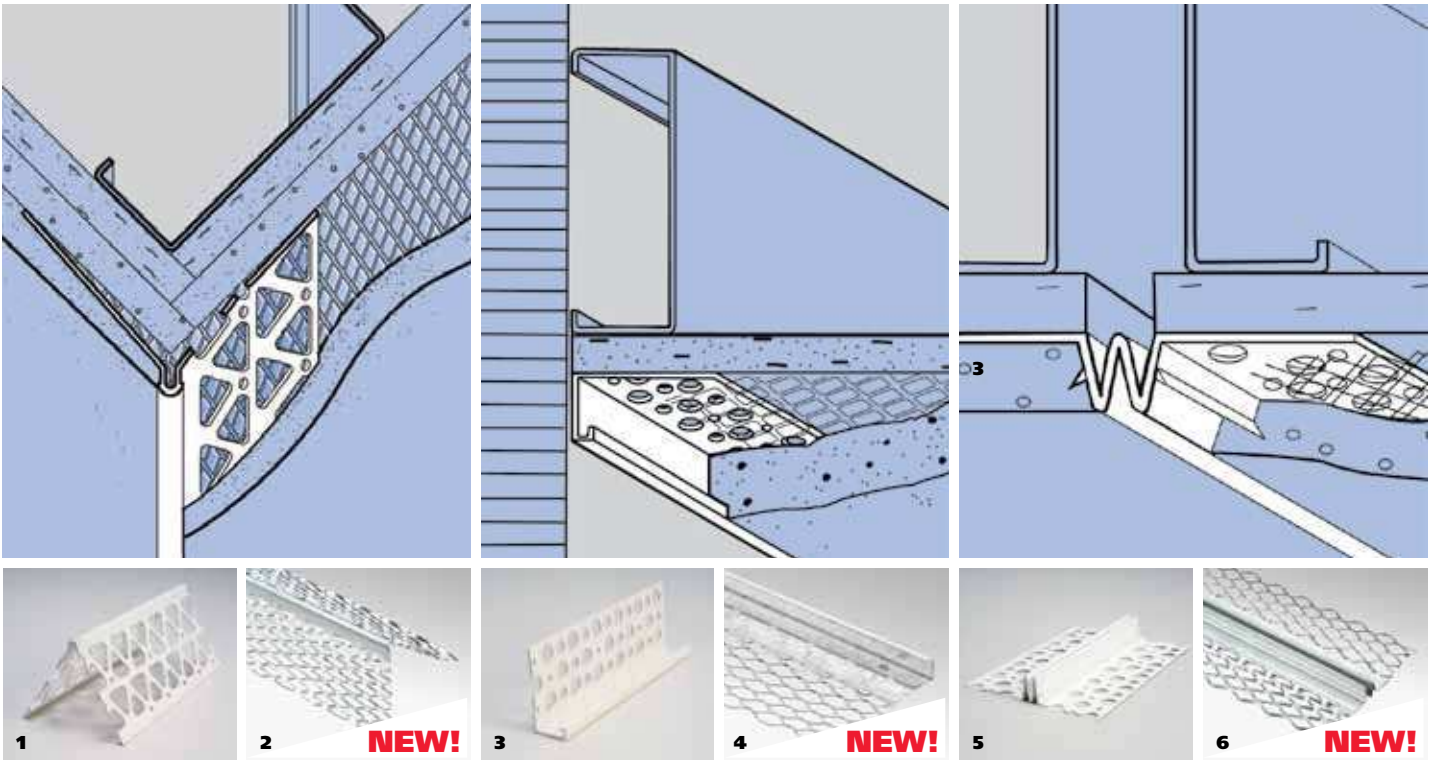

STUCCO AND PLASTER ACCESSORIES

1. Vinyl Corner Beads

Vinyl corners provide hard-to-damage, rust-proof straight corners. They are easily curved to create for smooth arches.

Part Code	Qty/Box	Ground	Description	Contr Price/Pc	Approx Wt/Bx
W-CB8	50	ANY	8' with 2-1/2" perforated flanges	CALL	45 lb

2. Metal Corner Beads **NEW!**

Phillips #1 Expanded Corner Bead provides strong corner reinforcement for conventional plaster applications. Solid nose provides straight, rigid ground and 2-5/8" flanges can be flexed over uneven surfaces. Plaster keys near solid nose help ensure straight corners. Phillips #33 Wide Expanded Flange Bead provides rigidity for masonry, beams, and column fireproofing.

Part Code	Qty/Box	Ground	Description	Contr Price/Pc	Approx Wt/Bx
W-CB01E	40	ANY	8' with #1 Expanded Flange	CALL	TBD
W-CB33W	40	ANY	8' with #33 Wide Flange	CALL	TBD
W-CBEV	60	ANY	8' Expanded Veneer	CALL	TBD

3. Vinyl Casing Beads/Plaster Stops

Vinyl corner beads are used to terminate stucco and plaster against doors, windows and dissimilar materials.

Part Code	Qty/Box	Ground	Description	Contr Price/Pc	Approx Wt/Bx
W-CBPS50	100	1/2"	1-3/4" perforated flange	CALL	80 lb
W-CBPS75	75	3/4"	1-3/4" perforated flange	CALL	60 lb

4. Metal Casing Beads/Plaster Stops **NEW!**

Phillips #66 Expanded Flange Square Casing is a universal plaster stop for wall terminations, openings and intersections, and protects edges from damage and helps cover shrinkage cracks.

Part Code	Qty/Box	Ground	Description	Contr Price/Pc	Approx Wt/Bx
W-CBPSEF1	30	1"	8' with #66 Expanded Flange	CALL	55 lb
W-CBPSEF3	30	3/8"	8' with #66 Expanded Flange	CALL	51 lb
W-CBPSEF5	30	1/2"	8' with #66 Expanded Flange	CALL	51 lb
W-CBPSEF6	30	3/4"	8' with #66 Expanded Flange	CALL	51 lb
W-CBPSEF7	30	5/8"	8' with #66 Expanded Flange	CALL	49 lb
W-CBPSSF3	30	3/8"	8' with #66 Expanded Flange	CALL	51 lb
W-CBPSSF5	30	1/2"	8' with #66 Expanded Flange	CALL	40 lb
W-CBPSSF6	30	5/8"	8' with #66 Expanded Flange	CALL	51 lb
W-CBPSSF7	30	3/4"	8' with #66 Expanded Flange	CALL	44 lb
W-CBPSSF8	30	7/8"	8' with #66 Expanded Flange	CALL	44 lb

5. Vinyl Control Joints

Vinyl joints are designed to relieve stress and assist in controlling cracking in large areas of walls and ceilings. Specially designed connector clips are provided for alignment and base for sealants.

Part Code	Qty/Box	Ground	Description	Contr Price/Pc	Approx Wt/Bx
W-CJ50	35	1/2"	4" perforated flange	CALL	49 lb
W-CJ75	26	3/4"	4" perforated flange	CALL	40 lb

6. Metal Control Joints **NEW!**

Phillips #15 Double V Expansion Joint relieves expansion and contraction stresses during stucco curing. Phillips #15 minimizes plaster cracking and helps ensure proper plaster or stucco thickness.

Part Code	Qty/Box	Ground	Description	Contr Price/Pc	Approx Wt/Bx
W-CJE3	24	3/8"	8' with #15 3/8" Expansion Joint	\$1.79	TBD
W-CJE5	24	1/2"	8' with #15 1/2" Expansion Joint	\$1.84	TBD

For additional stucco and plaster trims, see pages 22 and 23.



1



2



3



4



5



6

STONE VENEER TOOLS

1. Stone Veneer Kit

KIT INCLUDES: canvas tool bag, 14" stone nipper, 4" x 8-3/4" chisel, 11-1/2" x 4-3/4" Comfort-Soft™ plastering trowel, R11 Hammer Tacker, 6-1/2" Mortar hoe, Reload reel, pointed detail trowel, 7/16" x 7" Aesthetic detail, 8-1/2" Tampico Brush, 12" Plastic Scarifier, 3 12" x 23" grout bags.

Part Code	Description/Size	Contr Price	Approx Wt
W-STVK	Stone Veneer Kit	\$278.45	18 lb

2. Stucco Rub Brick

Smooth hardened stucco surfaces.

Part Code	Size	Contr Price	Approx Wt
T-RB6	3" x 6" x 1"	\$13.55	2 lb

3. Stone Nipper

Made from high-grade tool steel, deep tempered.

Part Code	Description/Size	Contr Price	Approx Wt
T-STN	14" Stone Nipper	\$52.50	2 lb

4. Brick Hammer

20 oz., solid steel brick hammer with soft grip handle. Designed for breaking, trimming and cleaning brick.

Part Code	Description/Size	Contr Price	Approx Wt
T-SBH	20 oz. Brick Hammer	\$30.15	2 lb

5. Mason's Chisel

Slip-resistant grooved rubber grip, 5" long handle.

Part Code	Description/Size	Contr Price	Approx Wt
T-CH	4" x 8 3/4"	\$25.75	2 lb

6. Disposable Plastic Grout Bag

Made of heavy duty plastic. Tips can be cut to the desired opening. Disposable, eliminates the need for cleanup.

Part Code	Description/Size	Contr Price	Approx Wt
T-GBD	21" x 11"	\$16.95/Box of 50	4 lb



7



8



9



10



11



12



13

NEW!

7. Poly Grout Bag

Poly molded permanently in bag, 3/8" tip, 12" wide at top.

Part Code	Description/Size	Contr Price	Approx Wt
T-GBP	12" x 23"	\$4.95/Each	1 lb

8. Hammer Tacker Rapid R11

Medium duty, easy to load, easy to operate. All-steel construction. Designed for high-speed tacking over large areas.

Part Code	Description/Size	Contr Price	Approx Wt
T-HTRR11	Medium Duty Tacker	\$47.40	2 lb
T-STHT1/4	1/4" staples, 5,000 per box	\$3.85	1 lb

9. Heavy-Duty Utility Tub

Made from heavy gauge hi-molecular weight polyethylene.

Part Code	Description/Size	Contr Price	Approx Wt
T-CT	23" x 16" x 6" Tub	\$36.75	3 lb

For Additional Rainscreen and Weatherization Products, go to page 85.

10. Short Handled Hoe

6-1/2" blade with a 21" handle.

Part Code	Description/Size	Contr Price	Approx Wt
T-HM65	Short Handled Hoe	\$28.80	1 lb

11. Mortar Hoe

7" blade with a 60" wood handle.

Part Code	Description/Size	Contr Price	Approx Wt
T-HM7	Mortar Hoe	\$39.00	3 lb

12. Reload Reel

Yellow reload reel with line, designed with a thumb brake and auto winder.

Part Code	Description/Size	Contr Price	Approx Wt
T-RRY	500' Roll #18 Braid	\$17.95	1 lb

13. Benjamin Obdyke Home Slicker® Stone & Stucco NEW!

Home Slicker® Stone & Stucco is the only vertically channeled rainscreen that has been specifically designed for use with manufactured stone, natural stone, stucco, and masonry applications.

Part Code	Qty/Skid	Size	Description	Contr Price	Approx Wt
W-HSST	9	39"x61.5' 200 sq ft	Stone & Stucco Rainscreen 6 mil	\$137.45	16 lbs
NS W-HS10ST	9	39"x38.5' 125 sq ft	Stone & Stucco Rainscreen 10 mil	\$113.25	25 lbs

NS=Not shown.



PERMALATH® GLASS FIBER LATH FOR STUCCO AND STONE

*Now Available to
Everyone, Nationally
Through Wind-lock®.*

PermaLath® is an open weave, corrosion-free, three-dimensional, self-furring, glass fiber reinforcing lath.

FEATURES AND BENEFITS

Non Metallic

Will not rust; ideal for coastal applications

Pliable, with No Sharp Edges

Safer and easier to cut and handle

Non-Directional

Can be applied vertically or horizontally

Wide Rolls

Fewer overlaps required to give better coverage

Three-Dimensional Profile

Self-furring, excellent mechanical key using traditional fastening procedures

Low Profile on Overlaps

Overlaps are easily feathered, eliminating shadowing

Alkali Resistant

Long-term durability and performance

Packaged in Lightweight Rolls

Application time/labor savings/storage

PermaLath® Glass Fiber Lath

PermaLath® is a nominal 1/8" thick glass fiber reinforcing lath designed for use with cementitious exterior wall coatings manufactured in accordance with ICC-ES AC-11 at a maximum thickness of 3/8" to 1/2". PermaLath® provides keying and continuous reinforcement for stucco used on vertical wall applications with solid backing.

Part Code	Qty	Size	Description	Contr Price	Approx Wt
I-PL	1 Roll	39" x 150'	1/8" Fiberglass Lath 487.5 sq ft	CALL	16 lb

*Note: 20 Rolls per Skid 39" x 150', 1/8" Fiberglass Lath
9,750 sq ft, 375 lb per skid.*

PermaLath® 1000 Glass Fiber Lath

PermaLath® 1000 is a nominal 1/4" thick glass fiber reinforcing lath designed for use with cementitious exterior wall coatings (traditional stucco) at a maximum thickness of 1/2" to 7/8". PermaLath® 1000 can also be used as a mortar base for lightweight veneer facing, such as stone veneer.

Part Code	Qty	Size	Description	Contr Price	Approx Wt
I-PL1000	1 Roll	39" x 150'	1/4" Fiberglass Lath 487.5 sq ft	CALL	31 lb

*Note: 8 Rolls per Skid 39" x 150', 1/4" Fiberglass Lath
3,900 sq ft, 303 lb per skid.*



1

NEW!

2



3

NEW!

2

NEW!

3



4

NEW!

BENJAMIN OBDYKE HOME SLICKER® AND BLOCKADE™

1. Home Slicker® Stone & Stucco **NEW!**

The only vertically channeled rainscreen that has been specifically designed for use with manufactured stone, natural stone, stucco and masonry applications. Each roll contains the patented Home Slicker® three-dimensional matrix bonded to a fabric which prevents mortar from entering the wall cavity during cladding installation. This product installs with the fabric facing outward.

Part Code	Qty/Skid	Size	Description	Contr Price	Approx Wt
W-HSST	16	39" x 61.5' 200 sq ft	Stone & Stucco Rainscreen 6 mil	\$137.45	16 lb
NS W-HS10ST	16	39" x 38.5' 125 sq ft	Stone & Stucco Rainscreen 10 mil	\$113.25	25 lb

NS=Not shown.

2. Home Slicker® Plus Typar® **NEW!**

A cost-effective, labor and material saving, moisture eliminating rainscreen combined with a water resistive barrier. Each roll contains the patented Home Slicker® three-dimensional matrix bonded to Typar®, the premium residential and commercial grade housewrap.

Part Code	Qty/Skid	Size	Description	Contr Price	Approx Wt
W-HSPT	16	39" x 61.5' 200 sq ft	Plus Typar Rainscreen 6 mil	\$137.45	15 lb
NS W-HS10PT	16	39" x 38.5' 125 sq ft	Plus Typar Rainscreen 10 mil	\$113.25	15 lb

NS=Not shown.

3. Home Slicker® **NEW!**

The unique, vertically-channeled, three-dimensional matrix of the original Home Slicker® provides a continuous space for drainage and drying, a thermal break and pressure equalization—eliminating the threat of trapped moisture. Home Slicker® 10 is designed to meet the 10mm code requirements in Canada.

Part Code	Qty/Skid	Size	Description	Contr Price	Approx Wt
W-HS	16	39" x 46.5' 150 sq ft	Rainscreen 6 mil	\$88.05	10 lb
NS W-HS10N	16	39" x 38.5' 125 sq ft	Rainscreen 10 mil	\$86.30	8 lb

NS=Not shown.

4. Benjamin Obdyke Blockade™ **NEW!**

Designed specifically for use in brick wall cavities, the entangled matrix design of the Blockade™ Mortar Deflection System blocks mortar from clogging the weep holes and allows excess moisture to flow freely out of the wall cavity. The result is a brick wall that is built to stand the test of time and remains free from the deteriorating effects of mold and mildew.

Part Code	Qty/Skid	Size	Description	Contr Price	Approx Wt
W-BA80	16	50'x10"x.80"	80 Mortar Deflection .80" thick	\$37.50	5 lb
W-BA150	16	50'x10"x1.5"	80 Mortar Deflection 1.5" thick	\$56.35	4 lb

ICF & SIP

BUILDING SOLUTIONS

Insulating Concrete Forms (ICFs) and Structural Insulated Panels (SIPs) represent innovative and dependable choices for responding to a wide variety of building challenges. Wind-lock® ICF and SIP help ensure that these technologies will be an efficient and cost-effective solution as well, with high-quality specialized tools for cutting, fabricating, gluing and finishing.

58
60
64
67
68
70
71
75
76

FOAM AND FOAM GUNS



FOAM2FOAM®
PAGE 58

HOT KNIVES



BUCK PLATES
PAGE 67

ICF STRUCTURAL SOLUTIONS

ICF BUCK FASTENERS

SIP

ICF MOISTURE CONTROL

INSTALLATION ESSENTIALS

ICF FORM FABRICATING

TAPCO BRACING SOLUTIONS



**ICF SUPER
GROOVER™**
PAGE 69



INSUL-KNIFE
PAGE 75



GIVING YOU THE BEST PRODUCTS AND SERVICE

Our commitment is more than delivering the finest tools, accessories and specialized products. We've made the same commitment to giving you the best customer service available. That means technical expertise and consulting to help projects go more smoothly and quickly. Our project know-how includes productivity tips, work procedure advice, application technique refinement and other contributions toward fast installation and quality results. Just ask us.





1



3A



3B

NEW!



4

FOAM2FOAM® GUN FOAMS

EXCLUSIVE PRODUCT

ICF Contractors' Preferred Foam Adhesive.



A multi-purpose, professional, low-expansion construction adhesive and gap and crack filler. Great for ICF, SIP and EIFS and stone veneer applications. One component polyurethane foam. Cures by absorbing water vapor from the air.

- Used for filling, sealing, and insulating joints and cracks
- Professional quality
- Accurately controlled application
- Moisture-curing
- Acoustical sealant
- Drywall adhesive: reduces fasteners by 60%
- Excellent adhesion to most surfaces
- Temperature, water and chemical resistant
- No CFC/HCFC
- Stone veneer adhesive
- Compatible with EPS foam boards
- Paintable and can be plastered over

Consult your system manufacturer for specific recommendations.

1. W-F2F® Foam and Cleaner

Part Code	Description	Contr Price	Approx Wt
W-F2F24	Wind-lock Foam2Foam Case	CALL	22 lb
NS W-PGCS	F2F Gun Cleaner 12 oz Case	CALL	13 lb

NS=Not shown.

2. F2F® Sampler Kit

KIT INCLUDES: 1 Can F2F®, 1 Can F2F® Cleaner, 1 W-EG13T Foam Gun, 1 Pair Protective Rubber Coated Gloves.

Part Code	Description	Contr Price	Approx Wt
NS W-F2FKIT	Wind-lock F2F Kit	CALL	6 lb

NS=Not shown.

3. Contractors' Choice Value Kit **NEW!**

KIT INCLUDES: Cans of F2F®, 1 Can of F2F® Cleaner, 1 W-EG13T Foam Gun, 1 Pair Protective Rubber Coated Gloves.

Part Code	Description	Contr Price	Approx Wt
A W-CC9	Kit incl. 9 Cans of F2F	CALL	20 lb
B W-CCV11	Kit incl. 11 Cans of F2F	CALL	22 lb

4. 11/1 Foam Convenience Kit

KIT INCLUDES: 1 Can of F2F® Cleaner, 11 Cans of F2F®.

Part Code	Description	Contr Price	Approx Wt
W-CLF2F	11/1 Foam Convenience Kit	CALL	23 lb



Stock to Dock Shipping Guarantee

Products highlighted in yellow are guaranteed to ship within 24 hours or freight costs are **FREE!** Larger orders may require additional lead times. Call for details.

Buy the Kit and Save!

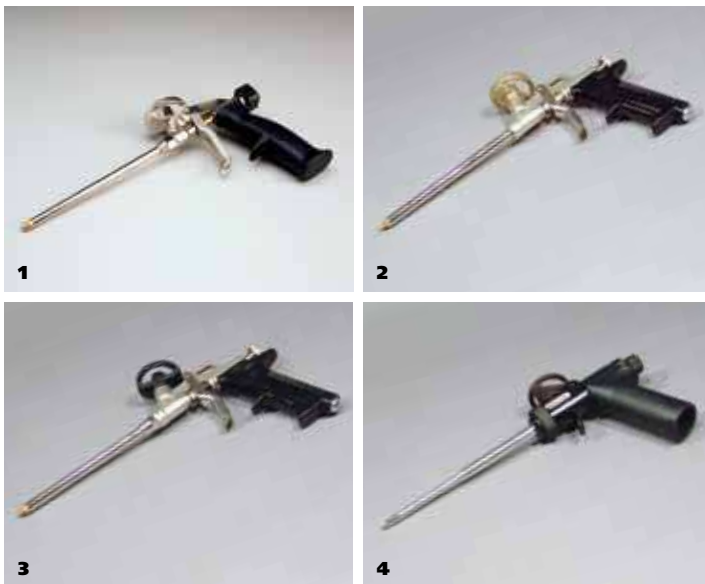

FOAM GUNS

All of our guns are engineered to deliver foam day after day with minimal cleaning. The all-metal needle valve construction delivers the polyurethane foam with controlled accuracy. We offer a wide variety, ranging from “do it yourself” models to professional.

ECONOMY SERIES

1. W-EG13T Taper Tip Foam Dispenser

Light-medium duty gun, featuring all-metal needle valve construction and brass tapered tip with universal can adapter and tip. This is our best gun for filling in EPS board gaps.

Part Code	Description	Contr Price	Approx Wt
W-EG13T	Taper Tip Foam Dispenser	\$35.95	2 lb

2. W-EG13

Light-medium duty gun, featuring all-metal needle valve construction and brass universal can adapter and tip.

Part Code	Description	Contr Price	Approx Wt
W-EG13	Economy Foam Dispenser	\$39.95	2 lb

INTERMEDIATE SERIES

3. W-EG14

Medium duty gun featuring a Teflon® coated needle valve and universal can adapter. The knurled brass dispensing tip is the knurled brass that holds the extension tubes in place. Also available with a 31" long extended barrel for long reach or sub floor applications.

Part Code	Description	Contr Price	Approx Wt
W-EG14	Foam Dispenser with Teflon Tip	\$56.50	2 lb
NS W-EG14L	31" Long Barrel	\$139.75	4 lb
NS W-EG14BT	Brass tips for W-EG14	\$3.75	1 lb

NS=Not shown.

PROFESSIONAL SERIES

4. W-EG15

This professional gun features a narrow tapered tip for dispensing the foam between EIFS board lines. The two-stage tapered barrel blends the foam to a superior consistency.

Part Code	Description	Contr Price	Approx Wt
W-EG15	Pageris Foam Dispenser	\$82.35	2 lb

PROPER ATTACHMENT OF FOAM GUNS



1. Attach the gun to the can of F2F®.

4. Removing the can from a gun, point can upright and away from your face.



2. The can should point up and away from your face.

5. Clean the gun adapter with the F2F® Cleaner.



3. Shake can for 1 minute and purge air from gun.

6. Attach and spray the cleaner through the gun.

Industry Exclusive:
Now with a 3 year warranty.



HOT KNIFE SYSTEMS, BLADES AND ACCESSORIES

EXCLUSIVE PRODUCT



Stock to Dock Shipping Guarantee

Products highlighted in yellow are guaranteed to ship within 24 hours or freight costs are **FREE!** Larger orders may require additional lead times. Call for details.

1. 2-QC Knife

Cuts foam clean with no bead dust. Handle stays cool.
KIT INCLUDES: 2-QC Hot Knife and 4" straight blade.

Part Code	Description	Contr Price	Approx Wt
2-QC	Hot Knife Tool Kit	\$250.85	2 lb
NS 2-BQC	Hot Knife Tool Kit and Gatemouth Jr. Bag	\$280.05	5 lb

NS=Not shown.

2. ICF Super Groover™

Consistent utility service channels and grooves can be cut with one fast, clean pass. The cuts range from 1/2" to 6" wide, with virtually unlimited depth. The Super Groover™ comes standard 110 volt. **KIT INCLUDES:** The Super Groover™, 6" sled, 4" straight blade, 1/2" x 3" square blade, single and double electrical box cutter blades, 2 pieces of 12" flat blade material, and Gatemouth Jr. bag.

- Variable temperature control
- Blade in front for inside corners
- Detachable sled allows straight blade use

Part Code	Description	Contr Price	Approx Wt
I-ICFSG	Super Groover	\$499.95	10 lb
NS I-ICFSGKIT	Super Groover Kit	\$540.95	12 lb

NS=Not shown.

3. ICF Kit

Great starter kit.

KIT INCLUDES: 2-QC Hot Knife, 6" sled, 1/2" x 3" square blade, 4" and 6" straight blades, single and double electrical box cutter blades, 2 pieces of 12" flat blade material.

Part Code	Description	Contr Price	Approx Wt
NS 2-ICFKIT	Concrete Forms Kit	\$364.75	3 lb
2-BICFKIT	Concrete Forms Kit and Gatemouth Jr. Bag	\$393.55	5 lb

NS=Not shown.

4. Ultimate ICF QC Hot Knife Kit NEW!

Our most complete Hot Knife Kit.

KIT INCLUDES: 2 QC Hot Knife, 6" sled, 4" straight blade, hard wire benders, 4" and 6" stud cutter blades, single and double electrical box cutter blades, 1/2" x 3" square blade, radius wall blade, conduit cutter, 2 pieces of 12" flat blade material, 6" UGZ® hand rasp, 12 cans of F2F® foam gun and can of cleaner, Tajima G-Saw and canvas tool bag.

Part Code	Description	Contr Price	Approx Wt
I-UICFQCKIT	Ultimate ICF Wall Fabricator Kit with QC Hot Knife	\$650.95	34 lb

5. Ultimate ICF Super Groover™ Kit NEW!

The ultimate ICF wall fabricator kit. Create radius walls, embed 2" x 6" studs into garage door walls, run electrical wires after the drywall is up, or taper your blocks at the top of the wall for a secure roof connection...this kit has it all!

KIT INCLUDES: The Super Groover™, 6" sled, 4" straight blade, hard wire benders, 4" and 6" stud cutter blades, single and double electrical box cutter blades, 1/2" x 3" square blade, radius wall blade, conduit cutter, 2 pieces of 12" flat blade material, 6" UGZ® hand rasp, 12 cans of F2F® foam gun and can of cleaner, Tajima G-Saw and canvas tool bag.

Part Code	Description	Contr Price	Approx Wt
I-UICFSGKIT	The Ultimate ICF Wall Fabricator Kit with Super Groover	\$750.95	35 lb

Buy the Kit and Save!

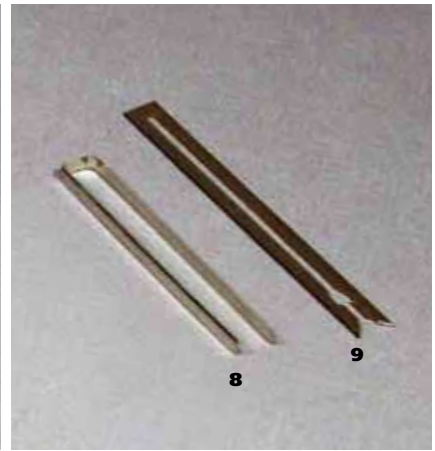
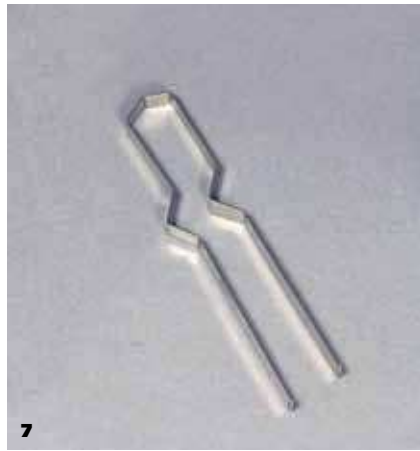
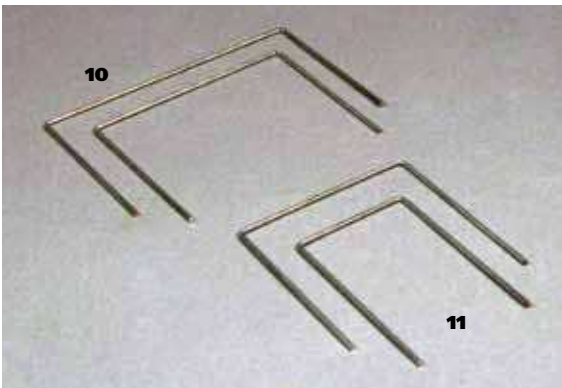
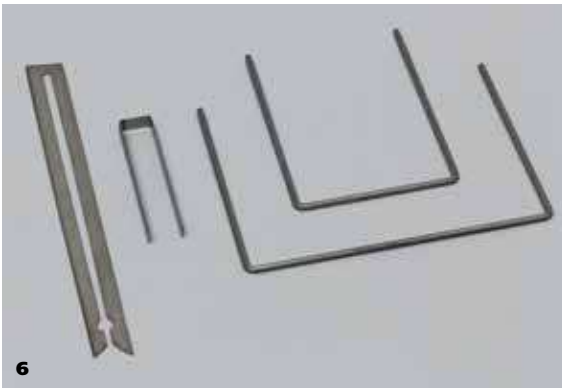

6. ICF Blade Kit

These blades are packaged for the ICF Super Groover.™ If you buy the Super Groover™ and buy these blades, you'll never be caught short on a jobsite again.

KIT INCLUDES: 1 individual blade of each of the following: QS-50, Q-EBX2, Q-EBX4, Q-SB6.

Part Code	Description	Contr Price	Approx Wt
Q-ICFBK	ICF Replacement Blade Kit	\$29.95	1 lb

KIT INCLUDES: Brass plates and 2 thumbscrews.

Part Code	Description	Contr Price	Approx Wt
2-QCRK	Brass Blade Holder Replacement Parts	\$7.95	1/2 lb
Q-SLED6RK	Brass Sled Holder Replacement Parts	\$19.50	1/2 lb

7. Tongue and Groove Blade

For making radius wall cuts in ICF block.

Part Code	Description	Contr Price	Approx Wt
I-TGB	3 pack	\$45.00	1 lb

8. Square Blade

Best for cutting out channels for wiring.

Part Code	Size	Description	Contr Price	Approx Wt
QS-50	1/2" x 3"	3 pack	\$19.00	1 lb

9. Straight Blades

Part Code	Size	Description	Contr Price	Approx Wt
Q-SB2	2"	2 pack	\$20.00	1 lb
Q-SB4	4"	2 pack	\$24.00	1 lb
Q-SB6	6"	2 pack	\$28.00	1 lb

10. Stud Cutter Blade

Part Code	Size	Description	Contr Price	Approx Wt
Q-STUD4	3-1/2" x 3"	2 pack	\$15.00	1 lb
Q-STUD6	5-1/2" x 3"	2 pack	\$17.00	1 lb
Q-STUDK	Both Sizes	2 pack	\$16.00	1 lb

11. Electric Box Cutter Blade

Part Code	Size	Description	Contr Price	Approx Wt
Q-EBX2	2-1/2" x 3"	2 pack	\$13.45	1 lb
Q-EBX4	4-1/2" x 3"	2 pack	\$16.60	1 lb
Q-EBXK	Both Sizes	2 pack	\$15.00	1 lb

12. ICF Taper Block Cutter

Part Code	Description	Contr Price	Approx Wt
I-TBC	Taper Attachment	\$39.95	2 lb

13. Q-CON Conduit Cutter

This special blade is designed to core out the foam wall after the drywall is in place...allows you to drop electrical wires through a clean and smooth channel.

Part Code	Description	Contr Price	Approx Wt
Q-CON	After the Drywall Conduit Blade	\$19.50	1/4 lb



Sled Not Included



14. 6" Groove Sled

Adjustable blade holder accepts blades up to 6" wide.

Part Code	Description	Contr Price	Approx Wt
Q-SLED6	6" Groove Sled	\$96.95	1 lb

15. Straight Edge Attachment

For use with Q-Sled.

Part Code	Description	Contr Price	Approx Wt
Q-SE	Straight Edge Attachment for Sled	\$13.00	1 lb

16. Replacement Blade Holder Parts

Thumbscrews make blade changing easier.

KIT INCLUDES: Brass plates and 2 thumbscrews.

Part Code	Description	Contr Price	Approx Wt
2-QCRK	Brass Blade Holder Replacement Parts	\$7.95	1/2 lb
Q-SLED6RK	Brass Sled Holder Replacement Parts	\$19.50	1/2 lb

17. Round Wire Material

Part Code	Description	Contr Price	Approx Wt
Q-RBM243	24" Round Wire Blade Material 3 pack	\$25.95	1 lb

18. Flat Blade Material

Part Code	Description	Contr Price	Approx Wt
Q-SBM123	12" Flat Blade Material 3 pack	\$18.00	1 lb
Q-SBM128	12" Flat Blade Material 8 pack	\$48.00	1 lb
Q-SBMR12	12' Flat Blade Material Roll	\$66.00	1 lb
Q-SBMR24	24' Flat Blade Material Roll	\$119.95	1 lb

19. Hard Wire Benders

Part Code	Description	Contr Price	Approx Wt
W-HWB	Hard Wire Benders	\$15.75	1 lb

20. Hard Wire Cutter

Features an M2 blade insert hardened to 62Rc for cutting steel and stainless steel wire rope, mild steel rod and hardened round wire for the QC Hot Knife or Super Groover.™

Part Code	Description	Contr Price	Approx Wt
T-HWC63	Hard Wire Cutter	\$57.25	1 lb

21. Step-Up and Down Transformer 120/220V

European converter.

Part Code	Description	Contr Price	Approx Wt
I-TS4033	Transformer Voltage Converter 120/220V	\$29.95	7 lb

PROPER USE OF THE WIND-LOCK® QC HOT KNIFE—SEE WEBSITE



1. How to use the Wind-lock® QC Hot Knife.



4. The versatile blade holders can accept a wide variety of blades and attachments. The QS-50 is shown. 1/2" x 3".



2. The spring loaded on/off trigger offers you instant power.



5. The blade holders can accept a wide variety of blades and attachments. The Q-SLED6 is shown.



3. The dial power control located on the top is for adjustable blade heat control.

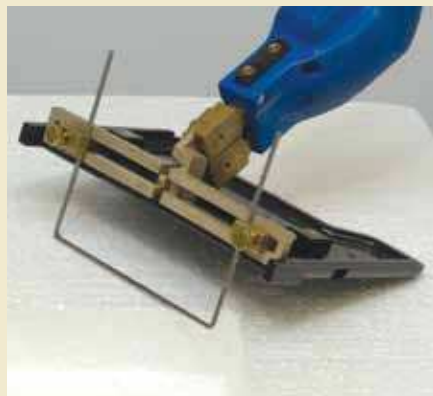

6. The Q-SLED6's adjustable blade depth is used for plunge or scooping cuts. The Q-EBX4 (Electrical Box cutter) is shown.

*Want more cutting power?
Same techniques apply to the
Wind-lock® Super Groover.™*

Always disconnect power before changing blade.

BEND YOUR OWN BLADES

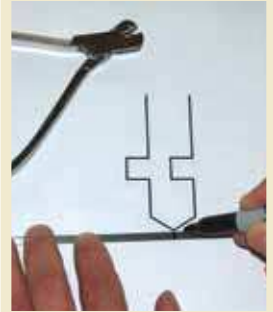

ICF STRUCTURAL SOLUTIONS

SIMPSON

Strong-Tie



- Attach interior partition walls with 1/4-14 #3 drill point screws (sold separately) into ICFVL where needed.
- Use ICFVL to attach ledger to ICF.
- Use ICFVL-W for solid sawn lumber or ICFVL-CW for LVL.

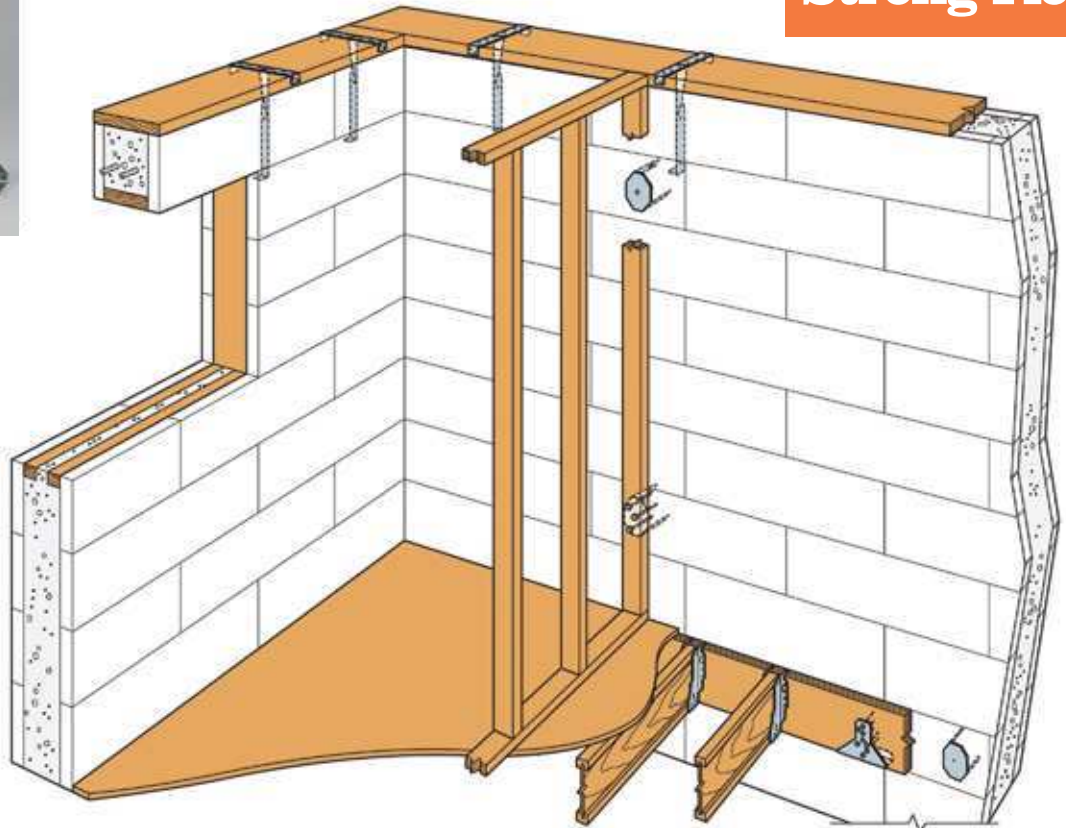

1. Ledger Connectors

Use for rim joist to joist connections. Contact Wind-lock® for current Simpson test data.

Part Code	Qty/Box	Description	Contr Price/Box	Approx Wt/Box
W-ICFVL	15	Steel Ledger	\$128.80	23 lb
W-ICFVLCW	15	Composite Wood	\$128.80	18 lb
W-ICFVLW	15	Wood Ledger	\$128.80	17 lb

2. Heavy-Duty Tek Screws

Part Code	Qty/Box	Size	Description	Contr Price/Box	Approx Wt/Box
UT-MD1147	1000	1/4"-14 x 3/4"	HWH Med-Duty #3 Drill	CALL	13 lb
UTMD1147-PK	100	1/4"-14 x 3/4"	HWH Med-Duty #3 Drill	CALL	2 lb
W-ICFD3	120	1/4"-28 x 3"	HWH Hvy-Duty #5 Drill	CALL	5 lb



The ICFVL Ledger Connector System is engineered to solve the challenges of mounting wood or steel ledgers to insulated concrete form (ICF) walls. Simpson's new ICF component of the system, the ICFVL, is designed to provide both vertical and lateral, in-plane performance. The system is still quick, versatile and easy to use but now provides so much more! There are many benefits over traditional anchor bolting, including better on center spacing in most cases, faster installation and no protrusions.

Simpson's ICFVL is made from galvanized, 14 gauge steel. The embedded legs are embossed for additional stiffness and the hole allows for concrete to flow through and around the connector. The exposed flange on the face of the ICF provides a structural surface for mounting either a wood or steel ledger.

MATERIAL: ICFVL—14 gauge; ICFVL-CW and ICFVL-W—16 gauge

FINISH: Galvanized

INSTALLATION: ICFVL in ICF

- Snap a chalk line for the bottom of the ledger.
- Mark required on center spacing.
- Use ICFVL to mark kerfs locations.
- Cut kerfs as marked.
- Insert ICFVL flush to the face of the ICF.
- Place concrete.

Wood Ledger Attachment – ICFVL-W or -CW

- Slip appropriate ledger connector underneath the ledger.
- Install the eight ICF-D3 screws partially into the ledger.
- Position the ledger level to the chalk line and drive the screws through the wood and into the ICFVL.

Steel Ledger Attachment

- Position the ledger level to the chalk line and against the ICFVL.
- Attach with four 1/4-14x3/4", #3 drill point screws (not provided).
- All screws should be located at least 1/2" from the edge of the ICFVL.
- Space screws evenly.

CODES: See page 12 for Code Listing Key Chart.

WARNING:
Industry studies show that hardened fasteners can experience performance problems in wet environments. Accordingly, use this product in dry environments only.

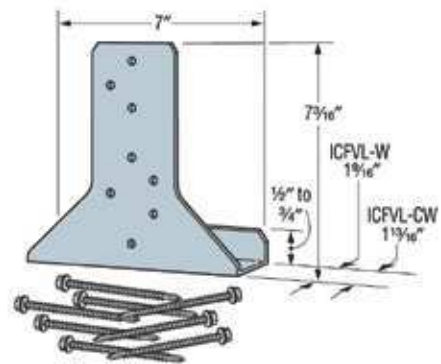
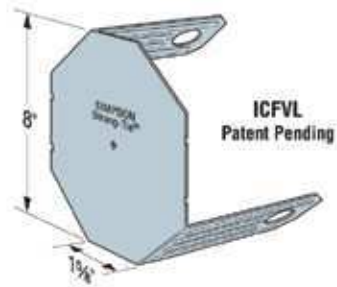

ICFVL-W and ICFVL-W

Ledger Type	Fasteners	Allowable Load (lbs)	
		Download (100/115/125)	Lateral F ₁ (133/160)
Wood	8-ICF D3	1940	1905
Steel	4 - 1/4x3/4"	1660	1525

1. Fasteners for wood ledger (D3) are provided with the part and fasteners for steel ledger are not provided.
2. Loads apply to ICF foam thicknesses of 2 1/2" or less. Contact Simpson for allowable loads on thicker walls.
3. Alternately, #14 x 3/4" fastener may be used.
4. Tabulated loads may not be increased.

5. Concrete F_c = 2500 psi minimum.
6. When combining download and lateral loads, Designer shall evaluate as follows:
Design Download/Allowable Download + Design Lateral Load/Allowable Lateral Load.

These tables address vertical load applications only.

Ledger Type	Connector Type	ICFVL SPACING TO REPLACE ANCHOR BOLTS (in.) ^{1,2,3}																Code Ref.
		1/2" Dia. Anchors at				3/8" Dia. Anchors at				(2)-3/8" Dia. Anchors at				1/4" Dia. Anchors at				
		12" O.C.	24" O.C.	36" O.C.	48" O.C.	12" O.C.	24" O.C.	36" O.C.	48" O.C.	12" O.C.	24" O.C.	36" O.C.	48" O.C.	12" O.C.	24" O.C.	36" O.C.	48" O.C.	
WOOD LEDGERS																		
DF/SP/SPF	ICFVL w/ ICFVL-W	48	48	48	48	43	48	48	48	21	42	48	48	39	48	48	48	160
LVL	ICFVL w/ ICFVL-CW	48	48	48	48	43	48	48	48	21	42	48	48	39	48	48	48	
STEEL LEDGERS																		
68 mils (0.068")	ICFVL	11	22	33	44	9	18	27	36	—	—	—	—	—	—	—	—	160
54 mils (0.054")	ICFVL	15	30	45	48	12	24	36	48	—	—	—	—	—	—	—	—	

1. The Designer may specify different spacing based on the load requirements.
2. Spacings are based on perpendicular to grain capacity of bolt in wood ledger compared to tested value of ICFVL.
3. See F-ICFVL Rier for additional connection details.
4. For steel ledgers, the 68 mil ledger spacing is closer than the 54 mil ledger because the calculated load of a bolt is higher in a thicker piece of steel.
5. Steel ledger values are based on steel. F_u = 60 ksi.

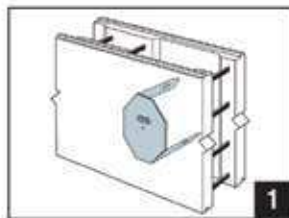

ICFVL

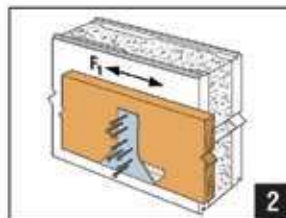

Typical Wood Ledger Installation with ICFVL and ICFVL-W



MISINSTALLATION!

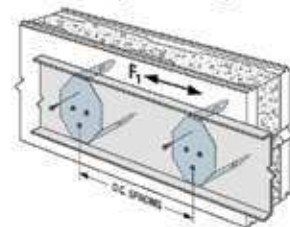

Requires 4 screws at each location. Table provides on center spacing.

3. Simpson Titen HD

The Simpson Strong-Tie® Titen HD Screw Anchor can be used as a direct replacement for code prescribed cast-in-place sill anchor bolts. The Titen HD is a patented, high-strength screw anchor for concrete. The self-undercutting, non-expansion characteristics of the Titen HD makes it the ideal anchor for structural applications for ICF construction. The proprietary cutting teeth enable the Titen HD to be installed in one eighth of the time and after the ICF wall has been poured. The anchor can be installed with a standard ANSI tolerance drill bit. Recommended for permanent dry, interior non-corrosive environments.



Part Code	Qty/Box	Description	List/Box	Approx Wt/Box
THD-50600H	20	1/2" x 6", Drill 1/2"	CALL	10 lb
THD-62600H	10	5/8" x 6", Drill 5/8"	CALL	7 lb
THD-62612H	10	5/8" x 6-1/2", Drill 5/8"	CALL	8 lb

Titen HD Technical Data

Connection Method of 1/2" Anchor	Embed Depth	Min. End Distance	Capacity of Connection at 1-3/4" Edge Distance (lbs)								
			(133)				(160)				
			Tension	Shear//	Shear	O.C. Spacing	Tension	Shear//	Shear	O.C. Spacing	
Code Prescribed Method											
Anchor to Concrete	7"	5"	740	970	970	6'	740	970	970	6'	
Anchor to 2x Sill Plate 2	7"	5"	925	880	465	6'	925	1055	560	6'	
Simpson 1/2" Titen HD Anchor											
THD to Concrete 1, 3	4-1/2"	8"	1155	2600	725	6'	1155	2600	725	6'	

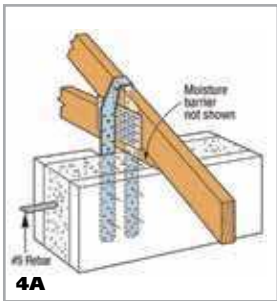

4. Simpson Truss Connectors

Ideal for ICF construction, these Simpson connectors are hurricane code-approved for securely attaching roof trusses and rafters at the critical transition of wall to roof. Call Wind-lock® for special orders.

H16S Seismic Tiedown Technical Data

Ga	Fasteners to Rafter or Truss	Fasteners to Concrete	Allowable Loads DF/SP (133/160)			Allowable Loads SPF (133/160)		
			Uplift	F1	F2	Uplift	F1	F2
18	2-10d x 1-1/2"	6-1/4" x 1-3/4" Titen	1470	—	—	1265	—	—

Ordering Information

Part Code	Qty/Box	Description	List/Box	Approx Wt/Box
A W-H16S	50	H Seismic Tiedown	CALL	24 lb

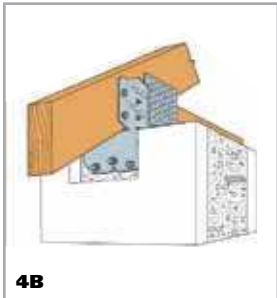

HM9 Seismic Tiedown Technical Data

Ga	Fasteners to Rafter or Truss	Fasteners to Concrete	Allowable Loads DF/SP (133/160)			Allowable Loads SPF (133/160)		
			Uplift	F1	F2	Uplift	F1	F2
18	4-SDS 1/4" x 1-1/2"	5-1/4" x 1-3/4" Titen	595	425	200	595	425	200

Ordering Information

Part Code	Qty/Box	Description	List/Box	Approx Wt/Box
B W-HM9KT	20	H Seismic Tiedown	CALL	12 lb

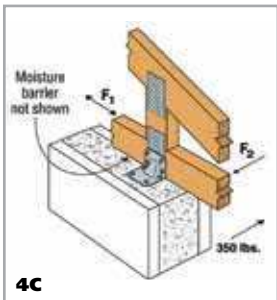

HGAM10 Hurricane Gusset Angle Technical Data

Ga	Fasteners to Rafter or Truss	Fasteners to Concrete	Allowable Loads DF/SP (133/160)			Allowable Loads SPF (133/160)		
			Uplift	F1	F2	Uplift	F1	F2
14	4-SDS 1/4" x 1-1/2"	4-1/4" x 1-3/4" Titen	850	1005	1105	850	870	815

Ordering Information

Part Code	Qty/Box	Description	List/Box	Approx Wt/Box
C W-HGAM10KT	10	Hurricane Gusset Angle	CALL	5 lb

Wire Tie Not Included



1



3



2



3

NEW!

ICF FASTENERS

1. Buck Plates

The BUK-302 series is used in conjunction with Foam2Foam® to secure traditional wood bucks to ICF form openings. Available preassembled with wood/lite metal screws to save field application time.

Engineered Features

- 1-3/4" diameter
- Made of high-grade polypropylene plastic
- Unique design allows plate to flatten out in application
- Large ribs stiffen plate, limit deflection
- 16 keyholes allow for mechanical locking of base coat
- Available assembled or non-assembled

Not recommended for use within standard PB EIFS.

Part Code	Insulation Qty/Box	Screw Thickness	Contr Size	Approx Price	Wt
NS BUK-302	1000 Plates	NA	NA	CALL	6 lb
BUK-3WLM1	1000 Plates with Screws	3/4"	#7 x 1-5/8"	CALL	13 lb
BUK-3WLM2	1000 Plates with Screws	1"	#8 x 2"	CALL	15 lb
BUK-3WLM3	1000 Plates with Screws	1-1/2"	#8 x 2-1/2"	CALL	17 lb
BUK-3WLM4	1000 Plates with Screws	2"	#8 x 3"	CALL	19 lb
BUK-3WLM5	1000 Plates with Screws	3"	#8 x 4"	CALL	21 lb

NS=Not shown.

*Save time and money!
Order pre-assembled fasteners.*



Stock to Dock Shipping Guarantee

Products highlighted in yellow are guaranteed to ship within 24 hours or freight costs are **FREE!** Larger orders may require additional lead times. Call for details.

2. Wind-Devil® 2 Fasteners

The industry-leading, two-inch diameter Wind-Devil® 2 is by far the most popular and technologically advanced EPS mechanical fastening system on the market. The patented "bullseye" closure arms allow easy, efficient backing out of any screw, saving time and money.

Part Code	Insulation Qty/Box	Thickness	Approx Screw Size	Wt/Box
NS WD-2PLATE	1000 Plates	10 lb	NA	10 lb
NS WD2-PK	500 Plates	5 lb	NA	5 lb
WLMT-1	1000 Plates	1"	#7 x 1-5/8"	16 lb
WLMT-2	1000 Plates	1-1/2"	#8 x 2"	19 lb
WLMT-3	1000 Plates	2"	#8 x 2-1/2"	21 lb
WLMT-4	1000 Plates	2-1/2"	#8 x 3"	22 lb
WLMT-5	1000 Plates	3"	#8 x 4"	25 lb
WLMT-7	500 Plates	3-1/2"–4-1/2"	#10 x 5"	20 lb
WLMT-8	500 Plates	5"–5-1/2"	#10 x 6"	22 lb

NS=Not shown.

3. tieKey® NEW!

The tieKey® anchor is an easy to install, cast-in-place, adjustable masonry tie anchor that is embedded into the concrete wall which is formed by the insulating concrete form. This product is designed to provide the strength and security required when installing brick or stone veneer finishes. The tieKey® anchor is part one of a two-part system; the masonry anchor and any standard wire tie (not included). The masonry anchor is inserted through the ICF as the wall is formed, and reinforced as concrete is placed. The wire tie is installed as the masonry facing is applied. This system can accommodate construction tolerances and allow for differential movement for a variety of brick finishes and is available in a hot-dipped galvanized finish.

Part Code	Qty/Box	Contr Price/Box	Approx Wt/Box
W-BTK	200 pieces/box	\$300.00	32 lbs



SIP

1. SIP/ICF Through-Wall Screws

Fast, one step installation for increased holding power. Fasteners engineered for Structural Insulated Panels (SIP) and ICF through-wall connections. FREE drive bit in every pack. Consult system manufacturer for specific requirements. Mix and match for column discount.

Must order in box quantities.

Part Code	Qty/Box	Description	Contr Price/Box	Approx Wt/Box
W-SIP004	250	4-1/2" SIP Fastener	\$62.50	10 lb
W-SIP005	250	5" SIP Fastener	\$87.50	12 lb
W-SIP006	250	6" SIP Fastener	\$110.00	14 lb
W-SIP007	250	7" SIP Fastener	\$135.00	16 lb
W-SIP008	250	8" SIP Fastener	\$157.50	18 lb
W-SIP009	250	9" SIP Fastener	\$175.00	20 lb
W-SIP010	250	10" SIP Fastener	\$185.00	22 lb
W-SIP011	250	11" SIP Fastener	\$202.50	24 lb
W-SIP012	250	12" SIP Fastener	\$217.50	26 lb
W-SIP013	250	13" SIP Fastener	\$232.50	28 lb
W-SIP014	250	14" SIP Fastener	\$280.00	30 lb
W-SIP015	250	15" SIP Fastener	\$312.50	32 lb
W-SIP016	250	16" SIP Fastener	\$375.00	34 lb

SIP Screwdriver Bits

Part Code	Description	Contr Price	Approx Wt
NS W-SIPBIT	SIP Fastener Star Drive Bit	\$4.25	1 lb
NS M-PBT303	#3 T30 Star Drive 6 pack	\$18.75	1 lb

NS=Not shown.

2. FROTH-PAK® 160 Slow Rise Foam

Excellent for blind filling panel connection.

KIT INCLUDES: 1 ISO (A) cylinder; 1 Polyol (B) cylinder, 9 ft. gun hose assembly, 6 cone white spray nozzles, 4 GG white spray nozzles, 1 petroleum jelly packet and instruction sheet.

Part Code	Description	Contr Price	Approx Wt
W-FP160SR	Slow Rise Foam Kit	CALL	39 lb

3. Froth-Pak® 180

200 Board Feet/16.6 Cubic Feet

KIT INCLUDES: Iso (A) cylinder, Polyol (B) cylinder, 6 cone spray nozzles, 4 GG spray nozzles, 9-ft gun hose assembly, petroleum jelly packet.

Part Code	Description	Contr Price	Approx Wt
W-FRPK180	Sealant Kit	CALL	39 lb
NS W-FP200CA	Insulation Kit, Class A	CALL	39 lb

NS=Not shown.

To view our complete library of DOW instructional videos, go to WIND-LOCK.COM

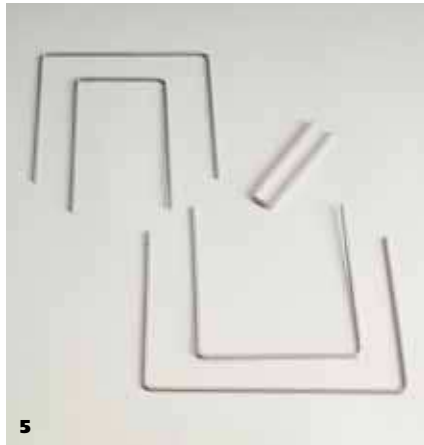

SIP ADHESIVE & FOAM CUTTING

1. W-F2F® Foam and Cleaner*

Part Code	Description	Contr Price	Approx Wt
W-F2F24	Wind-lock Foam2Foam Case	CALL	22 lb
NS W-PGCS	F2F Gun Cleaner 12 oz Case	CALL	13 lb

*For more information on F2F, please see pg. 58, 59.

NS=Not shown.

2. Great Stuff™ Pro Gaps & Cracks

For filling and air-sealing small holes, gaps and cracks, also acts as a fireblocking material to help prevent the spread of fire and smoke.

Part Code	Description	Contr Price	Approx Wt
NS W-GSGC20	Gun Dispenser Case of 12, 20 oz cans	CALL	25 lb
W-GSGC26	Gun Dispenser Case of 12, 26 oz cans	CALL	28 lb
NS W-GSGCRS20	Reusable Straw Dispenser Case of 12, 20 oz cans	CALL	25 lb
NS W-GSGCRS26	Reusable Straw Dispenser Case of 12, 26 oz cans	CALL	28 lb

NS=Not shown.

3. ICF Super Groover™

Consistent utility service channels and grooves can be cut with one fast, clean pass. The cuts range from 1/2" to 6" wide, with virtually unlimited depth. The Super Groover™ comes standard 110 volt. **KIT INCLUDES:** The Super Groover,™ 6" sled, 4" straight blade, 1/2" x 3" square blade, single and double electrical box cutter blades, 2 pieces of 12" flat blade material, and Gatemouth Jr. bag.

- Variable temperature control
- Blade in front for inside corners
- Detachable sled allows straight blade use

Part Code	Description	Contr Price	Approx Wt
I-ICFSG	Super Groover	\$499.95	10 lb
NS I-ICFSGKIT	Super Groover Kit	\$540.95	12 lb

NS=Not shown.

4. SIP Kit

Great for cutting out studs.

KIT INCLUDES: 2-QC Hot Knife, 6" sled, 1/2" x 3" square blade, 4" straight blade, 4" and 6" stud cutter blades.

Part Code	Description	Contr Price	Approx Wt
2-SIPKIT	Structural Insulated Panel Tool Kit	\$351.65	4 lb
NS 2-BISIPKIT	Structural Insulated Panel Tool Kit and Gatemouth Jr. Bag	\$381.65	5 lb

NS=Not shown.

5. SIP Blade Replacement Kit

KIT INCLUDES: QS-50, Q-STUDK, Q-EBXK.

Part Code	Description	Contr Price	Approx Wt
Q-SIPBK	Replacement Blades for SIP Kit	\$29.95	1 lb



ICF MOISTURE CONTROL

1. Window/Door Membrane Flashing

A secondary weather barrier for use around windows, doors or any structural opening. Adheres to polystyrene when used with W-STP primer.

Part Code	Qty/Box	Size	Description	Contr Price/Pc	Approx Wt/Box
W-PWDT4	12	4" x 100' x 30 mil	Flashing Tape	\$32.50	99 lb
W-PWDT6	8	6" x 100' x 30 mil	Flashing Tape	\$50.65	96 lb
W-PWDT9	4	9" x 100' x 30 mil	Flashing Tape	\$77.95	80 lb
W-PWDT12	4	12" x 100' x 30 mil	Flashing Tape	\$100.95	98 lb

2. Plate Liner

The 1/4" economy plate liner is a peel-and-stick, closed-cell-foam liner that stops air and moisture infiltration. Use it at the floor, top of the wall and window bucks. Place on the buck system before the concrete is poured to prevent the concrete from coming in contact with the wood. This creates a joint that prevents air and moisture from leaking in at that critical construction joint.

Part Code	Qty/Box	Size	Description	Contr Price/Pc	Approx Wt/Box
W-PL35	7	3-1/2" x 25'	Plate Liner	\$23.25	15 lb
W-PL55	4	5-1/2" x 25'	Plate Liner 1/4" Foam	\$55.25	25 lb

3. Sill Sealer

The 3/8" thick premium grade, peel-and-stick, closed-cell-foam seals off voids and irregularities between the top of foundations and sill plates. Use it at the floor, top of the wall, and window bucks. Place on the buck system before the concrete is poured to prevent the concrete from coming in contact with the wood. This creates a joint that prevents air and moisture from leaking in at that critical construction joint.

Part Code	Qty/Box	Size	Description	Contr Price/Pc	Approx Wt/Box
W-PSS35	7	3-1/2" x 25' x 3/8"	Sill Sealer	\$31.95	12 lb
W-PSS55	4	5-1/2" x 25' x 3/8"	Sill Sealer	\$44.95	19 lb

4. Transition Wrap

The transition wrap is great for difficult to finish areas, such as parapets, or at the transition between grade and the first course of cladding. The protective membrane is a sticky back that adheres to polystyrene when used with the W-STP primer. The front has the appearance of a smooth, trowel-applied sand stucco finish and can be painted to match the existing siding.

Part Code	Qty/Box	Size	Description	Contr Price/Pc	Approx Wt/Box
W-PIW12	4	12" x 50'	Transition Wrap	\$239.35	64 lb

5. Water Based Primer

Recommended to be used with flashings, wraps and liners. To obtain manufacturer's recommended coverage per gallon, call 1-800-872-5625.

Part Code	Qty/Box	Size	Description	Contr Price	Approx Wt/Box
W-STP	4	1 gallon	Mfg Water Based Primer Trans Wrap	\$63.75	9 lb



INSTALLATION ESSENTIALS

1. Rebar Bender and Cutter

Shear-cut up to #5, 5/8" grade 60 Rebar and bend to 180°.

Part Code	Description	Contr Price	Approx Wt
W-RCB	Rebar Cutter/Bender	\$349.95	39 lb

2. Universal Stirrup Bender

Designed for field fabrication of stirrups, for rebar lintels #3–3/8". The multi-function stirrup bender shapes 2-1/4" and 3/4" inside hook diameters.

Part Code	Description	Contr Price	Approx Wt
W-XTC	Commercial and Residential Stirrup Bender	\$375.00	12 lb

3. ICF Deck-Chairs

The solid stable base has two secure rebar placement cradles. One at 1/2" high and the other at 3/4" high for accurately setting the height of the rebar within the structural beam of the concrete deck.

Part Code	Qty/Box	Description	Contr Price	Approx Wt/Box
A I-CDC15	100	Universal Concrete Deck-Chairs	\$45.00	10 lb
B I-IDCU	200	Universal Rebar Holder #3–#8	\$190.00	10 lb

4. Boss® Biggies Industrial Wipes

These dual-sided industrial wipes clean paint, adhesives, oil and more from hands, tools and surfaces.

Part Code	Description	Size	Contr Price
W-BW	Dual-sided abrasive wipes 80 wipes per container	8" x 12"	\$25.95

Cut Protection



5



6



7

NEW!



8

5. Ansell Cut Protection Glove

Combining comfort plus the ultimate in cut protection and dexterity—all in one glove—this is the construction glove to be wearing when handling rough, sharp or jagged materials.

Part Code	Description	Size	Contr Price
W-KEVGMD	Blue Kevlar with Stainless Steel Cut Resistant Gloves	Medium	\$20.95
W-KEVGLG	Blue Kevlar with Stainless Steel Cut Resistant Gloves	Large	\$20.95

6. Concrete Slump Kit

KIT INCLUDES: Slump cone, concrete scoop and tamping rod.

Part Code	Description	Contr Price	Approx Wt
W-SCK	Concrete Slump Kit	\$70.95	5 lb

7. ICF Wallibrator NEW!

A must for proper concrete consolidation, this hand-held ICF wall vibrator attaches to any electric or cordless drill. Combining a high-speed, low-impact vibration, the Wallibrator insures good consolidation of concrete with one pass. Sizing in at just under 3 pounds and a length of 7 inches, this tool is lighter and more compact than most other traditional external vibrators. Drill not included.

Part Code	Contr Price	Approx Wt
W-IWVB	\$125.00	5 lb

8. Multivibe

The “Hummer Flex Hose System” is a portable, gas powered, internal vibrator for ICF construction. The Hummer has a durable 1" x 12" vibrating head, with a standard 8' long hose. It has a four stroke Honda engine for low maintenance and long-term reliability. Included with the Hummer is a comfortable shoulder strap for those large ICF jobs.

Part Code	Description	Contr Price	Approx Wt
I-HVHE	Portable Gas-Powered Concrete Vibrator	\$1,675.00	18 lb



9



10



11



12

9. Zip Tie Installation Tool

Part Code	Contr Price	Approx Wt
Q-L300C	\$49.00	1 lb

10. Nylon Zip Ties

Nylon Zip ties are used to reinforce Insulating Concrete Forms (ICF) at corners and T-wall intersections and to secure bracing to the forms. They come in a variety of lengths. Made of 100% nylon, they are alkyl and rust resistant (will not stain the forms).

Part Code	Size	Description	Contr Price	Approx Wt
Q-ZIP8	8" Long	120 lbs Tensile Strength, 100 pack	\$15.65	1lb
Q-ZIP24	24" Long	175 lbs Tensile Strength, 50 pack	\$19.65	1 lb
Q-ZIP36	36" Long	175 lbs Tensile Strength, 50 pack	\$22.35	2 lb

11. Filament Tape

Used for reinforcing form construction around windows, doors, end walls and corners.

Part Code	Qty/Box	Size	Contr Price/Pc	Approx Wt/Box
W-FT1	36	1" Wide Filament Tape	\$4.00/Roll	14 lb
W-FT2	24	2" Wide Filament Tape	\$7.35/Roll	28 lb

12. Clear Tape

Keep the tops of your forms clean during your next concrete pour with our 2" or extra wide 4" clear tape. Save labor and protect the important interlocks on the top of your insulated concrete form (ICF).

Part Code	Description	Contr Price	Approx Wt
W-CPT4	4" Wide Clear Protection Tape	\$4.95	1 lb



13



14



13



15

13. PVC Electrical Boxes

Commercial grade boxes let you pull wires through your future ICF walls. These code-approved electrical boxes are designed for receiving PVC conduit placed into ICF walls prior to the concrete pour. The boxes are strong, secure and can hold up to the rigors of concrete placement.

Part Code	Description	Contr Price	Approx Wt
NS I-ICESGL	Single Gang Electrical Box	CALL	1 lb
I-ICEDBL	Double Gang Electrical Box	CALL	1 lb
NS I-ICETPL	Triple Gang Electrical Box	CALL	1 lb

For foam systems that are 2"-2 1/4" width, there is a spacer clip to fill the gap, available at no additional cost.

NS=Not shown.

14. Grappler™

Product Applications

- Decorative Wall Hangings
- Bathroom Accessories
- Smoke Detectors
- Bulletin Boards
- Picture Frames
- Curtain Rods
- Doorbells
- Brackets

The answer to lightweight accessory attachment on ICF walls. Simply push into the foam block before the drywall is installed and hang objects by nailing 15 gauge finish nails, or screwing through the drywall into the Grappler™.

Part Code	Qty/Box	Description	Contr Price/Box	Approx Wt/Box
I-GRP48	90	Grappler 90 pack	CALL	19 lb

15. Anchor Tunnel

The 6" diameter Anchor Tunnel securely holds your 1/2" bolt in place, allowing the concrete to flow to the exterior face of block producing a solid attachment point between the rim joist and the concrete wall.

Part Code	Description	Contr Price	Approx Wt
I-AT	6" Diameter Polyethylene Anchor Tunnel	CALL	1 lb
I-AT50	6" Diameter Polyethylene Anchor Tunnel 50 pack	CALL	18 lb
I-ATW	Spanner Wrench for Installing the Anchor Tunnel	CALL	1 lb



NEW!



EXCLUSIVE PRODUCT



ICF FORM FABRICATING

1. BowCutters and Accessories

Free form cutters.

Part Code	Description	Contr Price	Approx Wt
I-BC12	12" BowCutter with Power Box	CALL	9 lb
I-BC24	24" BowCutter Only	CALL	12 lb
I-BC48	48" BowCutter Only	CALL	19 lb
I-MBC24	24" BowCutter with Magnum	CALL	19 lb
I-MBC48	48" BowCutter with Magnum	CALL	25 lb

2. Hot Wire Kit

Everything you need to build your own 4' hot wire machine.

KIT INCLUDES: magnum, gator cord, 2 insulators, spring and 100' roll of Nichrome wire.

Part Code	Description	Contr Price	Approx Wt
W-DHW100	Hot Wire Kit	CALL	13 lb

Replacement Accessories

W-MAGC	Magnum Controller Only	CALL	12 lb
W-DGC	4' Gator Cord	CALL	1 lb
I-DHW100	100' 23 ga Nichrome 80 Wire	CALL	1 lb

3. Tajima G-Saw **NEW!**

The Tajima G-Saw cuts through ICFs, PVC, rigid foam and plastic ties faster, straighter and with less mess than other saws on the market. This handy folding saw feature aggressive push-pull cutting action and razor-sharp, triple-edge teeth hardened for long life. Positive blade lock with convenient thumb release. Comfortable, sure-grip handle. 17 teeth per inch.

Part Code	Description	Contr Price/Box	Approx Wt/Box
W-TJGSAW	Tajima ICF G-Saw	\$28.99	1 lb
W-TJGBLADE	Tajima ICF G-Saw Replacement Blade	\$13.99	1 lb

4. UGZ® II EverRasp

Engineered better! EPS doesn't stand a chance!

The UGZ® II EverRasp is the Professional ICF contractors' preferred choice when it comes to blasting through the toughest rasping jobs at critical tops of walls. Also used for smoothing bulges and preparing the foam surface for stucco finishing.

Part Code	Size	Description	Contr Price	Approx Wt
I-IIUGZ2	2" x 14"	SS Rasp 12-14 Grit	\$44.75	2 lb
I-IIUGZ4	4" x 14"	SS Rasp 12-14 Grit	\$64.75	2 lb
I-IIUGZ6	6" x 14"	SS Rasp 12-14 Grit	\$74.75	3 lb
I-IIUGZ8	8" x 14"	SS Rasp 12-14 Grit	\$84.75	3 lb
I-IIUGZK26	2" and 6" x 14"	SS Rasp Kit	\$119.75	5 lb
I-IIUGZK46	4" and 6" x 14"	SS Rasp Kit	\$139.75	5 lb

To see our full selection of rasps, call for our EIFS catalog or visit www.wind-lock.com

5. Insul-Knife™

Insul-Knife™ is one of those time-saving tools that you will wonder how you ever lived without. It is perfect for easily cutting all type of insulations including: eps foam, fiberglass, sponge foam and cotton fiber. It is an excellent tool for trimming unwanted excess foam insulation after it expands and cures.

Part Code	Description	Contr Price
W-INSULKIT	Multipurpose Insulation Kit (Knife and Sharpener)	\$42.95
W-INSULS	Multipurpose Insulation Knife Sharpener	\$10.99

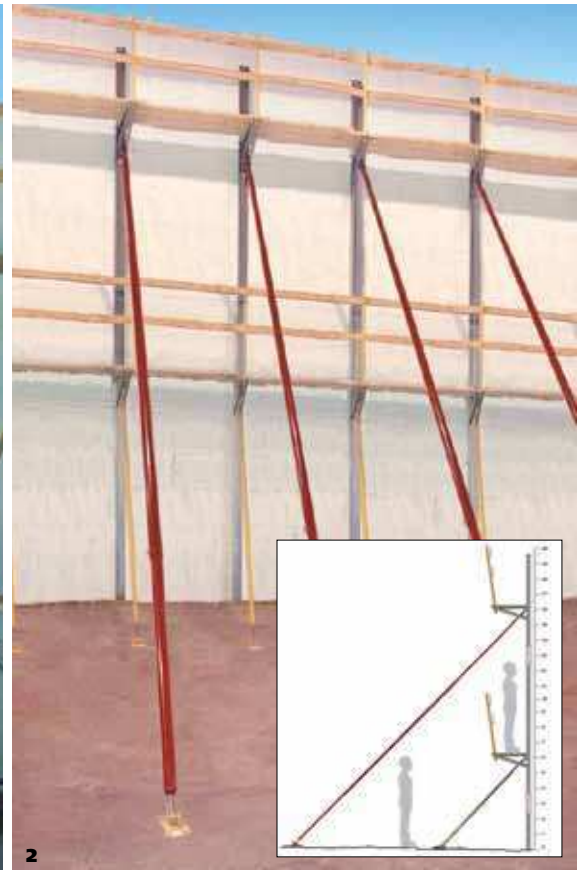

ICF BRACING SOLUTIONS BY TAPCO



Mono-Brace comes in one piece, making it easy to move.



Locking toggle pins make for quick, easy adjustment and installation.

MONO-BRACE™ ALL-IN-ONE BRACING SYSTEM

The Mono-Brace™ and Tall Wall are interchangeable products designed for ICF wall construction.

FEATURES AND BENEFITS

One Piece, Self-Contained Package

No lost parts or delays in installation. Saves space and is easy to move.

Quick Installation

Locking toggle pins make for quick, easy adjustment and installation.

Built to Last

Galvanized and heavy-duty powder-coated steel for long life.

Fully Adjustable

Micro and macro adjustment make installation accurate and efficient. Adjustable platform.

Integrates with Buck Scaffolding

Works on high wall with readily available cost-effective buck scaffolding.

1. Mono-Brace™

Mono-Brace™ is easy to store, transport and use. The bracing system is self-contained and all the parts are attached to the frame. No assembly is required. Replacement parts available.

Part Code	Description	Dimensions	Contr Price	Approx Wt
W-BR8	8' Telescopic Foldaway ICF Bracing System w/safety rail bracket	8' x 5" x 2.75"	CALL	58 lb
W-BR9	9' Telescopic Foldaway ICF Bracing System w/safety rail bracket	9' x 5" x 2.75"	CALL	63 lb
W-BR10	10' Telescopic Foldaway ICF Bracing System w/safety rail bracket	10' x 5" x 2.75"	CALL	65 lb
W-BR12	12' Telescopic Foldaway ICF Bracing System w/safety rail bracket	12' x 5" x 2.75"	CALL	72 lb

Platform rating 50 pounds per square foot, handrail rated for a 200-pound point load as required by OSHA. Brace rated 10 pounds per square foot lateral wind load.

2. Tall Wall Leg Kit

Tapco Tall Wall Leg Kit is designed for use in ICF block wall construction from 12 ft to 24 ft and is compatible with Tapco Mono-Brace™ products. Included are all the necessary components to install the wall brace.

Part Code	Description	Dimensions	Contr Price	Approx Wt
W-BRTWL	Kit includes 4 sections of telescoping heavy wall tube, 2 end screws, 3 gravity pins, 1 foot plate.	14' x 3' x 5.5"	CALL	145 lb



3



4



Jamb Jack™ includes a heavy-duty steel adjustment screw that allows for minute adjustments.

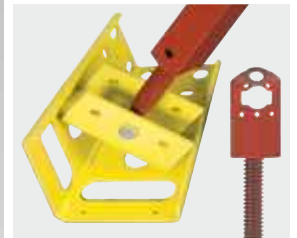

Professional Jamb Jack™ accessories include corner plate and panel adaptor.



Locking safety pins and adjustment tool make for quick and easy installation and adjustment for both the professional and residential Jamb Jack™ products.

JAMB JACK™ REUSABLE WINDOW AND DOOR BRACING

Available for both professional and residential use, the Jamb Jack™ Window & Door Bracing Kit is durable, easy to use and easily adjustable.

FEATURES AND BENEFITS

Quick Installation

Up to 90% less setup time required.

Longlasting

Made of reusable, heavy-duty powder-coated steel.

Fully Adjustable

Micro and macro adjustments.

Easy to Use

Fits most window, door and standard openings.

Versatile

Easily adapted to other form systems.

3. Professional Jamb Jack™ Kit

Part Code	Description	Adjustment Capabilities	Contr Price	Load Capacity	Approx Wt
W-JJS	Jamb Jack Kit (short)	36"–57"	CALL	3,000 lb	19 lb
W-JJM	Jamb Jack Kit (medium)	53"–80"	CALL	3,000 lb	22.5 lb
W-JJL	Jamb Jack Kit (long)	72"–108"	CALL	3,000 lb	26 lb
W-JJCP	Jamb Jack Corner Plate	Accessory	CALL	—	4.1 lb
W-JJPA	Jamb Jack Panel Adaptor	Accessory	CALL	—	.4 lb
W-JJAT	Jamb Jack Adjustment Tool	Accessory	CALL	—	.2 lb

4. Residential Jamb Jack™ Kit

Part Code	Description	Adjustment Capabilities	Contr Price	Load Capacity	Approx Wt
W-JJRS	Jamb Jack Kit (short)	40"–64"	CALL	2,000 lb	24 lb
W-JJRL	Jamb Jack Kit (long)	62"–108"	CALL	2,000 lb	26 lb

5. Adjustment Tool

Part Code	Description	Contr Price	Approx Wt
NS W-CBR16	Wrench, Leg Fine Adjustment Tool	CALL	1 lb

NS=Not shown.



Jamb Jack™ quickly and easily fits into virtually any size window.

WEATHERIZATION CONSTRUCTION SOLUTIONS

Construction trade professionals trust proven products like Froth-Pak,[®] Great Stuff[™] Pro, Insta-Stik,[™] EnerFoam[™] and more. Experienced professionals also know that the Dow[®] Chemical Company manufactures a high-quality product to meet any need, backed by a global presence and decades of product development experience. Wind-lock is committed to making unsurpassed product lines like this available to our customers, and we're proud to be a Dow[®] Red Diamond distributor.

80
80
81
82
82
83
84

ENERFOAM[™]

GREAT STUFF[™] PRO

FOAM GUNS

FROTH-PAK[®]

INSTA-STIK[™]

WEATHERMATE[™]

INSTALLATION ESSENTIALS



GREAT STUFF[™] PRO
PAGE 80



FROTH-PAK[®]
PAGE 82



**WEATHERMATE
HOUSEWRAP[™]**
PAGE 83



CI-LOCK FASTENER
PAGE 84

SUPPORT WHEN YOU NEED IT

For more than 20 years, Wind-lock has been focused on the right people coming through at the right time for our customers. That means expert advice available through our dedicated team and no hassle support that helps simplify your job. It also means reliability, an emphasis on helping you maximize productivity and a commitment to partnership.





1



2



3



4



5

DOW® ADHESIVES AND SEALANTS

SIGNATURE
PRODUCT



Great Stuff™ Pro available with reusable straw.



Industry-leading valve allows for multiple uses.



Now offering Great Stuff™ consumer line of sealants and insulation. Call for details.

1. EnerFoam™ Professional Foam Sealant

EnerFoam™ is ideal for applications including insulation, hole and crack filling, blocking insects and acoustical sealing (STC 69).

Part Code	Description	Contr Price	Approx Wt
NS W-EF24RS24	Reusable Straw Foam Case of 12, 24 oz cans	CALL	27 lb
NS W-EF2524	Gun Foam Case of 12, 24 oz cans	CALL	27 lb
W-EF4230	Gun Foam Case of 12, 30 oz cans	CALL	32 lb

NS=Not shown.

2. Great Stuff™ Pro Gaps & Cracks

For filling and air-sealing small holes, gaps and cracks, also acts as a fireblocking material to help prevent the spread of fire and smoke.

Part Code	Description	Contr Price	Approx Wt
NS W-GSGC24	Gun Foam Case of 12, 24 oz cans	CALL	29 lb
W-GSGC30	Gun Foam Case of 12, 30 oz cans	CALL	32 lb
NS W-GSGCRS24	Reusable Straw Foam Case of 12, 24 oz cans	CALL	29 lb
NS W-GSGCRS30	Reusable Straw Foam Case of 12, 30 oz cans	CALL	32 lb

NS=Not shown.

3. Great Stuff™ Pro Window and Door

Flexible seal permits expansion and contraction of foam, making it the preferred insulating foam sealant for filling the gap between a window or door and its rough opening.

Part Code	Description	Contr Price	Approx Wt
W-GSWD	Gun Foam Case of 12, 20 oz cans	CALL	21 lb
NS W-GSTWD	Straw Foam Case of 12, 20 oz cans	CALL	21 lb
NS W-GSWDRS20	Reusable Straw Foam Case of 12, 20 oz cans	CALL	21 lb

NS=Not shown.

4. Great Stuff™ Pro Wall and Floor Adhesive

One can is equal to 15 tubes of one-quart adhesive caulk. The product also reduces the number of mechanical fasteners needed—resulting in less material costs and fewer drywall nail “pops.”

Part Code	Description	Contr Price	Approx Wt
W-GSWF30	Gun Foam Case of 12, 30 oz cans	CALL	33 lb

5. Great Stuff™ Pro Gun Cleaner

Cleaner for dispensing guns and removing uncured foam.

Part Code	Description	Contr Price	Approx Wt
W-GCCS	Dow Foam Gun Cleaner Case of 12, 12 oz cans	CALL	15 lb

6. Dow® Foam Guns

Foam applicator guns with convenient re-startable, non-drip features developed for use with Dow® Foam Guns.

Part Code	Description	Contr Price	Approx Wt
A W-DEG13	Pro13 Gun	\$37.00	1 lb
B W-DEG14	Pro14 Gun	\$65.99	2 lb
NS W-DEG14L	Pro26.5 Long-Barrel Gun	\$113.40	3 lb
CW-DEG15	Pro15 Gun	\$121.25	2 lb
NS W-DEG14BT	Brass tips for W-DEG14	\$5.75	1 lb

NS=Not shown.

7. Boss® Biggies Industrial Wipes

These dual-sided industrial wipes clean paint, adhesives, oil and more from hands, tools and surfaces.

Part Code	Description	Size	Contr Price
W-BW	Dual-sided abrasive wipes 80 wipes per container	8" x 12"	\$25.95



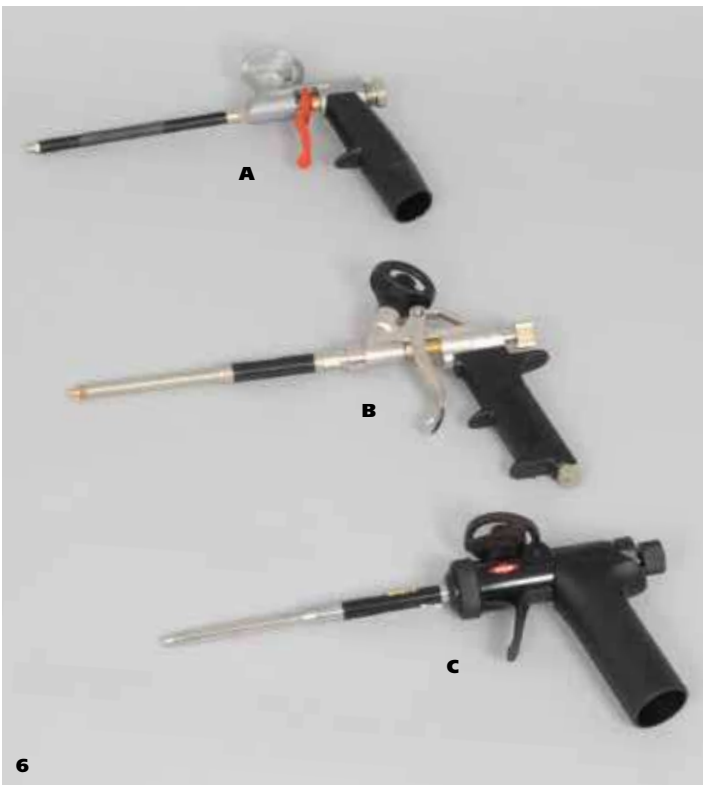

6



7

PROPER ATTACHMENT OF FOAM GUNS



1. Attach the gun to the can of Dow® Great Stuff™ Pro.



4. After removing the can from gun, clean the gun adapter with the Dow® Cleaner.



2. Always point the can away from your face.



5. Attach can to gun. Always point the can away from your face.



3. Shake can for 1 minute and immediately purge the air from gun.



6. Spray the cleaner through the gun.



1A



1B



1C



2



3

DOW® SEALANTS, INSULATIONS AND ADHESIVES

SIGNATURE
PRODUCT



1. Dow® Froth-Pak® Two Component Foam

Froth-Pak® is a foam machine in a carton. Chemical curing allows two-part polyurethane foam to be dispensed, expand and become tack-free in seconds. Froth-Pak® will skin over in 30–40 seconds and be completely cured in under one minute. Froth-Pak® is typically used as a foam-insulating sealant to fill cavities, wall and floor penetrations, cracks and expansion joints.

Froth-Pak® 12

Great for small jobs—12 Board Feet, 1 Cubic Foot

KIT INCLUDES: Iso (A) can, Polyol (B) can, 9-ft gun hose assembly (GHA), shoulder strap assembly, two cone white spray nozzles (187918).

Part Code	Description	Contr Price	Approx Wt
A W-1FRPK12	Sealant Kit	CALL	4 lb
NS A W-FRPK12	Case of 12 Sealant Kits	CALL	40 lb

NS=Not shown.

Froth-Pak® 180

200 Board Feet—16.6 Cubic Feet

KIT INCLUDES: Iso (A) cylinder, Polyol (B) cylinder, six cone white spray nozzles (187918), four GG white spray nozzles (187915), 9-ft gun hose assembly (GHA), petroleum jelly packet.

Part Code	Description	Contr Price	Approx Wt
B W-FRPK180	Sealant Kit	CALL	39 lb
NS B W-FP200CA	Insulation Kit, Class A	CALL	39 lb

NS=Not shown.

Froth-Pak® 600

600 Board Feet/50 Cubic Feet

KIT INCLUDES: Iso (A) cylinder, Polyol (B) cylinder, eight cone white spray nozzles (187918), four fan spray nozzles, 15-ft gun hose assembly (GHA), petroleum jelly packet.

Part Code	Description	Contr Price	Approx Wt
C W-FP600	Sealant Kit	CALL	117 lb
NS C W-FP620CA	Insulation Kit, Class A	CALL	118 lb

NS=Not shown.

2. Froth-Pak® 160 Slow Rise

Low pressure foam for blind cavity and abandoned pipe filling. 160 Board Feet—13.3 Cubic Feet

Part Code	Description	Contr Price	Approx Wt
W-FP160SR	Single Kit/Sealant	CALL	39 lb

3. Insta-Stik™ Adhesive

Insta-Stik™ is a professional polyurethane adhesive for attaching compatible roof insulation boards to roof decks and substrates in new commercial construction and roof replacement applications.

KIT INCLUDES: Tank, hose, wand, flared nozzle, coupler, valve, wrench and instructions.

Part Code	Description	Contr Price	Approx Wt
W-ISTKK	Complete Insta-Stik Kit	CALL	28 lb
NS W-ISTKT	Insta-Stik Tank Only	CALL	28 lb

NS=Not shown.

See www.wind-lock.com for technical information.

Replacement nozzles available, please call for more information.





DOW® WEATHERMATE™ WEATHERIZATION

SIGNATURE
PRODUCT

1. Dow® Weathermate™ Sill Pan

Weathermate™ Sill Pan is a translucent, molded polymer that is manufactured to ensure a consistent thickness. It will not rust or rot and is compatible with standard adhesives and sealants. It provides seamless protection at sill corners and assists positive drainage of water to the exterior. The two-piece design adjusts to fit most window sill widths.

Part Code	Size	Description	Contr Price	Approx Wt
W-DSP5	5" x 32"/pan	Sold by The Box (25 sets)	CALL	7 lb

2. Dow® Weathermate™ Construction Tape

Weathermate™ Construction Tape is recommended to seal the joints and seams of Styrofoam™ Weathermate™ housewraps and Styrofoam insulated sheathings. In these applications, Weathermate™ Construction Tape enhances resistance to moisture and air infiltration. The tape can also be used to repair damaged foam insulation or housewrap, reducing material costs and job-site waste.

Part Code	Rolls/Box	Description	Contr Price	Approx Wt
W-DCT178	16	1-7/8" x 165'/Roll	CALL	1 lb
W-DCT278	16	2-7/8" x 165'/Roll	CALL	1 lb

3. Dow® Weathermate™ Straight Flashing

Weathermate™ Straight Flashing combines a blue high-density polyethylene (HDPE) film facer with a butyl rubber adhesive that forms a strong mechanical and chemical bond to most building materials. A polymeric-coated paper release liner provides a more consistent peel than plain paper liners. It provides seamless protection at jambs and straight heads.

Part Code	Rolls/Box	Description	Contr Price	Approx Wt
W-DSF4	6	4" x 100'/Roll	CALL	5 lb
W-DSF6	6	6" x 100'/Roll	CALL	8 lb
W-DSF9	3	9" x 100'/Roll	CALL	12 lb

4. Dow® Weathermate™ Flexible Flashing

Weathermate™ Flexible Flashing combines a blue creped high-density polyethylene (HDPE) film facer with a butyl rubber adhesive that forms a strong mechanical and chemical bond to most building materials. A polymeric-coated kraft paper release liner provides a more consistent peel than plain paper liners. It provides seamless protection around curved openings and custom shapes.

Part Code	Rolls/Box	Description	Contr Price	Approx Wt
W-DFF6	1	6" x 75'/Roll	CALL	11 lb
W-DFF9	1	9" x 75'/Roll	CALL	17 lb

5. Dow® Weathermate™ Plus Housewrap

Dow® Weathermate™ Plus housewrap is a non-woven, non-perforated, polyolefin-based housewrap that offers exceptional tear resistance and durability. It is an effective option for builders who prefer to use non-insulating sheathing along with housewrap. When installed over sheathing, Dow® Weathermate™ Plus housewrap reduces costly air and moisture infiltration. It is translucent to allow a clear view of the studs and the sheathing surface during installation.

Part Code	Description	Contr Price	Approx Wt
W-DWM3165	3' x 165'/Roll	CALL	14 lb/Roll
W-DWM5100	5' x 100'/Roll	CALL	14 lb/Roll
W-DWM9100	9' x 100'/Roll	CALL	24 lb/Roll
W-DWM9150	9' x 150'/Roll	CALL	34 lb/Roll

All other Dow® Weathermate™ Plus housewrap sizes are available. Please call.

*The exclusive specified fastener
for DOW's Thermax wall system.*



CI-LOCK (CONTINUOUS INSULATION)

1. ci-LOCK Fastener

The Dow® specified fastener for use with the Thermax continuous insulation wall system.

Part Code	Qty/Box	Insulation Thickness	Screw Size	Contr Price	Approx Wt/Box
DTW-3S1	1000	5/8"	#6 x 1-5/8"	CALL	12 lb
DTW-3S2	1000	1"	#6 x 2"	CALL	14 lb
DTW-3S3	1000	1.55"	#8 x 2-5/8"	CALL	18 lb
DTW-3S4	1000	2"	#8 x 3"	CALL	19 lb
DTW-3S45	1000	2.5"	#8 x 3-1/2"	CALL	19 lb
DTW-3S5	1000	3"	#10 x 4"	CALL	27 lb



INSTALLATION ESSENTIALS

1. DryFlekt® Polypropylene Kickout Flashing

The best practice solution for diverting roofline water. The patented design creates a backward and outward water flow off the roof and away from walls, preventing water intrusion at roof-to-wall intersections. DryFlekt® is manufactured in left and right parts, available in six aesthetically pleasing colors: brown, bronze, sand, tan, gray and white.

Part Code	Size	Description	Contr Price	Approx Wt
A	W-PKOLB 14" x 6"	Brown Kickout Diverter LH Polypro	\$10.95	1 lb
A	W-PKORB 14" x 6"	Brown Kickout Diverter RH Polypro	\$10.95	1 lb
B	W-PKORBZ 14" x 6"	Bronze Kickout Diverter RH Polypro	\$10.95	1 lb
B	W-PKOLBZ 14" x 6"	Bronze Kickout Diverter LH Polypro	\$10.95	1 lb
C	W-PKORS 14" x 6"	Sand Kickout Diverter RH Polypro	\$10.95	1 lb
C	W-PKOLS 14" x 6"	Sand Kickout Diverter LH Polypro	\$10.95	1 lb
D	W-PKOLT 14" x 6"	Tan Kickout Diverter LH Polypro	\$10.95	1 lb
D	W-PKORT 14" x 6"	Tan Kickout Diverter RH Polypro	\$10.95	1 lb
E	W-PKOLG 14" x 6"	Gray Kickout Diverter LH Polypro	\$10.95	1 lb
E	W-PKORG 14" x 6"	Gray Kickout Diverter RH Polypro	\$10.95	1 lb
F	W-PKOLW 14" x 6"	White Kickout Diverter LH Polypro	\$10.95	1 lb
F	W-PKORW 14" x 6"	White Kickout Diverter RH Polypro	\$10.95	1 lb

2. Hammer Tackers and Staples

Use for fast attachment of AccuVent and building wraps. Single-handed grip for easy operations. Reliable and durable with no loose parts.

Kits

Part Code	Description	Contr Price	Approx Wt/Box
T-KHTR19	R19 Tacker and 1 box of 1/4" staples	\$28.95	2 lb
T-KHTR11	R11 Tacker and 2 boxes of staples 1/4" and 3/8"	\$53.50	3 lb

Tackers and staples available individually.

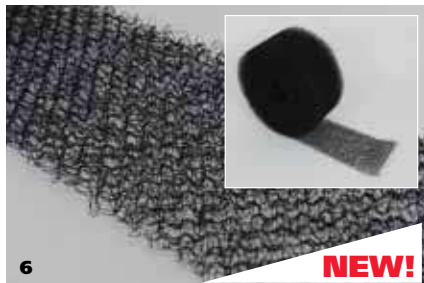

3. Tyvek® StuccoWrap® and Sheathing Tape

Tyvek® StuccoWrap® from DuPont® is designed and engineered for comfort, energy efficiency and protection from water and moisture damage.

Part Code	Qty/Skid	Size	Description	Contr Price	Approx Wt
NS W-TST	36	2" x 55 yd	Sheathing Tape	CALL	18 lb
W-TSW5	9	5' x 200'	StuccoWrap	CALL	144 lb

NS=Not shown.

4. Weather Trek EVD House Wrap

Weather Trek EVD housewrap is the perfect housewrap for EIFS and stucco construction.

Part Code	Qty/Skid	Size	Contr Price/Pc	Approx Wt/Box
W-WTK	36	5' x 200'	CALL	144 lb

5. Benjamin Obdyke Home Slicker® NEW!

Benjamin Obdyke Home Slicker® products block rain and moisture in new and reconstructed walls.

Part Code	Qty/Skid	Size	Description	Contr Price	Approx Wt
NS W-HSST	16	39"x61.5', 200 sq ft	Stone & Stucco Rainscreen 6 mil	\$137.45	16 lbs
NS W-HS10ST	16	39"x38.5', 125 sq ft	Stone & Stucco Rainscreen 10 mil	\$113.25	25 lbs
W-HSPT	16	39"x61.5', 200 sq ft	Plus Typar Rainscreen 6 mil	\$137.45	15 lbs
NS W-HS10PT	16	39"x38.5', 125 sq ft	Plus Typar Rainscreen 10 mil	\$113.25	15 lbs
NS W-HS	16	39"x46.5', 150 sq ft	Rainscreen 6 mil	\$88.05	10 lbs
NS W-HS10N	16	39"x38.5', 125 sq ft	Rainscreen 10 mil	\$86.30	8 lbs

NS=Not shown.

6. Benjamin Obdyke Blockade™ NEW!

The Blockade™ system blocks mortar from clogging the weep holes allowing moisture to flow freely out of the wall cavity.

Part Code	Qty/Skid	Size	Description	Contr Price	Approx Wt
W-BA80	16	50'x10"x.80"	80 Mortar Deflection .80" thick	\$37.50	5 lb
W-BA150	16	50'x10"x1.5"	80 Mortar Deflection 1.5" thick	\$56.35	4 lb

7. Insul-Knife™

Insul-Knife™ is one of those time-saving tools that you will wonder how you ever lived without. It is perfect for easily cutting all type of insulations including: eps foam, fiberglass, sponge foam and cotton fiber. It is an excellent tool for trimming unwanted excess foam insulation after it expands and cures.

Part Code	Description	Contr Price
W-INSULKIT	Multipurpose Insulation Knife Kit (Knife and Sharpener)	\$42.95
W-INSULS	Insulation Knife Sharpener	\$10.99

8. AccuVent® Venting Systems

AccuVent is an excellent attic ventilation system that allows you to insulate the entire outer wall of the home and is simply installed with only 6 staples. Sold only by the bundle.

Part Code	Description	Size	Contr Price
W-AVLG	Original AccuVent, 24" o.c.	50/bundle	CALL
W-AVSM	Original AccuVent, 16" o.c.	50/bundle	CALL
W-EAVLG	High Energy Extreme, 24" o.c.	50/bundle	CALL
W-EAVSM	High Energy Extreme, 16" o.c.	50/bundle	CALL
W-CSSLG	Cathedral Starter Strip, 24" o.c.	50/bundle	CALL
W-CSSSM	Cathedral Starter Strip, 16" o.c.	50/bundle	CALL
W-CCVLG	Cathedral Ceiling Vent Extension, 24" o.c.	50/bundle	CALL
W-CCVSM	Cathedral Ceiling Vent Extension, 16" o.c.	50/bundle	CALL
W-ABLG	AccuBlock, 24" o.c.	50/bundle	CALL
W-ABSM	AccuBlock, 16" o.c.	50/bundle	CALL

STEALTH ACCESS PANELS

Stealth Access Panels by Wind-lock® are a standout product made of glass fiber reinforced gypsum (GFRG) to blend seamlessly into a drywall ceiling or wall. They're an attractive, rust-free alternative to metal panels or fabricated access that must be hidden in closets.



STEALTH ACCESS PANELS BY WIND-LOCK®

EXCLUSIVE
PRODUCT

Stealth Access Panels provide an aesthetically pleasing, easy-to-install solution for a more attractive interior, even where access is frequently required. For a demonstration of how easy installation can be, visit www.wind-lock.com and view a Stealth Installation Video.

Versatile Stealth Access Panels are available in various standard, commercial and residential sizes for both new and retrofit construction across unlimited applications. Their smart design helps contractors work smarter, faster and better.

Stealth Access Panel advantages include:

- Tapered edge for tape joint
- Easily textured
- Lightweight
- Smooth rounded edge
- Blends into surrounding drywall
- No shrinking or cracking
- Perfect for retrofit applications
- Single trade installation
- Reduced labor costs

1. Ceiling Access Panels

Showcase your space, not your access panel. Stealth Access Panels are designed to be an attractive alternative to typical access panels in commercial and residential buildings.

Their GFRG-based design can't rust and blends in seamlessly with either new or retrofitted drywall ceilings.

That helps you preserve aesthetic style, because design should be noticed, but access panels should not.

Commercial Panels

Part Code	Access Opening	Rough Opening	Contr Price	Approx Wt per panel
TR-AP009	9" x 9"	15" x 15"	CALL	6 lb
TR-AP012	12" x 12"	18" x 18"	CALL	9 lb
TR-AP016	16" x 16"	22" x 22"	CALL	10 lb
TR-AP018	18" x 18"	24" x 24"	CALL	11 lb
TR-AP024	24" x 24"	30" x 30"	CALL	16 lb
TR-AP036	36" x 36"	42" x 42"	CALL	16 lb

Sold 2 per box. Custom sizes available.

Residential Panels

Part Code	Access Opening	Rough Opening	Contr Price	Approx Wt per panel
TR-APGR2230 (with gasket)	22" x 30"	24" x 36"	CALL	16 lb
TR-APGR3030 (with gasket)	30" x 30"	36" x 36"	CALL	20 lb

Sold 2 per box. Custom sizes available.

HOW TO SELECT AN ACCESS PANEL

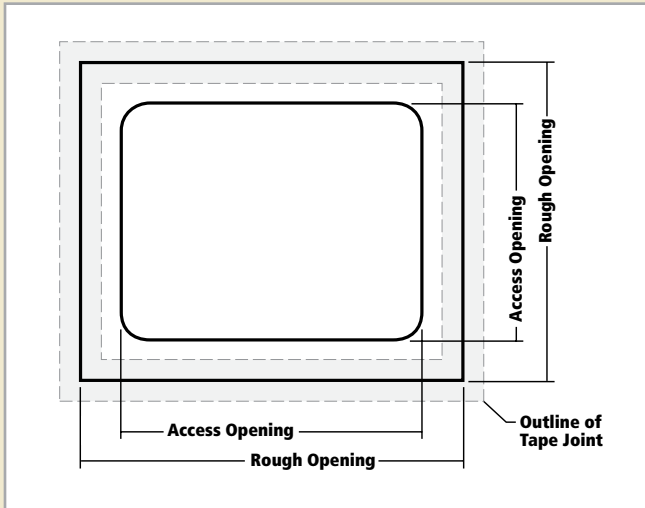

Stealth™ Access Panels are selected by their access opening size.

2. Hinged Access Panels

Designed for both wall and ceiling applications, hinged Stealth Access Panels by Wind-lock® are made of GFRG and can be used where a locked door is needed and interior style must be maintained.

Part Code	Access Opening	Rough Opening	Contr Price	Approx Wt per panel
TR-HAP009	9" x 9"	15" x 15"	CALL	8 lb
TR-HAP012	12" x 12"	18" x 18"	CALL	10 lb
TR-HAP016	16" x 16"	22" x 22"	CALL	12 lb
TR-HAP018	18" x 18"	24" x 24"	CALL	13 lb
TR-HAP024	24" x 24"	30" x 30"	CALL	17 lb

3. Specialty Round Panels

The innovative round Stealth Access Panel by Wind-lock® is made from GFRG and is designed to blend seamlessly into a drywall ceiling featuring circular light fixtures, speakers or smoke detectors. That allows you to provide access while maintaining the aesthetic theme of the interior design.

Part Code	Access Opening	Rough Opening	Contr Price	Approx Wt per panel
TR-RAP012	12" diameter	18" x 18"	CALL	9 lb
TR-RAP016	16" diameter	22" x 22"	CALL	10 lb
TR-RAP018	18" diameter	24" x 24"	CALL	11 lb
TR-RAP024	24" diameter	30" x 30"	CALL	16 lb

Sold 2 per box. Custom sizes available. Call for more details.



Stock to Dock Shipping Guarantee

Products highlighted in yellow are guaranteed to ship within 24 hours or freight costs are **FREE!** Larger orders may require additional lead times. Call for details.



HOW TO INSTALL ACCESS PANELS



1. Frame the opening.



2. Mount Stealth surround with drywall screws.



3. Install drywall and place access panel in opening.



4. Tape and apply drywall compound.



BLACK LAB APPAREL™ & PROMOTIONS

Proudly display your company names and brands with outerwear, headgear, shirts, sweaters, golf gear and more, all emblazoned with names and/or logos. Black Lab Apparel™ helps you market your company and establish your brand in a fun and appealing way.

See our
website for
additional
casual wear.



BRANDED WEARABLES AND ACCESSORIES

We deliver what you need to wear, when you need to wear it—helping you achieve the look you want any time of the year and for any occasion. We can also help you plan and budget annually for your event and marketing calendar.

Black Lab Apparel offers customizable:

- Hats, Tees, Sweats
- Oxfords, Gabardines, Twills, Polos
- Shirts, Jackets, Vests
- Beanies, Bags, Travel Kits

Your logoed apparel makes a statement. Consider it for:

- Employee branding programs
- Golf tournaments
- Vendor days
- Trade shows
- Customer appreciation days
- Employee appreciation days

Black Lab Apparel Services:

- Embroidery
- Screen printing
- Online stores
- Logo digitizing
- Fulfillment
- Sewn samples
- Bagging of garments
- Promotional items



Join Us on These Social Networks

Black Lab Apparel is now on Twitter, Facebook and YouTube. That's three more ways for you to get a jump on new offers, discounts and a wide range of attractive brandable products. Check us out online at www.blacklabapparel.com and directly link to the network of your choice.

To have Black Lab Apparel help you gear up, shop at www.blacklabapparel.com or call us at 877-415-9862.



Description	Part Code	Page	Description	Part Code	Page
AccuBlock, 16" o.c.	W-ABSM	85	Backer Rod, Sof-Rod, 7/8"	W-SR78	26
AccuBlock, 24" o.c.	W-ABLG	85	Backer Rod, Sof-Rod, 7/8", Handi Pack	W-SR78H	26
AccuVent, cathedral ceiling vent extension, 16" o.c.	W-CCVSM	85	Benjamin Obdyke Blockade, 1.5' thick	W-BA150	25, 55, 85
AccuVent, cathedral ceiling vent extension, 24" o.c.	W-CCVLG	85	Benjamin Obdyke Blockade, .80' thick	W-BA80	25, 55, 85
AccuVent, cathedral starter strip, 16" o.c.	W-CSSSM	85	Benjamin Obdyke rainscreen, 10 mil	W-HS10N	25, 55, 85
AccuVent, cathedral starter strip, 24" o.c.	W-CSSLG	85	Benjamin Obdyke rainscreen, 6 mil	W-HS	25, 55, 85
AccuVent, high energy extreme, 16" o.c.	W-EAVSM	85	Beveled Groove Blade, 1" x 1/2" x 3/4"	HB-102	19
AccuVent, high energy extreme, 24" o.c.	W-EAVLG	85	Beveled Groove Blade, 1" x 3/4" x 1/2"	HB-104	19
AccuVent, original, 16" o.c.	W-AVSM	85	Beveled Groove Blade, 1-1/2" x 1" x 7/8"	HB-151	19
AccuVent, original, 24" o.c.	W-AVLG	85	Beveled Groove Blade, 1-1/2" x 3/4" x 1"	HB-154	19
Adjustment Tool, Jamb Jack	W-JJAT	77	Beveled Groove Blade, 2" x 1" x 1-3/8"	HB-201	19
Anchor Tunnel, 6"	I-AT	74	Beveled Groove Blade, 2" x 3/4" x 1-1/2"	HB-204	19
Anchor Tunnel, 6", 50 pack	I-AT50	74	Beveled Groove Blade Kit, 1" x 1/2" x 3/4"	KB-102	18
Anchor Tunnel, Spanner wrench	I-ATW	74	Beveled Groove Blade Kit, 1" x 3/4" x 1/2"	KB-104	18
Anchor, tieKey	W-BTK	67	Beveled Groove Blade Kit, 1-1/2" x 1" x 7/8"	KB-151	18
Angled Groove Blade, 1" x 1/2" x 1/2"	HA-102	19	Beveled Groove Blade Kit, 1-1/2" x 3/4" x 1"	KB-154	18
Angled Groove Blade, 1" x 3/4" x 1/4"	HA-104	19	Beveled Groove Blade Kit, 2" x 1" x 1-3/8"	KB-201	18
Angled Groove Blade, 1-1/2" x 1/2" x 1"	HA-152	19	Beveled Groove Blade Kit, 2" x 3/4" x 1-1/2"	KB-204	18
Angled Groove Blade, 1-1/2" x 3/4" x 3/4"	HA-154	19	Beveled Groove Sled, 1" x 1/2" x 3/4"	GSB-102	19
Angled Groove Blade, 2" x 1" x 1"	HA-201	19	Beveled Groove Sled, 1" x 3/4" x 1/2"	GSB-104	19
Angled Groove Blade, 2" x 1/2" x 1-1/2"	HA-202	19	Beveled Groove Sled, 1-1/2" x 1" x 7/8"	GSB-151	19
Angled Groove Blade, 2" x 3/4" x 1-1/4"	HA-204	19	Beveled Groove Sled, 1-1/2" x 3/4" x 1"	GSB-154	19
Angled Groove Blade, 3" x 1" x 2"	HA-301	19	Beveled Groove Sled, 2" x 1" x 1-3/8"	GSB-201	19
Angled Groove Blade Kit, 1" x 1/2" x 1/2"	KA-102	18	Beveled Groove Sled, 2" x 3/4" x 1-1/2"	GSB-204	19
Angled Groove Blade Kit, 1" x 3/4" x 1/4"	KA-104	18	Blade holder parts, knife	2-QCRK	61, 62
Angled Groove Blade Kit, 1-1/2" x 1/2" x 1"	KA-152	18	Blade holder parts, sled	Q-SLED6RK	61
Angled Groove Blade Kit, 1-1/2" x 3/4" x 3/4"	KA-154	18	Blade holder replacement parts, brass blade	2-QCRK	15, 62
Angled Groove Blade Kit, 2" x 1" x 1"	KA-201	18	Blade holder replacement parts, brass sled	Q-SLED6RK	15, 62
Angled Groove Blade Kit, 2" x 1/2" x 1-1/2"	KA-202	18	Blade material, flat, 12" roll	Q-SBMR12	15, 62
Angled Groove Blade Kit, 2" x 3/4" x 1-1/4"	KA-204	18	Blade material, flat, 12", 3 pack	Q-SBM123	15, 62
Angled Groove Blade Kit, 3" x 1" x 2"	KA-301	18	Blade material, flat, 12", 8 pack	Q-SBM128	15, 62
Angled Groove Sled, 1" x 1/2" x 1/2"	GSA-102	19	Blade material, flat, 24" roll	Q-SBMR24	15, 62
Angled Groove Sled, 1" x 3/4" x 1/4"	GSA-104	19	Blade material, round, 24"	Q-RBM243	15, 62
Angled Groove Sled, 1-1/2" x 1/2" x 1"	GSA-152	19	Blade, 1/2" x 3" Square	QS-50	61
Angled Groove Sled, 1-1/2" x 3/4" x 3/4"	GSA-154	19	Blade, Board Beveler	Q-EPSBB	14
Angled Groove Sled, 2" x 1" x 1"	GSA-201	19	Blade, Conduit Cutter	Q-CON	61
Angled Groove Sled, 2" x 1/2" x 1-1/2"	GSA-202	19	Blade, Electric Box Cutter Kit	Q-EBXK	61
Angled Groove Sled, 2" x 3/4" x 1-1/4"	GSA-204	19	Blade, Electric Box Cutter, 2-1/2"	Q-EBX2	61
Angled Groove Sled, 3" x 1" x 2"	GSA-301	19	Blade, Electric Box Cutter, 4-1/2"	Q-EBX4	61
Ansel cut protection glove, large	W-KEVGLG	17, 72	Blade, ICF Tongue and Groove	I-TGB	61
Ansel cut protection glove, medium	W-KEVGMD	17, 72	Blade, SIP Replacement Kit	Q-SIPBK	69
Applicator Tool Bag Kit, Comfort-Soft handles	W-TBK2CS	32	Blade, Straight, 2"	Q-SB2	14
Applicator Tool Bag Kit, wood handles	W-TBK2	32	Blade, Straight, 2"	Q-SB2	61
Backer Rod, Hard-rod, 1/2"	W-SR48	26	Blade, Straight, 4"	Q-SB4	14
Backer Rod, Hard-rod, 1/2", Handi Pack	W-SR48H	26	Blade, Straight, 4"	Q-SB4	61
Backer Rod, Hard-rod, 3/4", Handi Pack	W-HR34H	26	Blade, Straight, 6"	Q-SB6	14
Backer Rod, Hard-rod, 3/8", Handi Pack	W-HR38H	26	Blade, Straight, 6"	Q-SB6	61
Backer Rod, Hard-rod, 5/8", Handi Pack	W-HR58H	26	Blade, Stud Cutter Kit	Q-STUDK	61
Backer Rod, Sof-Rod, 1-1/2"	W-SR112	26	Blade, Stud Cutter, 3-1/2" x 3"	Q-STUD4	61
Backer Rod, Sof-Rod, 3/8"	W-SR38	26	Blade, Stud Cutter, 5-1/2" x 3"	Q-STUD6	61
Backer Rod, Sof-Rod, 3/8", Handi Pack	W-SR38H	26	Blade, Taper Block Cutter	I-TBC	61
Backer Rod, Sof-Rod, 5/8"	W-SR58	26	Bond Breaker Tape, 1" x 108'	W-BBT1	45
Backer Rod, Sof-Rod, 5/8", Handi Pack	W-SR58H	26	Bond Breaker Tape, 1/2" x 108'	W-BBT12	45

Description	Part Code	Page	Description	Part Code	Page
Bond Breaker Tape, 1/4" x 108'	W-BBT14	45	ci-Lock Fastener for Dow Thermax continuous insulation system, 1.55" thickness	DTW-3S3	84
Bond Breaker Tape, 3/4" x 108'	W-BBT34	45	ci-Lock Fastener for Dow Thermax continuous insulation system, 2" thickness	DTW-3S4	84
Bond Breaker Tape, 3/8" x 108'	W-BBT38	45	ci-Lock Fastener for Dow Thermax continuous insulation system, 2.5" thickness	DTW-3S45	84
Boss Biggies industrial wipes	W-BW	32, 49, 71, 80	ci-Lock Fastener for Dow Thermax continuous insulation system, 3" thickness	DTW-3S5	84
Bottle opener, Comfort-Soft	T-BOOP	37	ci-Lock Fastener for Dow Thermax continuous insulation system, 5/8" thickness	DTW-3S1	84
Bow Cutter, 12" with power box	I-BC12	47, 75	Cleaner, Tool, Big O, Gallon	W-AOJ	49
Bow Cutter, 24"	I-BC24	47, 75	Cleaner, Tool, Big O, Spray can	W-AOC	49
Bow Cutter, 24" with Magnum	I-MBC24	47, 75	Cleaner, Tool, Spray Can	W-TM	49
Bow Cutter, 48"	I-BC48	47, 75	Concrete Slump Kit	W-SCK	72
Bow Cutter, 48" with Magnum	I-MBC48	47, 75	Concrete Vibrator, Gas Powered	I-HVHE	72
Brass Tips, Pro 14 Foam Gun	W-DEG14BT	80	Congrip Masonry Fastener	W-MCG0	11
Brick Hammer	T-SBH	52	Congrip Masonry Fastener	W-MCG1	11
Brush, Blister	BB-GB	48	Congrip Masonry Fastener	W-MCG2	11
Brush, Blister, Replacement pad	BB-GBR	48	ConTrol Nylon Fiber Reinforcement, 1 bag	I-SCON	43
Brush, Bucket, 6"	B-BB6	48	ConTrol Nylon Fiber Reinforcement, 150 bags	I-RCONPOP	43
Brush, Smoothing, 1", 12 pack	B-SM1PK	48	ConTrol Nylon Fiber Reinforcement, 36 bags	I-CONPOP	43
Brush, Smoothing, 2", 12 pack	B-SM2PK	48	Corner Beads, metal, 8' with expanded veneer	ECVHDG	51
Brush, Tampico clean-up, 20"	B-BB20	48	Corner Beads, metal, 8', #33 wide flange	W-CB33W	51
Brush, Tampico clean-up, 8-1/2"	B-GTAB	48	Corner Beads, metal, 8', 1" expanded flange	W-CB01E	51
Buck Plates	BUK-302	67	Corner Plate, Jamb Jack	W-JJCP	77
Buck Plates	BUK-3WLM1	67	Darbie, Aluminum, 118-3/8", Leveling	AL-10	41
Buck Plates	BUK-3WLM2	67	Darbie, Aluminum, 42", Scratcher	T-SCD42	41
Buck Plates	BUK-3WLM3	67	Darbie, Aluminum, 48", Browning, H Style	HBD-4	41
Buck Plates	BUK-3WLM4	67	Darbie, Aluminum, 48", Trapezoid	TBD-4	41
Buck Plates	BUK-3WLM5	67	Darbie, Aluminum, 59-3/8", Leveling	AL-5	41
Bucket Dipper, CRS, Wood	T-BD	42	Darbie, Aluminum, 60", Trapezoid	TBD-5	41
Bucket Dredger	B-DR	42	Darbie, Aluminum, 72", Browning, H Style	HBD-6	41
Bucket Opener, 3 in 1	B-BO2	32, 42	Darbie, Aluminum, 79", Leveling	AL-6	41
Bucket Opener, Plastic	B-BO3	42	Darbie, Aluminum, 96", Browning, H Style	HBD-8	41
Bucket Opener, The Hero	B-BO1	42	Darbie, Aluminum, 98-5/8", Leveling	AL-8	41
Casing Beads, metal, 8' x 5/8" with #66 expanded flange	W-CBPSEF7	51	Darbie, Magnesium, 42", Serrated	T-DSSM42	41
Casing Beads, metal, 8' x 1/2" with #66 expanded flange	W-CBPSEF5	51	Dow 790 Sealant, Adobe tan	W-DCAT	26
Casing Beads, metal, 8' x 1/2" with #66 expanded flange	W-CBPSEF6	51	Dow 790 Sealant, Black	W-DCBK	26
Casing Beads, metal, 8' x 3/4" with #66 expanded flange	W-CBPSEF7	51	Dow 790 Sealant, Gray	W-DCGR	26
Casing Beads, metal, 8' x 3/4" with #66 expanded flange	W-CBPSEF8	51	Dow 790 Sealant, Natural stone	W-DCNS	26
Casing Beads, metal, 8' x 1" with #66 expanded flange	W-CBPSEF1	51	Dow 790 Sealant, Precast white	W-DCPC	26
Casing Beads, metal, 8' x 3/8" with #66 expanded flange	W-CBPSEF3	51	Dow CWS Sealant, Antique White	W-DRAW	26
Casing Beads, metal, 8' x 3/8" with #66 expanded flange	W-CBPSEF4	51	Dow CWS Sealant, Black	W-DRBK	26
Casing Beads, metal, 8' x 5/8" with #66 expanded flange	W-CBPSEF6	51	Dow CWS Sealant, Bronze	W-DRBZ	26
Casing Beads, metal, 8' x 7/8" with #66 expanded flange	W-CBPSEF8	51	Dow CWS Sealant, Gray	W-DRGR	26
Caulking Spatula Kit	W-DSKIT	26	Dow CWS Sealant, Limestone	W-DRLS	26
Caulking Spatula, 3" x 5/8"	W-DS3	26	Dow CWS Sealant, Sandstone	W-DRSS	26
Caulking Spatula, 4" x 5/8"	W-DS4	26	Dow CWS Sealant, True White	W-DRTW	26
Caulking Spatula, 6" x 1"	W-DS6	26	Dow Pro 13 Foam Gun	W-DEG13	80
Chemical, Efflorescence Remover	MP-G2112	50	Dow Pro 14 Foam Gun	W-DEG14	80
Chemical, General Purpose Cleaner	MP-2107G	50	Dow Pro 14 Foam Gun, 26 1/2" Nozzle	W-DEG14L	80
Chemical, Mildew Remover	W-MMRC	50	Dow Pro 15 Foam Gun	W-DEG15	80
Chemical, Rust Remover	MP-G2108	50	Dow Weathermate Construction Tape, 1-7/8" x 165' 00" x 00'	W-DCT178	83
Chemical, Titan Penetrating Sealer, 1 Gallon	W-TPS1	50			
Chemical, Titan Penetrating Sealer, 5 Gallons	W-TPS5	50			
Chisel, Mason's, 4" x 8-3/4"	T-CH	52			
ci-Lock Fastener for Dow Thermax continuous insulation system, 1" thickness	DTW-3S2	84			

Description	Part Code	Page	Description	Part Code	Page
Dow Weathermate Construction Tape, 2-7/8" x 165'	W-DCT278	83	Edger, Outside Corner, 3/4", SS, Comfort-Soft	T-E75RCS	33
Dow Weathermate Flexible Flashing, 6" x 75'	W-DF6	83	Edger, Outside Corner, 3/4", SS, Wood	T-E75	34
Dow Weathermate Flexible Flashing, 9" x 75'	W-DF9	83	Edger, Outside Corner, SS, Comfort-Soft Kit	T-EKITCS	31
Dow Weathermate Housewrap 3' x 165'	W-DWM3165	24, 83	Edger, Outside Corner, SS, Wood Kit	T-EKIT	34
Dow Weathermate Housewrap 5' x 100'	W-DWM5100	24, 83	Electrical Box, double gang	I-ICEDBL	74
Dow Weathermate Housewrap 9' x 100'	W-DWM9100	24, 83	Electrical Box, single gang	I-ICESGL	74
Dow Weathermate Housewrap 9' x 150'	W-DWM9150	24, 83	Electrical Box, triple gang	I-ICETPL	74
Dow Weathermate Sill Pan	W-DSP5	83	EnerFoam Sealant, 24 oz can, gun foam	W-EF2524	80
Dow Weathermate Straight Flashing, 4" x 100'	W-DSF4	83	EnerFoam Sealant, 24 oz can, straw foam	W-EF24RS24	80
Dow Weathermate Straight Flashing, 6" x 100'	W-DSF6	83	EnerFoam Sealant, 30 oz can, gun foam	W-EF4230	80
Dow Weathermate Straight Flashing, 9" x 100'	W-DSF9	83	Expansion Joint, metal, 8' with #15 1/2" expansion joint	W-CJE3	51
Edger, 1", 90°, left, wood handle	T-90L1	34	Expansion Joint, metal, 8' with #15 3/8" expansion joint	W-CJE5	51
Edger, 1", 90°, right, wood handle	T-90R1	34	Fastener, Hard-Roc	F-HR114	12
Edger, 1-1/2", 90°, left, wood handle	T-90L15	34	Fastener, Hard-Roc	F-HR158	12
Edger, 1-1/2", 90°, right, wood handle	T-90R15	34	Fastener, Hard-Roc	F-HR114S	12
Edger, 1-1/4", 45°, left, wood handle	T-45L1	34	Fastener, Hard-Roc	F-HR158S	12
Edger, 1-1/4", 45°, right, wood handle	T-45R1	34	Fastener, Masonry Tapcon	UM-1	12
Edger, 2", 45°, left, wood handle	T-45L15	34	Fastener, Masonry Tapcon	UM-2	12
Edger, 2", 45°, right, wood handle	T-45R15	34	Fastener, Masonry Tapcon	UM-3	12
Edger, 2", 90°, left, wood handle	T-90L2	34	Fastener, Masonry Tapcon	UM-4	12
Edger, 2", 90°, right, wood handle	T-90R2	34	Fastener, Masonry Tapcon	UM-5	12
Edger, 2-3/4", 45°, left, wood handle	T-45L2	34	Fastener, Steel	US-1	12
Edger, 2-3/4", 45°, right, wood handle	T-45R2	34	Fastener, Steel	US-2	12
Edger, 3/4", 90° left, wood handle	T-90L75	34	Fastener, Steel	US-3	12
Edger, 3/4", 90°, right, wood handle	T-90R75	34	Fastener, Steel	US-4	12
Edger, 45°, left, wood handle, kit	T-45LKIT	34	Fastener, Steel	US-5	12
Edger, 45°, right, wood handle, kit	T-45RKIT	34	Fastener, Steel	US-6	12
Edger, 90°, left, wood handle, kit	T-90LKIT	34	Fastener, Steel	US-7	12
Edger, 90°, right, wood handle, kit	T-90RKIT	34	Fastener, Steel	US-8	12
Edger, Inside Corner, 1", SS, Comfort-Soft	T-EI1CS	31	Fastener, Wafer-Head	F-WH114	12
Edger, Inside Corner, 1", SS, Comfort-Soft	T-EI1RCS	33	Fastener, Wafer-Head	F-WH158	12
Edger, Inside Corner, 1", SS, Wood	T-EI1	34	Fastener, Wafer-Head	F-WH114S	12
Edger, Inside Corner, 1.5", SS, Comfort-Soft	T-EI15CS	31	Fastener, Wafer-Head	F-WH158S	12
Edger, Inside Corner, 1.5", SS, Comfort-Soft	T-EI15RCS	33	Fastener, Wood, economy	UZW-1	12
Edger, Inside Corner, 1.5", SS, Wood	T-EI15	34	Fastener, Wood, economy	UZW-2	12
Edger, Inside Corner, 2", SS, Comfort-Soft	T-EI2RCS	33	Fastener, Wood, economy	UZW-3	12
Edger, Inside Corner, 2", SS, Wood	T-EI2	34	Fastener, Wood, economy	UZW-4	12
Edger, Inside Corner, 2.0", SS, Comfort-Soft	T-EI2CS	31	Fastener, Wood, economy	UZW-5	12
Edger, Inside Corner, 3/4", SS, Comfort-Soft	T-EI75CS	31	Fastener, Wood/lite metal	UWLM-1	12
Edger, Inside Corner, 3/4", SS, Comfort-Soft	T-EI75RCS	33	Fastener, Wood/lite metal	UWLM-2	12
Edger, Inside Corner, 3/4", SS, Wood	T-EI75	34	Fastener, Wood/lite metal	UWLM-3	12
Edger, Inside Corner, SS, Comfort-Soft Kit	T-EIKITCS	31	Fastener, Wood/lite metal	UWLM-4	12
Edger, Inside Corner, SS, Wood, Kit	T-EIKIT	34	Fastener, Wood/lite metal	UWLM-5	12
Edger, Outside Corner, 1", SS, Comfort-Soft	T-EI1CS	31	Fastener, Wood/lite metal	UWLM-7	12
Edger, Outside Corner, 1", SS, Comfort-Soft	T-EI1RCS	33	Fastener, Wood/lite metal	UWLM-8	12
Edger, Outside Corner, 1", SS, Wood	T-EI1	34	Fastener, Wood/lite metal, economy	UZWLM-1	12
Edger, Outside Corner, 1.5", SS, Comfort-Soft	T-EI15CS	31	Fastener, Wood/lite metal, economy	UZWLM-2	12
Edger, Outside Corner, 1-1/2", SS, Comfort-Soft	T-EI15RCS	33	Fastener, Wood/lite metal, economy	UZWLM-3	12
Edger, Outside Corner, 1-1/2", SS, Wood	T-EI15	34	Fastener, Wood/lite metal, economy	UZWLM-4	12
Edger, Outside Corner, 2.0", SS, Comfort-Soft	T-EI2CS	31	Fastener, Wood/lite metal, economy	UZWLM-5	12
Edger, Outside Corner, 2.0", SS, Comfort-Soft	T-EI2RCS	33	Fine Adjustment Tool, Jamb Jack	W-CBR16	77
Edger, Outside Corner, 2.0", SS, Wood	T-EI2	34	Flashing Tape, 12" x 100'	W-PWDT12	26, 70
Edger, Outside Corner, 3/4", SS, Comfort-Soft	T-E75CS	31	Flashing Tape, 12" x 100'	W-PWDT12	45

Description	Part Code	Page	Description	Part Code	Page
Flashing Tape, 4" x 100'	W-PWDT4	26, 70	Folding G-Saw, Tajima, Replacement Blade	W-TJGBLADE	75
Flashing Tape, 4" x 100'	W-PWDT4	45	Froth-Pak 12, Sealant, 1 Kit	W-IFRPK12	82
Flashing Tape, 6" x 100'	W-PWDT6	26, 70	Froth-Pak 12, Sealant, Case of 12 Kits	W-FRPK12	82
Flashing Tape, 6" x 100'	W-PWDT6	45	Froth-Pak 160 Slow Rise Foam Kit	W-FP160SR	68, 82
Flashing Tape, 9" x 100'	W-PWDT9	26, 70	Froth-Pak 160 Slow Rise Foam Kit	W-FP160SR	82
Flashing Tape, 9" x 100'	W-PWDT9	45	Froth-Pak 180, Insulation Kit, Class A	W-FP200CA	68, 82
Float, ABS, 5-1/4" x 11-3/4"	T-PFWHITECS	39	Froth-Pak 180, Sealant Kit	W-FRPK180	68, 82
Float, Italian, 2" x 11", PVC, White	T-PF286	39	Froth-Pak 600, Insulation Kit, Class A	W-FP620CA	82
Float, Italian, 5" x 11", PVC, White	T-PF2813	39	Froth-Pak 600, Sealant Kit	W-FP600	82
Float, Neoprene, 4" x 12" x 1/2", Brown, Hard	T-NF412	40	Gloves, Rubber Coated Knit, 10 pack	W-10CG	50
Float, Neoprene, 5" x 12" x 1/2", Brown, Hard	T-NF512	40	Grappler accessory attacher	I-GRP48	74
Float, Neoprene, 5" x 12" x 1/8", Hard	T-FNEO	40	Great Stuff Pro, Gaps & Cracks, gun foam, 24 oz.	W-GSGC24	69, 80
Float, Plastic, 1-1/2" x 6-1/4", Medium	T-PFM164	39	Great Stuff Pro, Gaps & Cracks, gun foam, 30 oz.	W-GSGC30	69, 80
Float, Plastic, 2" x 11", Medium	T-PFM285	39	Great Stuff, reusable straw foam, 24 oz.	W-GSGCRS24	69, 80
Float, Plastic, 2-3/4" x 11", Medium	T-PFM287	39	Great Stuff, reusable straw foam, 30 oz.	W-GSGCRS26	69, 80
Float, Plastic, 2-3/4" x 4", Medium	T-PFM107	39	Great Stuff Pro, Gun Cleaner	W-GCCS	80
Float, Plastic, 3-1/2" x 9-1/2", Medium	T-PFM249	39	Great Stuff Pro, Wall and Floor Adhesive	W-GSWF30	80
Float, Plastic, 3-1/8" x 6-1/4", Medium, Pointed	T-PFM168SP	39	Great Stuff Pro, Window and Door, gun foam	W-GSWD	80
Float, Plastic, 3-1/8" x 6-1/4", Medium	T-PFM168	39	Great Stuff Pro, Window and Door, reusable straw foam	W-GSWDRS20	80
Float, Plastic, 4", Round	T-PFM100	39	Great Stuff Pro, Window and Door, straw foam	W-GSTWD	80
Float, Plastic, Mini Kit	T-PFMNCK	39	Groove Tool Handle, Comfort-Soft	GT-HANDLECS	19
Float, Rounded, NKI, 5" x 11"	W-F400R	39	Groove Tool Handle, wood	GT-HANDLE	19
Float, Sponge, 4" x 12" x 1/2", Red, Hard	T-RF41212	40	Grout Bag, Disposable plastic	T-GBD	52
Float, Sponge, 5" x 12" x 1", Green, Hard	W-GSF	40	Grout Bag, Poly	T-GBP	53
Float, Sponge, 5" x 12" x 1", White, Medium	W-WSF	40	Hammer Tacker Kit, R11	T-KHTR11	13, 84
Float, Sponge, 5" x 12" x 3/4", Green, Hard	W-GSF34	40	Hammer Tacker Kit, R19	T-KHTR19	13, 84
Float, Texture, 5" x 11", Plastic	T-PFTAN	38	Hammer Tacker, 1/4" staples, box	T-STHT1/4	13, 53
Float, Texture, 5" x 11", Plastic, Custom logo	T-LPFTAN	38	Hammer Tacker, 1/4" staples, case	T-STHT50	13
Float, Texture, 5-1/4" x 11", Plastic	T-PFP	38	Hammer Tacker, 3/8" staples, box	T-STHT3/8	13
Float, Texture, 5-1/4" x 11", Plastic	T-PFW	38	Hammer Tacker, 5/16" staples, box	T-STHT5/16	13
Float, Texture, 5-1/4" x 11-3/4"	T-PFWHITE	38	Hammer Tacker, R11	T-HTRR11	13, 53
Foam 2 Foam Adhesive Foam, convenience kit	W-CLF2F	58	Hammer Tacker, R19	T-HTRR19	13
Foam Gun	W-EG13	21, 59	Hammer Tacker, R19 1/4" staples, box	T-STHT19	13
Foam Gun, Brass Tips	W-EG14BT	21, 59	Hard wire benders	W-HWB	15, 62
Foam Gun, Long nozzle	W-EG14L	21, 59	Hard wire cutter	T-HWC63	15, 62
Foam Gun, Pageris	W-EG15	21, 59	Hawk, Aluminum, 10" x 10", DuraSoft	T-HP10	41
Foam Gun, Taper Tip	W-EG13T	21, 59	Hawk, Aluminum, 12" x 12", DuraSoft	T-HP12	41
Foam Gun, with Teflon tip	W-EG14	21, 59	Hawk, Aluminum, 13" x 13", DuraSoft	T-HP13	41
Foam Tacs	ARROW-TAC	11	Hawk, Aluminum, 13" x 13", Wood	T-KH13	41
Foam Tacs	INSUL-TAC	11	Hawk, Aluminum, 13" x 13", Wood	T-H13	41
Foam Tacs	M-TT1	11	Hawk, Aluminum, 13-1/2" x 13-1/2", DuraSoft	T-HP135	41
Foam Tacs	M-TT158	11	Hawk, Aluminum, 14" x 14", Wood	T-KH14	41
Foam Tacs	TRIM-TAC	11	Hawk, Magnesium, 12" x 12", Wood	T-KHM12	41
Foam2Foam Adhesive Foam, case	W-F2F24	20, 58, 69	Hawk, Magnesium, 13" x 13", DuraSoft	T-HM13	41
Foam2Foam Adhesive Foam, contractor choice kit, 11 cans	W-CCV11	58	Hawk, Magnesium, 13" x 13", Wood	T-KHM13	41
Foam2Foam Adhesive Foam, contractor choice kit, 9 cans	W-CC9	58	Hawk, Magnesium, 14" x 14", DuraSoft	T-HM14	41
Foam2Foam Adhesive Foam, convenience kit	W-CLF2F	20	Hawk, Magnesium, 14" x 14", Wood	T-KHM14	41
Foam2Foam Adhesive Foam, sampler kit	W-F2FKIT	58	Hoe, Mortar	T-HM7	53
Foam2Foam gun cleaner, case	W-PGCS	20	Hoe, Short handled	T-HM65	53
Foam2Foam Gun Cleaner, case	W-PGCS	58, 69	Home Slicker Stone & Stucco Plus Typar rainscreen, 10 mil	W-HS10PT	24, 55, 85
Foam2Foam sliver kit	W-ESK	20	Home Slicker Stone & Stucco Plus Typar rainscreen, 6 mil	W-HSPT	24, 55, 85
Foam2Foam, Contractor's Choice kit	W-CCV11	20			
Folding G-Saw, Tajima	W-TJGSAW	75			

Description	Part Code	Page	Description	Part Code	Page
Home Slicker Stone & Stucco rainscreen, 10 mil	W-HS10ST	24, 53, 55, 85	Kickout Diverter, polypropylene, white, right	W-PKORW	25, 84
Home Slicker Stone & Stucco rainscreen, 6 mil	W-HSST	24, 53, 55, 85	Lath-Lock plates	LATH-LOCK	11
Hopper Gun, 2 Gallon	W-SHG	43	Lath-Plate, legless plates	LATH-PLATE	11
Hot Knife Concrete Forms Kit	2-ICFKIT	14, 60	Ledger Connector, Composite Wood	W-ICFVLCW	64
Hot Knife Concrete Forms Kit, Gatemouh Jr.Tool bag	2-BICFKIT	14, 60	Ledger Connector, Steel	W-ICFVL	64
Hot Knife Tool Kit	2-QC	14, 60	Ledger Connector, Wood	W-ICFVLW	64
Hot Knife Tool Kit with 6" sled	2-QCKIT	14	Long-lock, wood/lite metal/masonry	WLM-7	10
Hot Knife Tool Kit with 6" sled, Gatemouh Jr.Tool bag	2-BQCKIT	14	Long-lock, wood/lite metal/masonry	WLM-8	10
Hot Knife Tool Kit, Gatemouh Jr.Tool bag	2-BQC	14, 60	Long-lock, wood/lite metal/masonry	WLM-9	10
Hot Knife, 6" Groove Sled	Q-SLED6	62	Long-lock, wood/lite metal/masonry	WLM-10	10
Hot Knife, SIP Kit	2-SIPKIT	69	Long-lock, wood/lite metal/masonry	WLM-11	10
Hot Knife, SIP Kit with Gatemouh Jr.Tool bag	2-BSIPKIT	69	Long-lock, wood/lite metal/masonry	WLM-12	10
Hot Wire Accessory, 100' Nichrome 80 Wire	I-DHW100	47, 75	Long-lock, wood/lite metal/masonry	WLM-13	10
Hot Wire Accessory, 4' Gator cord	W-DGC	47, 75	Long-lock, wood/lite metal/masonry	WLM-14	10
Hot Wire Accessory, Magnum controller	W-MAGC	47, 75	Long-lock, wood/lite metal/masonry	WLM-15	10
Hot Wire Cutter, Block Buddy with Magnum	W-MBLKB	46	Masonry drill bit, 3/16" x 14", carbide	5000025	13
Hot Wire Cutter, JobCut	W-JBC	46	Masonry drill bit, 3/16" x 14", Straight Shank, carbide	5000026	13
Hot Wire Cutter, JobCut with Magnum	W-MJBC	46	Masonry drill bit, 5/16" x 12" SCS	M-S1612	13
Hot Wire Cutter, SideWinder, 4' with Magnum	W-MSW4	47	Masonry drill bit, 5/16" x 6" SCS	M-S166	13
Hot Wire Cutter, StyroCut with Magnum	W-MCSTY	47	Masonry drill bit, 5/32" x 3-1/2", carbide	M-PKMDB35	13
Hot Wire Kit	M-DHW100	47, 75	Masonry drill bit, 5/32" x 4" SCS	M-S324	13
ICF Deck Chair, Rebar #3-#8	I-IDCU	71	Masonry drill bit, 5/32" x 4-1/2", carbide	M-PKMDB45	13
ICF Deck Chair, Universal	I-CDC15	71	Masonry drill bit, 5/32" x 5-1/2", carbide	M-PKMDB55	13
ICF Super Groover	I-ICFSG	60, 69	Masonry drill bit, 5/32" x 7" SCS	M-S327	13
ICF Super Groover Blade Kit	Q-ICFBK	61	Mixing Blade, 23-1/2" x 6-3/8" x 1/2", Galvanized	B-M1	43
ICF Super Groover Kit	I-ICFSGKIT	60, 69	Mixing Blade, 24" x 5" x 3/8", 2 Fixed wheels	TR-FBM2	43
ICF Super Groover, Ultimate Kit	I-UICFSGKIT	60	Mixing Blade, 28" x 7-1/2" x 7/16", Inverted	B-MAD	43
ICF Wallbrator	W-IWVB	72	Mixing Blade, 29" x 8-1/2" x 3/8", Square Twisted	B-MTW	43
Insta-Stick Adhesive, Single Kit	W-ISTKK	82	Mixing Blade, 30" x 8-1/2" x 5", Square	B-MSQ	43
Insta-Stick Adhesive, Tank	W-ISTKT	82	Mixing Blade, 32" x 7-1/2" x 1/2", Inverted	B-MEW	43
Insul-Knife multipurpose kit	W-INSULKIT	17, 75, 84	Mono-Brace Foldaway ICF Bracing System, 10' x 5" x 2.75"	W-BR10	76
Insul-Knife sharpener	W-INSULS	17, 75, 84	Mono-Brace Foldaway ICF Bracing System, 12' x 5" x 2.75"	W-BR12	76
Jamb Jack Kit, long	W-JJRL	77	Mono-Brace Foldaway ICF Bracing System, 8' x 5" x 2.75"	W-BR8	76
Jamb Jack Kit, short	W-JJRS	77	Mono-Brace Foldaway ICF Bracing System, 9' x 5" x 2.75"	W-BR9	76
Kickout Diverter, aluminum, beige right	W-KODRB	25	Panel Adaptor, Jamb Jack	W-JJPA	77
Kickout Diverter, aluminum, beige, left	W-KODLB	25	PermaLath glass fiber lath, 1/4"	I-PL1000	54
Kickout Diverter, aluminum, gray, left	W-KODLG	25	PermaLath glass fiber lath, 1/8"	I-PL	54
Kickout Diverter, aluminum, gray, right	W-KODRG	25	Plate Liner, 3-1/2" x 25'	W-PL35	70
Kickout Diverter, aluminum, left	W-KODL	25	Plate Liner, 5-1/2" x 25'	W-PL55	70
Kickout Diverter, aluminum, right	W-KODR	25	Rasp Kit, 4" & 6" x 14", Steel, #12 tungsten grit	T-DRK46	29
Kickout Diverter, aluminum, white, left	W-KODLW	25	Rasp Kit, 2" & 6" x 14", SS	I-IIUGZK26	27, 75
Kickout Diverter, aluminum, white, right	W-KODRW	25	Rasp Kit, 2" & 6" x 14", Steel, #12 tungsten grit	T-DRK26	29
Kickout Diverter, polypropylene, bronze, left	W-PKOLBZ	25, 84	Rasp Kit, 4" & 6" x 14", #12 tungsten grit, cut-off saw	T-TCK46	29
Kickout Diverter, polypropylene, bronze, right	W-PKORBZ	25, 84	Rasp Paper, 2" x 14" sheet, Adhesive backed, 12 grit	12-IRPA2	28
Kickout Diverter, polypropylene, brown, left	W-PKOLB	25, 84	Rasp Paper, 2" x 14" sheet, Adhesive backed, 16 grit	I-IPA2	28
Kickout Diverter, polypropylene, brown, right	W-PKORB	25, 84	Rasp Paper, 2" x 25 YD Roll, Adhesive, 12 grit	12-AROLL2	28
Kickout Diverter, polypropylene, gray, left	W-PKOLG	25, 84	Rasp Paper, 2" x 25 YD Roll, Adhesive, 16 grit	I-AROLL2	28
Kickout Diverter, polypropylene, gray, right	W-PKORG	25, 84	Rasp Paper, 2" x 50 YD Roll, Non-Adhesive, 12 grit	12-IROLL2	28
Kickout Diverter, polypropylene, sand, left	W-PKOLS	25, 84	Rasp Paper, 2" x 50 YD Roll, Non-Adhesive, 16 grit	I-ROLL2	28
Kickout Diverter, polypropylene, sand, right	W-PKORS	25, 84	Rasp Paper, 4" x 14" sheet, Adhesive backed, 12 grit	12-IRPA4	28
Kickout Diverter, polypropylene, tan, left	W-PKOLT	25, 84			
Kickout Diverter, polypropylene, tan, right	W-PKORT	25, 84			
Kickout Diverter, polypropylene, white, left	W-PKOLW	25, 84			

Description	Part Code	Page	Description	Part Code	Page
Rasp Paper, 4" x 14" sheet, Adhesive backed, 16 grit.....	I-RPA4.....	28	Simpson Titen HD Screw, 5/8" x 6".....	THD-62600H.....	66
Rasp Paper, 4" x 25 YD Roll, Adhesive, 12 grit.....	12-AROLL4.....	28	Simpson Titen HD Screw, 5/8" x 6-1/2".....	THD-62612H.....	66
Rasp Paper, 4" x 25 YD Roll, Adhesive, 16 grit.....	I-AROLL4.....	28	Simpson Truss Connectors, H Seismic Tiedown.....	W-H16S.....	66
Rasp Paper, 4" x 50 YD Roll, Non-Adhesive, 12 grit.....	12-IROLL4.....	28	Simpson Truss Connectors, H Seismic Tiedown.....	W-HM9KT.....	66
Rasp Paper, 4" x 50 YD Roll, Non-Adhesive, 16 grit.....	I-ROLL4.....	28	Simpson Truss Connectors, Hurricane Gusset Angle.....	W-HGAM10KT.....	66
Rasp Paper, 6" x 14" sheet, Adhesive backed, 12 grit.....	12-IRPA6.....	28	SIP Screw Bit, Square Drive, 3 pack.....	W-SIPBIT.....	68
Rasp Paper, 6" x 14" sheet, Adhesive backed, 16 grit.....	I-RPA6.....	28	SIP Screw Bit, Star Drive, 6 pack.....	M-PBT303.....	68
Rasp Paper, 6" x 25 YD Roll, Adhesive, 12 grit.....	12-AROLL6.....	28	SIP/ICF Screws, 10", 250 pack.....	W-SIP010.....	68
Rasp Paper, 6" x 25 YD Roll, Adhesive, 16 grit.....	I-AROLL6.....	28	SIP/ICF Screws, 11", 250 pack.....	W-SIP011.....	68
Rasp Paper, 6" x 50 YD Roll, Non-Adhesive, 12 grit.....	12-IROLL6.....	28	SIP/ICF Screws, 12", 250 pack.....	W-SIP012.....	68
Rasp Paper, 6" x 50 YD Roll, Non-Adhesive, 16 grit.....	I-ROLL6.....	28	SIP/ICF Screws, 13", 250 pack.....	W-SIP013.....	68
Rasp Paper, 8" x 16" sheet, Adhesive backed, 12 grit.....	12-IRPA86.....	28	SIP/ICF Screws, 14", 250 pack.....	W-SIP014.....	68
Rasp Paper, 8" x 16" sheet, Adhesive backed, 16 grit.....	I-RPA86.....	28	SIP/ICF Screws, 15", 250 pack.....	W-SIP015.....	68
Rasp Paper, 8" x 18" sheet, Adhesive backed, 12 grit.....	12-IRPA88.....	28	SIP/ICF Screws, 16", 250 pack.....	W-SIP016.....	68
Rasp Paper, 8" x 18" sheet, Adhesive backed, 16 grit.....	I-RPA88.....	28	SIP/ICF Screws, 4" 250 pack.....	W-SIP004.....	68
Rasp Paper, 8" x 25 YD Roll, Adhesive, 12 grit.....	12-AROLL8.....	28	SIP/ICF Screws, 5", 250 pack.....	W-SIP005.....	68
Rasp Paper, 8" x 25 YD Roll, Adhesive, 16 grit.....	I-AROLL8.....	28	SIP/ICF Screws, 6", 250 pack.....	W-SIP006.....	68
Rasp Paper, 8" x 50 YD Roll, Non-Adhesive, 12 grit.....	12-IROLL8.....	28	SIP/ICF Screws, 7", 250 pack.....	W-SIP007.....	68
Rasp Paper, 8" x 50 YD Roll, Non-Adhesive, 16 grit.....	I-ROLL8.....	28	SIP/ICF Screws, 8", 250 pack.....	W-SIP008.....	68
Rasp, 2" x 14", Aluminum, Sanding.....	I-SR2.....	28	SIP/ICF Screws, 9", 250 pack.....	W-SIP009.....	68
Rasp, 2" x 14", SS, 12-14 Grit.....	I-IIUGZ2.....	27, 75	Sponge, Cellulose.....	T-GCS.....	48
Rasp, 2" x 14", Steel, #12 tungsten grit.....	T-DR2.....	29	Sponge, Grouting.....	T-XLGS.....	48
Rasp, 5" x 14", Bull nose, #12 tungsten grit.....	T-DB514.....	29	Square Groove Blade, 1" x 1".....	KS-101.....	18
Rasp, 4" x 14", Aluminum, Sanding.....	I-SR4.....	28	Square Groove Blade, 1" x 1".....	HS-101.....	19
Rasp, 4" x 14", Plastic, Sanding.....	I-PSR4.....	28	Square Groove Blade, 1" x 1/2".....	KS-102.....	18
Rasp, 4" x 14", SS, 12-14 Grit.....	I-IIUGZ4.....	27, 75	Square Groove Blade, 1" x 1/2".....	HS-102.....	19
Rasp, 4" x 14", Steel, #12 tungsten grit.....	T-DR4.....	29	Square Groove Blade, 1" x 3/4".....	KS-103.....	18
Rasp, 4" x 14", Steel, #12 tungsten grit, cut-off saw.....	T-TC4.....	29	Square Groove Blade, 1" x 3/4".....	HS-103.....	19
Rasp, 6" x 14", Aluminum, Sanding.....	I-SR6.....	28	Square Groove Blade, 1/2" x 1/2".....	KS-502.....	18
Rasp, 6" x 14", Doublesided, #12 tungsten grit.....	T-DE614.....	29	Square Groove Blade, 1/2" x 1/2".....	HS-502.....	19
Rasp, 6" x 14", Plastic, Sanding.....	I-PSR6.....	28	Square Groove Blade, 1-1/2" x 1".....	KS-151.....	18
Rasp, 6" x 14", SS, 12-14 Grit.....	I-IIUGZ6.....	27, 75	Square Groove Blade, 1-1/2" x 1".....	HS-151.....	19
Rasp, 6" x 14", Steel, #12 tungsten grit.....	T-DR6.....	29	Square Groove Blade, 1-1/2" x 1/2".....	KS-152.....	18
Rasp, 6" x 14", Steel, #12 tungsten grit, cut-off saw.....	T-TC6.....	29	Square Groove Blade, 1-1/2" x 1/2".....	HS-152.....	19
Rasp, 8" x 14", SS, 12-14 Grit.....	I-IIUGZ8.....	27, 75	Square Groove Blade, 1-1/2" x 3/4".....	KS-153.....	18
Rasp, 8" x 14", Steel, #12 tungsten grit.....	T-DR8.....	29	Square Groove Blade, 1-1/2" x 3/4".....	HS-153.....	19
Rasp, 8" x 14", Steel, #12 tungsten grit, cut-off saw.....	T-TC8.....	29	Square Groove Blade, 2" x 1".....	KS-201.....	18
Rasp, 8" x 16", Aluminum, Sanding.....	I-SR8.....	28	Square Groove Blade, 2" x 1".....	HS-201.....	19
Rasp, 8" x 18", Pneumatic.....	I-PAR.....	28	Square Groove Blade, 2" x 3/4".....	KS-203.....	18
Rasp, knockdown, 2' Aluminum, serrated edge.....	HDS-2.....	28	Square Groove Blade, 2" x 3/4".....	HS-203.....	19
Rasp, knockdown, 4' Aluminum, serrated edge.....	HDS-4.....	28	Square Groove Blade, 3/4" x 1/2".....	KS-752.....	18
Rasp, knockdown, 6' Aluminum, serrated edge.....	HDS-6.....	28	Square Groove Blade, 3/4" x 1/2".....	HS-752.....	19
Rasp, toothed, 4" x 14", SS, 12-14 Grit.....	I-IITUGZ4.....	27	Square Groove Blade, 3/4" x 3/4".....	KS-753.....	18
Rasp, toothed, 4" & 6" x 14".....	I-IITUGZ46.....	27, 75	Square Groove Blade, 3/4" x 3/4".....	HS-753.....	19
Rasp, toothed, 6" x 14", SS, 12-14 Grit.....	I-IITUGZ6.....	27	Square Groove Sled, 1" x 1".....	GSS-101.....	19
Rasp, toothed, 8" x 14", SS, 12-14 Grit.....	I-IITUGZ8.....	27	Square Groove Sled, 1" x 1/2".....	GSS-102.....	19
Rebar Bender and Cutter.....	W-RCB.....	71	Square Groove Sled, 1" x 3/4".....	GSS-103.....	19
Reload Reel.....	T-RRY.....	53	Square Groove Sled, 1/2" x 1/2".....	GSS-502.....	19
Scarifier, Plastic, 12".....	T-PLSC16.....	41	Square Groove Sled, 1-1/2" x 1".....	GSS-151.....	19
Scraper, Japan, SS, 4 PC Kit.....	T-JT3290K.....	37	Square Groove Sled, 1-1/2" x 1/2".....	GSS-152.....	19
Sill Sealer, 3-1/2" x 25' x 3/8".....	W-PSS35.....	70	Square Groove Sled, 1-1/2" x 3/4".....	GSS-153.....	19
Sill Sealer, 5-1/2" x 25' x 3/8".....	W-PSS55.....	70	Square Groove Sled, 2" x 1".....	GSS-201.....	19
Simpson Titen HD Screw, 1/2" x 6".....	THD-50600H.....	66	Square Groove Sled, 2" x 3/4".....	GSS-203.....	19

Description	Part Code	Page	Description	Part Code	Page
Square Groove Sled, 3/4" x 1/2"	GSS-752	19	Tape, Filament, 2" x 60 YD	W-FT2	44, 73
Square Groove Sled, 3/4" x 3/4"	GSS-753	19	Tape, Masking, Blue, 1" x 60 YD	W-BMT1	44
Starter Trac, casing bead, 1" x 10' with weep holes	WST-1WP	23	Tape, Masking, Blue, 1-1/2" x 60 YD	W-BMT15	44
Starter Trac, casing bead, 1" x 8'	WST-1	23	Tape, Masking, Blue, 2" x 60 YD	W-BMT2	44
Starter Trac, casing bead, 1" x 10'	WST10-1	23	Tape, Stucco, Black, 2" x 60 YD	W-BKT2	44
Starter Trac, casing bead, 1" x 8' with weep holes	WST8-1WP	23	Tape, Stucco, Red, 2" x 60 YD	W-SRT2	32, 44
Starter Trac, casing bead, 1/2" x 10' with weep holes	WSTWP-50	23	Tape, Stucco, Black, 4" x 60 YD	W-BKT4	44
Starter Trac, casing bead, 1-1/2" x 10'	WST10-15	23	Tape, Stucco, Red, 4" x 60 YD	W-SRT4	32, 44
Starter Trac, casing bead, 1-1/2" x 10' with weep holes	WST-15WP	23	Tek Screws, 1/4"—14 x 3/4", Medium Duty, 100	UTMD1147-PK	64
Starter Trac, casing bead, 1-1/2" x 8'	WST-15	23	Tek Screws, 1/4"—14 x 3/4", Medium Duty, 1000	UT-MD1147	64
Starter Trac, casing bead, 1-1/2" x 8' with weep holes	WST8-15WP	23	Tek Screws, 1/4"—28 x 3", Heavy Duty, 120 PC	W-ICFD3	64
Starter Trac, casing bead, 2" x 10'	WST10-2	23	Telescoping Heavy Wall Kit, Tall Wall, 14' x 3' x 5.5'	W-BRTWL	76
Starter Trac, casing bead, 2" x 10' with weep holes	WST-2WP	23	Towel, smoothing, 5-1/8" x 19-3/4", SS, wood	T-STA	37
Starter Trac, casing bead, 2" x 8'	WST-2	23	Transition Wrap	W-PIW12	70
Starter Trac, casing bead, 2" x 8' with weep holes	WST8-2WP	23	Transition wrap primer	W-STP	26, 70
Starter Trac, casing bead, 2-1/2" x 10'	WST10-25	23	Trowel, 11" x 4-3/4", Venetian, SS, Comfort-Soft	T-VPF2812	30
Starter Trac, casing bead, 2-1/2" x 10' with weep holes	WST10-25WP	23	Trowel, 11" x 4-3/4", Venetian, SS, Comfort-Soft	T-VT28012	30
Starter Trac, casing bead, 2-1/2" x 8'	WST-25	23	Trowel, 1-1/2" x 3-5/8", Margin, SS, Comfort-Soft	T-M358CS	31
Starter Trac, casing bead, 3" x 10' with weep holes	WST10-3WP	23	Trowel, 1-1/2" x 7", Margin, SS, Comfort-Soft	T-M7CS	31
Starter Trac, casing bead, 3" x 8'	WST-3	23	Trowel, 11-1/2" x 4-3/4", Plastering, SS, Comfort-Soft	T-115CS	30
Starter Trac, casing bead, 3/4" x 10' with weep holes	WST-75WP	23	Trowel, 12" x 4-3/4", Plastering, SS, Comfort-Soft	T-12CS	30
Starter Trac, casing bead, 3/4" x 8' with weep holes	WST8-75WP	23	Trowel, 13" x 4-3/4", Plastering, SS, Comfort-Soft	T-13CS	30
Starter Trac, casing bead, 4" x 10'	WST10-4	23	Trowel, 14" x 4-3/4", Plastering, SS, Comfort-Soft	T-14CS	30
Starter Trac, casing bead, 4" x 10' with weep holes	WST10-4WP	23	Trowel, 16" x 4-3/4", Plastering, SS, Comfort-Soft	T-16CS	30
Starter Trac, casing bead, 7/8" x 10' with weep holes	WST-78WP	23	Trowel, 2" x 5-1/2", Margin, SS, Comfort-Soft	T-M55CS	31
Starter Trac, drip edge weep holes, 1" x 10'	WSTDE10-1	23	Trowel, 20", E-Z Kit	T-EZ3K20	37
Starter Trac, drip edge weep holes, 1" x 8'	WSTDE-1	23	Trowel, 20", Inner Curve, E-Z	T-EZC20	37
Starter Trac, drip edge weep holes, 1-1/2" x 10'	WSTDE10-15	23	Trowel, 20", Outer Curve, E-Z	T-EZO20	37
Starter Trac, drip edge weep holes, 1-1/2" x 8'	WSTDE-15	23	Trowel, 20", Straight, E-Z	T-EZ20	37
Starter Trac, drip edge weep holes, 2" x 10'	WSTDE10-2	23	Trowel, 26", E-Z Kit	T-EZ3K26	37
Starter Trac, drip edge weep holes, 2" x 8'	WSTDE-2	23	Trowel, 26", Inner Curve, E-Z	T-EZC26	37
Starter Trac, drip edge weep holes, 2-1/2" x 8'	WSTDE-25	23	Trowel, 26", Outer Curve, E-Z	T-EZO26	37
Starter Trac, drip edge weep holes, 3" x 10'	WSTDE10-3	23	Trowel, 26", Straight, E-Z	T-EZ26	37
Starter Trac, drip edge weep holes, 3" x 8'	WSTDE-3	23	Trowel, 7-3/4" x 3-1/8", Venetian, SS, Comfort-Soft	T-VPF2008	30
Starter Trac, drip edge weep holes, 3/4" x 10'	WSTDE10-75	23	Trowel, 7-7/8" x 3-1/8", Venetian, SS, Comfort-Soft	T-VT2008	30
Starter Trac, drip edge weep holes, 3/4" x 8'	WSTDE-75	23	Trowel, 9-1/2" x 4-1/4", Venetian, SS, Comfort-Soft	T-VT24011	30
Starter Trac, drip edge weep holes, 4" x 10'	WSTDE10-4	23	Trowel, 9-1/2" x 4-3/8", Venetian, SS, Comfort-Soft	T-VPF2411	30
Starter Trac, window/door, 1" x 8'	WDST-1	23	Trowel, Bucket, Small, SS, EZ Grip	T-SBTRCS	33
Starter Trac, window/door, 1-1/2" x 8'	WDST-15	23	Trowel, Bucket, SS, Comfort-Soft	T-BTSCS	42
Starter Trac, window/door, 2" x 8'	WDST-2	23	Trowel, Bucket, SS, EZ Grip	T-BTRSCS	33
Step-up and down transformer	I-TS4033	15, 62	Trowel, Bucket, SS, Wood	T-BTS	42
Stone Nipper, 14"	T-STN	52	Trowel, Curry, Finishing, 4-1/2" x 11", SS, Wood	T-C4511	35
Stone Veneer Kit	W-STVK	52	Trowel, Curry, Finishing, 4-1/2" x 11-1/2", SS, Wood	T-C45115	35
Straight Edge Attachment, Groove Sled	Q-SE	62	Trowel, Curry, Finishing, 4-3/4" x 11-1/2", SS, Wood	T-C47115	35
Stretch Wrap, 18" x 1500'	W-SW18	49	Trowel, Curry, Finishing, 5" x 12", SS, Wood	T-C101C	35
Stucco Rub Brick	T-RB6	52	Trowel, Curry, Finishing, 5" x 13", SS, Wood	T-C102C	35
Stucco Trims, Control Joints, 26	W-CJ75	51	Trowel, Curry, Finishing, 5" x 14", SS, Wood	T-C103C	35
Stucco Trims, Control Joints, 35	W-CJ50	51	Trowel, Curry, Finishing, 5" x 16", SS, Wood	T-CSS516C	35
Stucco Trims, Control Stops, 100	W-CBPS50	51	Trowel, Custom notched, SS, Comfort-Soft	CUSTOM-DNC12	36
Stucco Trims, Control Stops, 75	W-CBPS75	51	Trowel, Custom notched, SS, Wood	CUSTOM-12	36
Stucco Trims, Corner Beads	W-CB8	51	Trowel, Detail, Pointed, SS, Comfort-Soft	T-PDTC	31
Tape, Clear, 4"	W-CPT4	73	Trowel, Detail, Pointed, SS, Wood	T-PDT	34
Tape, Filament, 1" x 60 YD	W-FT1	44, 73	Trowel, Detail, Round, SS, Comfort-Soft	T-RDTC	31

Description	Part Code	Page	Description	Part Code	Page
Trowel, Detail, Round, SS, Wood	T-RDT	34	Trowel, Round notched, 1/2" x 1/2" x 2", SS, Comfort-Soft	T-DN122P	36
Trowel, Detail, SS, Comfort-Soft, Kit	T-DTKITCS	31	Trowel, Round notched, 1/2" x 1/2" x 2", SS, Wood	T-N122P	36
Trowel, Detail, SS, Wood, Kit	T-DTKIT	34	Trowel, Round notched, 1/4" x 1/4" x 1-1/2", SS, Comfort-Soft	T-DN1415	36
Trowel, Finishing, 4-3/4" x 11-1/2", GSS, DuraSoft, Marshalltown	T-DS115	35	Trowel, Round notched, 1/4" x 1/4" x 1-1/2", SS, Wood	T-N1415	36
Trowel, Finishing, 4-3/4" x 11-1/2", GSS, Wood, Marshalltown	T-P115	35	Trowel, Round notched, 3/16" x 1/4" x 1-1/2", SS, Comfort-Soft	T-DN31615	36
Trowel, Finishing, 5" x 12", GSS, DuraSoft, Marshalltown	T-DS12	35	Trowel, Round notched, 3/16" x 1/4" x 1-1/2", SS, Wood	T-N31615	36
Trowel, Finishing, 5" x 12", GSS, Wood, Marshalltown	T-P12	35	Trowel, Round notched, 3/16" x 3/16" x 3/16", SS, Comfort-Soft	T-DN316316	36
Trowel, Finishing, 5" x 13", GSS, DuraSoft, Marshalltown	T-DS13	35	Trowel, Round notched, 3/16" x 3/16" x 3/16", SS, Wood	T-N316316	36
Trowel, Finishing, 5" x 13", GSS, Wood, Marshalltown	T-P13	35	Trowel, Round notched, 3/16" x 3/16" x 5/8", SS, Comfort-Soft	T-DN31658	36
Trowel, Finishing, 5" x 14", GSS, DuraSoft, Marshalltown	T-DS14	35	Trowel, Round notched, 3/16" x 3/16" x 5/8", SS, Wood	T-N31658	36
Trowel, Finishing, 5" x 14", GSS, Wood, Marshalltown	T-P14	35	Trowel, Round notched, 3/16" x 3/8" x 1-3/4", SS, Comfort-Soft	T-DN31616D	36
Trowel, Finishing, 5" x 16", GSS, DuraSoft, Marshalltown	T-DS16	35	Trowel, Round notched, 3/16" x 3/8" x 1-3/4", SS, Wood	T-N31616D	36
Trowel, Finishing, 5" x 16", GSS, Wood, Marshalltown	T-P16	35	Trowel, Round notched, 3/8" x 1/2" x 1-1/2", SS, Comfort-Soft	T-DN3815	36
Trowel, Finishing, Midget, 3" x 8", GSS, Wood, Marshalltown	T-P83	35	Trowel, Round notched, 3/8" x 1/2" x 1-1/2", SS, Wood	T-N3815	36
Trowel, Inside Corner, 4", SS, Wood	T-CTIS	34	Trowel, Round notched, 3/8" x 1/4" x 1-1/2", SS, Comfort-Soft	T-DN381415	36
Trowel, Margin, 1-1/2" x 3-5/8", SS, Wood	T-M358	34	Trowel, Round notched, 3/8" x 1/4" x 1-1/2", SS, Wood	T-N381415	36
Trowel, Margin, 1-1/2" x 5", CRS, Comfort-Soft	T-M515CS	31	Trowel, Round notched, 5/16" x 5/16" x 3/4", SS, Comfort-Soft	T-DN51675	36
Trowel, Margin, 1-1/2" x 5", CRS, Wood, Marshalltown	T-M515	35	Trowel, Round notched, 5/16" x 5/16" x 3/4", SS, Wood	T-N51675	36
Trowel, Margin, 1-1/2" x 7", SS, Wood	T-M7	34	Trowel, Round notched, 5/8" x 5/8" x 1", SS, Comfort-Soft	T-DN58P	36
Trowel, Margin, 2" x 5", CRS, Comfort-Soft	T-M52CS	31	Trowel, Round notched, 5/8" x 5/8" x 1", SS, Wood	T-N58P	36
Trowel, Margin, 2" x 5", CRS, Wood, Marshalltown	T-M52	35	Trowel, Square notched, 3/8" x 3/8" x 3/8", SS, Wood	T-N38	36
Trowel, Margin, 2" x 5-1/2", SS, Wood	T-M55	34	Trowel, Square notched, 5/16" x 5/16" x 5/16", SS, Wood	T-N516	36
Trowel, Margin, 2" x 6", CRS, Comfort-Soft	T-M62CS	31	Trowel, Square notched, 5/32" x 5/32" x 5/32", SS, Wood	T-N532	36
Trowel, Margin, 2" x 6", CRS, Wood, Marshalltown	T-M62	35	Trowel, Square notched, 5/8" x 5/8" x 5/8", SS, Wood	T-N58	36
Trowel, Margin, 2" x 8", CRS, Comfort-Soft	T-M82CS	31	Trowel, Square notched, 7/32" x 7/32" x 7/32", SS, Wood	T-N732	36
Trowel, Margin, 2" x 8", CRS, Wood, Marshalltown	T-M82	35	Tyvek sheathing tape	W-TST	24, 85
Trowel, Margin, CRS, Comfort-Soft, Kit	T-SMKITCS	31	Tyvek StuccoWrap	W-TSW5	24, 85
Trowel, Margin, CRS, Wood, Marshalltown, Kit	T-SMKIT	35	ULP 302, Plate	ULP-302	10
Trowel, Margin, Pointed, EZ-Grip	T-MPRCS	33	ULP 302, steel screw, 1-5/8"	ULP-3S1	10
Trowel, Margin, SS, Comfort-Soft, Kit	T-SSMKITCS	31	ULP 302, steel screw, 2"	ULP-3S2	10
Trowel, Margin, SS, Wood, Kit	T-SSMKIT	34	ULP 302, steel screw, 2 -5/8"	ULP-3S3	10
Trowel, Ornamental Kit	T-OTKIT	37	ULP 302, steel screw, 3"	ULP-3S4	10
Trowel, Ornamental, 10 MM	T-OT10	37	ULP 302, steel screw, 3"	ULP-3S5	10
Trowel, Ornamental, 16 MM	T-OT16	37	ULP 302, wood/lite metal screw, 2"	ULP-3WLM2	10
Trowel, Ornamental, 20 MM	T-OT20	37	ULP 302, wood/lite metal screw, 2-1/2"	ULP-3WLM3	10
Trowel, Ornamental, 26 MM	T-OT26	37	ULP 302, wood/lite metal screw, 3"	ULP-3WLM4	10
Trowel, Ornamental, 30 MM	T-OT30	37	ULP 302, wood/lite metal screw, 4"	ULP-3WLM5	10
Trowel, Outside Corner, 4", SS, Wood	T-CTOS	34	ULP 302, wood/lite metal screw, 1-5/8"	ULP-3WLM1	10
Trowel, Pavan, Plastic, Aluminum Support, 11" x 5.12"	T-PVRA280	38	ULP 402 Plates	ULP-402	10
Trowel, Pavan, Plastic, Aluminum Support, 7.87" x 3.15"	T-PVRA200	38	Ultimate EIFS Hot Knife Fabricator Kit	2-UEIFSKIT	14
Trowel, Pavan, Plastic, Plastic, 11" x 5.12"	T-PVR280	38	Universal depth stop	M-UNIV	13
Trowel, Pavan, Plastic, Plastic, 9.45" x 3.45"	T-PVR240	38	Universal Starter Track, 10'	W-UST10	22
Trowel, Pavan, 7.88" x 3.15", trapezoid	T-P200CS	30	Universal Starter Track, 8'	W-UST	22
Trowel, Pavan, 9.45" x 3.94", trapezoid	T-P240CS	30	Universal Stirrup Bender	W-XTC	71
Trowel, Pipe, CRS, Comfort-Soft	T-PTCS	31	Utility Blade, breakaway, 50 pack	I-50PK	17
Trowel, Plastering, SS, EZ Grip	T-13RCS	33	Utility Blade, KDS, 1" heavy duty blade, 10 pack	I-SDH10PK	17
Trowel, Pool, 10" x 3", SS, Wood, Kraft	T-KPL10	35	Utility Blade, KDS, 1" heavy duty blade, 50 pack	I-HD50PK	17
Trowel, Pool, 12" x 3-1/2", SS, Wood, Kraft	T-KPL12	35			
Trowel, Pool, 14" x 4", SS, Wood, Kraft	T-KPL14	35			
Trowel, Pool, 16" x 4", SS, Wood, Kraft	T-KPL16	35			
Trowel, Round notched, 1/2" x 1/2" x 1/2", SS, Wood	T-N1212	36			

Description	Part Code	Page	Description	Part Code	Page
Utility Blade, KDS, breakaway, 10 pack.....	I-10PK.....	17	Wind-Devil, expandable masonry screw, 7".....	MET-8.....	7
Utility Blade, KDS, heavy duty, 1", 5 pack.....	I-HD5PK.....	17	Wind-Devil, expandable masonry screw, 8".....	MET-9.....	7
Utility Knife, Heavy Duty Blades, 1", 20 pack.....	I-HD20PK.....	17	Wind-Devil, masonry, 1-3/4".....	MT-1.....	7
Utility Knife, KDS, plastic.....	I-LUK19.....	17	Wind-Devil, masonry, 2-1/4".....	MT-2.....	7
Utility Knife, KDS, Plastic, Heavy Duty.....	I-JBH12.....	17	Wind-Devil, masonry, 2-3/4".....	MT-3.....	7
Utility Knife, OLFA Plastic Knife.....	I-UK.....	17	Wind-Devil, masonry, 3-1/4".....	MT-4.....	7
Utility Knife, OLFA, Non-slip, Heavy Duty.....	I-HDUK.....	17	Wind-Devil, masonry, 4".....	MT-5.....	7
Utility Knife, OLFA, Rubber, Heavy Duty.....	I-RHDUK.....	17	Wind-Devil, steel, 1-5/8".....	ST-1.....	7
Utility Knife, Solid Blades, 10 pack.....	I-S10PK.....	17	Wind-Devil, steel, 2".....	ST-2.....	7
Utility Knife, Tajima, 1" blade.....	I-TJHDUK.....	17	Wind-Devil, steel, 2-5/8".....	ST-3.....	7
Utility Knife, Tajima, 1" rock hard breakaway blade.....	I-TJHD20PK.....	17	Wind-Devil, steel, 3".....	ST-4.....	7
Utility Knife, Tajima, 1" rock hard breakaway blade.....	I-TJHD5PK.....	17	Wind-Devil, steel, 4".....	ST-5.....	7
Utility Knife, Tajima, 3/4" blade.....	I-TJUK.....	17	Wind-Devil, steel, 4-3/8".....	ST-6.....	7
Utility Knife, Tajima, 3/4" breakaway blade, 10 pack.....	I-TJ10PK.....	17	Wind-Devil, steel, 5".....	ST-7.....	7
Utility Knife, Tajima, 3/4" breakaway blade, 50 pack.....	I-TJ50PK.....	17	Wind-Devil, steel, 6".....	ST-8.....	7
Utility Tub.....	T-CT.....	53	Wind-Devil, steel, 7".....	ST-9.....	7
V Groove Blade, 1" x 1".....	HV-101.....	19	Wind-Devil, steel, 8".....	ST-10.....	7
V Groove Blade, 1" x 1/2".....	HV-100.....	19	Wind-Devil, wood (zinc), 1-5/8".....	GWT-1.....	7
V Groove Blade, 1" x 3/4".....	HV-175.....	19	Wind-Devil, wood (zinc), 2".....	GWT-2.....	7
V Groove Blade, 1/2" x 1/2".....	HV-5050.....	19	Wind-Devil, wood (zinc), 2-5/8".....	GWT-3.....	7
V Groove Blade, 1-1/2" x 3/4".....	HV-150.....	19	Wind-Devil, wood (zinc), 3".....	GWT-4.....	7
V Groove Blade, 2" x 1".....	HV-200.....	19	Wind-Devil, wood (zinc), 4".....	GWT-5.....	7
V Groove Blade, 3/4" x 3/4".....	HV-7575.....	19	Wind-Devil, wood/lite metal, 2-5/8".....	WLMT-1.....	7, 67
V Groove Blade, 3/4" x 3/8".....	HV-75.....	19	Wind-Devil, wood/lite metal, 2".....	WLMT-2.....	7, 67
V Groove Blade Kit, 1" x 1".....	KV-101.....	18	Wind-Devil, wood/lite metal, 2-1/2".....	WLMT-3.....	7, 67
V Groove Blade Kit, 1" x 1/2".....	KV-100.....	18	Wind-Devil, wood/lite metal, 3".....	WLMT-4.....	7, 67
V Groove Blade Kit, 1" x 3/4".....	KV-175.....	18	Wind-Devil, wood/lite metal, 4".....	WLMT-5.....	7, 67
V Groove Blade Kit, 1/2" x 1/2".....	KV-5050.....	18	Wind-Devil, wood/lite metal, 5".....	WLMT-7.....	7, 67
V Groove Blade Kit, 1-1/2" x 3/4".....	KV-150.....	18	Wind-Devil, wood/lite metal, 7".....	WLMT-8.....	7, 67
V Groove Blade Kit, 2" x 1".....	KV-200.....	18	Wind-Devil, wood/lite metal (zinc), 1-5/8".....	GWLMT-1.....	7
V Groove Blade Kit, 3/4" x 3/4".....	KV-7575.....	18	Wind-Devil, wood/lite metal (zinc), 2".....	GWLMT-2.....	7
V Groove Blade Kit, 3/4" x 3/8".....	KV-75.....	18	Wind-Devil, wood/lite metal (zinc), 2-1/2".....	GWLMT-3.....	7
V Groove Sled, 1" x 1".....	GSV-101.....	19	Wind-Devil, wood/lite metal (zinc), 3".....	GWLMT-4.....	7
V Groove Sled, 1" x 1/2".....	GSV-100.....	19	Wind-Devil, wood/lite metal (zinc), 4".....	GWLMT-5.....	7
V Groove Sled, 1" x 3/4".....	GSV-175.....	19	Window and Door Bracing Kit, Jamb Jack, 36"-57" adjustable.....	W-JJS.....	77
V Groove Sled, 1/2" x 1/2".....	GSV-5050.....	19	Window and Door Bracing Kit, Jamb Jack, 53"-80" adjustable.....	W-JJM.....	77
V Groove Sled, 1-1/2" x 3/4".....	GSV-150.....	19	Window and Door Bracing Kit, Jamb Jack, 72"-108" adjustable.....	W-JJL.....	77
V Groove Sled, 2" x 1".....	GSV-200.....	19	Window Film, 12" x 200 YD.....	W-BFT12.....	45
V Groove Sled, 3/4" x 3/4".....	GSV-7575.....	19	Window Film, 2" x 200 YD.....	W-BFT2.....	45
V Groove Sled, 3/4" x 3/8".....	GSV-75.....	19	Window Film, 21" x 200 YD.....	W-BFT21.....	45
Weather Trek House Wrap.....	W-WTK.....	24, 85	Window Film, 24" x 200 YD.....	W-BFT24.....	45
Wind-Devil 2 Plates.....	WD-2PLATE.....	6, 67	Window Film, 36" x 200 YD.....	W-BFT36.....	45
Wind-Devil 2 Plates, 1 Pack of 500.....	WD2-PK.....	6, 67	Window Film, 4" x 200 YD.....	W-BFT4.....	45
Wind-Devil, expandable masonry screw, 2-1/4".....	MET-1.....	7	Window Film, 6" x 200 YD.....	W-BFT6.....	45
Wind-Devil, expandable masonry screw, 2-1/2".....	MET-2.....	7	Zip Tie, Installation Tool.....	Q-L300C.....	73
Wind-Devil, expandable masonry screw, 3".....	MET-3.....	7	Zip Ties, 24" Nylon, 50 pack.....	Q-ZIP24.....	73
Wind-Devil, expandable masonry screw, 4".....	MET-4.....	7	Zip Ties, 36" Nylon, 50 pack.....	Q-ZIP36.....	73
Wind-Devil, expandable masonry screw, 4-1/2".....	MET-5.....	7	Zip Ties, 8" Nylon, 100 pack.....	Q-ZIP8.....	73
Wind-Devil, expandable masonry screw, 5".....	MET-6.....	7			
Wind-Devil, expandable masonry screw, 6".....	MET-7.....	7			

Wind-lock®: Thinking Globally

Wind-lock® helps conserve valuable resources and minimizes environmental impact. Here are the resources we saved:



26,000 POUNDS OF WOOD:

Saving a total of 93 trees that supply enough oxygen for 46 people annually.



26,416 POUNDS OF CO₂ EMISSIONS:

Reducing the carbon sequestered by 307 tree seedlings in 10 years of growth.



85,247 GALLONS OF WATER:

Conserving enough water for 4,956 eight-minute showers.



9,853 POUNDS OF SOLID WASTE:

Equal to the amount thrown away by 2,142 people in one day.



90 MILLION BTUS OF ENERGY:

Saving enough energy to power the average American household for 1 year.

Environmental impact estimates were made using the Environmental Defense Fund Paper Calculator. Savings compared to 2009 Wind-lock® Catalog.

This paper is printed on FSC paper.



MIXED SOURCES

Product group from well-managed forests, controlled sources and recycled wood or fiber.
www.fsc.org Cert no. SCS-COC-001804
©2010 Forest Stewardship Council



We ship from 6 locations. Ask about our *stock to dock* guarantee.

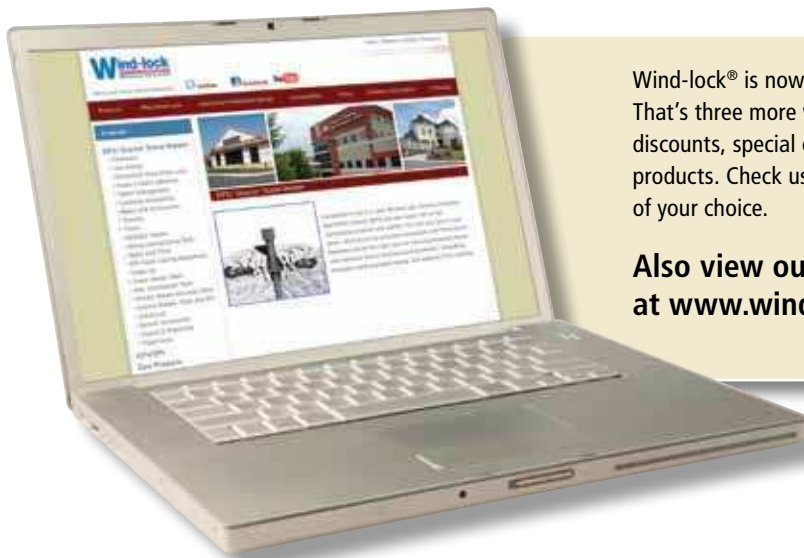

Wind-lock® is now on Twitter, Facebook and YouTube. That's three more ways for you to get a jump on great discounts, special offers and a wide range of labor-saving products. Check us out online and access the network of your choice.



**Also view our E-catalog
at www.wind-lock.com**



1055 Leisz's Bridge Road, Leesport, PA 19533
Phone: 1-800-872-5625 • Fax: 1-800-854-6614
E-mail: wlsupport@wind-lock.com • Web: www.wind-lock.com