



AccessTile[®]

Tactile Systems

**CAST-IN-PLACE REPLACEABLE
Detectable Warning Surface Panels
Submittal**



REPLACEABLE CAST IN PLACE

Introducing the **Ultimate Solution™** in Tactile Walking Surface Indicators (TWSI). Access Tile® Replaceable Cast in Place has combined proven engineered polymers, processing and material technologies with innovative and intelligent design features to create the ultimate replaceable tactile walking surface indicators. Maximized efficiencies in manufacturing, materials sourcing, and product specifications deliver the most cost-effective solution in the industry. Access Tile truncated dome and wayfinding bar tiles are the industry leader for durability, weather, and wear resistance and are available as surface-applied tiles and directional bars.

Tactile Walking Surface Indicators (TWSI) products for the following and many more applications:

- Curb Ramps
- Vehicular Passageways
- Parking Areas
- Top of Stair Landings / Wheelchair Ramps
- Pedestrian Crossings
- Escalator Approaches
- Transit Platforms
- Multi-Modal Transit Stations

PRODUCT FEATURES

- The most cost-effective method of new curb ramp applications
- A smooth transition that meets United States Accessibility Codes
- Available as a standard radius tile
- Available in eight (8) different sizes to meet your needs
- Easily cut to conform to various sizes and radius ramps
- Comes in six (6) standard colors
- Lightweight and easy to handle
- 5-year manufacturer's warranty

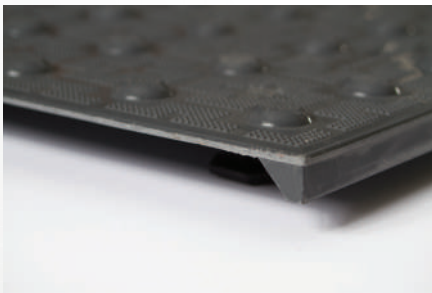

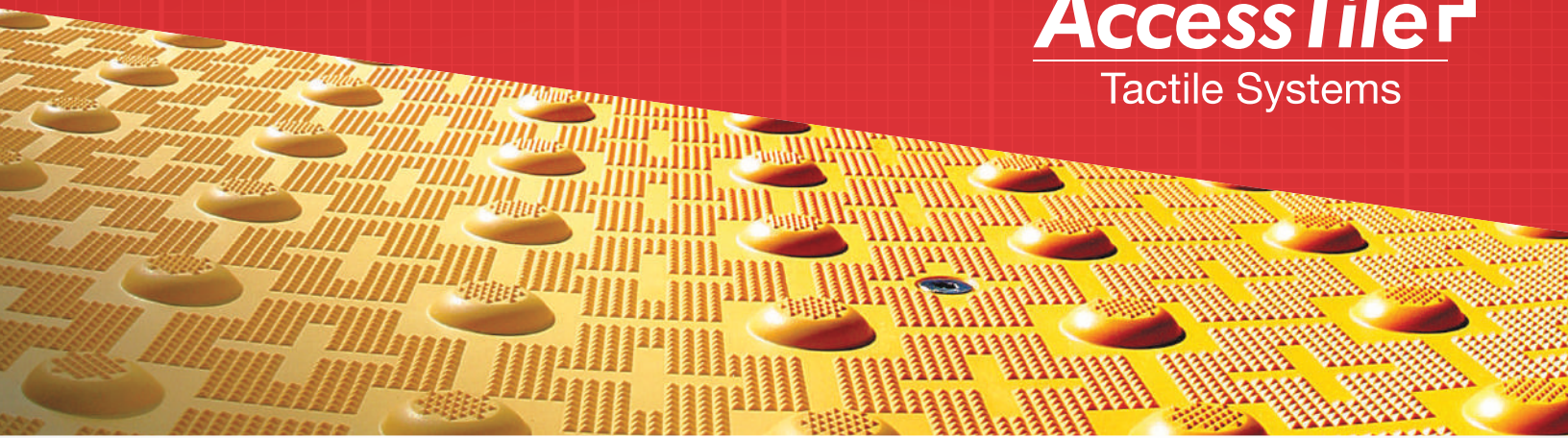

TACTILE WALKING SURFACE INDICATOR (TWSI) WITH TRUNCATED DOMES

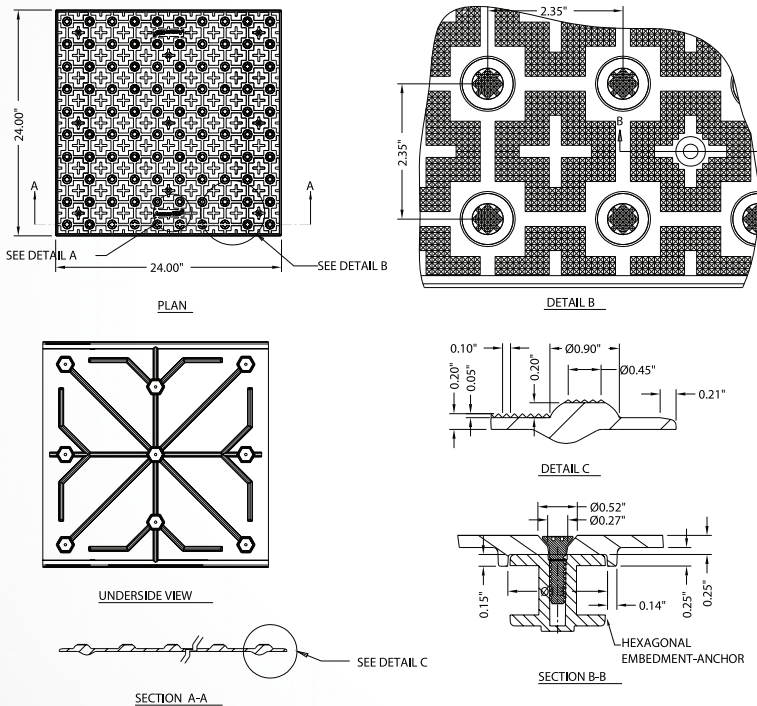

STANDARD CAST-IN-PLACE SIZES	
SIZE	PRODUCT CODE
12" x 12" (305 x 305 mm)	ACC-R-1212
24" x 24" (610 x 610 mm)	ACC-R-2424
24" x 36" (610 x 915 mm)	ACC-R-2436
24" x 48" (610 x 1220 mm)	ACC-R-2448
24" x 60" (610 x 1524 mm)	ACC-R-2460
36" x 48" (915 x 1220 mm)	ACC-R-3648
36" x 60" (915 x 1524 mm)	ACC-R-3660
RADIUS PANEL	PRODUCT CODE
24" x 30" (610 x 762 mm)	ACC-R-2430CRV

APPLICATIONS

TWSI Truncated Domes

- Curb ramps and blended transitions at pedestrian street crossings
- Pedestrian refuge islands
- Pedestrian at-grade rail crossings not located within a street or highway
- Boarding platforms at transit stops for buses and rail vehicles where the edges of the boarding platform are not protected by screens or guards
- Boarding and alighting areas at sidewalk or street level transit stops for rail vehicles where the side of the boarding and alighting areas facing the rail vehicles is not protected by screens or guards.

STANDARD COLORS



CUSTOM COLORS

Large variety available. Let us know how we can help.





SECTION 32 17 26 - TACTILE WARNING SURFACE DETECTABLE WARNING SURFACE PANELS CAST-IN-PLACE REPLACEABLE

PART 1 - GENERAL

1.1 RELATED DOCUMENTS

- A Drawings and general provisions of Contract, including General and Special Conditions and Division 1 Specifications Section, apply to this Section.

1.2 DESCRIPTION

- A This Section specifies furnishing and installing Cast-In-Place Replaceable Detectable Warning Surface Panels where indicated. Not recommended for asphalt applications.

1.3 SUBMITTALS

- A Product Data: Submit manufacturer's literature describing products, installation procedures, and routine maintenance.
- B Samples for Verification Purposes: Submit two (2) samples minimum 12" x 12" (305 x 305 mm) of the kind proposed for use.
- C Shop drawings are required for products specified showing fabrication details, panel surface profile, fastener locations, plans of panel placement including joints, and material to be used as well as outlining installation materials and procedure.
- D Material Test Reports: Submit complete test reports from qualified accredited independent testing laboratories to qualify that materials proposed for use are in compliance with requirements and meet or exceed the properties indicated on the specifications.
- E Maintenance Instructions: Submit copies of manufacturer's specified installation and maintenance practices for each type of detectable warning surface panel.

1.4 QUALITY ASSURANCE

- A Provide Cast-In-Place Replaceable Detectable Warning Surface Panels and accessories as produced by a single manufacturer with a minimum of three (3) years experience in the manufacturing of tactile walking surface products.
- B Installer's Qualifications: Engage an experienced installer who has successfully completed installations similar in material, design, and extent to that indicated for Project.
- C Cast-In-Place Replaceable Detectable Warning Surface Panels shall be compliant with the following guidelines and requirements (applicability may be dependent on project location):

1. APPLICABLE TO UNITED STATES

- a. American Barriers Act (ABA) Accessibility Standards
- b. ADA Accessibility Guidelines (ADAAG)
- c. Department of Transportation ADA Standards for Transportation Facilities (2006)
- d. Department of Justice ADA Standards (2010)
- e. Public Rights-of-Way Accessibility Guidelines (PROWAG)
- f. California Building Standards Code, Title 24, California Code of Regulations
- g. Texas Accessibility Standards (TAS) 2012
- h. AASHTO M 333 Standard Specification for Detectable Warning Surfaces
- i. International Code Council (ICC) A117.1 Accessible and Usable Buildings and Facilities

2. APPLICABLE TO CANADA

- a. ISO 23599:2012(E): Assistive Products for Blind & Vision Impaired Persons – Tactile Walking Surf. Indicators
- b. CSA B651-18: Accessible Design for the Built Environment Standard – Section 4.3.5
- c. Integrated Accessibility Standards Regulation 191/11 – Sections 80.25 to 80.29
- d. Ontario Building Code 3.8.3.18. Tactile Attention Indicators
- e. National Building Code of Canada: Section 3.3.1.19 Tactile Walking Surface Indicators

D Cast-In-Place Replaceable Detectable Warning Surface Panels shall be manufactured from fiberglass reinforced polymer composite. Panels shall incorporate the following design elements:

- 1. In-line pattern of truncated domes oriented parallel to panel edges
- 2. Dome height of 0.20” (5 mm)
- 3. Dome base diameter of 0.9” (23 mm)
- 4. Dome top diameter of 0.45” (12 mm)
- 5. Dome spacing of 2.35”(60 mm) to 2.40” (61 mm) center to center
- 6. Traction elements on top of domes and in the field between dome bases shall consist of a micro texture of raised points 0.05” high (1.2 mm)

E Cast-In-Place Replaceable Detectable Warning Surface Panels shall meet or exceed the following test criteria using the most current test methods:

Test Method	Test Description	Value
ASTM D 695	Compressive Strength	≥ 28,900 psi (199.2 Mpa)
ASTM D 790	Flexural Strength	≥ 21,000 psi (144.7 Mpa)
ASTM D 638	Tensile Strength	≥ 11,000 psi (75.8 Mpa)
ASTM D 570	Water Absorption	≤ 0.05%
ASTM C 1028	Slip Resistance	≥ 0.80 wet/dry
ASTM E 84	Flame Spread Index	≤ 25
ASTM B 117	Salt Spray	No Effect
ASTM 1308	Chemical Stain	No Effect
ASTM C 501	Abrasion Resistance (lw)	> 500
ASTM G 155	Accelerated Weathering (2000hrs)	ΔE < 5
AASHTO-H20	Load Bearing at 10,410 lbs.	No Effect
ASTM C 1026	Freeze/Thaw/Heat	No Effect
ASTM D 1037	Accelerated Aging	No Effect

1.5 DELIVERY, STORAGE AND HANDLING

- A Cast-In-Place Replaceable Detectable Warning Surface Panels shall be packaged to prevent damage in shipment or handling. Finished surfaces shall be protected by sturdy wrappings and products shall be identified by part number.
- B Cast-In-Place Replaceable Detectable Warning Surface Panels shall be delivered to a location at the building site for storage before installation. Store panels in an area that is within an acceptable temperature range 40°F - 90°F (4°C - 32°C) and maintain the storage facility in a clean, dry condition to prevent contamination or damage to the panels.

1.6 SITE CONDITIONS

- A Environmental Conditions and Protection: Maintain minimum temperature of 40°F (4°C) in spaces to receive Cast-In-Place Replaceable Detectable Warning Surface Panels for at least 24 hours prior to installation, during installation, and for not less than 24 hours after installation.

1.7 WARRANTY

- A Cast-In-Place Replaceable Detectable Warning Surface Panels shall be warranted by the manufacturer in writing for a period of five (5) years from date of final completion. The guarantee includes manufacturing defects, breakage, and deformation.
- B Cast-In-Place Replaceable Detectable Warning Surface Panel installation shall be warranted in writing for two (2) years by the installer. Products must be guaranteed from defective work and loosening of panels.

PART 2 – PRODUCTS

2.1 MANUFACTURERS

- A. **Access Tile** Cast-In-Place Replaceable Detectable Warning Surface Panels as manufactured by **SureWerx**, 325 Corporate Drive, Elgin, Illinois 60123. Phone 844-697-2920, orders.ci.usa@surewerx.com, www.accestile.com/

1. Panel Sizes (nominal):
 - a. 12" x 12" (305 x 305 mm)
 - b. 24" x 24" (610 x 610 mm)
 - c. 24" x 36" (610 x 915 mm)
 - d. 24" x 48" (610 x 1220 mm)
 - e. 24" x 60" (610 x 1524 mm)
 - f. 36" x 48" (915 x 1220 mm)
 - g. 36" x 60" (915 x 1524 mm)
 - h. Radius 24" x 30" (610 x 762 mm) with 15 foot (4.57 m) outer radius
2. Color: Color shall be single, homogeneous color throughout panel and be close approximation of the following AMS-STD-595 color numbers:
 - a. Federal Yellow (YW), Color No. 33538
 - b. Brick Red (RD), Color No. 22144
 - c. Colonial Red (COL) Color No. 20109
 - d. Safety Red (SR) No. 31350

- e. Onyx Black (BK) No. 17038
- f. Dark Gray (G) No. 36118

2.2 MATERIALS

- A. Panel Composition: Cast-In-Place Replaceable Detectable Warning Surface Panels shall be manufactured using an exterior grade homogeneous (uniform color throughout thickness of product) fiberglass reinforced polyester based composite material. Truncated domes must contain fiberglass reinforcement within the truncated dome for superior structural integrity and impact resistance. Use of tactile warning surface products employing colored coatings is expressly prohibited.

PART 3 – EXECUTION

3.1 PREPARATION

- A. During all concrete pouring and panel installation procedures, ensure adequate safety guidelines are in place and that they are in accordance with the applicable industry and government standards.
- B. The physical characteristics of the concrete shall be consistent with the Contract Specifications while maintaining a slump range of 4 - 7 to permit solid placement of the panel.
- C. An overly wet mix will cause the panel to float. Under these conditions, suitable weights such as 2 concrete blocks or sandbags (25 pounds) shall be placed on each panel.
- D. The concrete shall be poured and finished, true and smooth to the required dimensions and slope prior to CIP REP panel placement.

3.2 EQUIPMENT

- A. Contractor shall provide all tools, equipment, and services required for satisfactory installation per manufacturer's instruction as Incidental Work. Equipment which may be required include typical mason's tools, a 4-foot level with electronic slope readout, 25 lb. (11.4 kg) weights, vibrator, rubber mallet with 2" x 4" x 10" (51 mm x 102 mm x 254 mm) wood tamping plate, and a device for cutting the Detectable Warning Surface Panels.

3.3 INSTALLATION

- A. Contractor will not be allowed to install panels until all submittals have been reviewed and approved by the Engineer. Panels shall be installed according to the manufacturer's instructions.
- B. To the maximum extent possible, the panels shall be oriented such that the rows of in-line truncated domes are parallel with the direction of the ramp. When multiple panels regardless of size are used, the truncated domes shall be aligned between the panels and throughout the entire tactile warning surface installation.
- C. In accordance with the Accessibility Guidelines for Pedestrian Facilities in the Public Rights of Way 2011, panels shall be located relative to the curb line as shown within Sections 304 and 305 of the Guidelines.
- D. Panels shall be tamped or vibrated into the fresh concrete to ensure that there are no voids or air pockets, and the field level of the panel is flush to the adjacent concrete surface or as the Drawings indicate to permit proper water drainage and eliminate tripping hazards between adjacent finishes.

- E. Panels shall be cut into size and configuration indicated on the Drawings using a 60-tooth carbide blade on a table saw or equivalent cutting device. Minimize any cantilever effect (to the maximum extent practicable) when cutting between successive embedment ribs as concrete will tend to flow up and over the panels. The top of the body of the panel shall be fully seated and flush with the adjacent concrete substrate. For specific instructions for cutting and setting refer to Detectable Warning Surface manufacturer's written instructions.

3.4 CLEANING, PROTECTING, AND MAINTENANCE

- A. Protect panels against damage during construction period.
- B. Protect panels against damage from rolling loads following installation by covering them with plywood or other protective measures.
- C. Clean panels not more than four days prior to scheduled date for inspection intended to establish date of substantial completion in each area of project. Clean panels by method specified by manufacturer.
- D. Comply with manufacturer's maintenance manual for cleaning and maintaining panel surface and it is recommended to perform annual inspections for safety and panel integrity.

END OF SECTION

1'X1'

REPLACEABLE CAST IN PLACE
2.35" DOME SPACING

www.AccessTile.com 888-679-4022

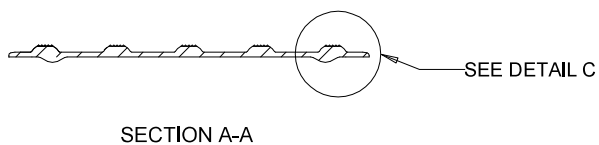
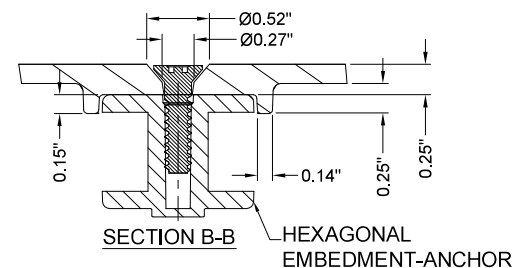
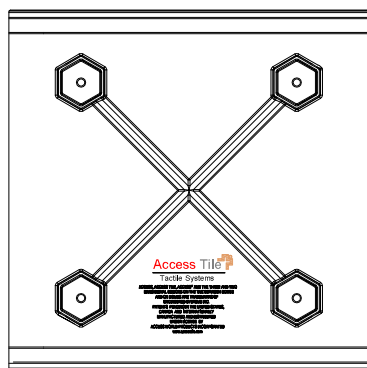
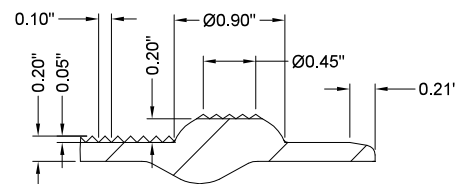
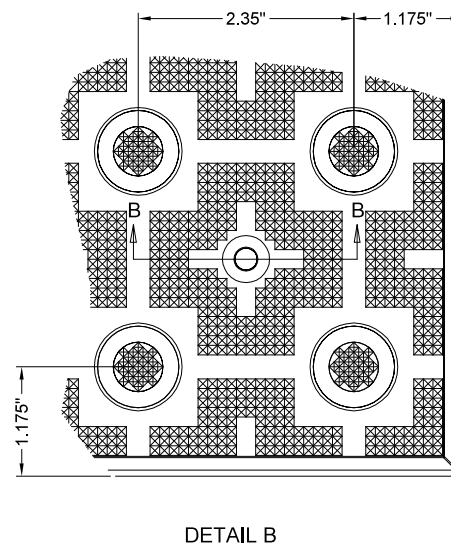
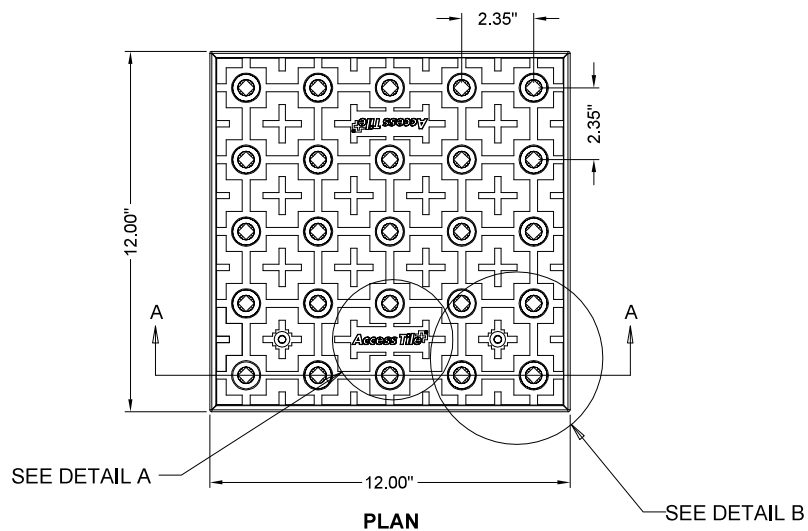

www.AccessTile.com
Access Products Inc

© Access Products Inc.
ACCESS, ACCESS TILE, ACCESS + AND THE
TWO AND THREE DIMENSIONAL DESIGNS
ON THE DOMES ARE TRADEMARKS OF
ENGINEERED SYSTEMS INC.
PATENTS PENDING IN THE USA, CANADA
AND INTERNATIONALLY. MANUFACTURED
AND DISTRIBUTED BY
ACCESS WORLD PRODUCTS INC.
www.accesstile.com
© KENNETH E. SZEKELY

MATERIAL LIST

ITEM	DESCRIPTION	PART NO.	QTY
1	ACCESS TILE	ACC-R-1X1	1
2	ANCHOR ASSEMBLY	ACC-R-ANCH	4

NOTE: ANCHOR ARE INCLUDED AND ASSEMBLED ON TILE.

REFERENCE DRAWINGS

DWG. NO.	DESCRIPTION

No.	DATE	REVISION	APPR.

SCALE
1"=1'-0" U.S.O.
FULL SIZE ONLY

DESIGNED	KES	DATE	10/09/2008
DRAWN	RWO	DATE	10/15/2008
DRAWN	KES		

PROJECT MANAGER

TRADE	DETECTABLE WARNING SURFACE	PART NO.	ACC-R-1X1
-------	----------------------------	----------	-----------

MATERIAL POLYMER COMPOSITE

SUBJECT **ACCESS TILE®**
TRUNCATED DOME, DETECTABLE
WARNING TACTILE SURFACE

PROJECT **ACCESS TILE®**
TRUNCATED DOME, DETECTABLE
WARNING TACTILE SURFACE
1X1 REPLACEABLE CAST IN PLACE
INLINE DOME TILE DRAWING.

DRAWING NO.	ACC-R-1X1	REV. NO.	0
-------------	-----------	----------	---

2'X5'

**REPLACEABLE CAST IN PLACE
2.35" DOME SPACING**

www.AccessTile.com 888-679-4022

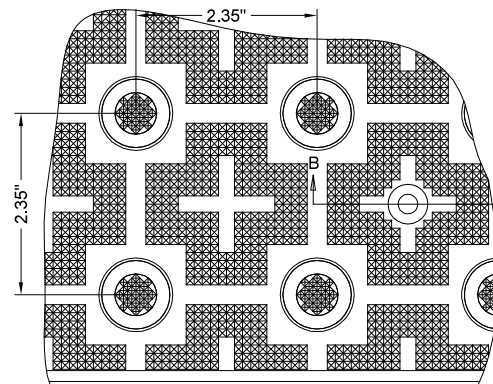
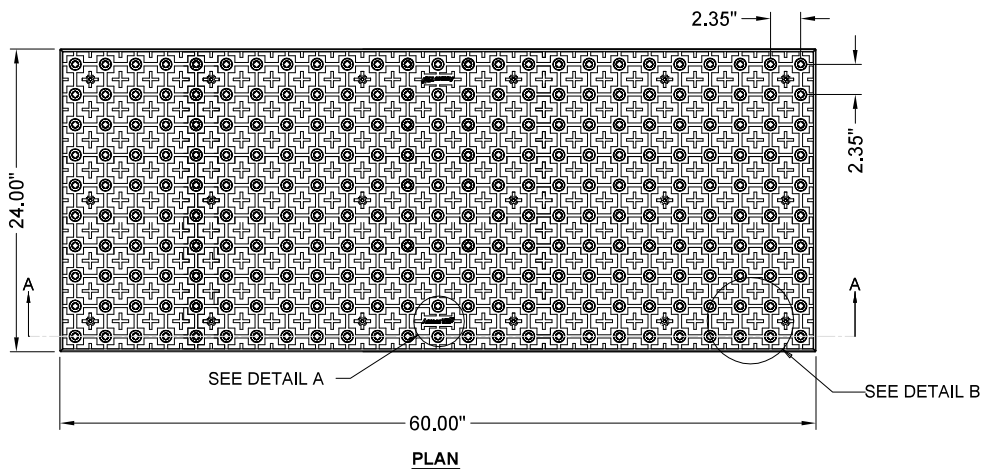

DETAIL B

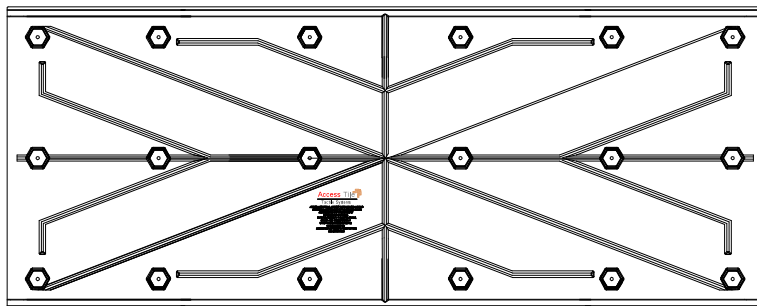

UNDERSIDE VIEW

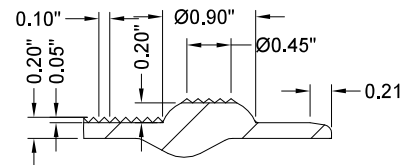

DETAIL C

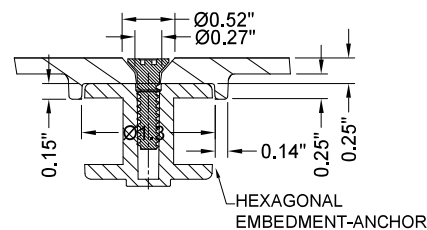

SECTION B-B

HEXAGONAL
EMBEDMENT-ANCHOR

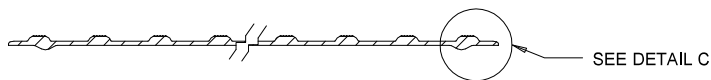

SECTION A-A

SEE DETAIL C



DETAIL A

www.AccessTile.com
Access Products Inc

© Access Products Inc.
ACCESS, ACCESS TILE, ACCESS + AND THE
TWO AND THREE DIMENSIONAL DESIGNS
ON THE DOMES ARE TRADEMARKS OF
ENGINEERED SYSTEMS INC.
PATENTS PENDING IN THE USA, CANADA
AND INTERNATIONALLY. MANUFACTURED
AND DISTRIBUTED BY
ACCESS WORLD PRODUCTS INC.
www.accesstile.com
© KENNETH E. SZEKELY

MATERIAL LIST

ITEM	DESCRIPTION	PART NO.	QTY
1	ACCESS TILE	ACC-R-2X5	1
2	ANCHOR ASSEMBLY	ACC-R-ANCH	15

NOTE: ANCHOR ARE INCLUDED AND ASSEMBLED ON TILE.

REFERENCE DRAWINGS

DWG. NO.	DESCRIPTION

No.	DATE	REVISION	APPR.

SCALE
1"=1'-0" U.S. & C. FULL SIZE ONLY

DESIGNED	KES	DATE	10/09/2008
DRAWN	RWO	DATE	10/15/2008
DRAWN	KES		

PROJECT MANAGER

TRADE
DETECTABLE WARNING SURFACE

MATERIAL
POLYMER COMPOSITE

SUBJECT
ACCESS TILE®
TRUNCATED DOME, DETECTABLE
WARNING TACTILE SURFACE

PROJECT
ACCESS TILE®
TRUNCATED DOME, DETECTABLE
WARNING TACTILE SURFACE
2X5 REPLACEABLE CAST IN PLACE
INLINE DOME TILE DRAWING.

DRAWING NO.	ACC-R-2X5	REV. NO.	0
-------------	-----------	----------	---

3'X5'

**REPLACEABLE CAST IN PLACE
2.35" DOME SPACING**

www.AccessTile.com 888-679-4022

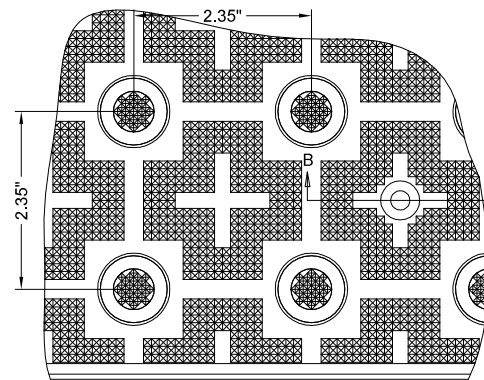
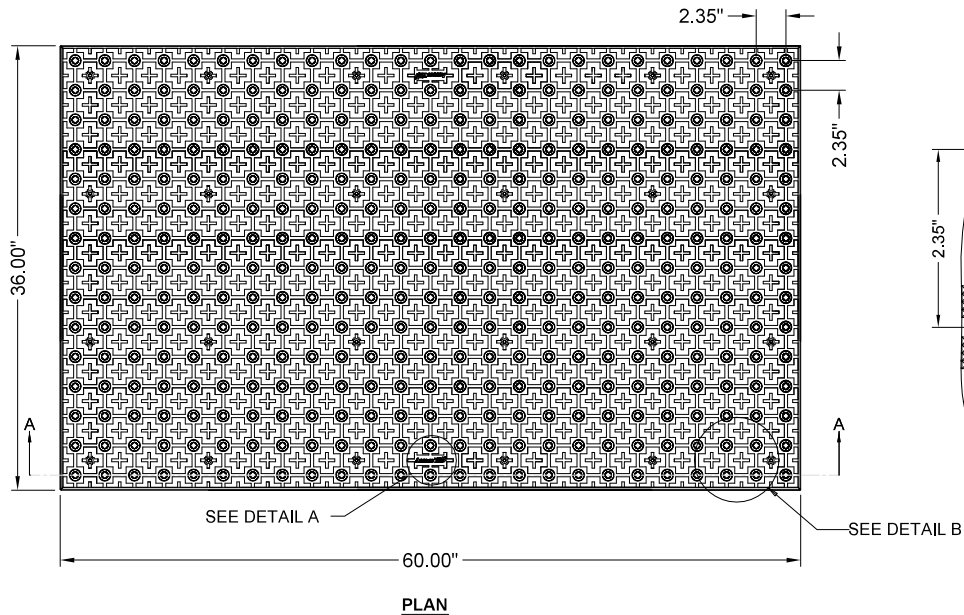

DETAIL B

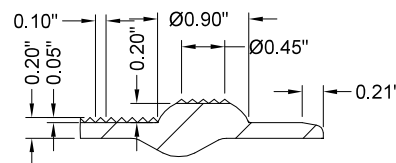

DETAIL C

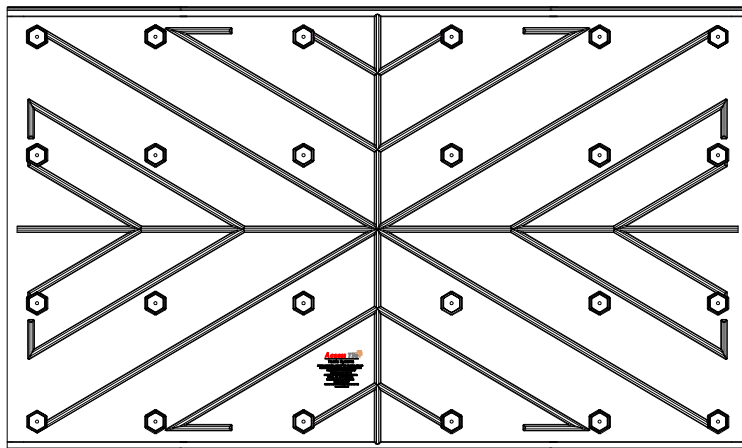

UNDERSIDE VIEW

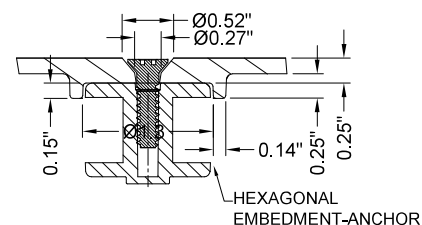

SECTION B-B

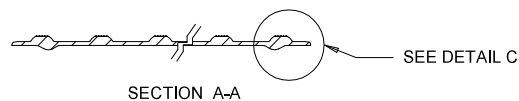

DETAIL A

www.AccessTile.com
Access Products Inc

© Access Products Inc.
ACCESS, ACCESS TILE, ACCESS + AND THE
TWO AND THREE DIMENSIONAL DESIGNS
ON THE DOMES ARE TRADEMARKS OF
ENGINEERED SYSTEMS INC.
PATENTS PENDING IN THE USA, CANADA
AND INTERNATIONALLY. MANUFACTURED
AND DISTRIBUTED BY
ACCESS WORLD PRODUCTS INC.
www.accessTile.com
© KENNETH E. SZEKELY

MATERIAL LIST

ITEM	DESCRIPTION	PART NO.	QTY
1	ACCESS TILE	ACC-R-3X5	1
2	ANCHOR ASSEMBLY	ACC-R-ANCH	24

NOTE: ANCHOR ARE INCLUDED AND ASSEMBLED ON TILE.

REFERENCE DRAWINGS

DWG. NO.	DESCRIPTION

No.	DATE	REVISION	APPR.

SCALE
1"=1'-0" U.S. & C. FULL SIZE ONLY

DESIGNED	KES	DATE	10/09/2008
DRAWN	RWO	DATE	10/15/2008
DRAWN	KES		

PROJECT MANAGER

TRADE: DETECTABLE WARNING SURFACE PART NO. ACC-R-3X5

MATERIAL: POLYMER COMPOSITE

SUBJECT: **ACCESS TILE®**
TRUNCATED DOME, DETECTABLE
WARNING TACTILE SURFACE

PROJECT: **ACCESS TILE®**
TRUNCATED DOME, DETECTABLE
WARNING TACTILE SURFACE
3X5 REPLACEABLE CAST IN PLACE
INLINE DOME TILE DRAWING.

DRAWING NO.	ACC-R-3X5	REV. NO.	0
-------------	-----------	----------	---

CURVE

REPLACEABLE CAST IN PLACE 2.35" DOME SPACING

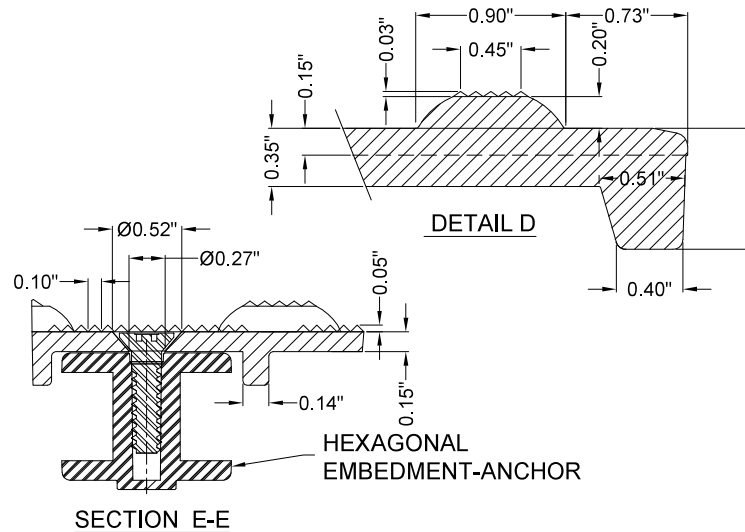
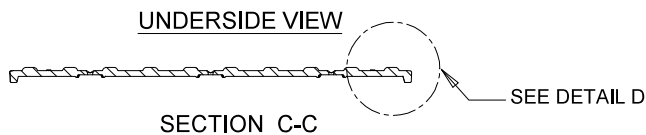
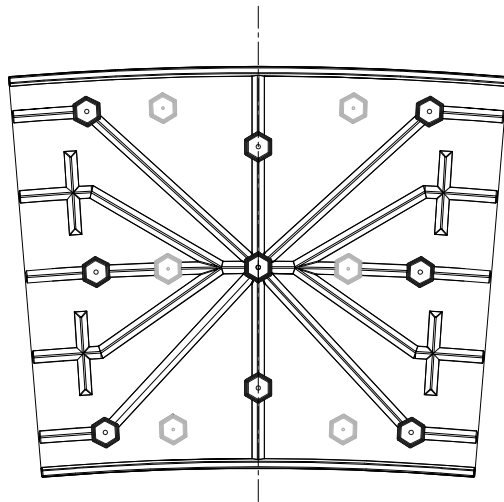
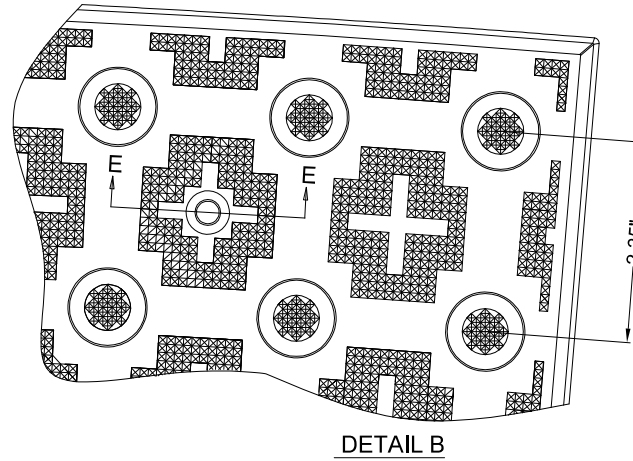
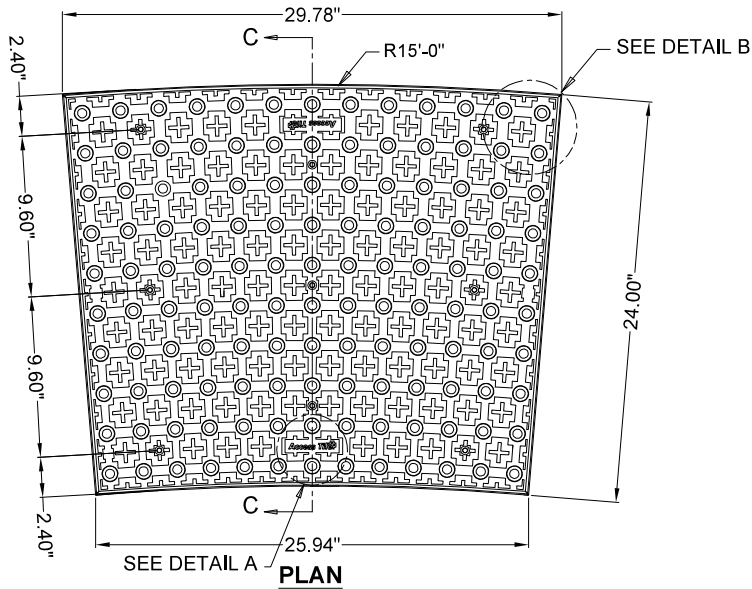

NOTE: ALL CUT LINE RADII REFERENCE LARGER TILE RADIUS

AccessTile.com

Access Products Inc.

ACCESS, ACCESS TILE, ACCESS AND THE THREE AND TWO DIMENSIONAL DESIGNS ON THE TILE BETWEEN DOMES AND ON DOMES ARE TRADEMARKS OF ENGINEERED SYSTEMS INC.

PATENTS PENDING IN THE UNITED STATES, CANADA AND INTERNATIONALLY.

MANUFACTURED AND DISTRIBUTED UNDER LICENSE BY ACCESS WORLD PRODUCTS INCORPORATED.

MATERIAL LIST

ITEM	DESCRIPTION	PART NO.	QTY
1	ACCESS TILE	ACC-R-2X2CRV	1
2	ANCHOR ASSEMBLY	ACC-R-ANCH	9

NOTE: ANCHORS ARE INCLUDED AND ASSEMBLED ON TILE

REFERENCE DRAWINGS

DWG. NO.	DESCRIPTION

No.	DATE	REVISION	APPR.

SCALE: 1"=1'-0" U.N.O. FULL SIZE ONLY

DESIGNED	KES	DATE	12/20/2013
DRAWN	VS		06/26/2014
CHECKED	DD		

PROJECT MANAGER	
-----------------	--

TRADE	DETECTABLE WARNING SURFACE	PART NO.	ACC-R-2X2CRV
-------	----------------------------	----------	--------------

MATERIAL: POLYMER COMPOSITE

SUBJECT: **ACCESS TILE®**
TRUNCATED DOME, DETECTABLE WARNING TACTILE SURFACE

PROJECT: **ACCESS TILE®**
TRUNCATED DOME, DETECTABLE WARNING TACTILE SURFACE
2X2 CURVED REPLACEABLE CAST IN PLACE INLINE DOME TILE DRAWING.

DRAWING NO.	ACC-R-2X2CRV	REV. NO.	Ø
-------------	--------------	----------	---

REPLACEABLE CAST IN PLACE *Installation Instructions*

The following instructions apply to Access® Tile's Replaceable Cast in Place tiles as well as the Radius Curve and Wayfinding version of these tiles.

1. Maintaining a 4 - 7 slump range, pour and float the concrete.
2. Without removing any concrete, place the tile 6" - 8" from the curb line (face of curb).
3. Tamp the tile in grid pattern across the top face, embedding the tile into the concrete using a non-marring rubber mallet.
4. Place sandbags or 25 lb. weights on the tile to prevent floating and create an edge around the perimeter of the tile using a 3/8" radius edging tool then float the concrete around the tile's perimeter using a steel trowel.
5. Apply a broom-finish to the surrounding concrete.
6. After the concrete has substantially cured, remove the protective plastic wrap by cutting the plastic with a sharp knife tight to the concrete / tile interface.

NOTE: If concrete bled under the plastic, a soft wire brush will residue without damaging the tile.



01



02



03



04



05



06

Replacement Instructions

- A. Unscrew T27 tamper-proof fasteners.
- B. Tap the perimeter of the tile with a rubber mallet to remove the bond of the tile to the concrete.
- C. Use a pry bar to pry up an edge. Remove all debris from the vacant cavity mold. Vacuum / sweep all crevices.
- D. Insert replacement tile, gently apply pressure to seat tile in recess. Reinsert tamper-proof fasteners in hex-shaped concrete anchors.

Tiles can be cut to custom sizes, or to make a radius, using a continuous rim diamond blade in a circular saw or mini-grinder. Use of a straightedge to guide the cut is advisable where appropriate.

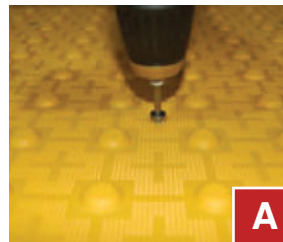

A



B



C

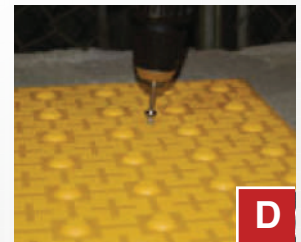

D



A SureWerx Brand

Certificate of Compliance

Issued Date: **08/01/2024**

Issued To: **Company**

Project: **Project/Project Reference**

Manufacturer: **SureWerx (Access Tile, a SureWerx Brand)**

Product: **Cast In Place Replaceable Detectable Warning Panels, Federal Yellow**

Description: Fiberglass reinforced polymer composite material

SureWerx certifies that the above identified product is compliant with the following standards and guidelines:

- Architectural Barriers Act (ABA 2015), Chapter 705 Detectable Warnings
- Department of Justice ADA Standards (2010), Chapter 705 Detectable Warnings
- Department of Transportation ADA Standards for Transportation Facilities (2006), Chapter 705 Detectable Warnings
- Pedestrian Right-Of-Way Accessibility Guidelines (PROWAG), Chapter R305 Detectable Warning Surfaces
- California Building Standards Code, Title 24 of the California Code of Regulations (Title 24) Chap 11B-705.1 Detect. Warnings
- International Code Council, 2017 ICC A117.1 Accessible and Usable Bldgs. and Facilities, Sect. 705 Detect. Warning Surfaces

SureWerx certifies that the above identified product meets all the applicable specification requirements for Detectable Warning Surface for [State] Department of Transportation.

The identified product has been tested in accordance with the following test methods (Individual test results are available upon request. Contact SureWerx for additional information):

- | | |
|---|---------------------------------------|
| • ASTM D695 Compressive Strength | • ASTM D 638 Tensile Strength |
| • ASTM C 1028 Standard Test Method for Determining the Static Coefficient of Friction (Slip Resistance) | • ASTM D1037 Freeze/Thaw |
| • ASTM D570 Water Absorption | • ASTM E84 Flame Spread Index |
| • ASTM D790 Flexural Strength | • ASTM C501 Abrasion Resistance |
| • ASTM C1026 Freeze/Thaw/Heat | • ASTM G155 Accelerated Weathering |
| • ASTM-B117 Salt and Spray | • ASTM D543 Chemical Stain Resistance |
| | • AASHTO H20 Load Bearing Test |

Issued by:

John Stieby

Name

Director of End User Sales

Title

00/00/2024

Date



A SureWerx Brand

5 YEAR PRODUCT WARRANTY Fiberglass Reinforced Polymer Composite Products

SureWerx warrants to the Project Owner that the AccessTile Tactile Walking Surface Indicator products supplied by SureWerx are free from defects in material including deformation, breakage, and delamination for a period of Five (05) years from the date of substantial completion of the project.

EXCLUSIVE REMEDIES: SureWerx, at its cost, will repair or replace defective material promptly reported to SureWerx during the warranty period. This warranty includes labor costs and cost of removal of the product. Repair or replacement will be done on site.

WARRANTY LIMITATIONS: The warranty of AccessTile products does not apply to conditions resulting from improper installation, improper use, external causes, intentional misuse, or abuse, neglected or improper annual maintenance, vandalism, modifications to the AccessTile products or installation procedures with the exception of the Owner's right to immediately eliminate an unsafe condition.

DISCLAIMER OF WARRANTY: The above warranties are the Owner's exclusive warranties. No other warranty, express or implied, shall apply. SureWerx specifically makes no warranty of merchantability and/or fitness for a particular purpose. In no event shall SureWerx be liable for any damages, lost profits, direct, consequential, or economic damages.

Issued Date: 00/00/2024
Effective Date: 00/00/2024

Project: Name/Identifier

Issued to: Contractor Name
Address
City, ST 00000

Owner: Owner Name
Address
City, ST 00000

Manufacturer: **SureWerx (AccessTile, a SureWerx Brand)**
Product: Detectable Warning Panels, Brick Red Fiberglass
Description: reinforced polymer composite material

Issued by:

John Stieby
Name

Director of End User Sales
Title

00/00/2024
Date



325 Corporate Drive
Elgin, IL 60123
USA

US Customer Service
Tel: 1-844-697-2920 | Fax: 1-833-652-1547
Email: orders.ci.usa@surewerx.com

www.surewerx.com