



ACO StormBrixx®

Geocellular Stormwater Storage Products for  
Detention, Retention, Reuse, & Infiltration Systems

StormBrixx SD  
StormBrixx HD  
Flow Control



ACO. creating

the future of drainage

## The ACO Group

Founded in 1946, the ACO Group is a world leader in drainage technology. Climate change sets us a challenge to react effectively with innovative solutions to new environmental conditions. With its integrated approach, ACO provides systems for professional surface water drainage, efficient cleaning, and the controlled discharge or reuse of water.

Products include:

- surface water drainage
- oil, sediment, heavy metal and grease separators
- detention, retention and infiltration systems
- flow control release products

Major innovative strengths of the ACO Group are its continuous research & development and technical expertise in the processing of polymer concrete, plastics, cast iron, stainless steel and cement concretes.

## ACO in the USA

ACO, Inc. was founded in Ohio, 1978. Since then, continuous growth in the USA has seen the company expand and build manufacturing facilities in Mentor, OH, and Casa Grande, AZ. The company has further locations in Phoenix, AZ, and Fort Mill, SC. Today, ACO USA has sales personnel across the country and an extensive distribution network through all states, the Caribbean and Central America.

## ACO StormBrixx

Developed after three years of meticulous research and development, the ACO StormBrixx product range is an innovative product line which is the strongest and most easily installed injection molded, geocellular product on the global market. StormBrixx SD is manufactured in the USA.

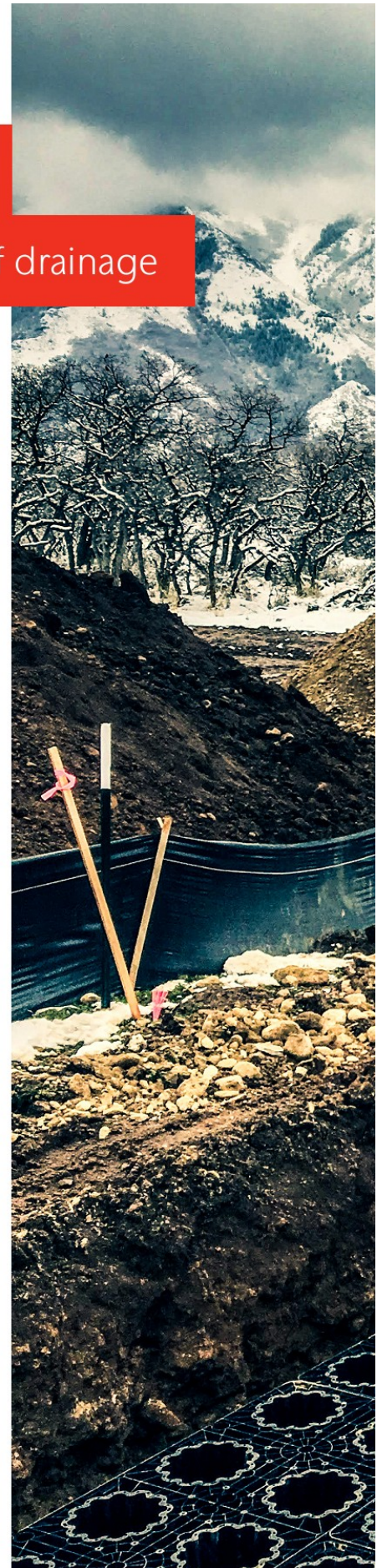





## Contents

<b>1</b>	<b>ACO StormBrixx</b>	
	Features & Benefits	05
<b>2</b>	<b>ACO StormBrixx SD</b>	
	Features & Benefits	25
	Accessories	29
	Parts Listing	35
<b>3</b>	<b>ACO StormBrixx HD</b>	
	Features & Benefits	43
	Accessories	45
	Parts Listing	49
<b>4</b>	<b>ACO Flow Control</b>	
	Features & Benefits	57
	Q-Brake Vortex	59
	Q-Plate	63
<b>5</b>	<b>Technical Services &amp; Product Support</b>	
	Technical Support	67
	Installation	71
	Inspection & Maintenance	85
	Flow Control Op & Maintenance	87
	askACO	89





The Hydrological Cycle is the natural cycle of water from rainfall to evaporation. The ACO System Chain provides products that collect water from impervious surfaces, which is transmitted to products which help clean solids and liquids from this collected surface water. "Hold" and "Release" require systems that can hold and return this water back to nature in a controlled manner, which can be used in conjunction with water reuse programs.





### Detention System

Detention is the process of spreading the peak flow of a storm event over a long period of time, releasing the water slowly, and mitigating the surge effect downstream where the stormwater returns to the natural water course.

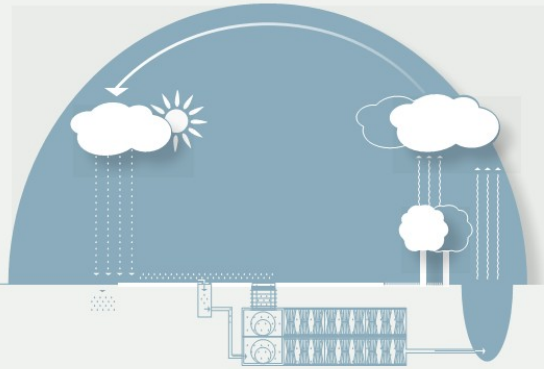

### Retention/Reuse System

Retention is the subsequent process of storing the stormwater for further use.

Sediment can be removed before water enters the retention system by pretreatment or sediment forebays/isolation within the systems.

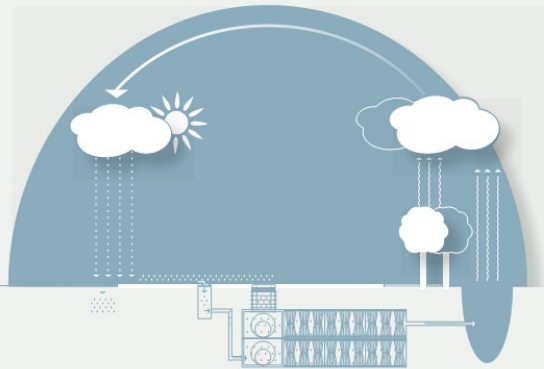

### Infiltration System

Infiltration is the process by which the collected stormwater enters subsurface soil and rock. An infiltration tank stores water, which is gradually released through a geotextile fabric into the surrounding soil.

Sediment should be removed before water enters the infiltration system by pretreatment or sediment forebays/isolation within the systems.

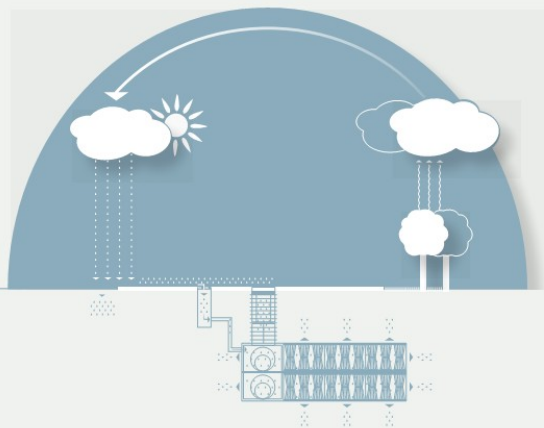

1

# ACO StormBrixx

## Features & Benefits

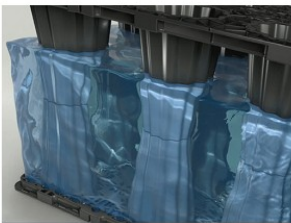

**Maximum Storage** pg. 08

- 95%–97% void ratio
- Minimal excavation required
- Less backfilling aggregate needed
- Improves flow of runoff



**Ease of Installation** pg. 12

- Lightweight material
- Stackable modules which snap together
- High stability during installation
- Customizable configurations

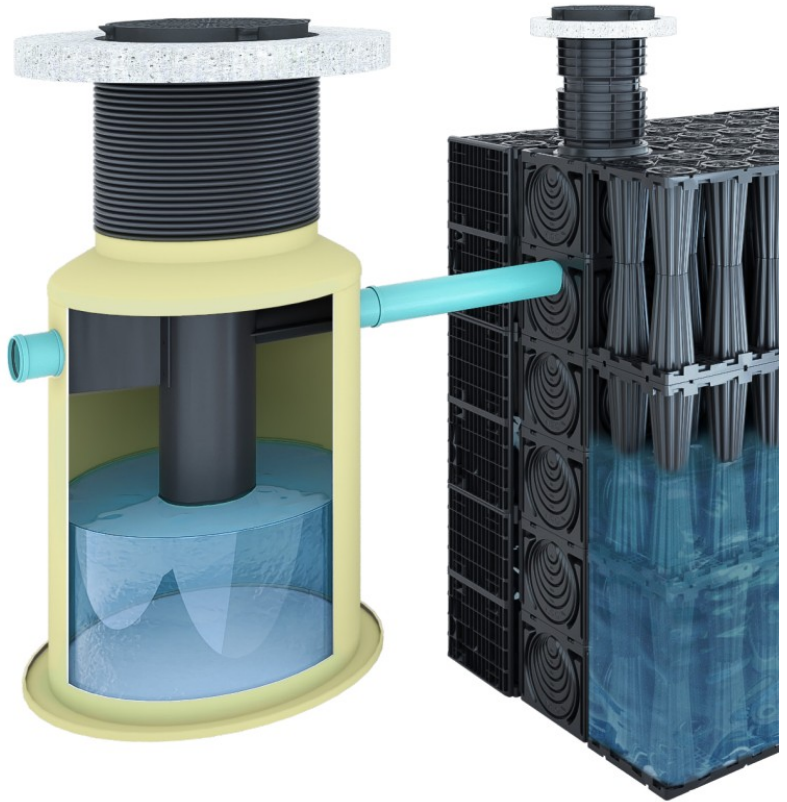

### Pretreatment



ACO Environment  
ACO StormBrixx  
ACO Environment  
ACO

- Needed to remove the following:
  - Sediment
  - Heavy metals
  - Hydrocarbons
- See ACO Environment literature and [www.acoenvironment.us](http://www.acoenvironment.us)





**Flow Control System** pg. 57

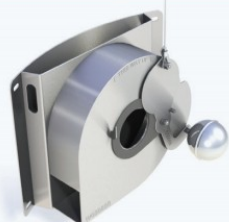

- Release water at a controlled rate
- Reduces upstream attenuation
- Less prone to blockage than orifice plates
- Custom built to suit the chamber

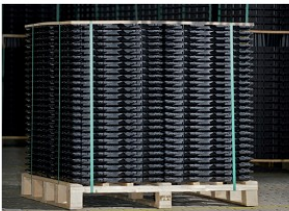

**Logistical Efficiency** pg. 16

- Lightweight material
- Half-modules stack into each other
- More product load per truck
- Lower CO<sup>2</sup> emissions



**Strength & Stability** pg. 18

- Brick-bonding method
- Pillars aligned for even distribution
- CIRIA C680 performance tested
- Satisfies H-20 up to HS-25 loading conditions



**Access & Inspection** pg. 22

- Access shaft for equipment
- Minimal access points required
- Configurable for minimal silt accumulation
- Up to 50–60 year lifespan

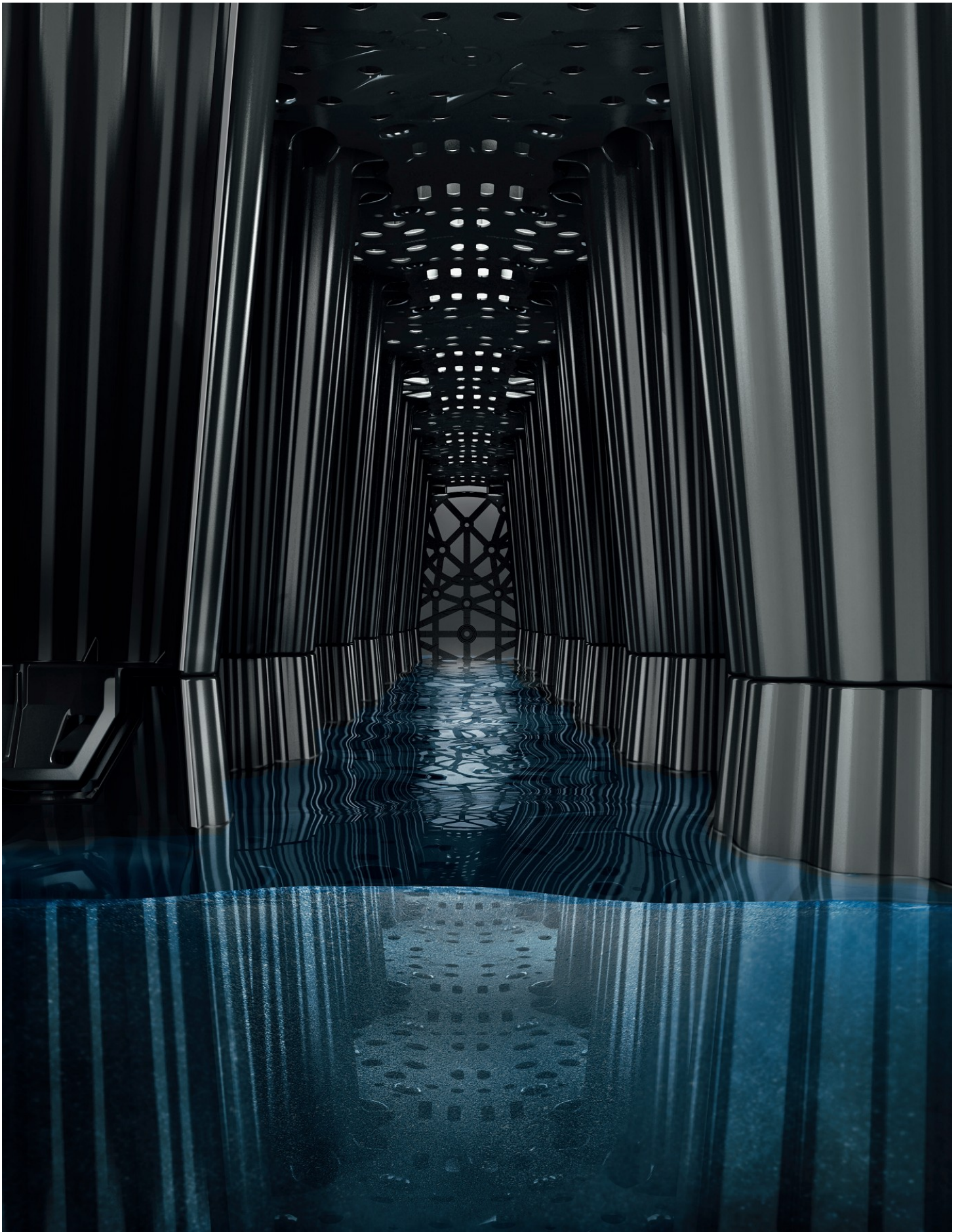



# Maximum Storage

## Geocellular Build Benefits

A unique pillar configuration gives high void ratios of 95% for ACO StormBrixx HD and 97% for ACO StormBrixx SD. Along with maximized storage, this provides the following benefits:

- Minimizes excavation required to achieve specified storage capacity
- Reduces aggregate needed for backfilling
- Improves flow characteristics of runoff through installed system



StormBrixx pillars are hollow, allowing them to fill up with water while maintaining the high structural integrity of a geocellular system.

### COMPARISON OF CROSS-SECTION REQUIRED FOR SAME AMOUNT OF WATER STORAGE

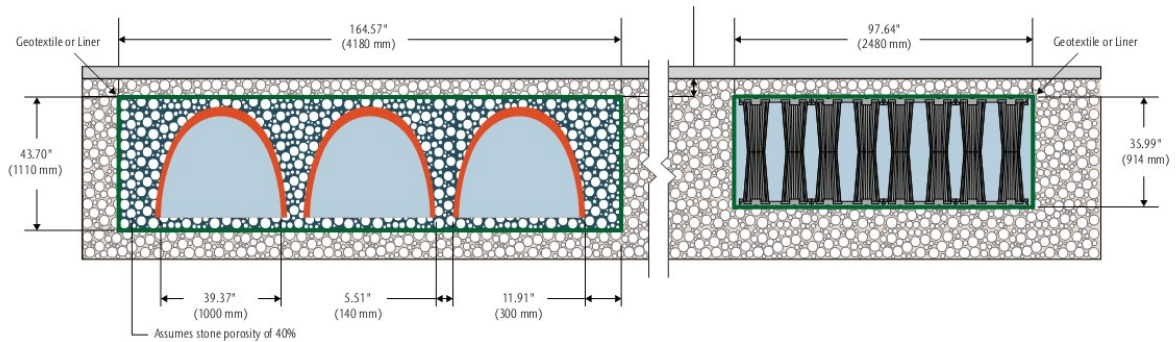

**arch system: 50% void**

**geocellular system: 95% void**

Although concrete and metal tanks provide 100% water storage, they are expensive to build and install. In comparison, geocellular tanks are more economical while providing a high amount of storage (95%–97%). Geocellular tanks also require less excavation and stone than arch systems.

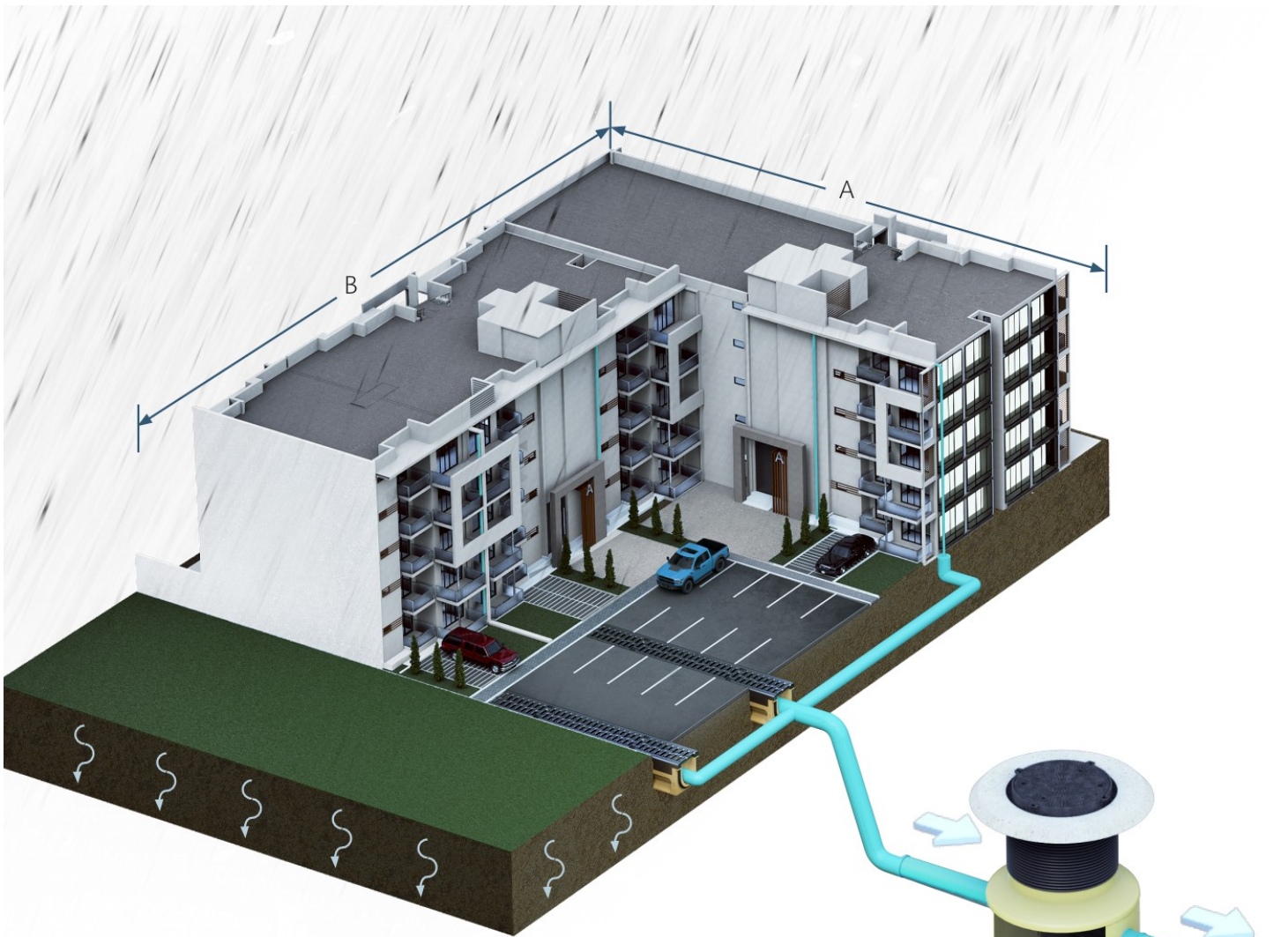

### Catchment Area

When precipitation occurs, water falls onto both softscape (permeable ground) and hardstand (impermeable pavement). In softscape, most water will infiltrate back into the aquifer, returning to the natural water cycle. Precipitation falling on hardstand is collected by surface and roof drains and fed to swales or underground water sewer systems. When underground detention/infiltration tanks are used, this collected water must be calculated to design the correct tank size. Rainfall intensity and square footage ('A' x 'B' in diagram above) of hardstand is required to calculate the volume of the collected water.



### Pretreatment

Water quality is a crucial part of managing stormwater. Contaminants may include silt, suspended hydrocarbons, heavy metals, tire wear, brake dust, soot, sediments and deicing products used during winter. To remove contaminants, a variety of pretreatment units are available. The most common being total suspended-solid separators (TSS), which remove silt and solids prior to infiltration/detention tanks. An evaluation of the site should be carried out to determine types of cleaning separators required.

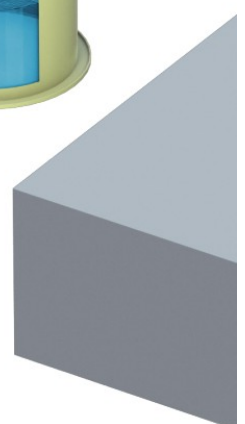



## Hydraulic Performance

Geocellular storage tanks can be an essential part of the stormwater cycle. They are BMP (best management practice) compliant and MS4 program allowable. Low Impact Development (LID) and Sustainable Drainage systems require collected water to be stored and available for either reuse, infiltration back into the ground, or to be stored and released at an acceptable rate back into the watercourse. Release rates back into the watercourse are set by federal, state, and city regulations to avoid flooding.



### Geocellular Storage System

Underground detention/infiltration tanks should be sized according to the water containment required. In some instances—mainly infiltration tanks—a sediment forebay can be built into the tank to collect silt. Geotextiles and liners are applied to wrap tanks used for infiltration (permeable geotextile) or detention (impermeable liners).



### Flow Control

Flow control is required to restrict discharge or regulate it back into the watercourse. Flow controls come in a variety of formats:

- Smaller, restricting pipes
- Gate valves
- Weirs
- Restricting plate valves commonly placed on access shaft inlets or outlets (ACO Q-Plate; see page 63)
- Horizontal vortex flow controls placed on the outlet pipe from the access shaft (ACO Q-Brake Vortex; see page 59)

Vortex flow controls have the advantage of allowing flow regulation and the ability to quickly evacuate water using upstream heads.

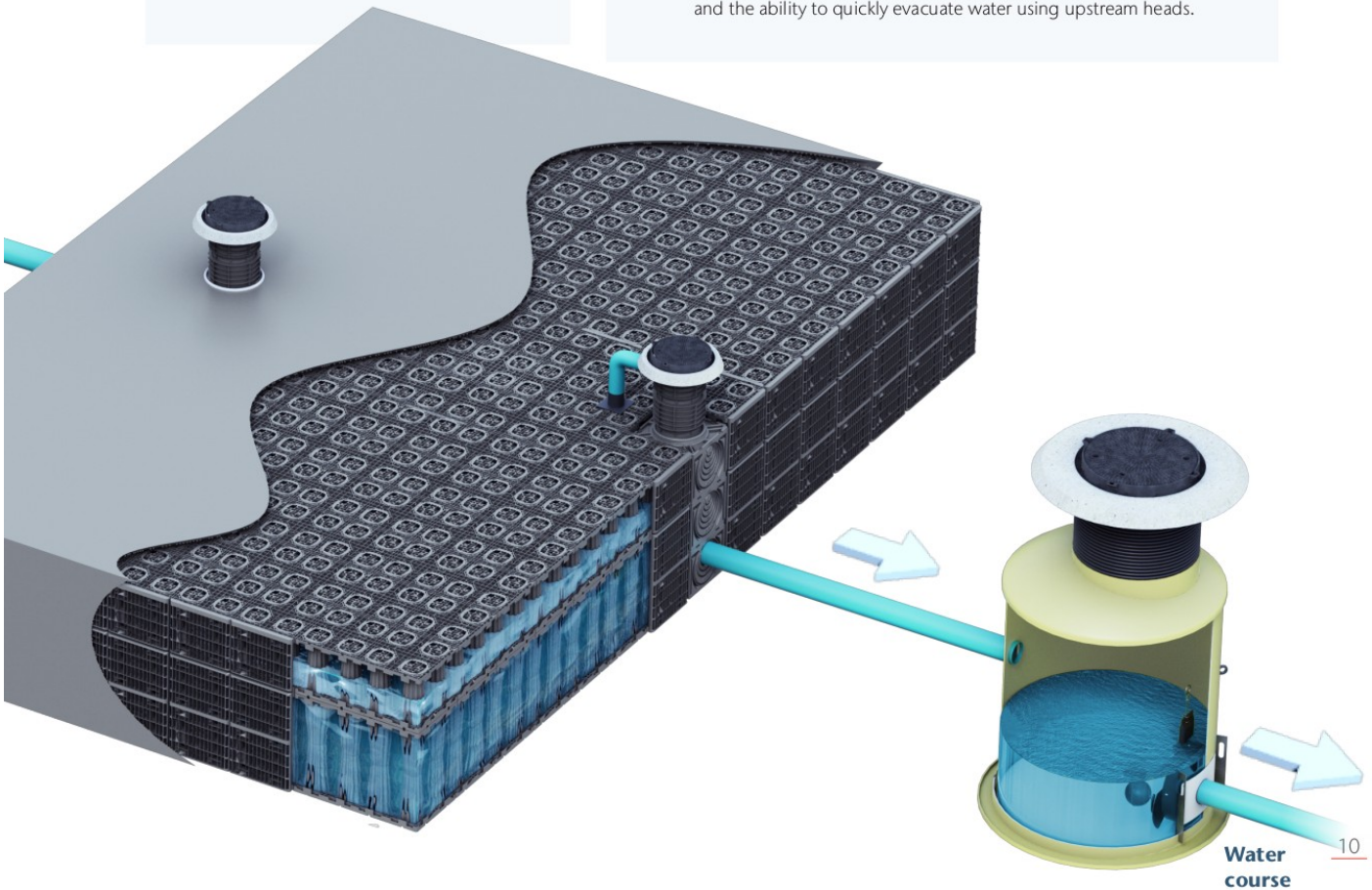

Water course 10





## Ease of Installation

### Clean & Efficient Assembly

ACO StormBrixx half-modules snap and lock into one another vertically by simply placing one atop the other. Layers and adjacent modules are attached using a basic snap-lock system consisting of male and female connectors that audibly lock into place during assembly. This provides an exceptional level of structural support throughout the system.

The StormBrixx system is easily configured to site-specific requirements. Irregular shapes can also be achieved, so the system can be constructed to avoid tree pits, buildings and other ground constraints.



Functional design combined with an intelligent snap-lock system make for easy handling and rapid installation. Small openings at the base of the pillars allow water to fill and drain. This allows the pillars to form part of the high void ratio.





## Brick-bonding

Brick-bonding is a technique to interlock the modules together in an overlapping manner. This method can be performed in both horizontal directions, ensuring that tanks of any size can be assembled and fully interlocked.

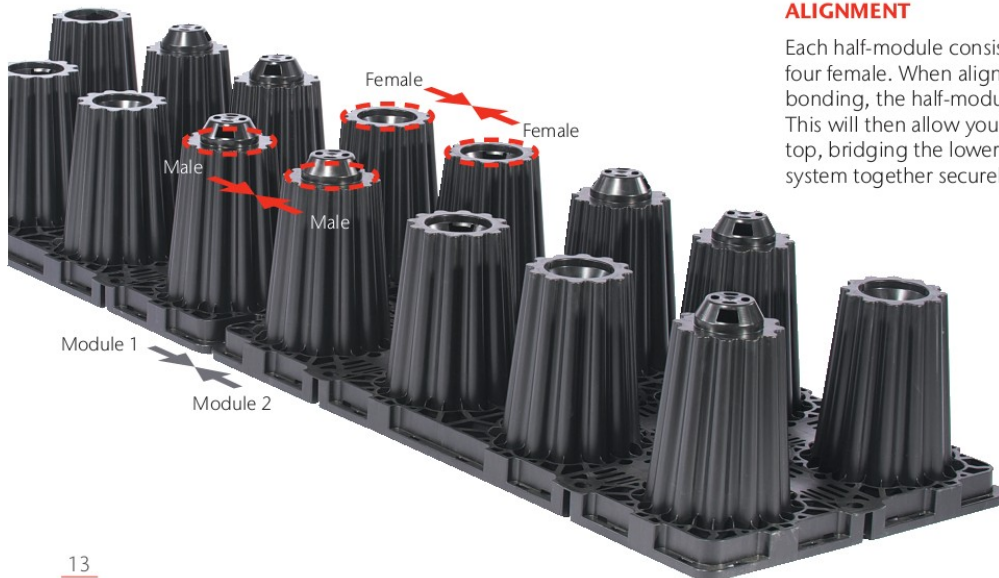

### ALIGNMENT

Each half-module consists of eight pillars: four male and four female. When aligning the half-modules for brick-bonding, the half-modules need to mirror one another. This will then allow you to place another half-module on top, bridging the lower two half-modules and locking the system together securely.



### Brick-bonding structures

#### Triple module unit



#### Quadruple module unit



NOTE: Red coloring is for illustration purposes only. All units are black.

### Completing a brick-bonded structure

To finish the brick-bonded tank, one module will need to be cut in half in certain layouts. The images below detail and display the ease of creating the final piece.

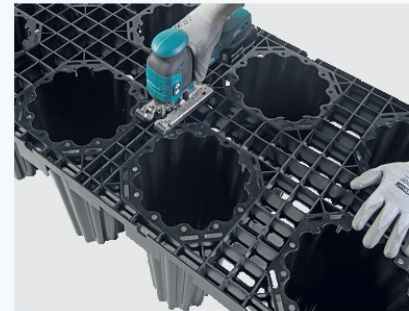







## Logistical Efficiency

### Convenient Loading

ACO StormBrixx SD and HD half-modules are designed to stack inside one another. Compared to other stormwater system manufacturers, less vehicles are needed for transportation to site.

For each delivery of StormBrixx, up to 4 loads of competitor product may be required. This makes StormBrixx approximately 75% more efficient in delivery.

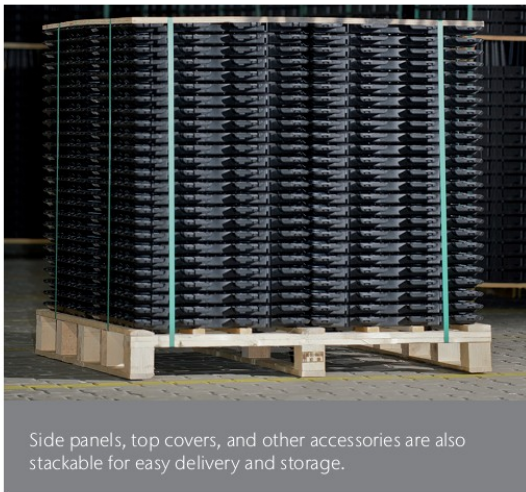

Side panels, top covers, and other accessories are also stackable for easy delivery and storage.



ACO StormBrixx can be easily offloaded from a vehicle and stored in the same stackable layout on-site. Due to the compact arrangement of our product compared to other geocellular units, they can be stored efficiently and discreetly.

### Shipment Quantities

- StormBrixx SD: 15825 ft<sup>3</sup>/truck (448 m<sup>3</sup>/truck)
- StormBrixx HD: 14557 ft<sup>3</sup>/truck (412 m<sup>3</sup>/truck)

Quantities assume the use of a standard 53' box truck.  
Half-modules only. Accessories will reduce cubic volume per truck.

With the quantity of trucks necessary to transport StormBrixx greatly reduced, the savings in both time and money are considerable.

### Environmental Savings



Fewer trucks transporting ACO StormBrixx reduces CO<sup>2</sup> emissions. Fewer deliveries also yield additional savings by avoiding charges (tolls, etc.) commonly found in cities, which particularly affect heavy-duty trucks.



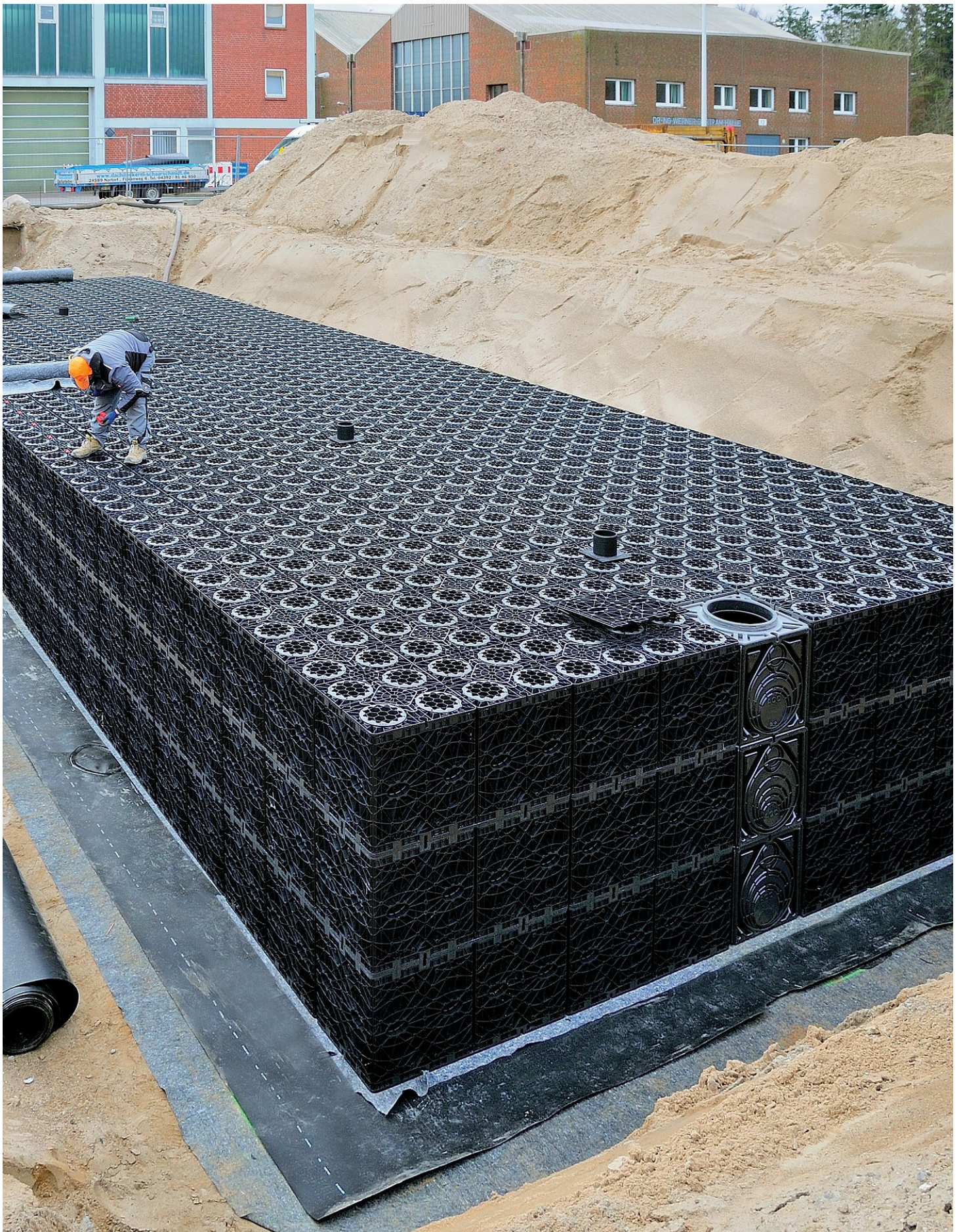



## Strength & Stability

### Stability Through Intelligent Design

Brick-bonding can be applied to ACO StormBrixx SD and HD to provide an immense amount of structural strength. When constructed, the load-bearing pillars of the system precisely align above one another, so that loads are evenly distributed downward.

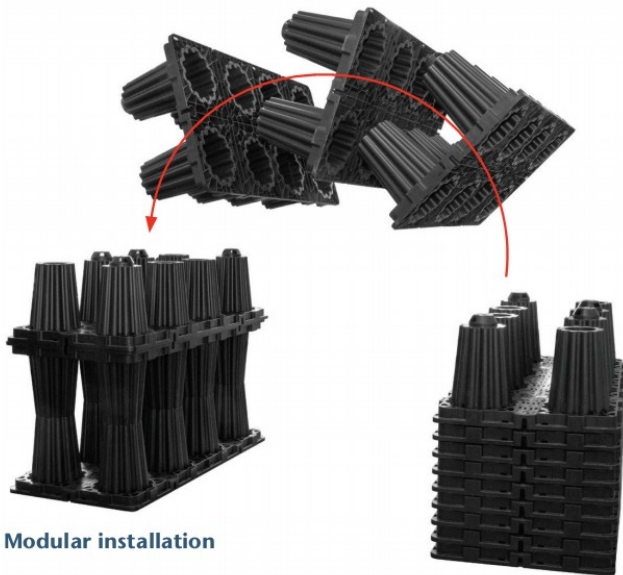
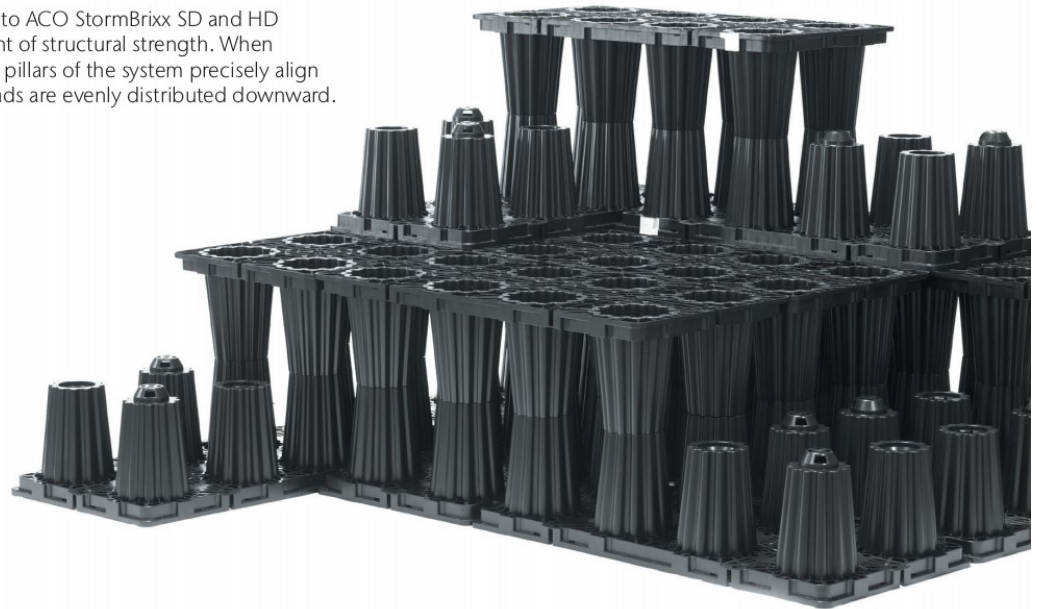

**Modular installation**

#### THE MODULAR SYSTEM

ACO StormBrixx is a geocellular tank that is designed to fit together easily to form a strong, long-lasting connection.

- Robust
- High integral strength
- Modular

**Stackable for shipping & onsite storage**

## Proven Performance Testing

### STRENGTH PERFORMANCE

Strength performance tests carried out on the ACO StormBrixx system have been conducted using methods recommended in the UK CIRIA C680 "Structural Design of Modular Geocellular Drainage Tanks." Data supplied is supported by qualified third-party independent certification.

Ultimate load-bearing capacity has been established under laboratory testing conditions during short and long-term load testing. StormBrixx meets both H-20 and HS-20 loading conditions for SD and H-25 and HS-25 loading conditions for HD.

Quality control production testing is carried out on both vertical and horizontal planes on all StormBrixx products produced.

### CREEP

Creep testing is carried out on both manufactured products and material coupons to ensure confidence in long-term performance. During a creep test, specimens are subjected to a static load. This corresponds to the load placed on the StormBrixx. The strain applied to the StormBrixx is recorded over the course of the test, which lasts 1,000 hours. Using this data, creep curves are generated, which depict the long-term behavior of plastics and lifespan of the product. Based on the data received from these tests, StormBrixx HD offers a 60-year lifespan and StormBrixx SD offers a 50-year lifespan.



### IN SITU TESTING

ACO installed a Stormbrixx SD system complete with sensors to measure vertical deflection and lateral movement. The system was covered with 24" (610 mm) of native soli with a 1" (25 mm) black top surface. The data collection during backfilling and traffic by trucks was collected, and monitored by a Leading American University. The test was witnessed by a certified test house.

A 60,000 lb (30 ton) truck was driven numerous times across the Stormbrixx system to simulate dynamic loads with no failure. The truck was also parked above the system to ensure static load requirements were met. Deflection of the system—both vertically and laterally—was deemed acceptable and compliant with H-20 load requirements.





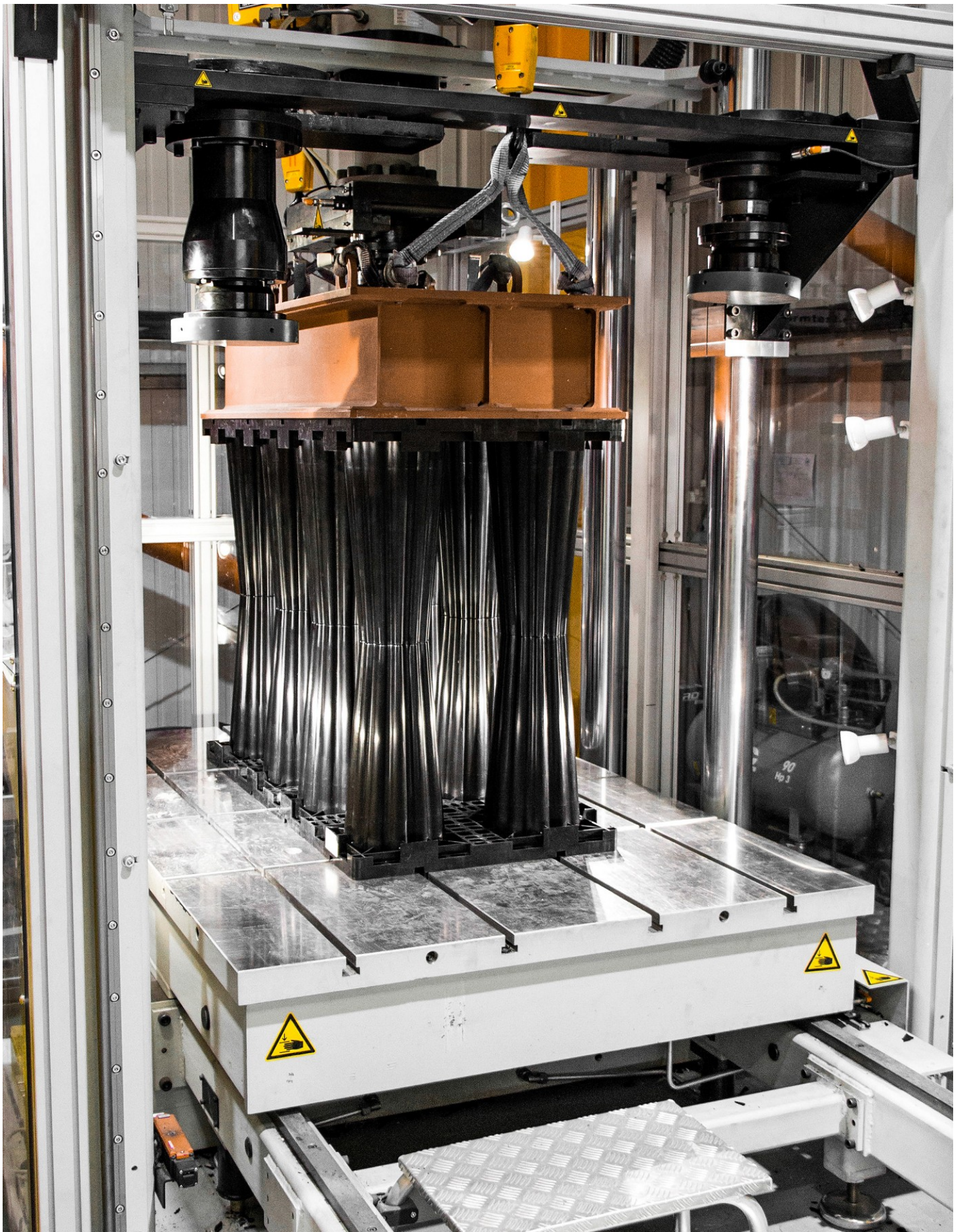



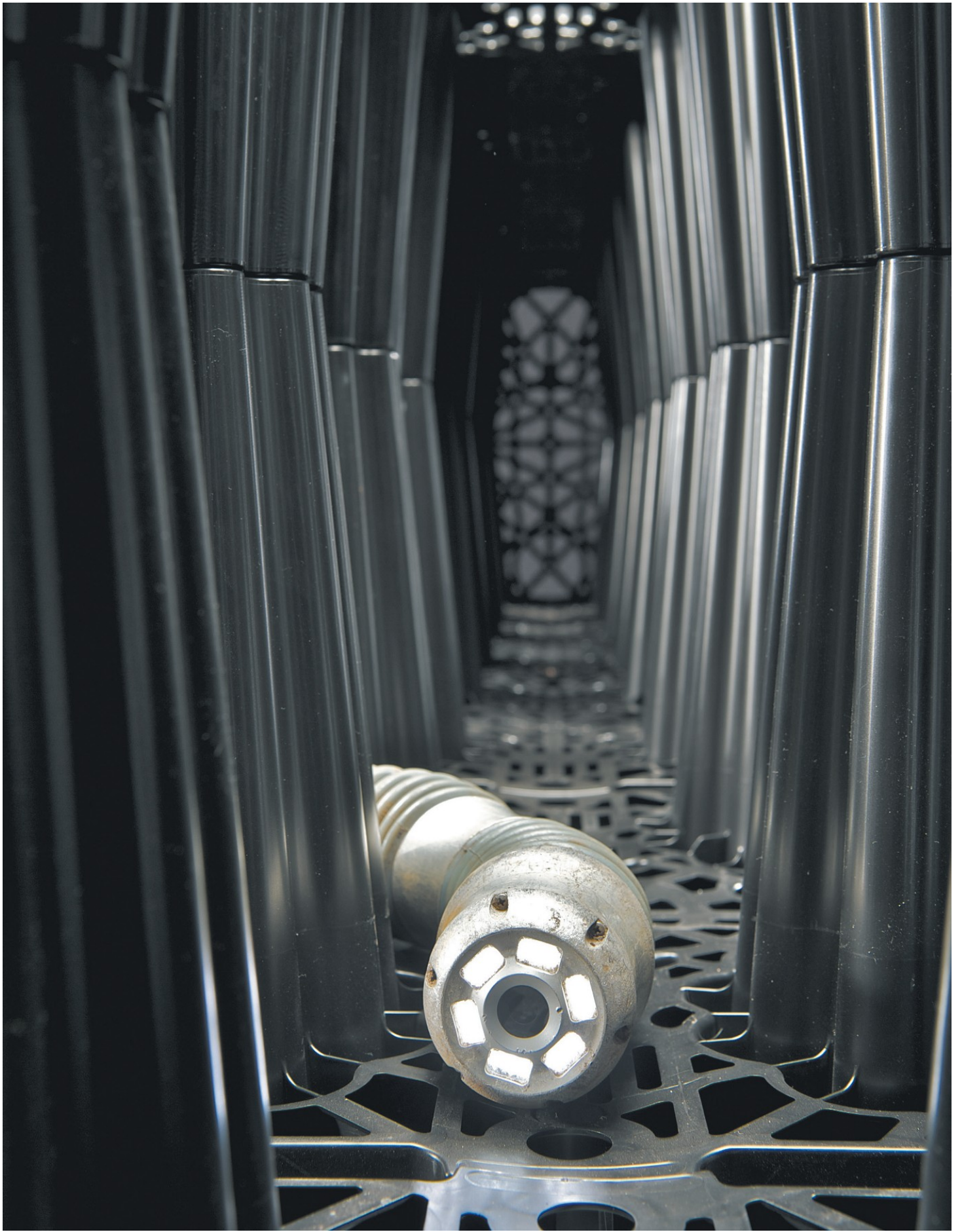



## Access & Inspection

### Open Structure for Accessibility

The open design of ACO StormBrixx allows the system to be inspected by remote CCTV either through the inlet connection, remote access units, inspection points, or pipes at the edges of the StormBrixx system. This allows the system to be inspected for sediment build-up. The collected sediment can be either removed from an infiltration system or flushed through a detention system.

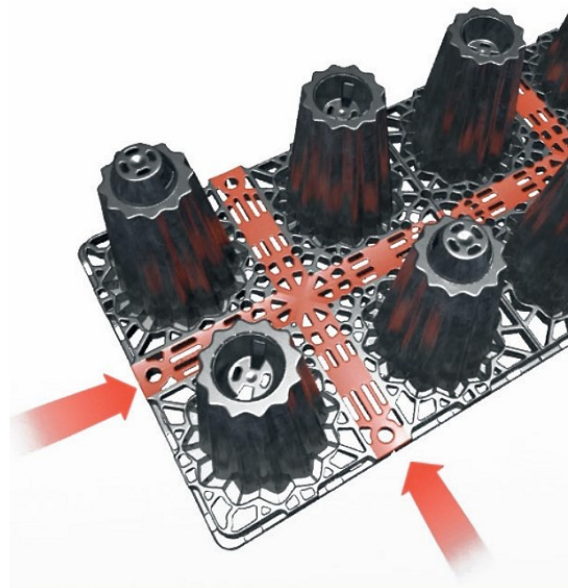

Optimum maintenance and inspection of the entire ACO StormBrixx system is possible in the longitudinal and transverse directions from minimal access points.



## Application-Driven Water Management

ACO StormBrixx SD was developed to provide a cost-effective, geocellular stormwater tank for applications where the tank will be subjected up to and including AASHTO HS-20 loading standards. These applications account for the majority of installations where the tank can be placed under landscapes, pedestrian areas, and light-duty vehicular access.



### STORMBRIXX SD SUMMARY

Half-Module Dimensions	48" (1200 mm) x 24" (600 mm) x 18" (457 mm)
Assembled Module Height	36" (914 mm)
Half-Module Weight	21.6 lbs (9.8 kg)
Pieces per Box Truck <sup>1</sup>	1404
Gross Volume per Box Truck <sup>1</sup>	16314 ft <sup>3</sup> (462 m <sup>3</sup> )
Max. Depth to Invert	14.00' (4.27 m)
Void Ratio	97%
Assembled Module Volume	Gross: 23.24 ft <sup>3</sup> (0.66 m <sup>3</sup> ) Net: 22.54 ft <sup>3</sup> (0.64 m <sup>3</sup> )
No. of Full Layers <sup>2</sup>	1-3
Vertical Strength <sup>3</sup>	7310.0 lb/ft <sup>2</sup> (350.0 kN/m <sup>2</sup> ) (50.8 psi)
Lateral Strength <sup>3</sup>	1462.0 lb/ft <sup>2</sup> (70.0 kN/m <sup>2</sup> ) (10.2 psi)
Design Life	50 years
Max Cover Depth <sup>4</sup>	6.5' (2.0 m)

- (1) 53' box truck with half-modules only. One module is created from two half-modules connected together.
- A layer is a set of modules connected together horizontally to form a tank. Extra layers may be suitable in specific applications. Please consult ACO.
- Modules only (no backfill or top covers). Supports HS-20 loading.
- Ground improvements may be required. Ground water is not taken into account.

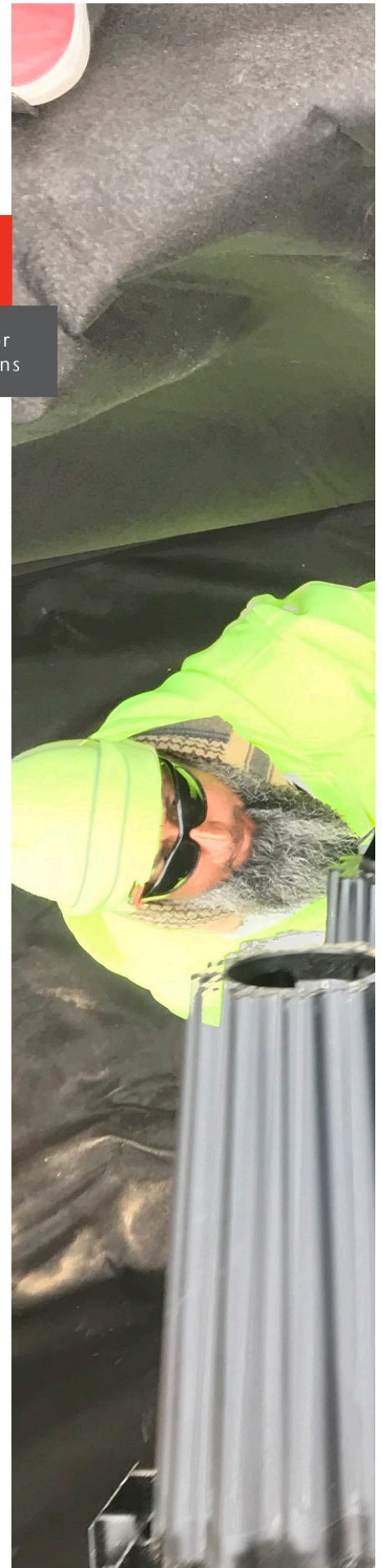



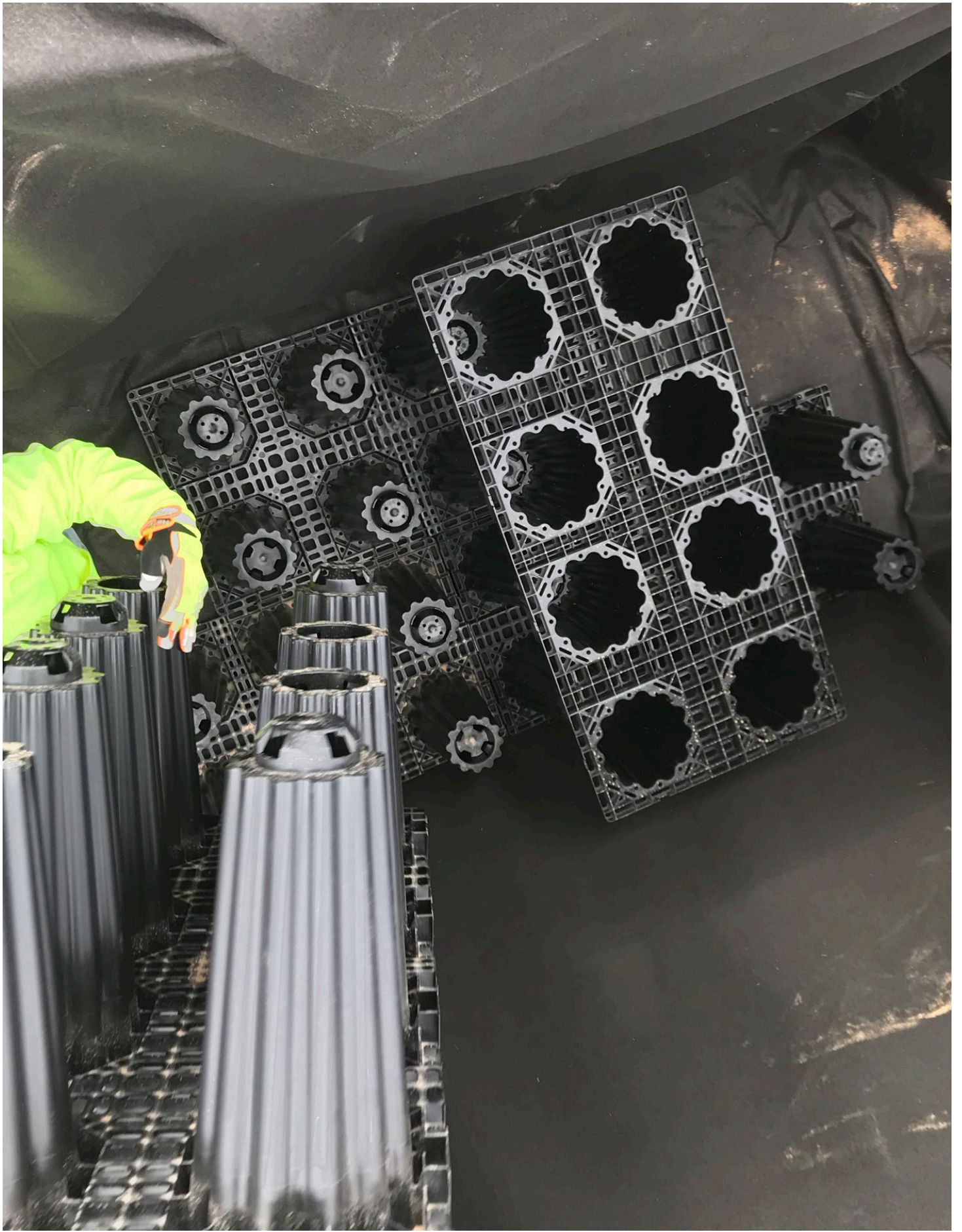

# ACO StormBrixx SD Features & Benefits

**50** YEARS  
OF ACO RELIABILITY



Recyclable polypropylene material provides a robust and corrosion-resistant basis for a long-lasting geocellular system. The modules form a loadable structure.

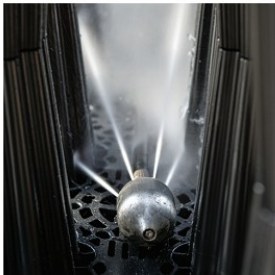

The open structure of StormBrixx SD provides free passage through the system for inspection cameras and cleaning devices.

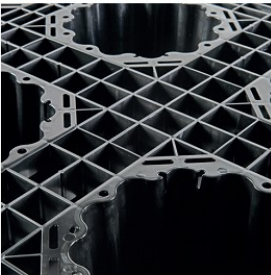

The pillars are also filled with storm water. Small openings at the base of the pillars optimize water storage in the product.



Modules can be easily cut in half to allow integration into the overall system.



### Built-in connectivity



Functional design combined with an intelligent snap-lock system make for problem-free handling and rapid installation.

### Rigid formation



Side panel perimeters for the entire system offer a sound base for laying the geotextile fabric.

### Secure brick-bonding



Modules are oriented and connected together in a pattern to create structural rigidity for the overall system.

### Half layer capability

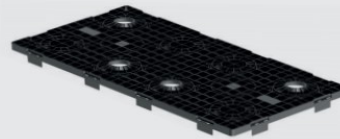

Half layers can be created by clipping the half layer top cover plate on top of a single half-module.

### STORMBRIXX SD APPLICATIONS

- Landscaped areas, no vehicles
- Landscaped areas with sit-on mowers
- Pedestrian areas
- Driveways
- Parking lots
- For applications with semi-trailers and/or high groundwater, please contact ACO

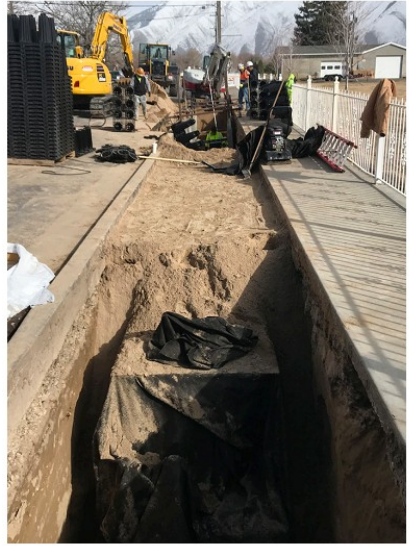





**VINCENT RIDGE DR**

Spanish Fork, UT  
United States

Installed in the subdivision expansion of Spanish Fork, UT, the ACO StormBrixx SD infiltration system was specified due to its 97% storage efficiency, providing over 8,500 ft<sup>3</sup> (240.7 m<sup>3</sup>) of storage in two separate tanks to provide the infiltration needed.

The system utilized two layers of StormBrixx SD modules in two separate tanks with access plates installed on both systems to allow for cleaning and maintenance of the system. The system was wrapped in a geotextile fabric that allowed the stormwater to naturally percolate out into the surrounding soil recharging ground water, meeting BMP requirements.

**PORTFOLIO**



# Accessories

## SD Half Layer Top Cover Plate

Not every application permits the installation of a complete layer of the ACO StormBrixx geocellular system. Areas with depth restrictions and/or high ground water levels can require the installation of a shallower system.

A top cover plate is available for StormBrixx SD for these applications, which thereby reduces the height of the layer by almost 50%.

The half layer top cover plate clicks onto a half-module in a similar manual as another half-module.

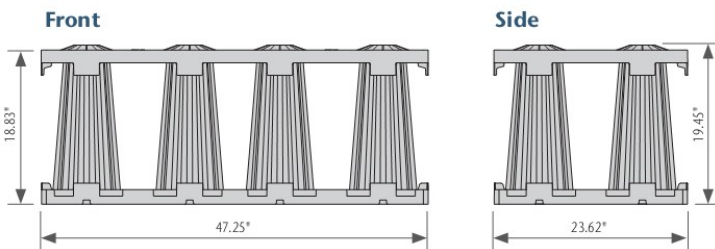
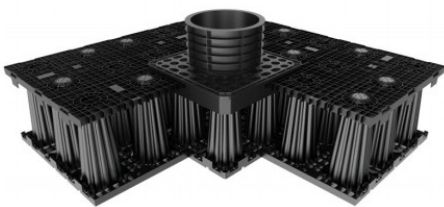
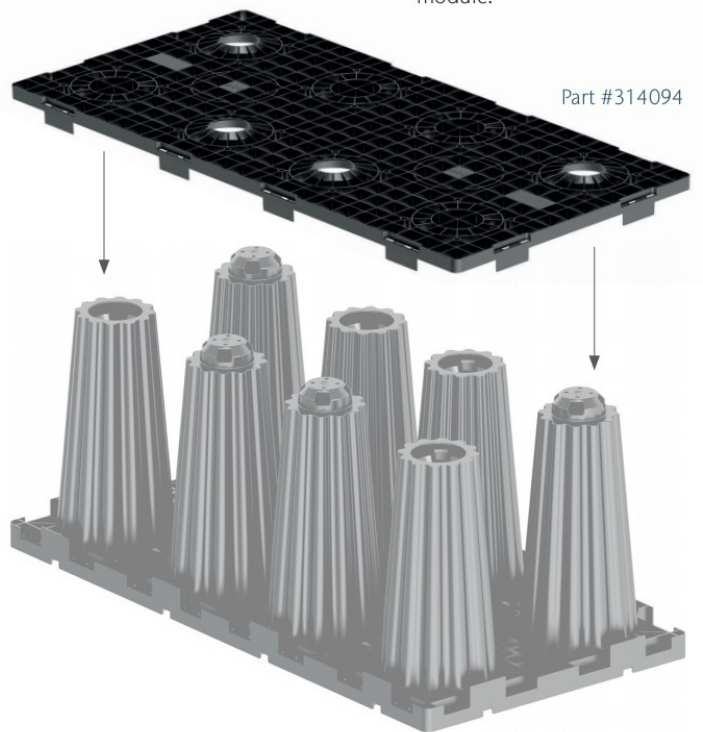



- 1 Half-module + half layer top cover plate
- 2 Module (two half-modules assembled)
- 3 Module + half-module + half layer top cover plate

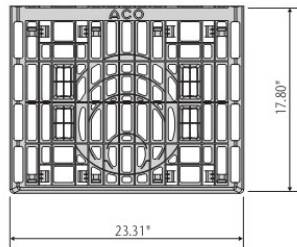
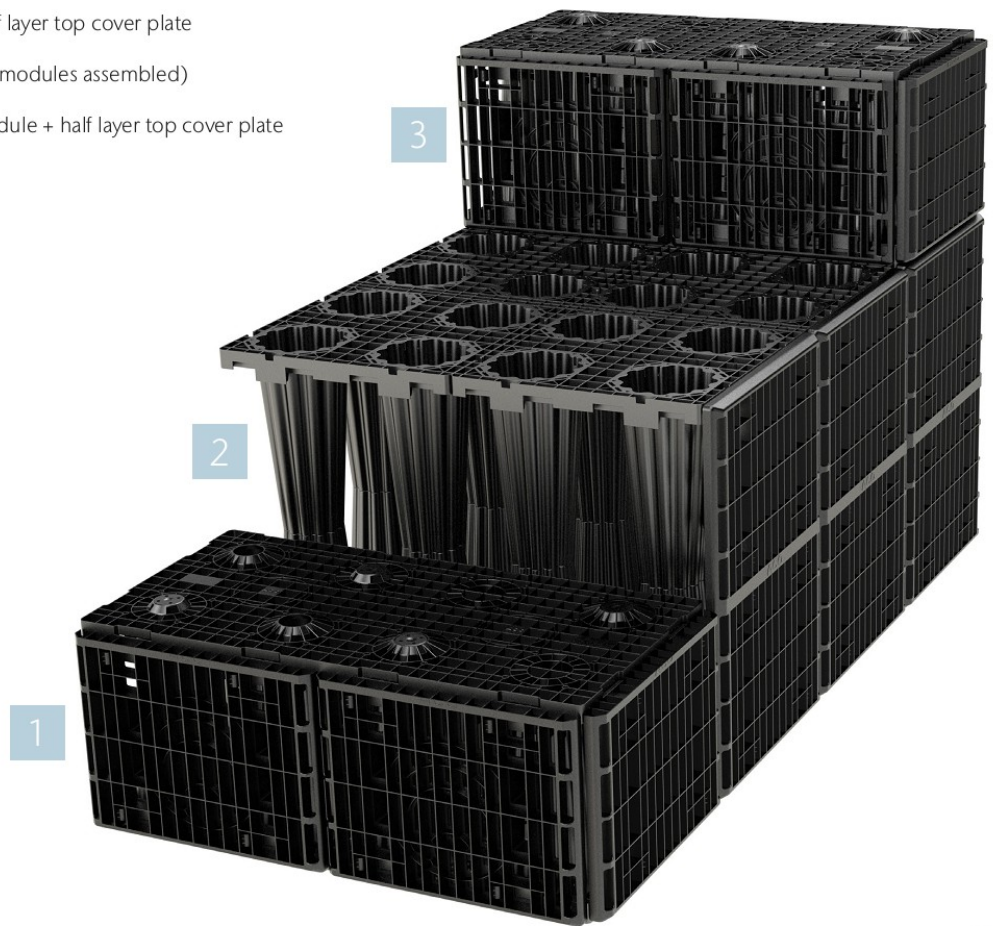

The sides of the module are enclosed with an ACO StormBrixx SD half layer side panel. On-site shortening of a full-size SD side panel is also possible.

No top covers are required if a half top cover plate is used.



## SD Remote Access Unit

The remote access unit is used to gain access to the installed ACO StormBrixx SD system.



Part #138141

Modules are cut and removed as necessary to create the space required for the remote access unit. Remote access unit walls can be removed to provide access in any direction, including the base.

**Units can be installed inside or on the edge of the structure.**



The top-most remote access units are fitted with extension shafts.

Inspection cameras or jetting heads can be inserted vertically into the extension shafts integrated within the ACO StormBrixx SD structure.

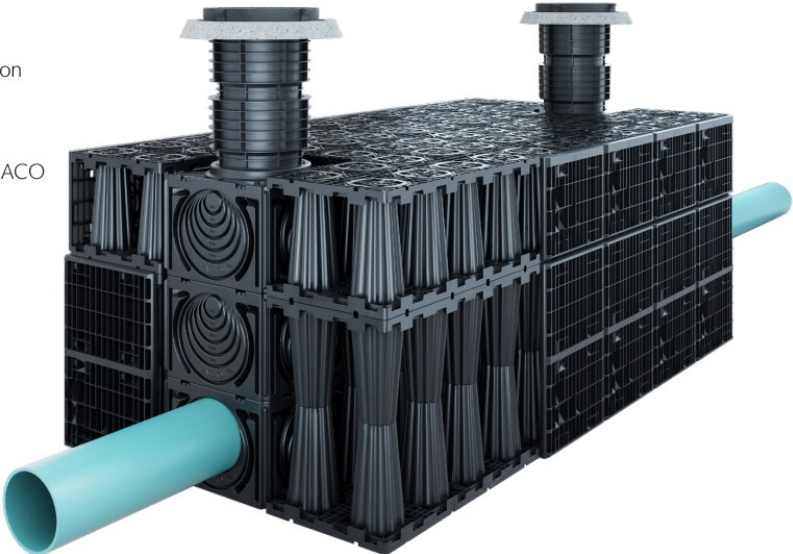



## Remote Access Plate

The remote access plate is used to gain access to an installed ACO StormBrixx SD system for inspection and/or maintenance.

Molded remote access plate; replaces one half-module



Layered modules underneath the access plate are removed to create allow free movement within the structure..

**Ensure the plate is not used on the edge of the structure; it can be used anywhere else.**



The top remote access plates are fitted with extension shafts. Inspection cameras or jetting heads can be inserted vertically through the extension shafts integrated within the StormBrixx SD structure.

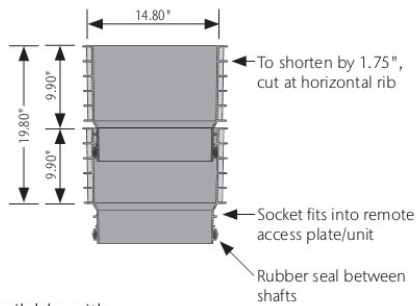
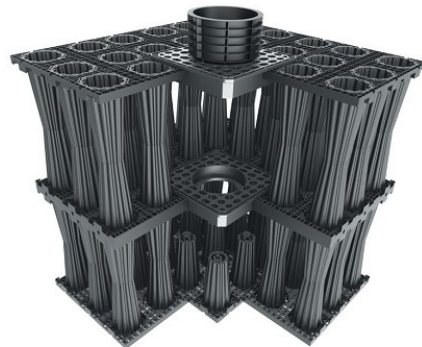

Extension shafts are available with a socket for a venting pipe (Part #314039) or without a socket (Part #314038). Extension shaft pieces can be stacked vertically.

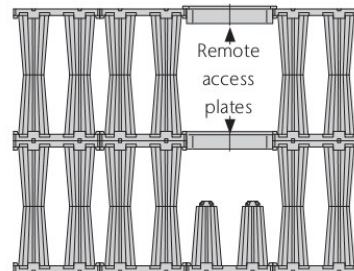

## Other Accessories

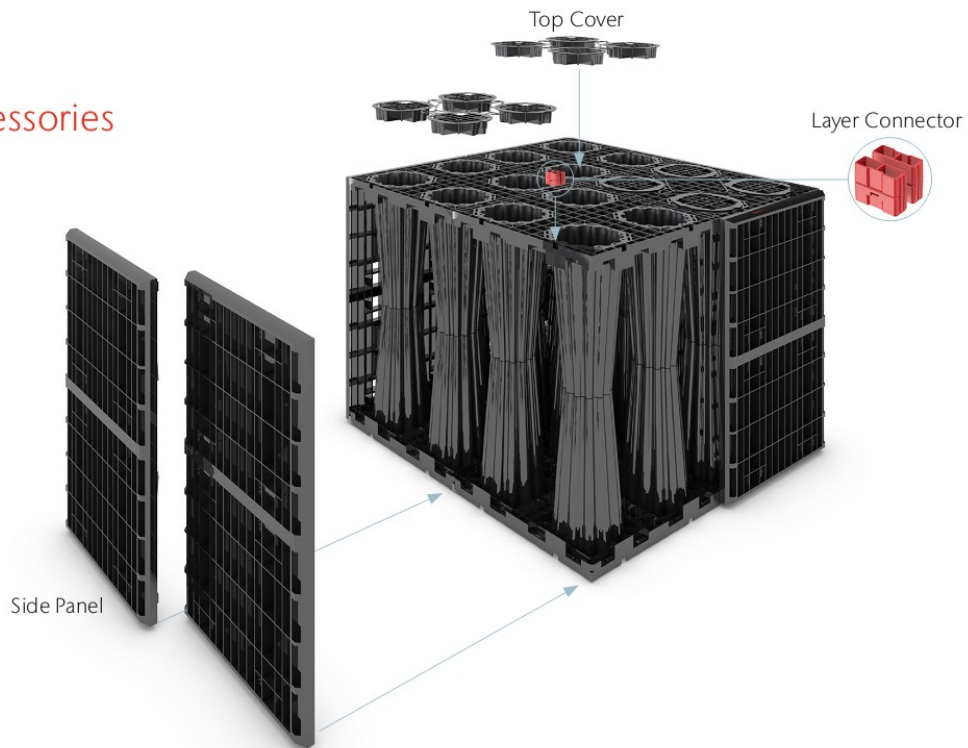

### SIDE PANELS

Side panels are placed along the outer perimeter of the geocellular StormBrixx SD system. One side panel fits one module (two assembled half-modules).

If necessary, pipe connections up to 12" (100–315 mm) can be cut out along guides molded into the panels. Pipe connections up to 18" (457 mm) can be fabricated to fit within the side panel without affecting its structural integrity.



### TOP COVERS

Top covers are used to close off the openings of the columns on the top-most layer of the geocellular system. These covers prevent ground cover material from being pushed into the columns under load.



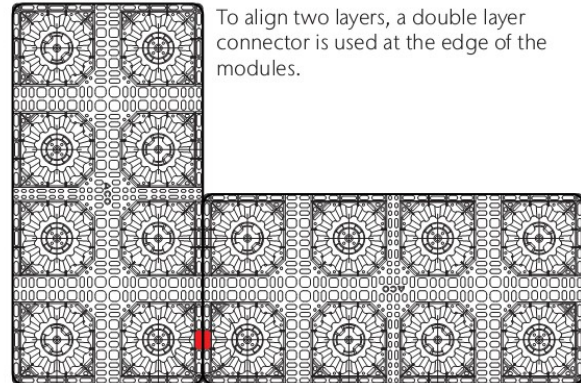
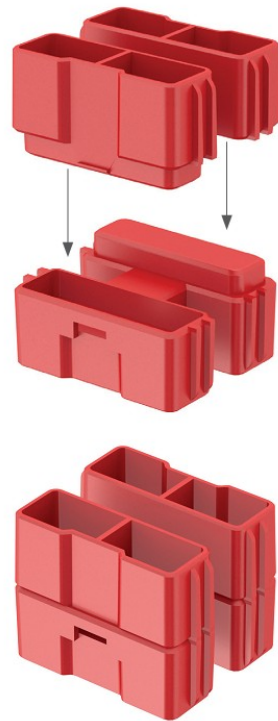

To align two layers, a double layer connector is used at the edge of the modules.

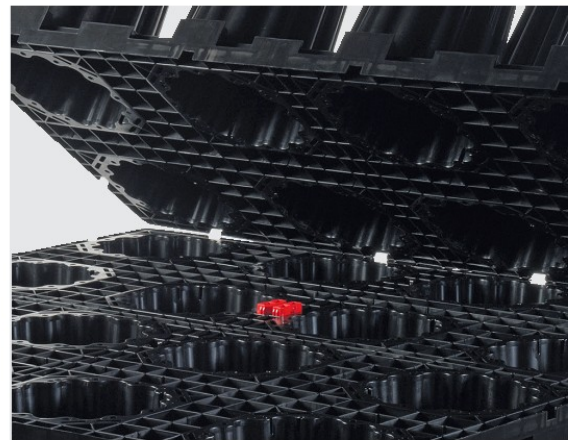
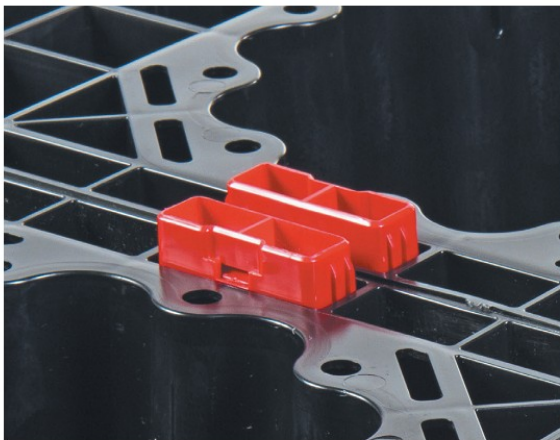

### LAYER CONNECTORS

When assembling multiple layers of ACO StormBrixx SD, the layers are aligned and secured by means of two layer connectors clicked together. The exact positions of the modules and layer connectors within the overall infiltration system are shown in the installation diagram.

The layer connectors must each be mounted in the top of the module and positioned into the molded socket next to the column on the edge of the module.

### Multiple layers

Connectors are used if two or more layers of ACO StormBrixx SD are installed:  
**Two individual layer connectors** are pushed together to form one and are inserted between the individual layers as positional fixing. This helps achieve precise alignment of the columns within several layers.

### Single layer

Unlike other geocellular systems, **no layer connectors** are required if only one layer of StormBrixx SD is installed. Orienting the modules into the system's brick-bonded pattern (see page 14) provides additional stability for the overall system.

**StormBrixx SD Parts Listing**

**SD Half-Module**

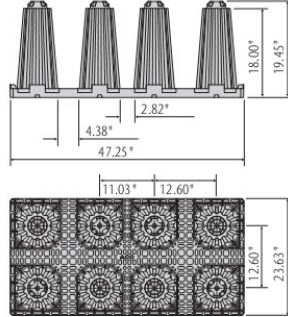

Part #	Length in [mm]	Width Overall in [mm]	Depth Overall in [mm]	Weight lbs [kg]
--------	-------------------	-----------------------------	-----------------------------	--------------------

<b>314090</b>	47.24 [1200]	23.62 [600]	19.45 [494]	21.60 [9.80]
---------------	-----------------	----------------	----------------	-----------------

**SD Side Panel**

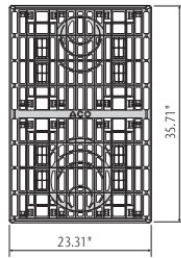

<b>314091</b>	35.71 [907]	23.31 [592]	4.10 [104]	7.20 [3.30]
---------------	----------------	----------------	---------------	----------------

**SD Top Cover**

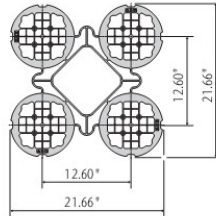

<b>314092</b>	21.65 [550]	21.65 [550]	1.96 [50]	1.60 [0.70]
---------------	----------------	----------------	--------------	----------------

**SD Layer Connector**

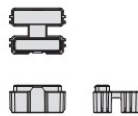

<b>314093</b>	2.11 [54]	1.75 [44]	1.05 [27]	0.03 [0.02]
---------------	--------------	--------------	--------------	----------------





StormBrixx SD Parts Listing

Remote Access Plate

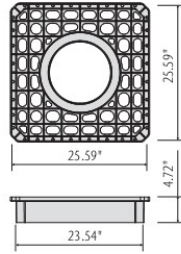

Part #	Length in [mm]	Width Overall in [mm]	Depth Overall in [mm]	Weight lbs [kg]
--------	-------------------	-----------------------------	-----------------------------	--------------------

314075	25.59 [650]	25.59 [650]	4.72 [120]	10.78 [4.90]
--------	----------------	----------------	---------------	-----------------

SD Remote Access Unit

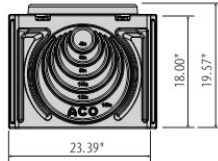

138141	23.39 [594]	23.39 [594]	19.57 [497]	40.0 [18.14]
--------	----------------	----------------	----------------	-----------------

SD Half Layer Top Cover Plate

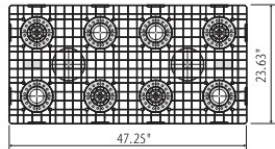

314094	47.25 [1200]	23.63 [600]	3.70 [94]	7.70 [3.50]
--------	-----------------	----------------	--------------	----------------

SD Half Layer Side Panel

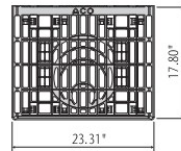

314098	17.85 [453]	23.31 [592]	4.10 [104]	3.30 [1.50]
--------	----------------	----------------	---------------	----------------

**StormBrixx SD Parts Listing**

**Remote Access Cover - Ductile Iron (Load Class D400 - 40 Ton)**

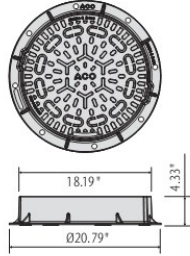

Part #	Length in [mm]	Width Overall in [mm]	Depth Overall in [mm]	Weight lbs [kg]
--------	-------------------	-----------------------------	-----------------------------	--------------------

314043

-

Ø20.79  
[528]

4.33  
[110]

86.46  
[39.30]

**Remote Access Vented Cover - Ductile Iron (Load Class D400 - 40 Ton)**

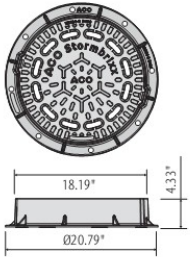

314053

-

Ø20.79  
[528]

4.33  
[110]

83.60  
[38.00]

**Inspection Point Cover - Ductile Iron (Load Class D400 - 40 Ton)**

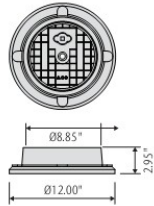

314044

-

Ø8.85\*  
[225]

2.95  
[75]

34.54  
[15.70]

\*Internal Width





StormBrixx SD Parts Listing

	Part #	Length in [mm]	Width Overall in [mm]	Depth Overall in [mm]	Weight lbs [kg]	
<b>Extension Shaft</b>						
		<b>314038</b>	-	Ø17.21 [437]	13.78 [350]	4.84 [2.60]
<b>Extension Shaft with Pipe Socket</b>						
		<b>314039</b>	-	Ø17.21 [437]	13.78 [350]	6.16 [2.80]
<b>Vertical Inspection Point Connector</b>						
		<b>27018</b>	-	Ø8.85* [225]	7.87 [200]	5.52 [2.50]
<b>Horizontal Pipe Connectors</b>						
		<b>93139</b>	8.00 [203]	Ø4.00* [102] (SDR 35)	6.70 [170]	1.93 [0.88]
		<b>93145</b>	8.00 [203]	Ø4.00* [102] (SCH 40)	6.70 [170]	1.93 [0.88]
		<b>93140</b>	8.00 [203]	Ø6.00* [152] (SDR 35)	10.22 [260]	3.29 [1.49]
		<b>93146</b>	8.00 [203]	Ø6.00* [152] (SCH 40)	10.22 [260]	3.29 [1.49]
		<b>93141</b>	8.00 [203]	Ø8.00* [203] (SDR 35)	11.64 [296]	4.40 [2.00]
		<b>93147</b>	8.00 [203]	Ø8.00* [203] (SCH 40)	11.64 [296]	4.31 [1.95]
		<b>93142</b>	8.00 [203]	Ø12.00* [305] (SDR 35)	16.66 [423]	7.00 [3.18]
		<b>93144</b>	8.00 [203]	Ø15.00* [381] (SDR 35)	21.71 [551]	10.80 [4.90]

\*Internal Width







## TOOELE POLICE STATION

Tooele, UT  
United States

Two layers of ACO StormBrixx SD modules and three access locations were installed at this Utah police station to ensure ease of access and to help simplify routine maintenance procedures.

Two ACO StormBrixx SD systems were installed in less than 36 hours, minimizing any hindrances towards the efficiency of an active police station.

PORTFOLIO



## ACO StormBrixx HD

Stormwater Management for  
Heavy Duty Traffic Applications

### High-Strength Plastic Geocellular System

ACO StormBrixx HD was developed to provide a plastic geocellular product that can support heavy loads and heavy duty applications. StormBrixx HD addresses problems many other products encounter in these applications while ensuring a long life with no failures.



#### STORMBRIXX HD SUMMARY

Half-Module Dimensions	47.44" (1205 mm) x 23.70" (602 mm) x 12.00" (305 mm)
Assembled Module Height	24" (610 mm)
Half-Module Weight	22.4 lbs (10.2 kg)
Pieces per Box Truck <sup>1</sup>	1368
Gross Volume per Box Truck <sup>1</sup>	10609 ft <sup>3</sup> (300.4 m <sup>3</sup> )
Max. Depth to Invert	19.7' (6 m)
Void Ratio	95%
Assembled Module Volume	Gross: 15.51 ft <sup>3</sup> (0.44 m <sup>3</sup> ) Net: 14.73 ft <sup>3</sup> (0.42 m <sup>3</sup> )
No. of Full Layers <sup>2</sup>	1-4
Vertical Strength <sup>3</sup>	9502.9 lb/ft <sup>2</sup> (455.0 kN/m <sup>2</sup> ) (66 psi)
Lateral Strength <sup>3</sup>	1984.2 lb/ft <sup>2</sup> (95.0 kN/m <sup>2</sup> ) (13.8 psi)
Design Life	60 years
Max Cover Depth <sup>4</sup>	11.16' (3.4 m)

- (1) 53' box truck with half-modules only. One module is created from two half-modules connected together.
- A layer is a set of modules connected together horizontally to form a tank. Extra layers may be suitable in specific applications. Please consult ACO.
- Modules only (no backfill or top covers). Supports HS-25 loading.
- Ground improvements may be required. Ground water is not taken into account.

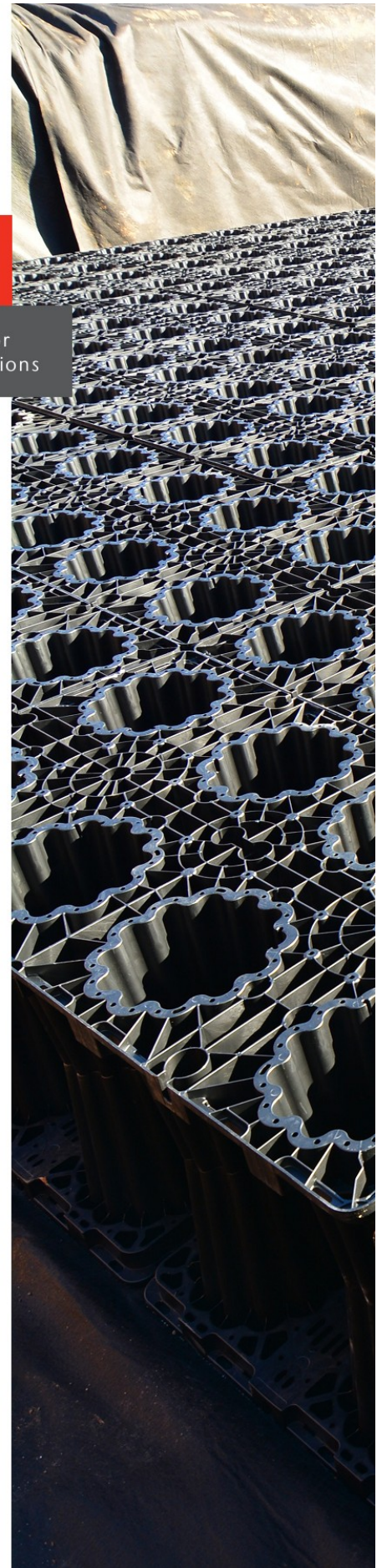







# ACO StormBrixx HD Features & Benefits

**60 YEARS**  
OF ACO RELIABILITY



Units are molded with 5% recycled material. Recyclable polypropylene material provides a robust and corrosion-resistant basis for a long-lasting geocellular system. The modules form a loadable structure.



The open structure of ACO StormBrixx HD provides free passage through the system for inspection cameras and cleaning devices.



The pillars are also filled with stormwater. Small openings at the base of the pillars optimize water storage in the product.



Modules can be easily cut in half to allow integration into the overall system.



### Built-in connectivity

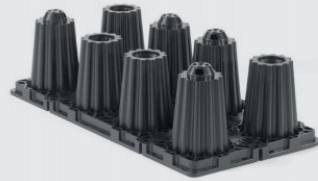

Functional design combined with an intelligent snap-lock system make for problem-free handling and rapid installation.

### Rigid formation

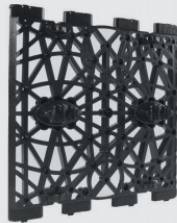

Side panel perimeters for the entire system offer a sound base for laying the geotextile fabric.

### Secure brick-bonding



Modules are oriented and connected together in a pattern to create structural rigidity for the overall system.

#### STORMBRIXX HD APPLICATIONS

- Landscaped areas, no vehicles
- Landscaped areas with sit-on mowers
- Pedestrian areas
- Driveways
- Parking lots
- Solid pavement required for fire trucks, delivery vehicles, and semi-trailers up to 29.5' (9 m) long
- For applications with heavy duty vehicles and/or high ground water, please contact ACO

## Accessories



Part #27034

Modules are cut and removed as necessary to create the free space required for the remote access unit. Remote access unit walls can be removed to provide access in any direction, including the base.

**Remote access units can be installed inside or on the edge of the structure.**

### HD Remote Access Unit

The remote access unit is used to gain access to the installed ACO StormBrixx HD system.



The top-most remote access units are fitted with extension shafts.

Inspection cameras or jetting heads can be inserted vertically into the extension shafts integrated within the ACO StormBrixx HD structure.





## Remote Access Plate

The remote access plate is used to gain access to the installed ACO StormBrixx HD system.

Molded remote access plate; replaces one half-module



Part #314075

The top-most remote extension shafts are fitted with access chambers. Inspection cameras or jetting heads can be inserted vertically into the extension shafts integrated within the StormBrixx HD structure.

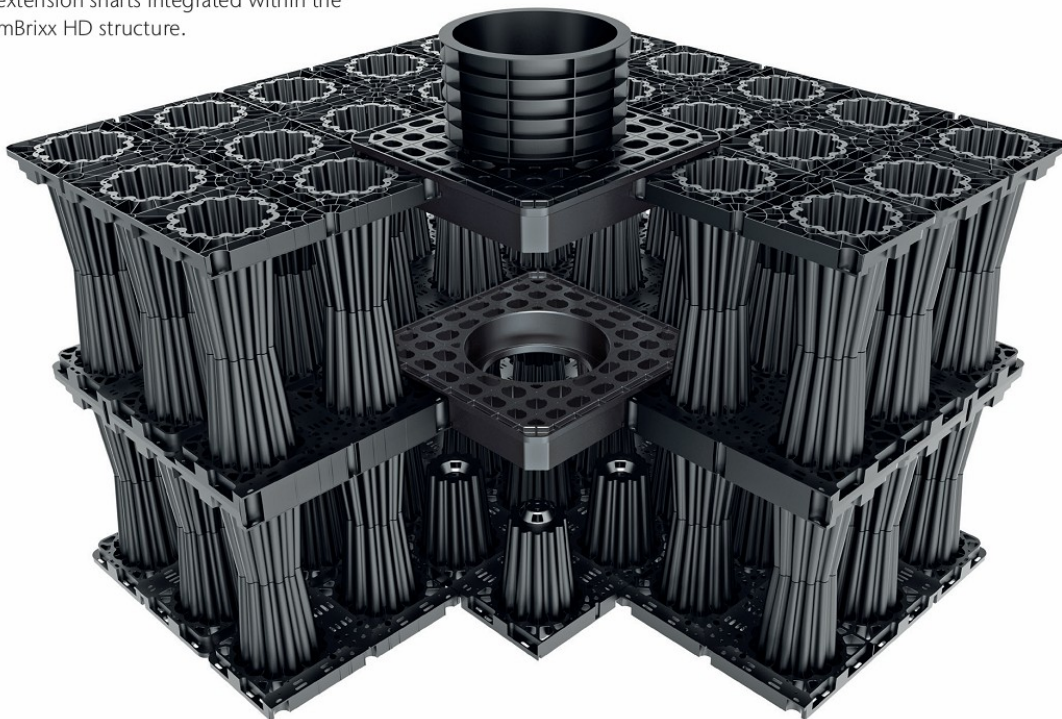

Layered modules are removed to allow free movement within the structure.

**Ensure the plate is not used on the edge of the structure; it can be used anywhere else.**

## Other Accessories

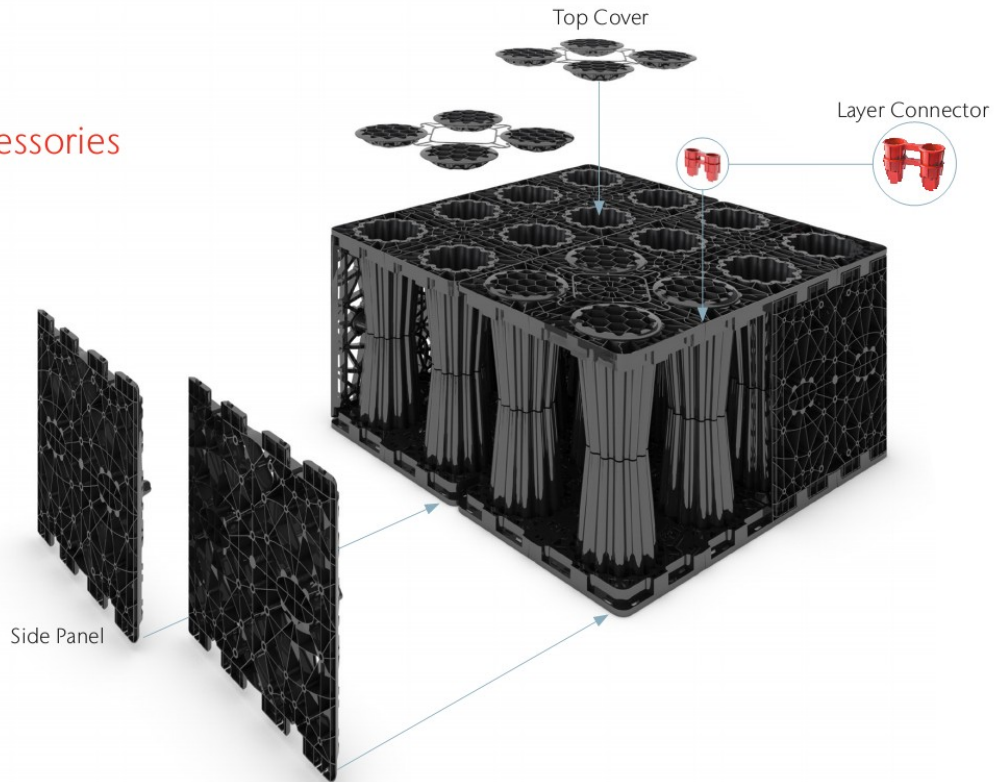

### **SIDE PANELS**

Side panels are placed along the outer perimeter of the geocellular system. One side panel fits one module (two assembled half-modules).

If necessary, pipe connections up to 12" (100–315 mm) can be cut out along guides molded onto the panels.



### **TOP COVERS**

Top covers are used to close off the openings of the columns on the top-most layer of the geocellular system. These covers prevent ground cover material from being pushed into the columns under load.



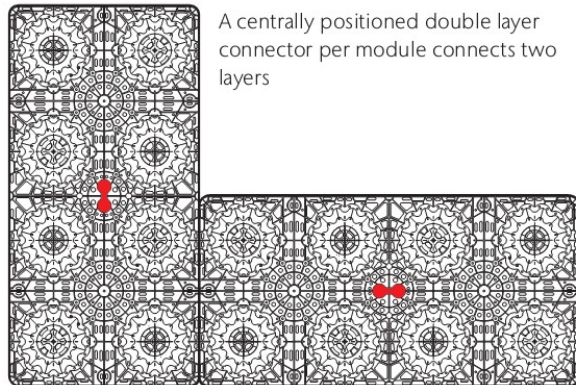
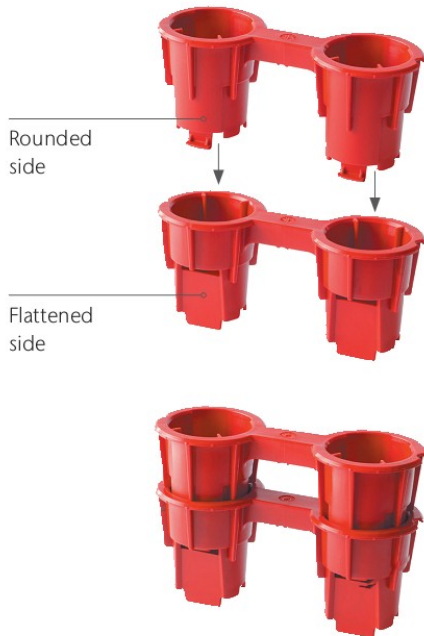

### LAYER CONNECTORS

When assembling multiple layers of ACO StormBrixx HD, the layers are aligned and secured by means of two layer connectors clicked together. The exact positions of the modules and layer connectors within the overall infiltration system are shown in the installation diagram.

The layer connectors must each be mounted in the top of the module and positioned into the molded socket next to the column on the edge of the module.

### Multiple layers

Connectors are used if two or more layers of ACO StormBrixx HD are installed:  
**Two individual layer connectors** are pushed together to form one and are inserted between the individual layers as positional fixing. This helps achieve precise alignment of the columns within several layers.

### Single layer

Unlike other geocellular systems, **no layer connectors** are required if only one layer of StormBrixx HD is installed. Orienting the modules into the system's brick-bonded pattern (see page 14) provides additional stability for the overall system.

**StormBrixx HD Parts Listing**

**HD Half-Module**

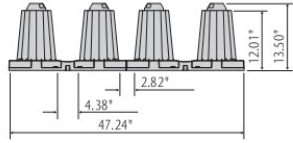

Part #	Length in [mm]	Width Overall in [mm]	Depth Overall in [mm]	Weight lbs [kg]
--------	-------------------	-----------------------------	-----------------------------	--------------------

**314061**

47.44  
[1205]

23.70  
[602]

13.50  
[343]

22.40  
[10.20]

**HD Side Panel**

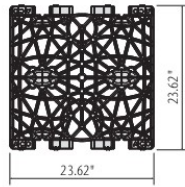
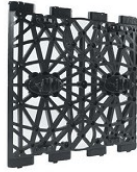

**314062**

23.62  
[600]

23.62  
[600]

2.17  
[55]

3.79  
[1.72]

**HD Top Cover**

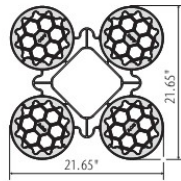

**314022**

21.57  
[548]

21.57  
[548]

1.70  
[43]

1.79  
[0.81]

**HD Layer Connector**

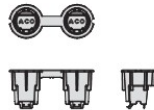

**314023**

3.94  
[100]

1.58  
[40]

1.82  
[46]

0.03  
[0.02]

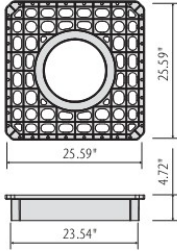

StormBrixx HD Parts Listing

		Part #	Length in [mm]	Width Overall in [mm]	Depth Overall in [mm]	Weight lbs [kg]
<b>Remote Access Plate</b>						
		<b>314075</b>	25.59 [650]	25.59 [650]	4.72 [120]	10.78 [4.90]
<b>HD Remote Access Unit</b>						
		<b>27034</b>	23.39 [594]	23.39 [594]	24.02 [610]	70.50 [31.98]
<b>HD Remote Access Unit with Adapter Plate</b>						
		<b>138140</b>	24.41 [620]	23.39 [594]	24.02 [610]	71.00 [32.20]



**StormBrixx HD Parts Listing**

**Remote Access Cover - Ductile Iron (Load Class D400 - 40 Ton)**

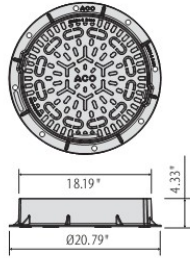

Part #	Length in [mm]	Width Overall in [mm]	Depth Overall in [mm]	Weight lbs [kg]
--------	-------------------	-----------------------------	-----------------------------	--------------------

314043

-

Ø20.79  
[528]

4.34  
[110]

86.46  
[39.30]

**Remote Access Vented Cover - Ductile Iron (Load Class D400 - 40 Ton)**

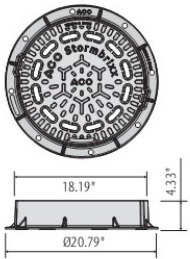

314053

-

Ø20.79  
[528]

4.34  
[110]

83.60  
[38.00]

**Inspection Point Cover - Ductile Iron (Load Class D400 - 40 Ton)**

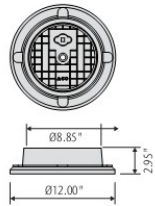

314044

-

Ø8.85\*  
[225]

2.95  
[75]

34.54  
[15.70]

\*Internal Width



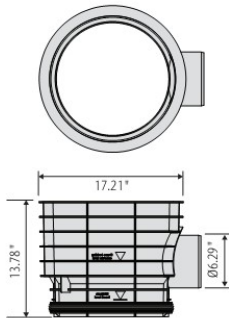
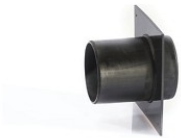

StormBrixx HD Parts Listing

	Part #	Length in [mm]	Width Overall in [mm]	Depth Overall in [mm]	Weight lbs [kg]	
<b>Extension Shaft</b>						
		<b>314038</b>	-	Ø17.21 [437]	13.78 [350]	4.84 [2.60]
<b>Extension Shaft with Pipe Socket</b>						
		<b>314039</b>	-	Ø17.21 [437]	13.78 [350]	6.16 [2.80]
<b>Vertical Inspection Point Connector</b>						
		<b>27018</b>	-	Ø8.85* [225]	7.87 [200]	5.52 [2.50]
<b>Horizontal Pipe Connectors</b>						
		<b>93139</b>	8.00 [203]	Ø4.00* [102] (SDR 35)	6.70 [170]	1.93 [0.88]
		<b>93145</b>	8.00 [203]	Ø4.00* [102] (SCH 40)	6.70 [170]	1.93 [0.88]
		<b>93140</b>	8.00 [203]	Ø6.00* [152] (SDR 35)	10.22 [260]	3.29 [1.49]
		<b>93146</b>	8.00 [203]	Ø6.00* [152] (SCH 40)	10.22 [260]	3.29 [1.49]
		<b>93141</b>	8.00 [203]	Ø8.00* [203] (SDR 35)	11.64 [296]	4.40 [2.00]
		<b>93147</b>	8.00 [203]	Ø8.00* [203] (SCH 40)	11.64 [296]	4.31 [1.95]
		<b>93142</b>	8.00 [203]	Ø12.00* [305] (SDR 35)	16.66 [423]	7.00 [3.18]
		<b>93144</b>	8.00 [203]	Ø15.00* [381] (SDR 35)	21.71 [551]	10.80 [4.90]

\*Internal Width







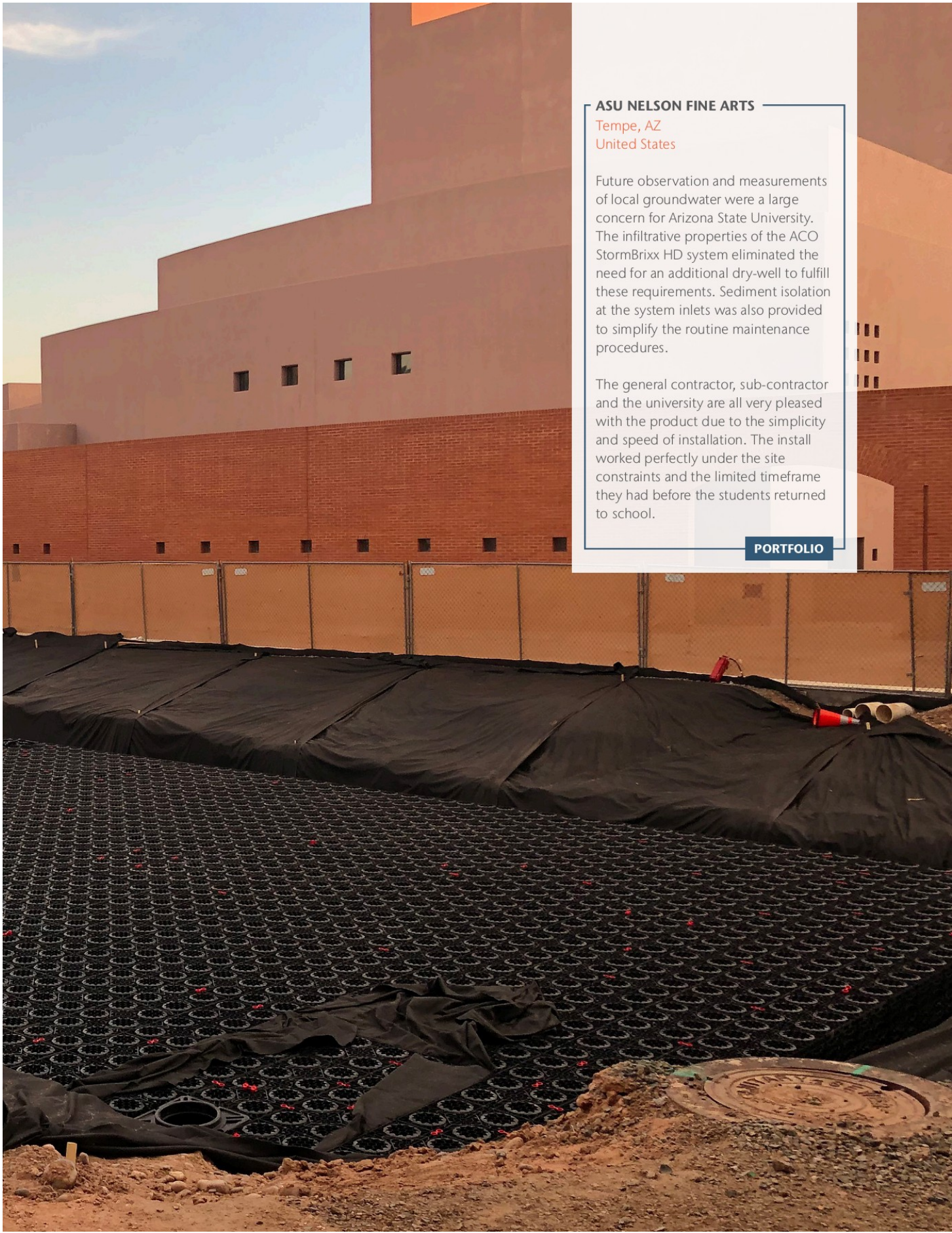

**ASU NELSON FINE ARTS**

Tempe, AZ  
United States

Future observation and measurements of local groundwater were a large concern for Arizona State University. The infiltrative properties of the ACO StormBrixx HD system eliminated the need for an additional dry-well to fulfill these requirements. Sediment isolation at the system inlets was also provided to simplify the routine maintenance procedures.

The general contractor, sub-contractor and the university are all very pleased with the product due to the simplicity and speed of installation. The install worked perfectly under the site constraints and the limited timeframe they had before the students returned to school.

**PORTFOLIO**



## ACO Flow Control

For Independent Use or with  
ACO StormBrixx Systems

### Fully Integrated Stormwater Control

ACO's range of flow control systems are designed to regulate stormwater flow before it discharges into the watercourse or storm sewer networks.

ACO Q-Brake Vortex flow controls and ACO Q-Plate orifice plates are capable of regulating any flow for surface water applications and can be used in conjunction with ACO StormBrixx as an integrated Sustainable Drainage scheme.



#### FLOW CONTROL SUMMARY

<b>Q-Brake Vortex</b>	Stainless steel, horizontal, vortex flow control device
<b>Q-Plate</b>	Stainless steel orifice plate flow control device which can operate with or without a remote bypass







961

22.3

0.23

# ACO Flow Control Features & Benefits

Storage and the controlled release of clean water into the natural environment is an important aspect of managing surface water in a sustainable drainage approach. Overall responsibility often belongs to the local regulatory body to impose, where appropriate, the discharge rate of a surface water flow control system.

ACO's flow control systems can be used in conjunction with ACO StormBrixx to provide a fully integrated stormwater control system to meet the requirements of the regulations.

The diagram explains how the StormBrixx system is used to provide stormwater detention, while the ACO Q-Brake Vortex is used to regulate the rate of discharge into the storm sewer network or watercourse.

Compared to the use of traditional flow control systems, the combination of StormBrixx and Q-Brake Vortex can reduce the need for additional upstream storage, lowering overall installation and maintenance costs.

This benefit is best demonstrated in the example shown here. The conclusion of the example means that upstream storage can be reduced by 388.5 ft<sup>3</sup> (11.0 m<sup>3</sup>) compared to using a traditional flow control system.

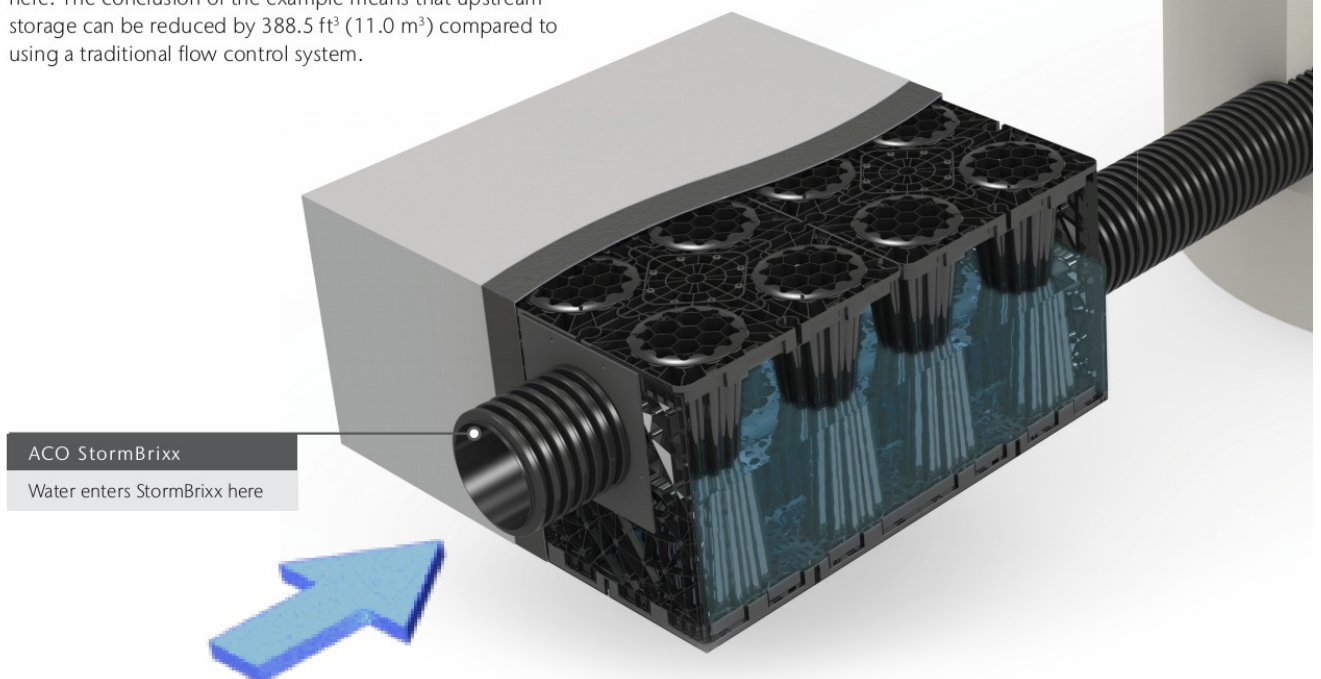



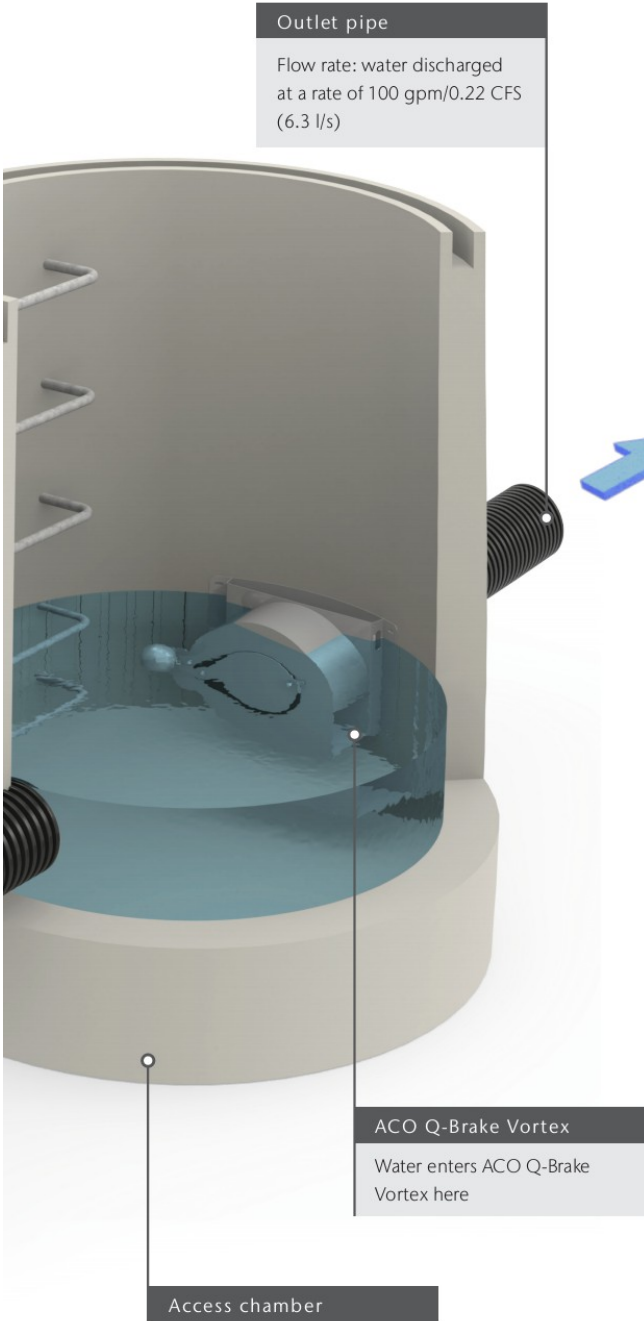

**Example:**

A project in Denver, CO has a catchment area of 139,930.8 ft<sup>2</sup> (13,000 m<sup>2</sup>). The project has design criteria of a one-in-30 year storm and the runoff from the site must not exceed 100 gpm/0.22 CFS (6.3 l/s) at a design head of 51.2" (1.3 m).

**Results:**

Using MicroDrainage® software, ACO compared upstream storage requirements using ACO Q-Brake Vortex and a traditional orifice plate. Results are summarized below:

- Q-Brake Vortex required Ø3.54" (90 mm). Upstream attenuation required 14,196.5 ft<sup>3</sup> (402.0 m<sup>3</sup>).
- Orifice plate size required Ø2.0" (51 mm). Upstream attenuation required 14585.0 ft<sup>3</sup> (413.0 m<sup>3</sup>). Q-Brake Vortex reduces upstream attenuation by 388.5 ft<sup>3</sup> (11.0 m<sup>3</sup>) while having an orifice over three times the area of the traditional orifice plate, making Q-Brake Vortex more efficient and far less prone to blockage.

**Discharge characteristics:**

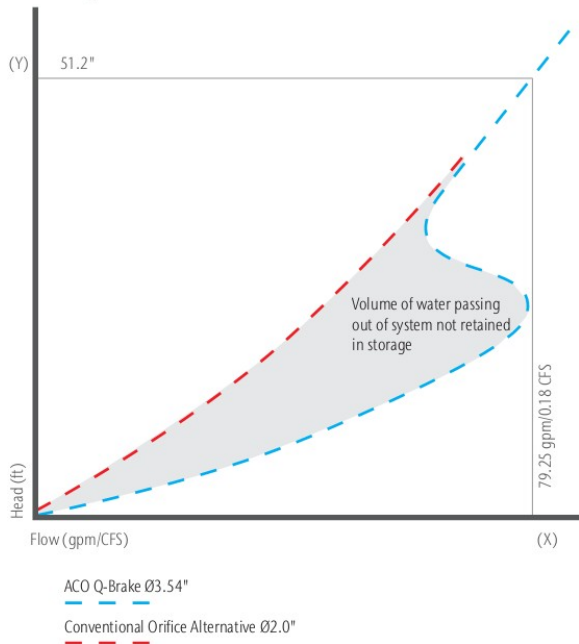

# ACO Q-Brake Vortex

## What is ACO Q-Brake Vortex?

ACO Q-Brake Vortex is a horizontal vortex flow control designed to regulate stormwater flows from 31.7–1,585.0/0.07 CFS - 3.53 CFS gpm (2-100 l/s). Manufactured from grade 304 stainless steel, each Q-Brake Vortex is individually configured to suit specific performance criteria.

The design of a vortex flow control is based on the fluid mechanics principle of the forced vortex, which permits flow regulation without any moving parts.

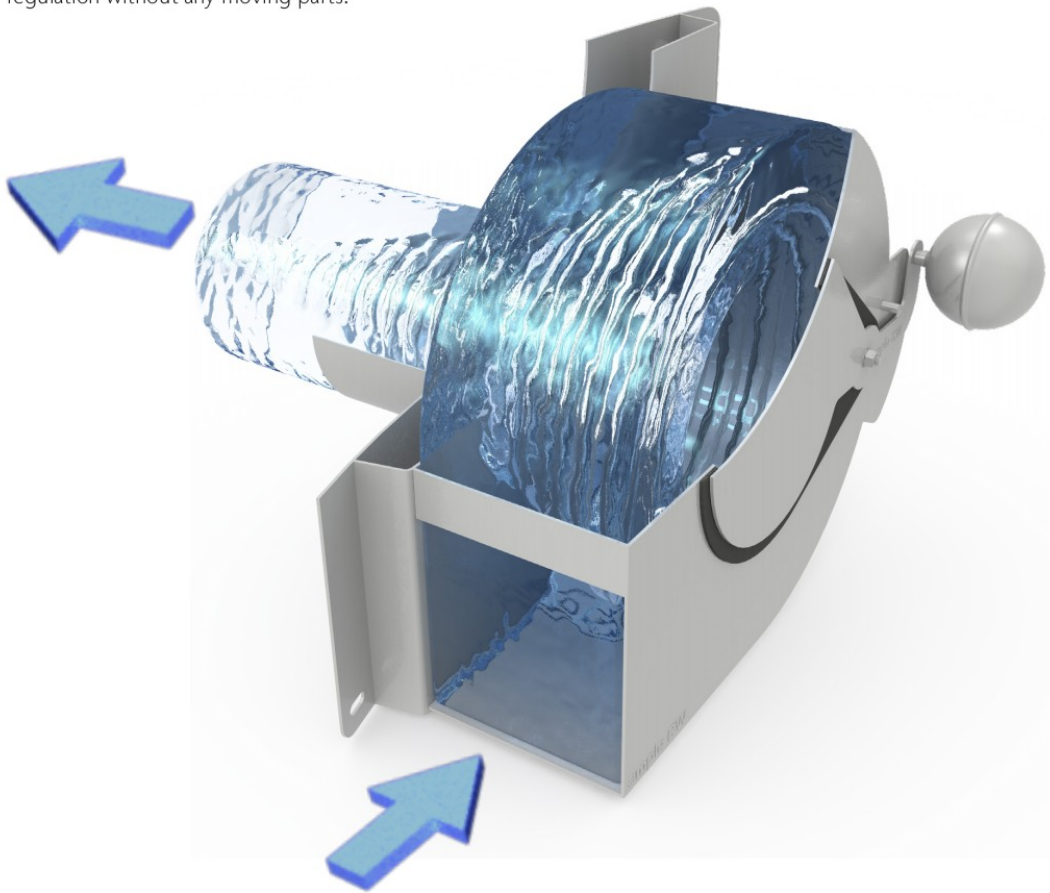

ACO Q-Brake Vortex utilizes the upstream head and discharge to generate a vortex within the structure of the unit. The water is then released at a pre-determined controlled rate preventing downstream flooding.

Unlike more conventional methods, Q-Brake Vortex is less prone to blockage, and permits higher flow at a lower head of water, as a vortex control allows an outlet 4-6 times larger in cross sectional area to be used.



## Why choose ACO Q-Brake Vortex?

### Planning and connection

ACO Q-Brake Vortex addresses the planning and connection requirements when a discharge restriction is needed. Q-Brake Vortex regulates surface water flow to the specified rate of discharge.

### Tailored performance

Each ACO Q-Brake Vortex is tailored to the specific performance requirements of the application, providing optimum efficiency within the system.

### Optimum hydraulic efficiency

The mechanism employed within ACO Q-Brake Vortex provides superior hydraulic performance in comparison to traditional flow control systems.

### Proven performance

ACO Q-Brake Vortex is independently laboratory-tested to verify discharge rates.

### MicroDrainage

ACO Q-Brake Vortex can be sized and modeled on the latest version of the MicroDrainage® design software and can be incorporated into the overall hydraulic drainage design.

### Ease of installation

Each ACO Q-Brake Vortex unit is custom built to suit the profile of the chamber. Radius fixing options remove the need for additional benching - simplifying installation and reducing cost.

### Reduces total installed cost

ACO Q-Brake Vortex allows more flow at lower hydraulic heads, reducing the need for on-site storage volume requirements and lowering installation costs.

### Access and maintenance

ACO Q-Brake Vortex has large, clear openings making it less prone to blockage. An absence of loose parts reduces maintenance requirements.

The patented bypass door and emergency drain down facility allows Q-Brake Vortex to be remotely accessed from the surface to allow the upstream system to be independently drained, completely bypassing the inlet.

## ACO Q-Brake Vortex Features & Benefits

Note: Q-Brake body to suit circular access shaft shown



Note: Q-Brake body to suit flat wall access shaft shown





# ACO Q-Brake Vortex Specification & Design Process

Manufactured from grade 304 stainless steel, each ACO Q-Brake Vortex is individually configured to suit specific performance criteria. Our engineers use industry standard drainage software and hydraulic design calculations to ensure the system is correctly sized for any project requirement.

In order to complete this process and deliver the product options available, please provide the ACO with the following information:

- Proposed design flow – maximum allowable discharge (cfs, gpm, or l/sec)
- Proposed design head – invert of outlet pipe to top water level in the access shaft
- Proposed outlet pipe diameter
- Proposed type and size of outlet access shaft

Prior to production, **ALL** of the above information must be verified on ACO’s Product Confirmation Document issued at the time of order placement.

## FINISHED PRODUCT

From supplied information, ACO will size and design the Q-Brake Vortex to meet the design criteria and to suit the proposed application.

- ACO will supply:
- Head discharge table & graph
  - Q-Brake Vortex installation details
  - Information for access shaft

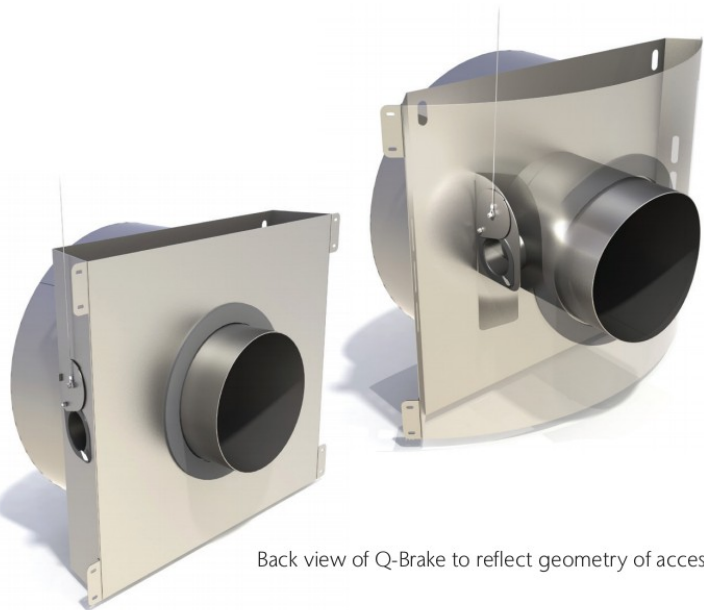
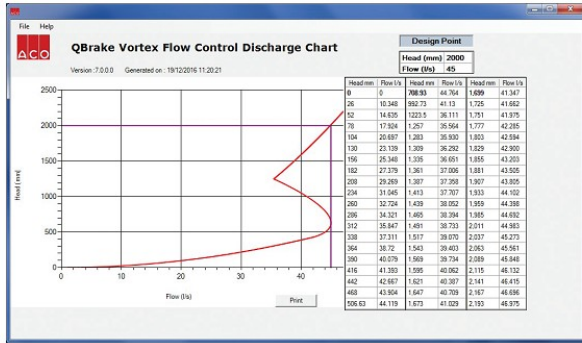

Back view of Q-Brake to reflect geometry of access shaft

# ACO Q-Plate

## What is ACO Q-Plate?

ACO Q-Plate orifice plates are designed for use where an ACO Q-Brake Vortex is not the most effective solution, or a conventional orifice plate is required. To suit application requirements, the range is available with or without remote bypass and drain down and is designed to match a variety of manhole configurations. A neoprene sealing gasket and fixing holes are featured on each unit.

The Q-Plate with emergency drain and bypass is recommended for all orifice apertures less than Ø4" (100 mm).

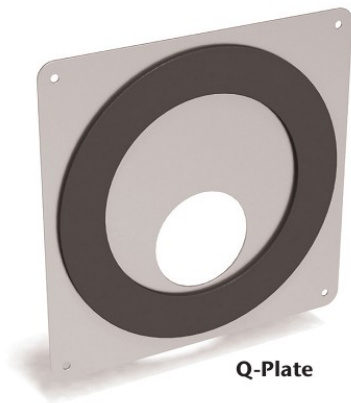

**Q-Plate**



**Q-Plate Bypass**

FEATURES	ACO Q-Plate	ACO Q-Plate Bypass
Flat or curved radius to suit manhole diameter	✓	✓
Manufactured from 304 stainless steel	✓	✓
Four fixing positions	✓	✓
Pipe sealing gasket	✓	✓
Bypass door (with seal) and latch		✓
Emergency drain-down and access cable		✓
Orifice aperture up to 6" (150 mm)		✓



## ACO Q-Plate Specification & Design Process

Two options of ACO Q-plate are available:

### ■ Q-Plate

4" (100 mm) orifice without remote drain-down and bypass

### ■ Q-Plate Bypass

4" (100 mm) orifice with remote drain-down and bypass (also available up to 6" [150 mm])

In order to process and deliver the appropriate product option, please provide ACO engineers with the following information:

- Proposed design flow – maximum allowable discharge (cfs, gpm, or l/sec)
- Proposed design head – invert of outlet pipe to top water level in the access shaft
- Proposed outlet pipe diameter
- Proposed type and size of outlet access shaft

Prior to production, **ALL** of the above information must be verified on ACO's Product Confirmation Document issued at the time of order placement.

### FINISHED PRODUCT

From supplied information ACO will size and design the ACO Q-Plate to meet the design criteria and to suit the proposed application.

ACO will supply:

- Head discharge table & graph
- Q-Plate installation details
- Information for access shaft sizing

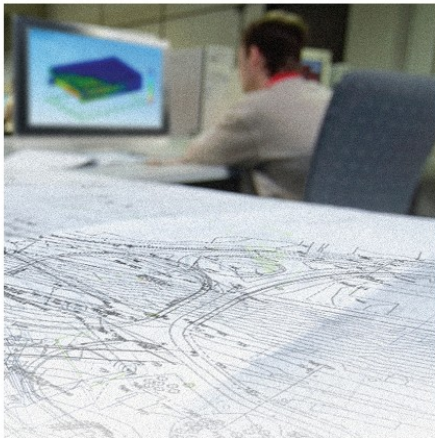

### ACO TECHNICAL SERVICES

ACO has embraced the concept of "value engineering" – an efficient approach to on-site construction that saves both time and money for contractor and client. ACO will advise on a design in an effort to minimize the total scheme and life cost of a proposal. By utilizing ACO's portfolio of products, it is often possible to remove the need for conventional underground drainage.

# 5

## Technical Services and Product Support

### ACO helps ensure the correct product by application and performance.

ACO has an established technical support team who offer guidance during all stages involving the use of ACO StormBrixx—from helping correctly size geocellular storage tanks, to on-site advice to ensure correct product installation.

ACO's technical service department will also offer advice and guidance on flow control options.

StormBrixx SD and HD can be modeled using the HydroCAD® Stormwater Modeling System. The HydroCAD system simplifies the calculation of the chamber's storage and infiltration behavior, creates automated system layouts, and assists with the process of designing your system to meet your specific storage needs within the required footprint. For more information, visit: <https://www.hydrocad.net/stormbrixx.htm>.













## 1. HYDRAULIC DESIGN

Hydraulic Design deals with temporary storage of water or water in storm events and its path, seeking to reduce the volume, speed, and frequency of surface water runoff. All these factors are site specific. Calculations are to be in accordance with local engineering standards/regulations.

If the required water storage volume and other relevant criteria are supplied to ACO's technical service department, an optimized tank layout can be configured using the proprietary optimizer software.



## 2. STRUCTURAL DESIGN

Structural design considers the load bearing capacity of the StormBrixx system to ensure it can safely carry loads it will be subjected to after site completion. Once the initial type of system required—infiltration or detention—is determined, the design parameters below should be considered:

- Soil type
- Vertical loads (including construction site traffic movement)
- Frequency of loads
- Horizontal loading
- Groundwater
- Depth of cover
- Surface pavement detail

Consideration must be given to maximum acceptable deflection of pavement above the StormBrixx tank. Although excessive deflections may not lead to catastrophic tank failure, they will cause frequent pavement deterioration in this area. ACO can assist with structural deflection values for specific live loads. Creep (long term deflection under pavement and soil dead loads) should also be investigated to ensure long life expectancy of the system.

ACO technical services can provide typical installation details to help with correct specification.

Structural calculations should be carried out by the project Engineer of Record. For complimentary advice, please contact ACO technical services.

**NOTE:** Extreme temperatures can affect properties of plastic. ACO recommends that at least part of, if not all, of the ACO StormBrixx structure is installed below the frostline.

### 3. DIMENSIONAL CONFIGURATION

To ensure correct location of tank in the ground, the variables shown in the drawing below have to be considered. ACO can supply typical installation details.

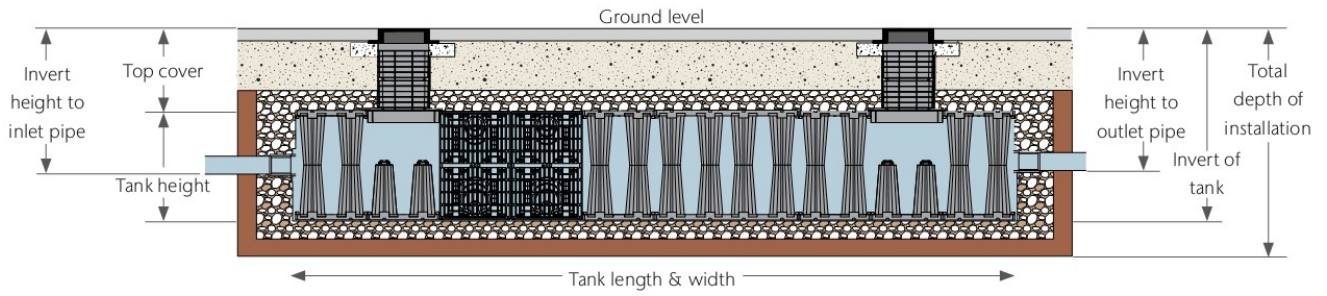



#### 4. MAINTENANCE

##### Operation

ACO StormBrixx has been designed to function in conjunction with the engineered drainage system on site. Operations will be driven by naturally occurring systems and will function autonomously. However, upholding a proper schedule of inspection and maintenance is critical to ensure continued functionality and optimum performance of the system.

##### Inspection

Both ACO StormBrixx and any other stormwater pre-treatment features incorporated must be inspected regularly. Inspection frequency must be determined based on the contributing drainage area, but should never exceed one year between inspections (six months during the first year of operation). Inspections may be required more frequently for pre-treatment systems. Refer to the manufacturer requirements for the proper inspection schedule. Inspection and measurements can be accomplished from the surface without physically entering any confined spaces. If inspection requires confined space entry, all local/regional requirements—as well as OSHA standards—must be followed.

StormBrixx may incorporate inspection ports, access/maintenance ports, and/or adjoining manholes. Each of these features are easily accessed by removing the cover at the surface. With the cover removed, a visual inspection can be performed to identify sediment deposits within the structure. All access points should be examined to complete a thorough inspection.





# ACO StormBrixx Installation

## Introduction

ACO StormBrixx modules are easily assembled with each tank module consisting of male and female connections that allow for brick-bonding locking the system together securely, with side panels inserted only around the outer perimeter of the system. This open design allows for easy access to clean. When properly designed, applied, installed, and maintained, StormBrixx systems are engineered to achieve a 50-60 year design life.

ACO StormBrixx system can be utilized for detention, retention, infiltration, reuse, and specialty applications across a wide range of industries including commercial, residential, and landscape applications. The product's modular design allows the system to be configured in almost any shape (even around utilities) and to be located under any pervious or impervious surface.

ACO offers two different StormBrixx module heights (SD & HD) that can be stacked uniformly up to three layers high for SD and four layers high for HD. This allows for numerous height configurations up to 9' (2.74 m) tall. Modules can be buried up to a maximum invert of 14' (4.26 m) for SD and 19.7' (6 m) for HD and require a minimum cover of 24" (610 mm) for load rating. When selecting the proper module type, it is important to consider the minimum required cover, any groundwater or limiting zone restrictions, footprint requirements, and all local, state, and federal regulations. Please consult the design engineer if unclear on any of the above.





## Excavate Site

The foundation (subgrade) of the subsurface storage structure is an extremely important part of the module system installation, as this is the location where the system applies the load generated at the surface. If the subgrade lacks adequate support or encounters potential settlement, the entire system could be adversely effected. When installing an underground storage solution, it is imperative that a geotechnical investigation be performed to ensure a strong foundation.

### BEARING CAPACITY

The bearing capacity is the ability of the soil to resist settlement; i.e. it is the amount of weight the soil can support. This is important versus the native condition because the system is replacing earth. Although the system weighs less than the earth, the additional load displacement of the earth is not offset by the difference in weight.

### LIMITING ZONES

Limiting zones are conditions in the underlying soils that can affect the maximum available depth for installation and can reduce the strength and stability of the underlying subgrade. The 2 main forms of limiting zones are water tables and bedrock.

### COMPACTION

Soil compaction occurs as the soil particles are pressed together and pore space is eliminated. By compacting the soils to 95% Proctor Density (recommended by ACO), the subgrade strength will increase, in turn limiting both the potential for the soil to move once installed and for differential settlement to occur throughout the system. If designing the specific compaction requirement, settlement should be limited to less than 1" (25 mm) through the entire subgrade and should not exceed a 1/2" (13 mm) of differential settlement between any two adjacent units within the system over time.

### MITIGATION

If a minimum subgrade bearing capacity cannot be achieved because of weak soil, a suitable design will need to be completed by a Geotechnical Engineer. This design may include the over excavation of the subgrade and the use of an engineered fill or slurry. Additional material such as geogrid or other products may also be required. Please contact a Geotechnical Engineer prior to selecting products or designing the subgrade.

### EXCAVATION

Stake out and excavate to elevations per approved plans. Excavate the designated surveyed area following all relevant local, state, federal and OSHA guidelines.

Recommended excavations should include: - minimum 12" (305 mm) perimeter around ACO StormBrixx to allow for adequate compaction of backfill - Enough depth to accommodate a minimum 6" (152 mm) base (if required) and 24" 610 mm) for the top cover.

### EXCAVATION REQUIREMENTS

- a. Subgrade excavation must be a minimum of 6" (152 mm) below designed StormBrixx invert.
- b. The excavation should extend a minimum of 12" (305 mm) beyond the StormBrixx dimensions in each length and width to allow for adequate placement of side backfill material.
- c. Remove objectionable material encountered within the excavation, including protruding material from the walls.
- d. Furnish, install, monitor and maintain excavation support (e.g., shoring, bracing, trench boxes, etc.) as required by Federal, State and local laws, ordinances, regulations, and safety requirements.

## Lay Sub Base

Level the bottom of the excavation as shown on plans. Base of excavation must be uniform, level and free of debris and soft or yielding subgrade areas. Compact to at least 95% standard proctor density (or as required by engineer) unless infiltration of stormwater into subgrade is desired.

- Subgrade shall be unfrozen, level (plus or minus 1%), and free of lumps or debris with no standing water, mud or muck. Do not use materials or mix with materials that are frozen and/or coated with ice or frost.
- Unstable, unsuitable and/or compromised areas should be brought to the engineer's attention and mitigating efforts determined prior to compacting the subgrade.
- Subgrade must be compacted to 95% standard Proctor density or as approved by the Engineer of Record. If code requirements restrict subgrade compaction, it is the requirement of the geotechnical Engineer to verify that the bearing capacity and settlement criteria for support of the system are met.

The sub grade is constructed of 6" (152 mm) angular stone, sand, 1/4 minus gravel, or pea gravel. The bed has not been designed as a structural element but is utilized to provide a level surface for the installation of the system and provide an even distribution of load to the subgrade.

**NOTE:** The Engineer of Record shall be responsible for minimum soil bearing capacity required based on load rating and top cover depth. Minimum soil bearing capacity is required so that settlements are less than 1" (25 mm) through the entire subgrade and do not exceed long-term 1/2" (13 mm) differential settlement between any two adjacent units within the system. Subgrade must be designed to ensure soil bearing capacity is maintained throughout all soil saturation levels.

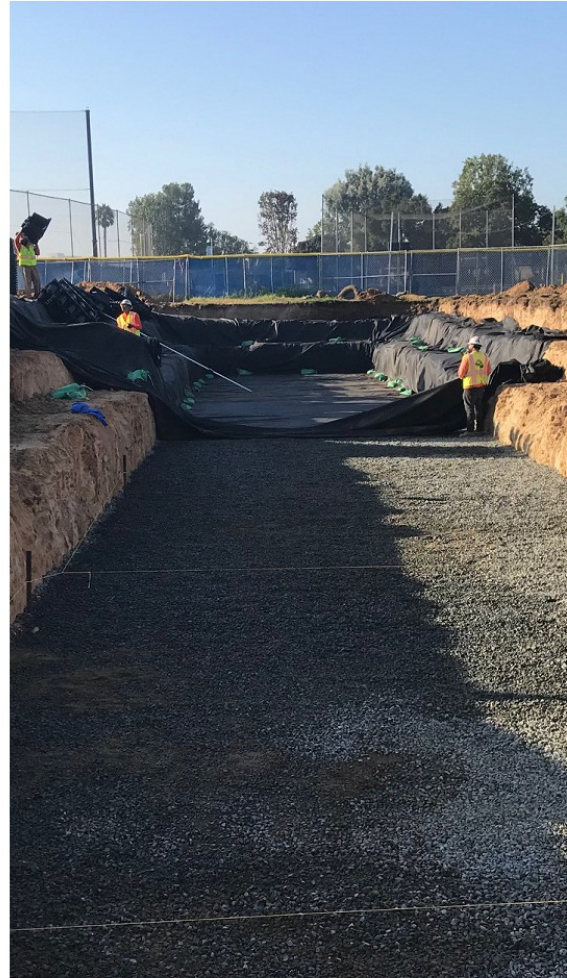



## Lay Liner/Geotextile

### A: IMPERMEABLE LAYER

In designs that prevent runoff from infiltrating into the surrounding soil (detention or reuse applications) or groundwater from entering the system, an impermeable liner is required. When incorporating a liner as part of the system, ACO recommends the use of a manufactured product such as a PVC liner, which is wrapped around the geocellular tank prior to backfill.

### B: PERMEABLE LAYER

1. Install specified geotextile fabric and/or liner material in panels of the proper length, and place them over the sub grade, covering the floor of the excavation. The geotextile fabric and/or liner should extend at least 24" (610 mm) beyond the edge of the StormBrixx system. Adjacent panels of material should be overlapped by a minimum of 12" (305 mm) or more in sealed system joints (may require heat-welding).
2. Use pins, staples, sandbags to hold the geotextile in place, preventing it from blowing or sliding out of position.
3. Patch any holes made in the Geotextile by placing a small patch of fabric over the damaged area. The patch must be large enough to cover the damaged area with at least 12" (305 mm) of overlap on undamaged material.
4. If a liner and/or additional geotextile is required per plans, install these as shown on the project plans.
5. Correct any unsatisfactory conditions.

**NOTE:** ACO does not provide membrane liners or geotextile fabrics with StormBrixx systems. This should be purchased separately. Please consult with membrane liner manufacturer and install in accordance with liner manufacturers recommendations.



## Assemble ACO StormBrixx Tanks

### THE MODULAR SYSTEM

ACO StormBrixx is a geocellular tank that is designed to fit together easily to form a strong, long-lasting connection.

### EASE OF INSTALLATION

Installation is easy with a snap-lock system consisting of male and female connectors that audibly lock into place during assembly, two half modules will connect to create a full height module. Half modules snap and lock into one another vertically by placing one atop another and by using the male and female connections, layers and adjacent modules can be attached.

### COLUMN CONNECTIONS

See pages 13–14 for instructions regarding layout options for StormBrixx.

### TYPES OF CONFIGURATIONS

- Brick-bonding: Brick-bonding or cross-bonding can be applied to StormBrixx to provide structural strength and is a key feature of the product. The brick-bonding method is like assembling Lego®s to create a single solid structure comprised of individual modules that are interlocked together. Repeat for subsequent layers using connectors to bond layers to one another.
- Irregular Shapes: StormBrixx systems can be easily configured to site specific requirements. Irregular shapes are not a problem as the tank can be constructed to avoid tree pits, buildings and other ground constraints, while offering countless configurations to meet requirements.





## ASSEMBLE TANKS

1. **Determine the starting location:** ACO recommends to use an inlet or outlet pipe as a guide. Using a string line, establish two adjacent edges of the ACO StormBrixx footprint and ensure that the corner is square. Mark these two edges with marking paint and remove string line.
2. **Begin placing the modules:** Place modules in the corner of the marked area using the preferred configuration pattern.
3. **Do NOT place units on their sides:** This will void the warranty, check plans to ensure the correct orientation of the system. StormBrixx units should fit together evenly, variations in the height of the layers (< ½”) are acceptable, but reasonable efforts should be made to minimize these. If gaps or height variations persist through 3 or more adjacent units, remove modules and pull back the textile to repair and flatten base.
4. **Sediment Forebay:** An essential step of designing, installing, and maintaining a subsurface system is preventing silt, sediment and debris from entering the system. A sediment forebay can be designed into an StormBrixx HD (not SD) geocellular tank to capture the water quality flow or “first flush” as defined by a regulatory or permitting agency, this can be done by incorporating sediment rows (or bays) at the inlets of the system to prevent debris from entering the rest of the system (see below). The sediment forebay is built into the system utilizing side panels to isolate a section of the tank, which is then wrapped with geotextile fabric to isolate this from the rest of the StormBrixx system. This allows for the full system capacity to be utilized while storing any sediment, silt, or debris in one easy-to-remove location with the fabric-wrapped modules providing filtration and promoting the settling of pollutants.
5. **Ventilation of System:** Subsurface systems require ventilation to prevent pressurized build-up when the system is operating at full capacity which in turn can cause the system to surcharge or even fail. StormBrixx offers easy connection of ventilation pipes directly to the module to evenly relieve system pressure.
  - a. The openings for ventilation must be cut out the top of the StormBrixx modules before they are installed.
  - b. A sawzall with an extra-long saw blade is required to cut out the openings for the pipe penetrations in the side panels and the top of the StormBrixx module for ventilation.
  - c. The pipe adapter is mounted in the previously cut opening on the top of the module allowing the installer to connect the desired pipe size needed for ventilation as per engineers specification.
  - d. The geotextile is cut and is pushed over the pipe adapter to encapsulate StormBrixx.

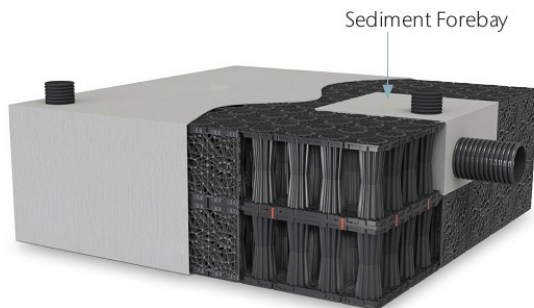

## Install Layer Connectors

### A: SINGLE LAYER SYSTEM

If only one layer of ACO StormBrixx is installed, no connectors are required. Laying StormBrixx in the brick-bonding pattern provides additional stability for the overall system. If the units are fully brick-bonded, the structure will not need connectors to hold the system together.

### B: MULTIPLE LAYER SYSTEM

Layer connectors are used if two or more layers of StormBrixx are installed. Two individual connectors snap together and are inserted between the individual layers as positional fixing. This helps prevent lateral movement between layers. These two connectors should protrude from the top of the structure by approximately 1" (25 mm), depending on which module version is used. These protruding layer connectors fit the base of the second layer and are key to minimizing lateral movement during backfill and overall installation.

StormBrixx SD: To align two layers, a double connector is used at the edge of the module (page 34).

StormBrixx HD: A centrally positioned double connector per module connects two layers (page 48).





## Build Access & Inspection Points

### A: ENTRANCE VIA REMOTE ACCESS PLATE

To obtain access to the ACO StormBrixx SD or HD unit the remote access plate can be used. This plate is located within the overall system. Modules are removed to create free movement for inspection and cleaning of the system. With the access plate, an easy installation is possible at any desired position apart from the perimeter edge of the tank.

**NOTE:** Ensure the access plate is NOT used on the edge of the structure. This unit must be used at least one unit inside the StormBrixx structure.

### B: ENTRANCE VIA THE ACCESS UNIT

Access can be gained to the ACO StormBrixx system by using the access unit. These units can be installed both within the structure and on the outer edges. They replace a half-length StormBrixx module within the layers. With multi-layer systems, the units stack on top of each other and integrate with the StormBrixx modules.

Each access chamber has markings that will indicate the different size openings can be cut out to accommodate various pipe sizes 4" to 18" (100 mm to 450 mm). To create an opening within the access chamber, drill a hole to insert a saw blade and cut along the template provided. Access chambers are extended to the surface using the ACO access chamber access chamber units or by using 18" (450 mm) twin wall pipe cut to suitable length. Access covers are placed at the pavement surface. In the event that a larger access chamber is required due to large pipe inlets/outlets/etc., ACO recommends a square, 4' x 4' concrete access, which replaces a section of the StormBrixx tank. Contact ACO for details.

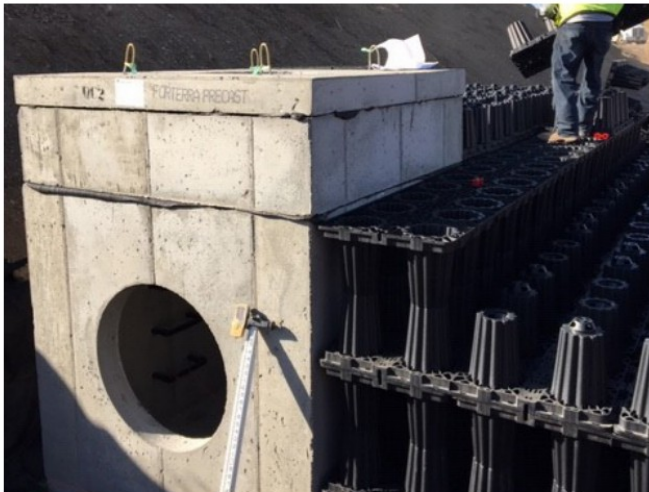

## Place Pipe Connections

The ACO StormBrixx system offers pipe adapters that are used for the connection of inlet and outlet pipes as well as ventilation pipes. These are typically located within the side panels of the StormBrixx. Pipe connector sizes range from 4" (100 mm) to 15" (450 mm) markings on the side panels will indicate the different size openings. The openings for inlets and outlets must be cut out before installing the side panels, a sawzall with an extra-long saw blade. The pipe adapter is mounted in opening made in the side panel and fixed securely. The geotextile is cut and pushed over the pipe and sealed.

## Wrap System in Membrane Liner or Geotextile Fabric

Upon completion of ACO StormBrixx assembly, wrap modules in geotextile fabric and/or membrane liner.

- Geotextile fabric shall be wrapped and secured per the manufacturer's recommendations.
- Seal any access ports/pipe connections per the manufacturer's requirements.

**NOTE:** If damage occurs to the geotextile fabric or impermeable membrane liner, repair material in accordance with the geotextile/liner manufacturer's recommendations.

1. Cut panels of geotextile to fit over the top and down both sides of the StormBrixx with approximately 24" (610 mm) of excess material on each side of the system. This 24" (610 mm) material should overlay the geotextile placed below StormBrixx tank, creating a clean overlap to seal the system.
2. Use duct tape, sand bags or other ballast to temporarily secure overlaps.
3. Where the geotextile intersects an Inspection or Maintenance Port, cut an "X" into the geotextile and pull it over the pipe. The flaps of the "X" should point AWAY from the StormBrixx tank. Cut excess fabric away and seal geotextile to the pipe using blackjacking or polyurethane sealant.
4. Fold geotextile for outside corners and lay excess material flat against the StormBrixx tank. Leave corners loose to avoid creating weak spots in the material and temporarily secure excess fabric with duct tape.
5. Where the inlet and outlet pipes connect to the StormBrixx tank cut an "X" into the geotextile so that the pipe makes DIRECT contact with the StormBrixx modules, pull the flaps of the "X" over the pipe so that the flaps of the "X" point AWAY from the system. Cut excess fabric away and seal geotextile to the pipe using blackjacking or polyurethane sealant.
6. Walk bottom edge of geotextile along the sides of StormBrixx tank to eliminate gaps between the fabric and the bottom corner of the system.
7. Seal the liner using tape or heat welding and ensure the StormBrixx system is fully sealed with no rips, tears or punctures.





## Backfill Site

### BACKFILL SIDES

The backfill is designed to limit the strain on the product through load dispersion and ensure the product's longevity. A minimum of 12"-wide (305 mm) angular stone or well-graded granular soil/aggregate, typically road base or earthen fill (maximum 1"-3" [25–80 mm] particle size) must be placed around all sides of the system. In addition, a minimum layer of 24" (610 mm) angular stone, sand or good quality of native backfill is required on top of the system. All material is to be placed evenly in 12" (305 mm) lifts around and on top of the system and aligned with a vibratory plate compactor.

1. Once the geomembrane is secured, begin to place the side backfill.
2. Place backfill material around perimeter of the ACO StormBrixx tank distributing the material evenly to prevent movement of the StormBrixx modules. All backfill material must meet requirements listed in the specifications.
3. Place material utilizing an excavator, dozer or conveyor boom.
4. Use a trench roller or plate compactor to compact backfill in 12" (305 mm) lifts to provide uniform distribution.
5. Continue placing and compacting backfill in 12" (305 mm) lifts until the material reaches the top of the StormBrixx units.

**NOTE:** While some backfill materials will yield a 95% proctor density without compaction, vibratory compaction of the material must be completed to ensure the stability of the system. Skipping this step will void the manufacturer's warranty.

- Do not apply vehicular load to the StormBrixx tank modules during placement of side backfill. All material placement should occur with equipment located on the native soil surrounding the system.
- If damage occurs to the geotextile fabric or impermeable liner, repair the material in accordance with the geotextile/liner manufacturer's recommendations.



## BACKFILL TOP

Use an excavator, dozer, or conveyor boom to dump backfill material adjacent to StormBrixx tank, then push material over the system. Use a walk-behind plate vibrator to settle the backfill and provide an even distribution in maximum 12" (305 mm) lifts. Backfill must meet requirements listed in specifications, suitable materials are as follows: well-graded granular soil/aggregate, typically road base or earthen fill (maximum 1"-3" [25–80 mm] particle size) crushed angular stone placed between modules and road base or earthen fill.

### Landscaped Area

1. Place fill onto the geotextile. Maximum 12" (305 mm) lifts, compacted with a vibratory plate or walk behind roller to a minimum of 90% standard Proctor density.
2. The minimum top cover to finished grade should not be less than 12" (305 mm) and the maximum depth from final grade to the bottom of the lowest module should not exceed 14' (4.27 m) for StormBrixx SD installations and 21' (6.40 m) for HD installations.
3. Compact top backfill to 95% standard Proctor density (or as shown on plans) using your walk-behind trench roller. Alternately, a roller (maximum gross vehicle weight of 6 tons) may be used. Roller must remain in static mode until a minimum of 24" (610 mm) of cover has been placed over the modules
4. Finish to surface and complete with vegetative cover.

### Impervious & Pervious Areas

1. Place fill onto the geotextile. Maximum 12" (305 mm) lifts compacted with a vibratory plate or walk behind roller to a minimum 95% standard Proctor density or to meet the Engineer of Record's specification.
2. Subbase materials should be referenced by the approved engineering drawings.
3. The minimum top cover to finished grade should not be less than 24" (610 mm) and the maximum depth from final grade to the bottom of the lowest module should not exceed 14' (4.27 m) for ACO StormBrixx SD installations and 21' (6.40 m) for HD installations.
4. Compact top backfill to 95% standard Proctor density (or as shown on plans) using your walk-behind trench roller. Alternately, a roller (maximum gross vehicle weight of 6 tons) may be used. Roller must remain in static mode until a minimum of 24" (610 mm) of cover has been placed over the modules.
5. Finish to the surface and complete with asphalt, concrete, pavement, etc.

#### NOTE:

- A vibratory roller may only be utilized after a minimum 24" (610 mm) of compacted material has been installed or for the installation of the asphalt wearing course.
- If damage occurs to the geotextile fabric, repair the material in accordance with the geotextile manufacturer's recommendations.

MATERIAL PLACEMENT	MATERIAL TYPE/DESCRIPTION
Finished surface	Topsoil, hardscape, stone, concrete or asphalt per Engineer of Record
Compactable fill	Granular well graded soil/aggregate, typically road base or earthen fill, crushed angular stone, maximum 1"-3" (25–80 mm) particle size.
Top backfill	Granular well graded soil/aggregate, typically road base or earthen fill, crushed angular stone, maximum 1"-3" (25–80 mm) particle size.
Side backfill	Granular well graded soil/aggregate, typically road base or earthen fill, crushed angular stone, maximum 1"-3" (25–80 mm) particle size.
Subbase	Granular well graded soil/aggregate, earthen fill, with ability to compact to 95% standard Proctor density



## Site Traffic Considerations

Construction loads are often the heaviest loads the system will experience. Care must be taken during backfilling and compaction, and post-installation construction traffic should be routed around the system if possible.

**NOTE:**

- A minimum of 12" (305 mm) of material must be maintained between the dozer tracks and top of the StormBrixx system. For best results, ACO recommends pushing at least 14" (360 mm) of backfill over modules, so a 12" (305 mm) minimum lift is maintained as the material compacts beneath the dozer. It is recommended that the dozer drive straight on and back straight off of the system during backfill placement. Turning movements are likely to dislodge backfill material, reducing the thickness of the lift and potentially damaging the StormBrixx system. Once there is a minimum of 12" (305 mm) or more of cover, use either a small roller (not vibrating) or up to a 24,000 lbs excavator or track dozer to traverse the top of the StormBrixx system.. These should not change direction when on top of the StormBrixx system, as this will create excess dynamic loads.
- Some materials will compact significantly while others may dislodge excessively during construction. Never allow lift thickness to compact to less than 12" (305 mm) without adding more material ensuring 12" (305 mm) lifts at all times.
- Dump trucks should not drive over or dump material on top of the StormBrixx system.

**TYPICAL PLANT EQUIPMENT WEIGHTS (LBS)**

<b>John Deere 550J LGP</b>	18,252
<b>Caterpillar DSK LGP</b>	21,347
<b>New Holland D95 LGP</b>	20,700
<b>Case 850K LGP</b>	20,700
<b>Komatsu D39PX-21</b>	19,620

## Secure the Installation

Some construction vehicles exceed the AASHTO HS-20 standard most detention systems are designed to meet. To prevent damage from these vehicles, the installation should be secured to prevent unauthorized traffic from driving over the system once it has been installed. Projects nearing completion should use warning tape or temporary fencing to secure the installation. Regardless of what method is selected to secure the installation, it must remain in place until construction activity has concluded and no further access of heavy vehicles exceeding the HS-20 standard is necessary.

## Pretreatment

Removing pollutants from stormwater runoff is an important component of any stormwater management plan. Pretreatment prevents water quality deterioration, increases longevity, and helps maintain system performance over time. Treatment products vary in complexity, design, and effectiveness, and therefore, should be selected based on specific project requirements.



# ACO Q-Brake Vortex Installation Guide

## Chamber Construction

Construct access chamber for flow control unit. If chamber is cylindrical, diameter of chamber should be specified on the Order and Product Confirmation Document for flow control unit.

Base of chamber must be at a level 8" (200 mm) below bottom of flow control unit. When there is a chamber with a pre-benched base, there must be an 8" (200 mm) deep sump below bottom of unit as shown to right.

## Mark Placement of the ACO Q-Brake Vortex

Bring flow control unit up to outlet pipe using lifting eyes where appropriate. Ensure unit is upright (arrow pointing up). Mark position of fixing holes on chamber wall. Remove unit and drill fixing holes to suit 3/8" bolts supplied with unit. (Note: bolts are stainless steel 3/8" anchor bolts requiring a 5/8" [15 mm] hole).

## Secure ACO Q-Brake Vortex

Place bolts into drilled holes. Secure flow control unit onto bolts (check that it is upright). Ensure that the gasket is flat against wall. Fit nuts, tighten them to pull unit against gasket, and seal it against wall.

## Secure Remote Access Cable

Fix the two wire guide rings (supplied) to chamber wall, one approximately mid-height and one just under access cover. Thread remote access cable through rings. Adjust length of wire by fixing handle in correct position and cut to length if necessary.

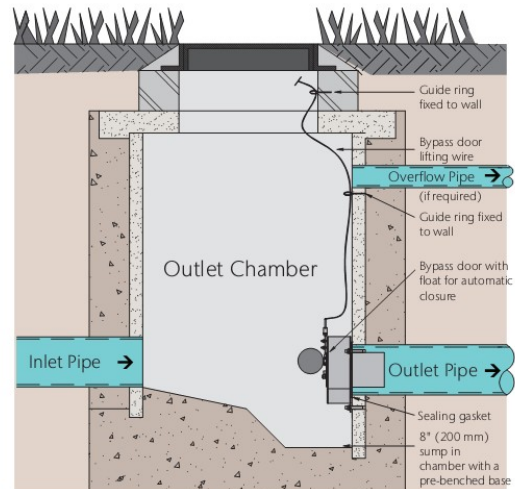

### Fixing installation detail for round manhole chambers

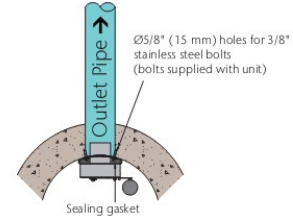

### Fixing installation detail for flat-sided manhole chambers

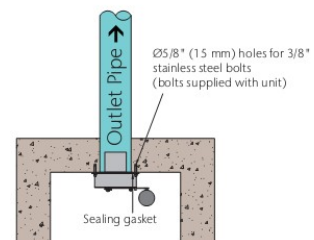



# ACO Q-Plate Installation Guide

## Chamber Construction

Construct access chamber that is to house ACO Q-Plate orifice control. Note that if chamber is cylindrical, diameter of chamber should be specified on the Order and Product Confirmation Document for ACO Q-Plate Orifice control unit.

There should be a small sump under the outlet to ensure orifice control cannot be easily blocked; ideally there should be upstream sediment and debris traps. When there is a chamber with a pre-benched base, there should be a minimum 8" (200 mm) deep sump below bottom of unit as shown to right.

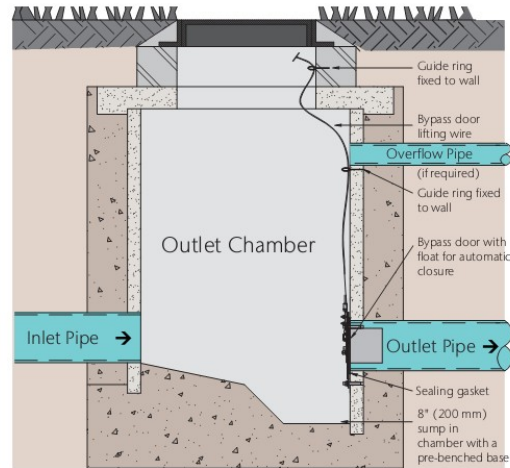

## Mark Placement of the ACO Q-Plate

Offer ACO Q-Plate orifice control unit up to outlet pipe. Ensure unit is upright (arrow pointing vertically up) and that orifice is correctly positioned at invert of outlet pipe.

Ensure a good seal between orifice plate and outlet pipe. Mark position of fixing holes on chamber wall. Remove unit and drill fixing holes to suit bolts supplied with unit.

### Fixing installation detail for round manhole chambers

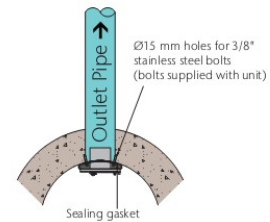

## Secure ACO Q-Plate

Place bolts into drilled holes. Secure ACO Q-Plate orifice control onto bolts (check that it is correctly aligned). Ensure that gasket is flat against wall. Fit nuts, tighten them to pull unit against gasket, and seal it against wall.

### Fixing installation detail for flat-sided manhole chambers

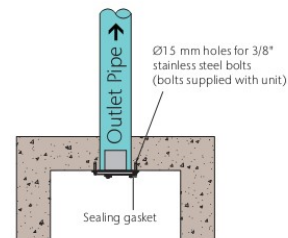

## Secure Remote Access Cable

If ACO Q-Plate has been supplied with a drain down and bypass door, fix two wire guide rings (supplied) to chamber wall, one approx mid-height and one just under access cover. Thread bypass door lifting wire through rings. Adjust length of wire by fixing handle in correct position and cut to length if necessary.

# ACO StormBrixx Inspection & Maintenance

## Maintenance Procedures

It is important to note that failure to control and remove sediment build-up in a sustainable drainage system is the single largest cause of system failure. To ensure effective management of silt in an ACO StormBrixx infiltration system, a sediment forebay can be incorporated. Pretreatment prior to the geocellular tank is recommended.

As sediment has the potential to carry high levels of pollutants, it is important that any sediment removed from the system is disposed of by a licensed contractor in accordance with local regulations.







#### **INFILTRATION SYSTEMS**

In order to periodically check the effectiveness of the ACO StormBrixx infiltration system, a percolation test can be carried out on the system and compared with the original data. If there is a significant decrease in the infiltration rates, the infiltration system should be filled via the inspection chamber to the invert level of the inlet pipe. It should then be flushed through with water in order to remove sediment and unbind the geotextile.

#### **DETENTION SYSTEMS**

Block the outflow control device—but not the overflow pipe—before filling the detention system to the invert level of the vent pipe. The system should then be filled, then flushed, and the water effluent removed and disposed of by a pumped tanker.

The frequency of the maintenance procedure for ACO StormBrixx systems will be determined by the inspection team. ACO recommends inspections be carried out at least twice a year, and during the first year after significant storm events. In order to minimize silt build-up, ACO also recommends the use of pretreatment systems upstream of the detention device.

# Flow Control Operation & Maintenance

## Commissioning the Product

Before the product is commissioned, the chamber containing the ACO Q-Brake Vortex should be inspected in line with normal practice. Any debris or silt should be removed. Any visible fixing bolts should be checked.

If an internal blockage is suspected, the control can be inspected internally and cleaned out by opening the inspection bypass door on the upstream end. The bypass door must be returned to the closed position before the control becomes operational or bolted shut.

## Frequency of Inspection/ Maintenance

Inspections should be carried out at frequent and regular intervals (approximately every 3-6 months). The frequency will depend upon the location and the environment, and should be based on local knowledge. Action is only required in the event of a blockage or suspected blockage.

## Maintenance Plan

ACO Q-Brake Vortex flow controls require no routine maintenance although inspections should be carried out at regular intervals (See prior section regarding frequency of inspection/maintenance).

## Manual Handling

ACO Q-Brake Vortex flow controls should be handled in accordance with applicable OSHA regulations.

## Service Life

ACO Q-Brake Vortex flow controls have no moving parts to wear or fail. Manufactured from grade 304 stainless steel plate they will resist scour, degradation and chemical attack. The unit is designed to outlast the drainage system in which it is installed.

## Model Specification Clause

The vortex flow control device shall be supplied by ACO, Inc.; all materials and components within the scope of this system shall be obtained from this manufacturer.

All units shall be manufactured from grade 304 stainless steel incorporating rear mounted remote access bypass and emergency drain down door complete with stainless steel cable and fixings.

ACO Q-Brake Vortex is a vortex flow control device designed to suit a design head of # inch and design flow of # gpm.

# Insert information as appropriate

### 3 Part Master Format Specification

ACO Q-Brake Vortex should be specified via the 3 part master format system outlined by CSI. The 3 part specification general product information. Documentation is available at [www.acostormbrixx.us](http://www.acostormbrixx.us).





**MOUNTAIN AMERICA  
CREDIT UNION**

Glendale, AZ  
United States

ACO StormBrixx HD replaced a CMP design in a tight, traffic-loaded space with existing infrastructure. When additional storage was needed for the site, the original CMP design required 25% larger footprint that would then extend into major utility lines. With ACO StormBrixx HD's 95% storage efficiency, the entire 9,068 ft<sup>3</sup> (256.78 m<sup>3</sup>) system fit into less space than the original CMP footprint, saving the client \$40,000 that would have been required to move the large utilities.

**PORTFOLIO**



# askACO

Every project brings its own requirements and challenges. In addition to our products, ACO offers you our knowledge and services to jointly develop tailor-made solutions from planning to after-sales support. With our extensive network of sales and support representation, ACO strives to ensure that the needs of your project are professionally and efficiently met.



train

## Information and further education

At ACO, we share the expertise of the global ACO Group with architects, engineers, installers, and distributors who value quality. We invite you to benefit from it.



design

## Planning and optimization

There are many drainage solutions to consider when planning a project. But which option leads to the most economically and technically safest solution? We help you to find the right answer.







support

### **Construction advice and presence**

To prevent unpleasant surprises between planning and implementation stages, we advise and support you on a project-specific basis.



care

### **Inspection and maintenance**

ACO products are designed and produced to last. With our after-sales support, we ensure that ACO will exceed your standards for years to come.

### **ACO on the web**

You will find further information for our products on the ACO USA website. This allows you to access technical data, images, specifications, and installation instructions during planning.

**[www.acousa.com](http://www.acousa.com)**  
**[www.acostormbrixx.us](http://www.acostormbrixx.us)**

**[www.askACO.us](http://www.askACO.us)**

ACO products support the ACO System Chain



---

## Surface Water Management

- ACO Drain - Commercial Trench Drains
- ACO Infrastructure - Heavy Duty Drainage
- ACO Sport - Athletic Venue Drainage
- ACO StormBrixx - Geocellular Tanks
- ACO Aquaduct - Custom Drainage
- ACO Environment - Solid & Oil Separators
- ACO Wildlife - Guidance & Passage
- ACO Self - Garden & Landscape Drainage
- ACO UtilityDuct - Ducting System

## Building Drainage

- ACO Stainless - Stainless Trench Drains
- ACO BoxDrain - Stainless Hygienic Drains
- ACO FloorDrain - Stainless Point Drains
- ACO Pipe - Stainless Push-fit Piping
- ACO ShowerDrain - Bathroom Drainage

---

### ACO, Inc.

West Sales Office  
825 W. Beechcraft Street  
Casa Grande, AZ 85122  
Tel: (520) 421-9988  
Toll-Free: (888) 490-9552  
Fax: (520) 421-9899

Northeast Sales Office  
9470 Pinecone Drive  
Mentor, OH 44060  
Tel: (440) 639-7230  
Toll-Free: (800) 543-4764  
Fax: (440) 639-7235

Southeast Sales Office  
4211 Pleasant Road  
Fort Mill, SC 29708  
Toll-Free: (800) 543-4764  
Fax: (803) 802-1063

info@acousa.com  
[www.acousa.com](http://www.acousa.com)

© December 2019 ACO, Inc.

All reasonable care has been taken in compiling the information in this document. All recommendations and suggestions on the use of ACO products are made without guarantee since the conditions of use are beyond the control of the company. It is the customer's responsibility to ensure that each product is fit for its intended purpose and that the actual conditions of use are suitable. ACO, Inc. reserves the right to change products and specifications without notice.

Print #SB100

ACO. creating  
the future of drainage

