

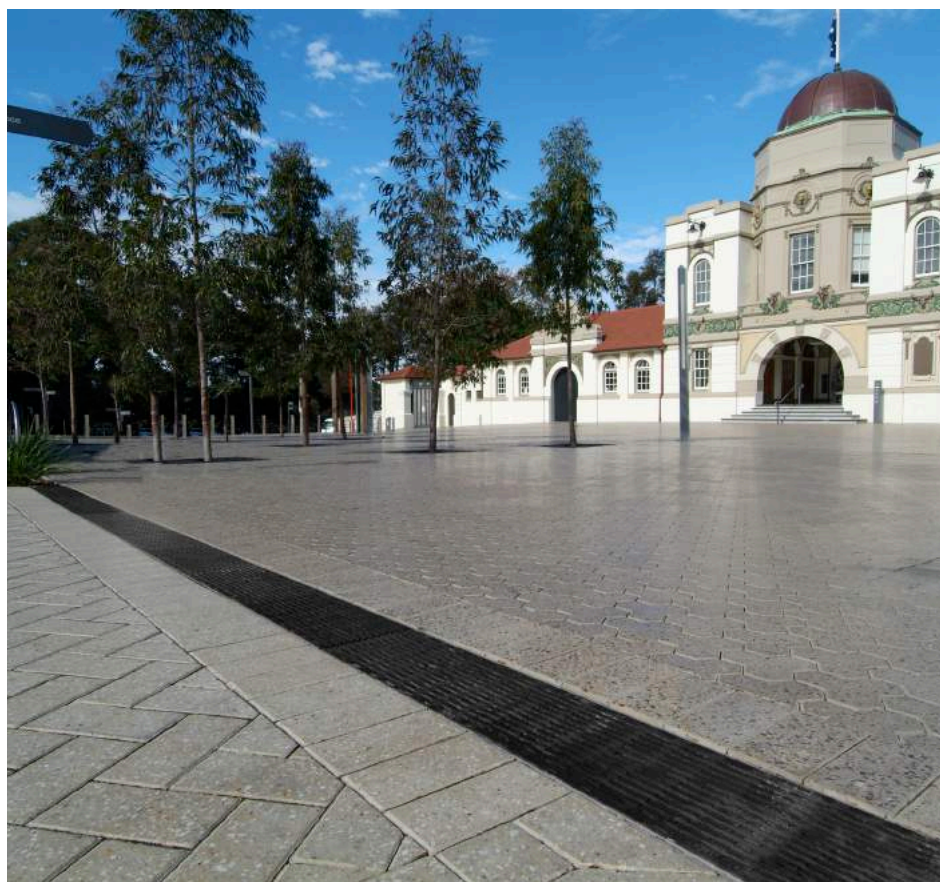

KlassikDrain

General Purpose Trench Drains

KlassikDrain is the market's most widely used modular trench drain system. Developed to offer edge protection to the channels and provide a discreet look that highlights the grate style only. KlassikDrain offers a wide range of grates in many styles, materials, finishes and load categories to provide the ultimate plug and play trench drain system.



Features & Benefits



Wide Choice of Grates

In various materials and styles (including ADA compliant) for applications from Load Class A to Load Class E. See page 13.



DrainLok & QuickLok®

Patented, boltless locking systems provide quick fitting and removal of grates. Helps reduce installation/maintenance time and cost.

Integral Steel Edge Rail

Provides additional strength and protects channel body from damage. Stainless steel edge rail also available.

Polymer Concrete

A durable, yet lightweight material made from polyester (a resin binder) reinforced by mineral aggregates and fillers. It provides up to four times the compressive strength of cement concrete. See page 170 for material properties.



Interconnecting End Profiles

Allow easy and effective joining of channels. Appropriate sealant can be used to create a sealed joint.

K300 12" INTERNAL WIDTH



Knockouts

Included on every 5th channel to allow vertical evacuation of the system along the run. See product pages for sizes for each system.

K200 8" INTERNAL WIDTH

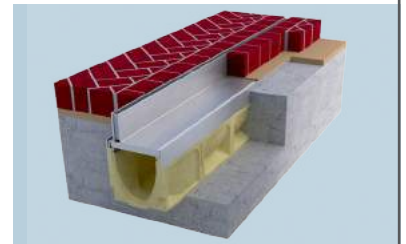

Brickslot 100 & 200

A discreet drainage solution for use with brick or stone pavers. Available as standard, Heel-resistant and Twinslot versions. See pages 39 and 57.



Anti-Shunt Lugs

Protrusions in grate fit into recesses on the edge rail to prevent longitudinal movement.

Profiled Side Walls

Strengthening pillars and frost keys provide channel body strength and mechanical keying to surrounding concrete.



Channel Identification

Channels feature numbering on sidewalls and base of channel (to allow easy identification after concrete encasement).

Shipping Gipple/Groove

Side interlocking feature ensures safer stacking of channels on pallets for shipping and minimizes breakage.

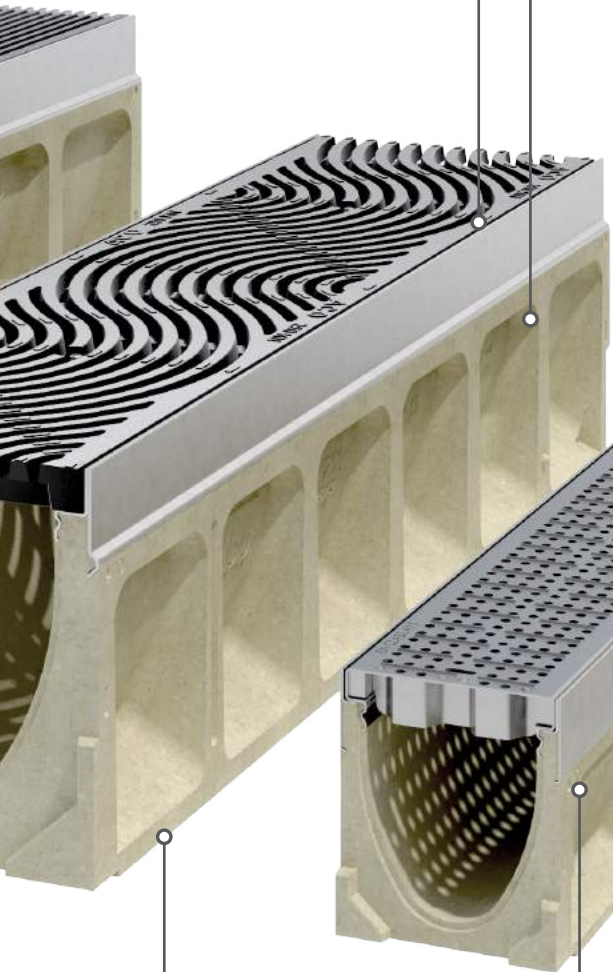

K100 4" INTERNAL WIDTH

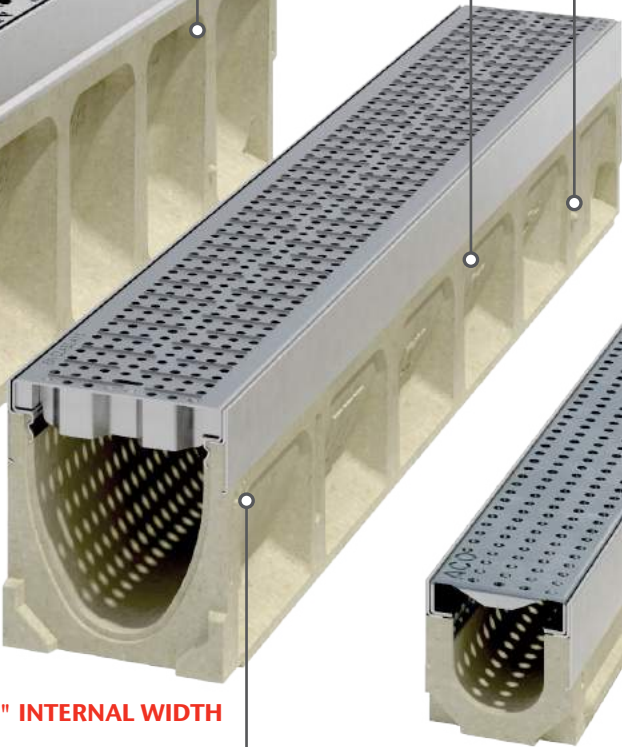

K50 2" INTERNAL WIDTH

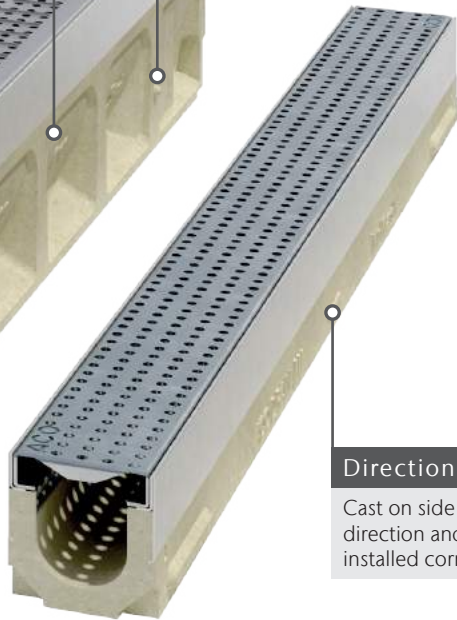

Directional Arrows

Cast on side of channel indicate flow direction and ensure channels are installed correctly.

Sloped (0.5%) Channel Units

Meter long units provide 131'-3" continuous slope - equates to 1/17" fall per linear foot. Constant depth units can be used to extend run lengths.



System Numbering

Each end of the channel indicates the number of the channel that will connect to it.

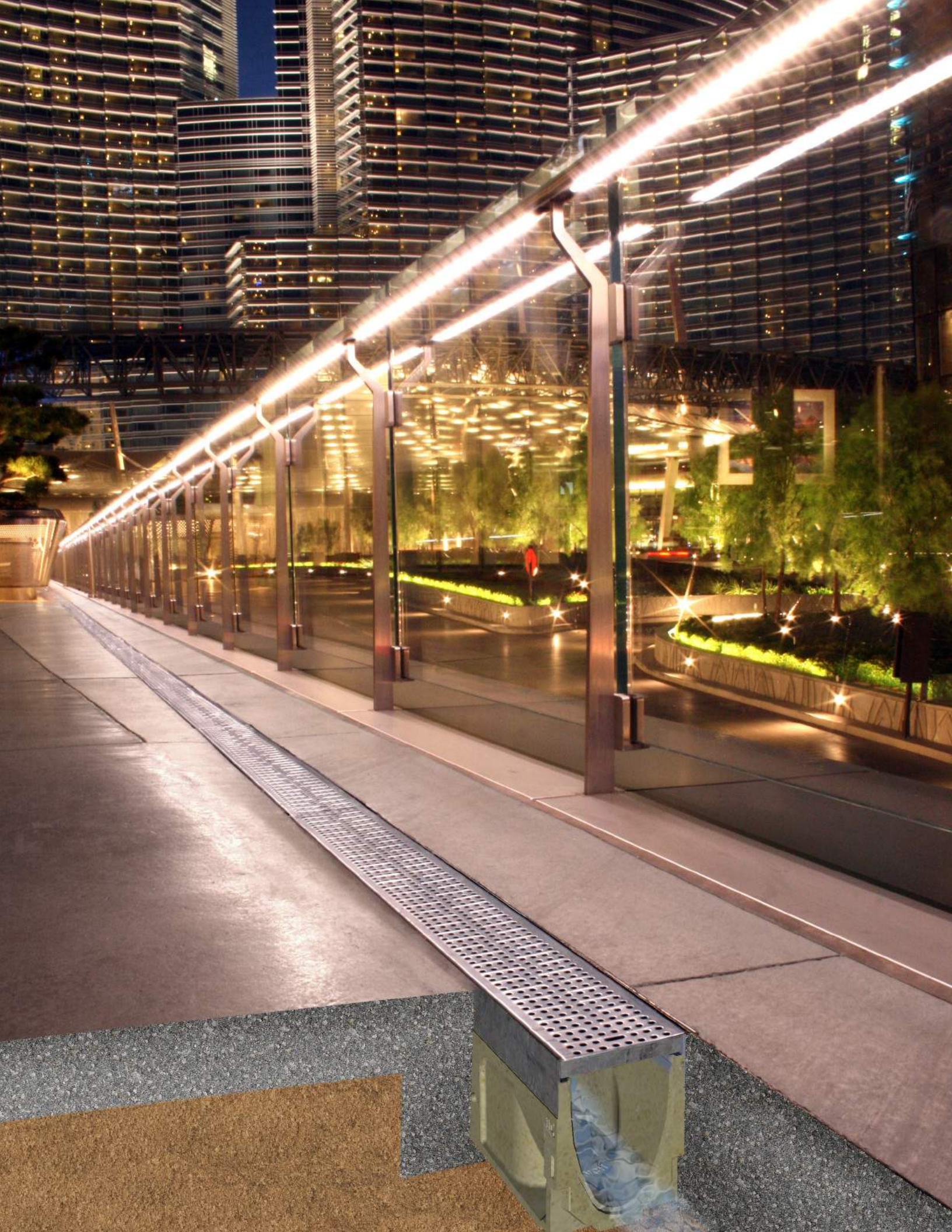

KlassikDrain K100/KS100

4" Internal Width General Purpose System

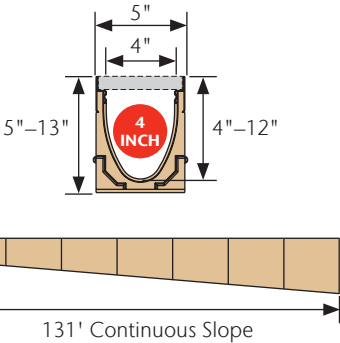













K100 is a 4" internal width, general purpose system with galvanized steel edge rail and the widest choice of grates in different materials and slot styles up to Load Class E (134,885 lbs) featuring either patented DrainLok or QuickLok® boltless locking systems.

KS100 is the same system, but the edge rail is grade 304 stainless steel. KS100 should be used where increased aesthetics are required or where increased corrosion resistance is required.

Typical Applications:

- Parking lots & garages
- Shopping malls
- Pedestrian areas
- Light industrial areas
- Commercial areas
- Internal applications

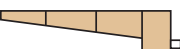
KLASSIKDRAIN K100/KS100 SELECTION CRITERIA

		Light to industrial duty loads	
		Product can be used towards LEED & EPA requirements	
		Resistant to many everyday chemicals	
			Multiple grate options to meet legal requirements
			Multiple grate options to meet design requirements
		General, everyday hydraulic capacity	
		Constant depth and/or sloped depth channels	
			



K100/KS100 System Layout

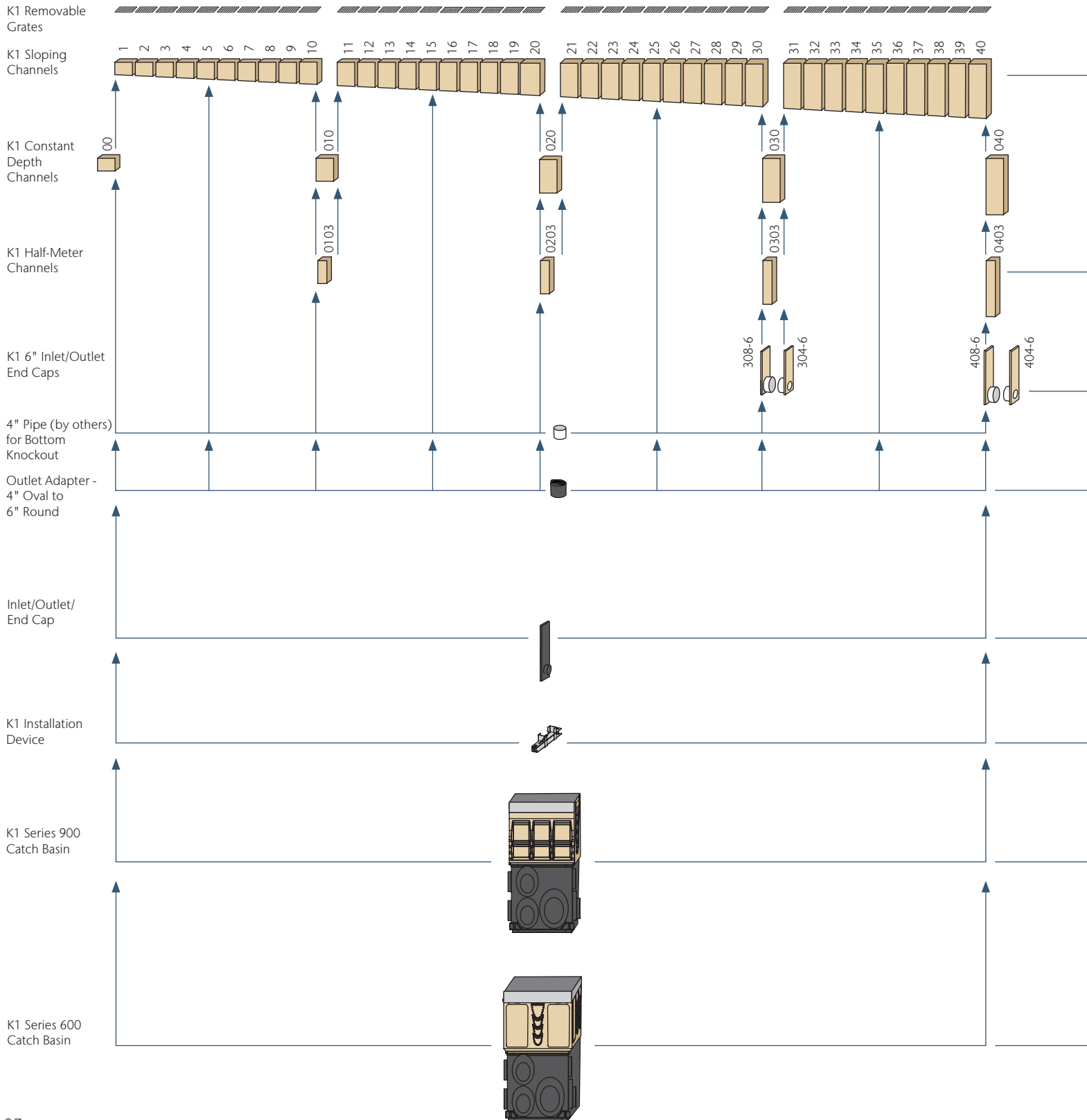

K1 Meter Channels - Sloping & Constant Depth

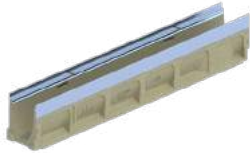

0.5% sloped channels in meter lengths and 40 depths which connect to create 40 meter (131'-2") continuously sloping run. Available with either galvanized or stainless steel edge rail.

Constant depth channels available in 5 depths. Can be used to create non-sloped runs, or inserted in sloped runs to increase length.

Bottom knockouts on all constant depths and 5, 10, 15, 20, 25, 30, 35, 40 channels.

K1 Half-Meter Channels



Constant depth channels in 4 depths supplement meter channels. Side knockout and profiling enable side junction to be created. Bottom knockouts on all half meter channels. Available with either galvanized or stainless steel edge rail.

K1 6" SCH 40 Inlet/Outlet End Cap



6" SCH 40 plain end plastic pipe; oval to round adapter cast into polymer concrete end cap and available in two heights. Solvent weld to coupler.

Note: These end caps cannot be cut to height, and fit only at positions shown in layout diagram.

Outlet Adapter - 4" Oval to 6" Round



Oval to round plastic adapter for bottom drill-out on 4" polymer concrete channels. SCH 40 6" plain end can be solvent welded to underground pipe system. Seal to channel using appropriate flexible sealant.

K1 Universal Inlet/Outlet/End Cap



Fits all channels and manufactured from ABS plastic to complement edge rail. Guides aid cutting to correct height. Wings clip cap onto end of channel. 4" bell end connection to SCH 40 pipe. Seal using PVC-ABS cement.

Note: ACO recommends removal of unused sections of bell end to ensure adequate pavement material coverage.

K1 Installation Device



Fits molded recesses on body of channel. Provides height and joint alignment - a sliding clamp locks the two channels together. Bolt to rebar on either side of channel to hold channels in place during concrete pour. Not reusable; it is encased within concrete pour.

K1 Series 900 In-Line Catch Basins



Two-part in-line catch basin with either a plastic base with 4", 6" and 8" drill-outs for pipe connection or a polymer concrete base. Supplied with plastic trash bucket. Options include an in-line or side foul air trap. Available with either galvanized or stainless steel edge rail.

Any channel can be connected into the catch basin by removing the end wall to the correct height with a box cutter. Cut-out guides provided for connection to channels 00, 010, 020, 030 and 040. All cut-outs to receive male channel ends. One blanking end plate supplied with each in-line catch basin.

K1 Series 600 Catch Basins



Two-part catch basin; bases have either a plastic base with 4", 6" and 8" drill-outs for pipe connection or a polymer concrete base. Supplied with plastic trash bucket. Optional riser available for increased depth. Available with either galvanized or stainless steel edge rail.

Any channel can be connected to catch basin by removing end/side wall to correct height. Drill-outs guide connection to channels 00, 010, 020, 030 and 040. All cut-outs to receive male channel ends.

Dimensions & Outlet Flow Rates

K1 Meter Channels

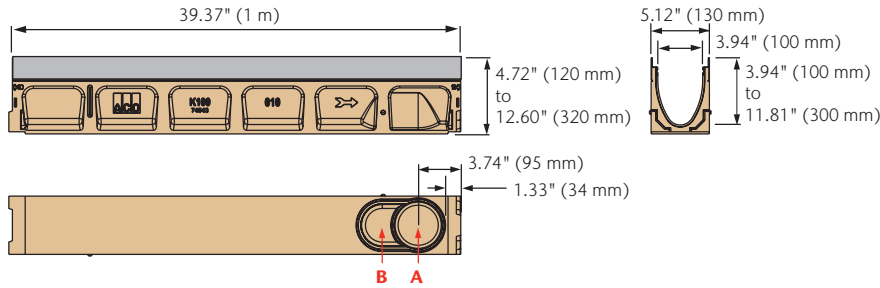

K1 Half-Meter Channels

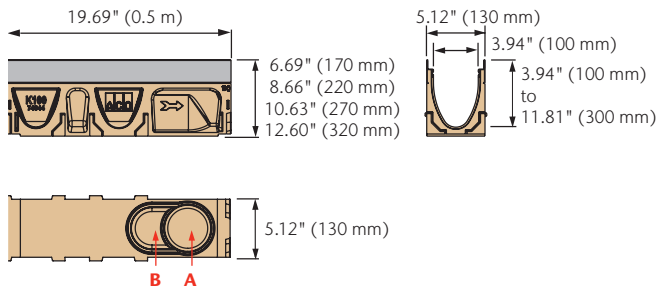

K1 Universal Inlet/Outlet/End Cap

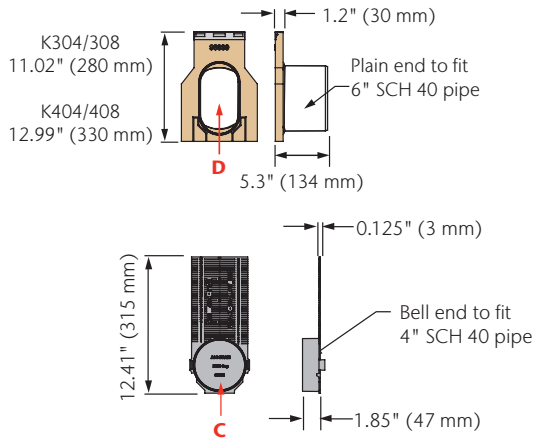

K1 Installation Device

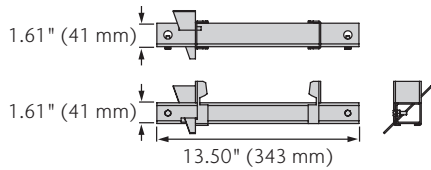

OUTLET FLOW RATES

Channel Outlet	Channel	Size (SCH 40)	Invert in	GPM	CFS
A	K1-00	4" round	3.94	108	0.24
	K1-40	4" round	11.81	187	0.42
B	K1-00	6" oval	3.94	177	0.39
	K1-40	6" oval	11.81	306	0.68
C	K1-20	4" round	7.87	132	0.29
	K1-40	4" round	11.81	171	0.38
D	K1-30	6" oval	9.84	233	0.52
	K1-40	6" oval	11.81	264	0.59

Note: These are pipe flow rates at specified outlet, NOT channel flow rates.

K100/KS100 Parts

	Part No.		Invert Depth				Overall Depth				Volume gal	Weight lbs
	K100	KS100	in		mm		in		mm			
			female	male	female	male	female	male	female	male		
K1-00 Constant Depth Channel - 39.37" (1 m)*	74041	74441	3.94	3.94	100	100	4.72	4.72	120	120	1.96	28.1
K1-1 Sloped Channel - 39.37" (1 m)	74001	74401	3.94	4.13	100	105	4.72	4.92	120	125	1.99	28.1
K1-2 Sloped Channel - 39.37" (1 m)	74002	74402	4.13	4.33	105	110	4.92	5.12	125	130	2.04	28.9
K1-3 Sloped Channel - 39.37" (1 m)	74003	74403	4.33	4.53	110	115	5.12	5.31	130	135	2.13	29.7
K1-4 Sloped Channel - 39.37" (1 m)	74004	74404	4.53	4.72	115	120	5.31	5.51	135	140	2.23	30.5
K1-5 Sloped Channel - 39.37" (1 m)*	74005	74405	4.72	4.92	120	125	5.51	5.71	140	145	2.33	31.3
K1-6 Sloped Channel - 39.37" (1 m)	74006	74406	4.92	5.12	125	130	5.71	5.91	145	150	2.43	32.1
K1-7 Sloped Channel - 39.37" (1 m)	74007	74407	5.12	5.31	130	135	5.91	6.10	150	155	2.54	32.9
K1-8 Sloped Channel - 39.37" (1 m)	74008	74408	5.31	5.51	135	140	6.10	6.30	155	160	2.65	33.7
K1-9 Sloped Channel - 39.37" (1 m)	74009	74409	5.51	5.71	140	145	6.30	6.50	160	165	2.75	34.5
K1-10 Sloped Channel - 39.37" (1 m)*	74010	74410	5.71	5.91	145	150	6.50	6.69	165	170	2.86	35.3
K1-010 Constant Depth Channel - 39.37" (1 m)*	74043	74443	5.91	5.91	150	150	6.69	6.69	170	170	2.85	35.3
K1-0103 Constant Depth Channel - 19.69" (0.5 m)*	74044	74444	5.91	5.91	150	150	6.69	6.69	170	170	1.43	17.0
K1-11 Sloped Channel - 39.37" (1 m)	74011	74411	5.91	6.10	150	155	6.69	6.89	170	175	2.97	36.1
K1-12 Sloped Channel - 39.37" (1 m)	74012	74412	6.10	6.30	155	160	6.89	7.09	175	180	3.08	36.9
K1-13 Sloped Channel - 39.37" (1 m)	74013	74413	6.30	6.50	160	165	7.09	7.28	180	185	3.19	37.7
K1-14 Sloped Channel - 39.37" (1 m)	74014	74414	6.50	6.69	165	170	7.28	7.48	185	190	3.30	38.5
K1-15 Sloped Channel - 39.37" (1 m)*	74015	74415	6.69	6.89	170	175	7.48	7.68	190	195	3.42	39.3
K1-16 Sloped Channel - 39.37" (1 m)	74016	74416	6.89	7.09	175	180	7.68	7.87	195	200	3.53	40.1
K1-17 Sloped Channel - 39.37" (1 m)	74017	74417	7.09	7.28	180	185	7.87	8.07	200	205	3.64	40.9
K1-18 Sloped Channel - 39.37" (1 m)	74018	74418	7.28	7.48	185	190	8.07	8.27	205	210	3.75	41.7
K1-19 Sloped Channel - 39.37" (1 m)	74019	74419	7.48	7.68	190	195	8.27	8.46	210	215	3.86	42.5
K1-20 Sloped Channel - 39.37" (1 m)*	74020	74420	7.68	7.87	195	200	8.46	8.66	215	220	3.98	43.4
K1-020 Constant Depth Channel - 39.37" (1 m)*	74045	74445	7.87	7.87	200	200	8.66	8.66	220	220	3.97	43.4
K1-0203 Constant Depth Channel - 19.69" (0.5 m)*	74046	74446	7.87	7.87	200	200	8.66	8.66	220	220	1.98	20.5
K1-21 Sloped Channel - 39.37" (1 m)	74021	74421	7.87	8.07	200	205	8.66	8.86	220	225	4.09	44.2
K1-22 Sloped Channel - 39.37" (1 m)	74022	74422	8.07	8.27	205	210	8.86	9.06	225	230	4.20	45.0
K1-23 Sloped Channel - 39.37" (1 m)	74023	74423	8.27	8.46	210	215	9.06	9.25	230	235	4.32	45.8
K1-24 Sloped Channel - 39.37" (1 m)	74024	74424	8.46	8.66	215	220	9.25	9.45	235	240	4.42	46.6
K1-25 Sloped Channel - 39.37" (1 m)*	74025	74425	8.66	8.86	220	225	9.45	9.65	240	245	4.54	47.4
K1-26 Sloped Channel - 39.37" (1 m)	74026	74426	8.86	9.06	225	230	9.65	9.84	245	250	4.66	48.2
K1-27 Sloped Channel - 39.37" (1 m)	74027	74427	9.06	9.25	230	235	9.84	10.04	250	255	4.78	49.0
K1-28 Sloped Channel - 39.37" (1 m)	74028	74428	9.25	9.45	235	240	10.04	10.24	255	260	4.89	49.8
K1-29 Sloped Channel - 39.37" (1 m)	74029	74429	9.45	9.65	240	245	10.24	10.43	260	265	5.00	50.6
K1-30 Sloped Channel - 39.37" (1 m)*	74030	74430	9.65	9.84	245	250	10.43	10.63	265	270	5.11	51.4
K1-030 Constant Depth Channel - 39.37" (1 m)*	74047	74447	9.84	9.84	250	250	10.63	10.63	270	270	5.10	51.4
K1-0303 Constant Depth Channel - 19.69" (0.5 m)*	74048	74448	9.84	9.84	250	250	10.63	10.63	270	270	2.55	24.0
K1-31 Sloped Channel - 39.37" (1 m)	74031	74431	9.84	10.04	250	255	10.63	10.83	270	275	5.23	52.2
K1-32 Sloped Channel - 39.37" (1 m)	74032	74432	10.04	10.24	255	260	10.83	11.02	275	280	5.34	53.0
K1-33 Sloped Channel - 39.37" (1 m)	74033	74433	10.24	10.43	260	265	11.02	11.22	280	285	5.45	53.8
K1-34 Sloped Channel - 39.37" (1 m)	74034	74434	10.43	10.63	265	270	11.22	11.42	285	290	5.56	54.6
K1-35 Sloped Channel - 39.37" (1 m)*	74035	74435	10.63	10.83	270	275	11.42	11.61	290	295	5.68	55.4
K1-36 Sloped Channel - 39.37" (1 m)	74036	74436	10.83	11.02	275	280	11.61	11.81	295	300	5.79	56.2
K1-37 Sloped Channel - 39.37" (1 m)	74037	74437	11.02	11.22	280	285	11.81	12.01	300	305	5.91	57.0
K1-38 Sloped Channel - 39.37" (1 m)	74038	74438	11.22	11.42	285	290	12.01	12.20	305	310	6.02	57.9
K1-39 Sloped Channel - 39.37" (1 m)	74039	74439	11.42	11.61	290	295	12.20	12.40	310	315	6.13	58.7
K1-40 Sloped Channel - 39.37" (1 m)*	74040	74440	11.61	11.81	295	300	12.40	12.60	315	320	6.25	59.5
K1-040 Constant Depth Channel - 39.37" (1 m)*	74049	74449	11.81	11.81	300	300	12.60	12.60	320	320	6.24	59.5
K1-0403 Constant Depth Channel - 19.69" (0.5 m)*	74050	74450	11.81	11.81	300	300	12.60	12.60	320	320	3.12	27.5
K1-304-6 6" Inlet Cap	96839	96844	9.84	9.84	250	250	11.02	11.02	280	280	-	5.2
K1-308-6 6" Outlet Cap	96840	96845	9.84	9.84	250	250	11.02	11.02	280	280	-	5.0
K1-404-6 6" Inlet Cap	96834	96846	11.81	11.81	300	300	12.99	12.99	330	330	-	6.0
K1-408-6 6" Outlet Cap	96836	96847	11.81	11.81	300	300	12.99	12.99	330	330	-	5.8
K1 Universal Inlet/Outlet/End Cap	96822	-	11.81	11.81	300	300	12.40	12.40	315	315	-	0.4
K1 Debris Strainer for 4" Bottom Knockout ³	93488	-	-	-	-	-	-	-	-	-	-	0.2
Outlet Adapter - 4" Oval to 6" Round	95140	-	-	-	-	-	-	-	-	-	-	1.1
K1 Installation device	97477	-	-	-	-	-	-	-	-	-	-	2.8
Grate Removal Tool	01318	-	-	-	-	-	-	-	-	-	-	0.3
K1 QuickLok® Locking Bar	02899	-	-	-	-	-	-	-	-	-	-	0.1

Notes:

1. K100 has a galvanized steel edge rail for general use. KS100 has a grade 304 stainless steel edge rail for use where increased aesthetics or corrosion resistance is required.
 2. KlassikDrain is sold as channel only. Choose appropriate grate from pages 35-38.
 3. Debris strainer details for 4" dia. outlet on page 138.
 4. See Catch Basin Parts List on page 29.
- *This channel features 4" & 6" bottom knockouts.

Catch Basin Assemblies & Part Details

Polymer concrete catch basins can be used as standalone area drains or as the outlet to a trench run. They provide the highest hydraulic output and allow access to the pipe system for maintenance.

Series 900 catch basins are **in-line catch basins** (same width and visually indistinguishable from the trench run) while Series 600 catch basins are 12" wide, providing greater hydraulic output.

CATCH BASIN LOAD STRENGTH

Catch basins with plastic risers/bases should be used in load classes A–D. For heavy duty applications, ACO recommends using polymer concrete risers and catch basins for load class E/F applications.

K100/KS100 Catch Basin Parts

	Part No.		Volume*	Weight
	K100	KS100		
K1-901 In-Line Catch Basin w/ Plastic Base	94608	94609	12.3	52.6
K1-906 In-Line Catch Basin w/ Polymer Concrete Base	97934	97935	11.1	113.4
K1-621 Catch Basin w/ Plastic Base	94617	94618	24.9	55.8
K1-622 Catch Basin w/ Polymer Concrete Base	97915	97916	25.1	137.5
K1-631 Catch Basin w/ Plastic Riser & Base	94631	94632	34.7	65.8
K1-632 Catch Basin w/ Polymer Concrete Riser & Base	97925	97926	34.0	183.0
Series 600 Plastic Riser	99902		9.8	10.0
Series 611 Polymer Concrete Riser	91110		8.9	45.0
Foul Air Trap (fits all plastic basins)	90854		-	1.2

*Volume is up to grate seat and without trash bucket.

BLANKING END PLATES

Blanking plates are supplied with catch basin tops to stop concrete ingress at end of drain run. The plate is fitted by pushing it over the polymer concrete end bar to fit flush with side rails.



FOUL AIR TRAP

A plastic foul air trap that fits into the front or side of plastic in-line catch basins. A coupler is required to connect SCH 40 4" plain end pipe to underground pipe system.

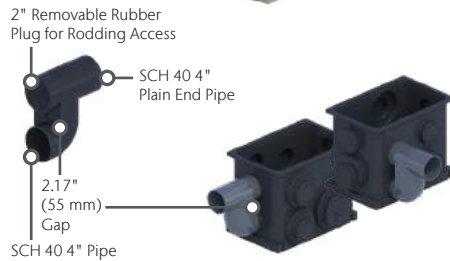

CATCH BASIN CHANNEL CONNECTION

Channels can be connected to catch basin on all four sides in a variety of configurations.

Series 900

Series 600

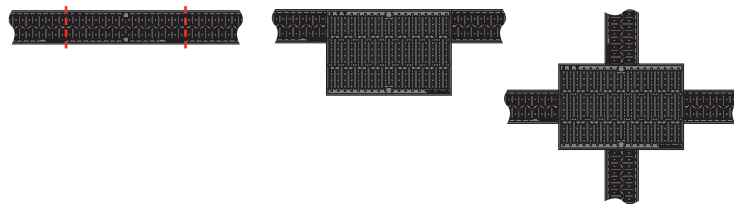

K1 SERIES 900 4" WIDE IN-LINE CATCH BASINS

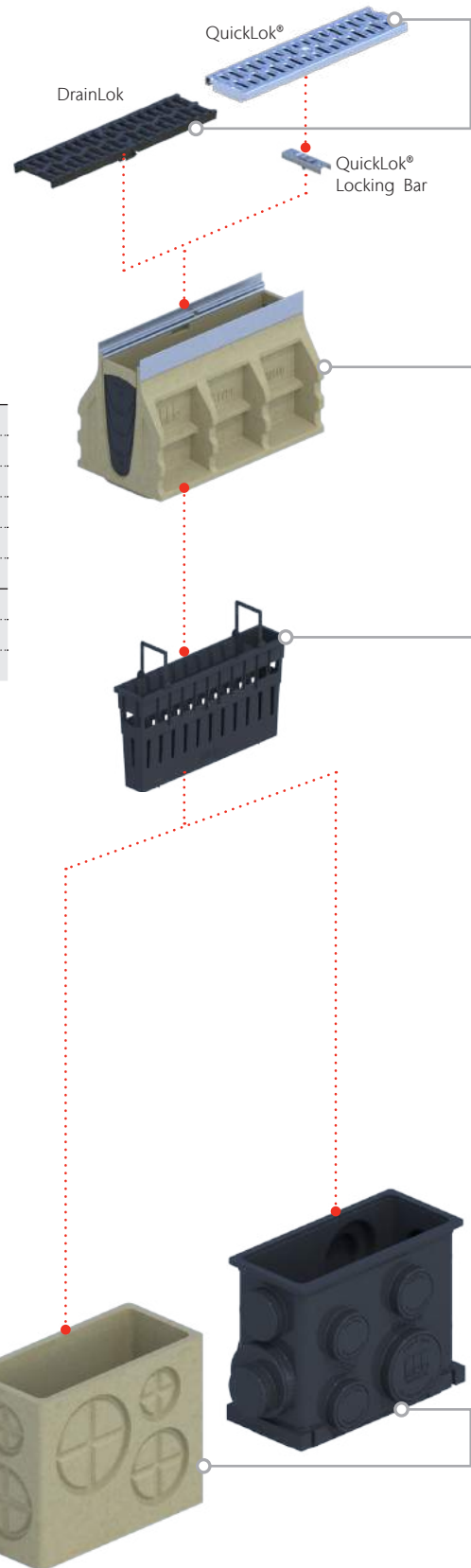

**K1 SERIES 600 12" WIDE
CATCH BASINS**

Series 600 Grates - choice of grates to match/complement channel with DrainLok or QuickLok® boltless locking. See page 77–78. All catch basin assemblies will include one QuickLok® Locking Bar.

Series 900 Grates - choice of grates to match channel grates with DrainLok or QuickLok® boltless locking. See page 35–38. QuickLok® grates are often paired with removable QuickLok® locking bars for easy access to trash bucket and pipework. One is included in each catch basin assembly.

Top Section - polymer concrete with integrally cast-in galvanized or stainless steel frame. Guides aid connection of male channel ends at #10, 20, 30 and 40 depths. Other channels can be connected by removing wall to required height. Blanking kit supplied with in-line catch basins.

Trash Bucket - plastic trash bucket designed to collect debris washed from trench run. Supported in catch basin top to avoid creation of a vacuum and reduction in outflow. K1-631 and K1-632 use a deeper bucket with riser.

Riser - a plastic or polymer concrete riser supplied with K1-631 and K1-632, designed to provide additional catch basin depth and hydraulic output. Guides on the plastic version enable cutting to size at 2" (50 mm) intervals - minimum 2" and maximum 12" height. Additional units can be used (a maximum of 2 is recommended to ensure snake access is maintained and for structural stability).

Multiple risers can be used with series 600 catch basins.



Base - Plastic or polymer concrete bases available. Plastic bases have a wide range of SCH 40 4", 6" and 8" cut-outs for easy pipe connection. Cut-outs on end and side allow connection of ACO foul air trap. Polymer concrete bases have drill-outs cast on the sides for pipe connections.



Catch Basin Dimensions & Outlet Flow Rates

K1-901G/S In-Line Catch Basin

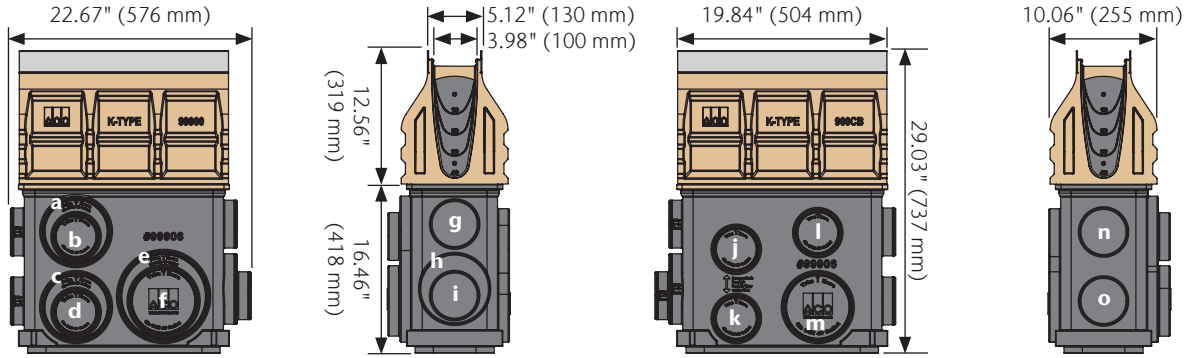

Catch Basin Outlet	Size (SCH 40)	Invert in	GPM	CFS
a	6"	19.99	505	1.12
b	4"	19.36	227	0.51
c	6"	27.30	604	1.35
d	4"	26.43	269	0.60
e	8"	27.30	1051	2.34
f	6"	26.43	593	1.32

Catch Basin Outlet	Size (SCH 40)	Invert in	GPM	CFS
g	4"	18.56	222	0.49
h	6"	25.85	586	1.30
i	4"	25.30	263	0.59

Catch Basin Outlet	Size (SCH 40)	Invert in	GPM	CFS
j	4"	20.68	235	0.52
k	4"	27.17	273	0.61
l	4"	18.99	224	0.50
m	6"	27.17	602	1.34

Catch Basin Outlet	Size (SCH 40)	Invert in	GPM	CFS
n	4"	19.30	226	0.50
o	4"	25.67	265	0.59

K1-906G/S In-Line Catch Basin

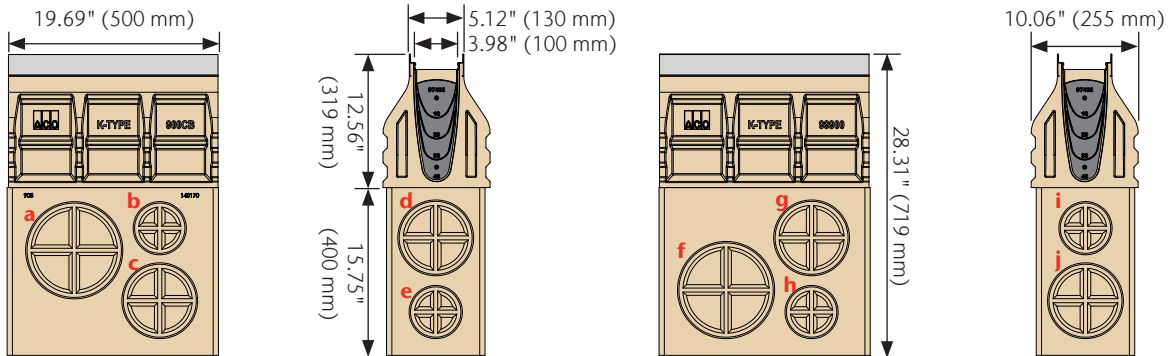

Catch Basin Outlet	Size (SCH 40)	Invert in	GPM	CFS
a	8"	22.43	934	2.15
b	4"	18.36	220	0.51
c	6"	26.17	589	1.36

Catch Basin Outlet	Size (SCH 40)	Invert in	GPM	CFS
d	6"	20.26	509	1.17
e	4"	26.23	268	0.62

Catch Basin Outlet	Size (SCH 40)	Invert in	GPM	CFS
f	8"	26.17	1025	2.36
g	6"	20.26	509	1.17
h	4"	26.23	268	0.62

Catch Basin Outlet	Size (SCH 40)	Invert in	GPM	CFS
i	4"	18.36	220	0.51
j	6"	26.17	589	1.36

Note: These are pipe flow rates at specified outlets, NOT channel flow rates. Catch basin flow rates are listed without a trash bucket—using a trash bucket reduces flow.

K1-621G/S Catch Basin

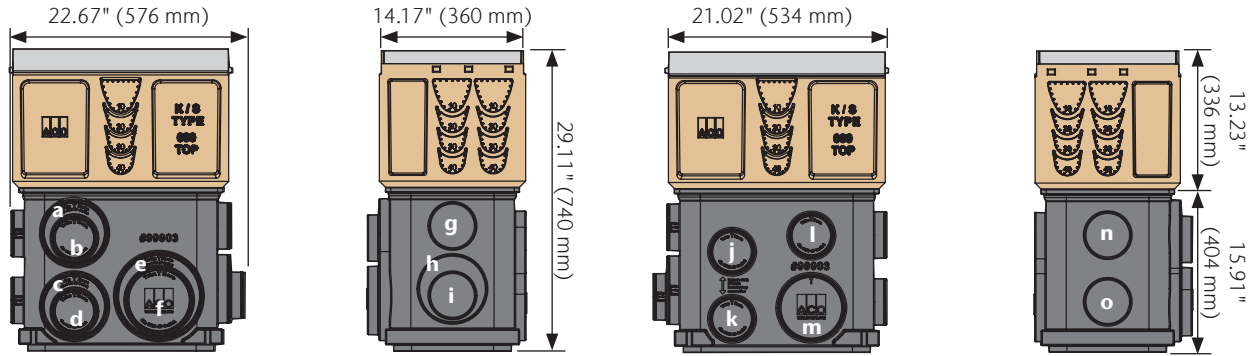

Catch Basin Outlet	Size (SCH 40)	Invert in	GPM	CFS
a	6"	20.62	514	1.15
b	4"	20.07	231	0.52
c	6"	27.76	609	1.36
d	4"	27.19	273	0.61
e	8"	27.76	1061	2.36
f	6"	27.19	602	1.34

Catch Basin Outlet	Size (SCH 40)	Invert in	GPM	CFS
g	4"	19.15	225	0.50
h	6"	26.28	591	1.32
i	4"	25.86	266	0.59

Catch Basin Outlet	Size (SCH 40)	Invert in	GPM	CFS
j	4"	21.29	239	0.53
k	4"	27.79	276	0.62
l	4"	19.72	229	0.51
m	6"	27.79	610	1.36

Catch Basin Outlet	Size (SCH 40)	Invert in	GPM	CFS
n	4"	19.84	230	0.51
o	4"	26.34	269	0.60

K1-622G/S Catch Basin

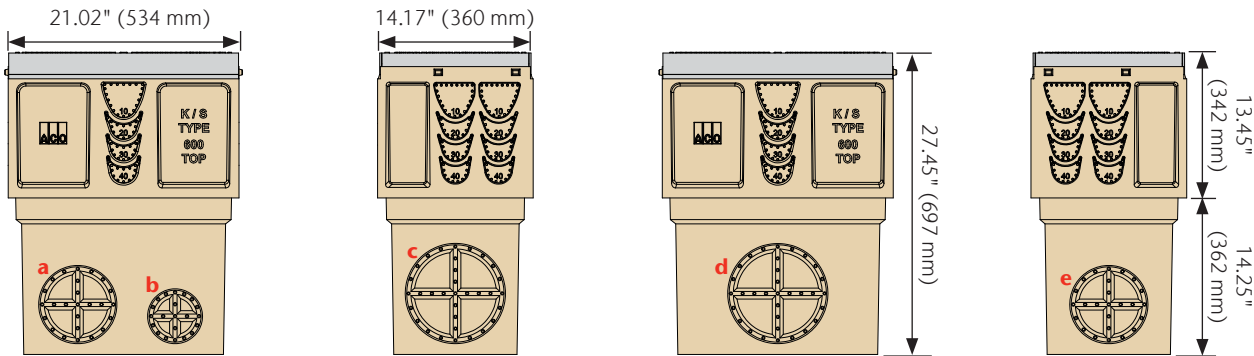

Catch Basin Outlet	Size (SCH 40)	Invert in	GPM	CFS
a	6"	25.96	587	1.35
b	4"	26.02	267	0.61

Catch Basin Outlet	Size (SCH 40)	Invert in	GPM	CFS
c	8"	25.96	1020	2.35

Catch Basin Outlet	Size (SCH 40)	Invert in	GPM	CFS
d	8"	25.96	1020	2.35

Catch Basin Outlet	Size (SCH 40)	Invert in	GPM	CFS
e	6"	25.96	587	1.35

Note: These are pipe flow rates at specified outlets, NOT channel flow rates. Catch basin flow rates are listed without a trash bucket—using a trash bucket reduces flow.

Underside

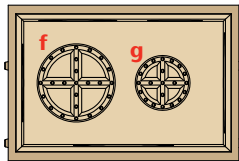

Catch Basin Outlet	Size (SCH 40)	Invert in	GPM	CFS
f	6"	27.45	641	1.48
g	4"	27.45	285	0.66

Catch Basin Dimensions & Outlet Flow Rates (cont.)

K1-631G/S Catch Basin

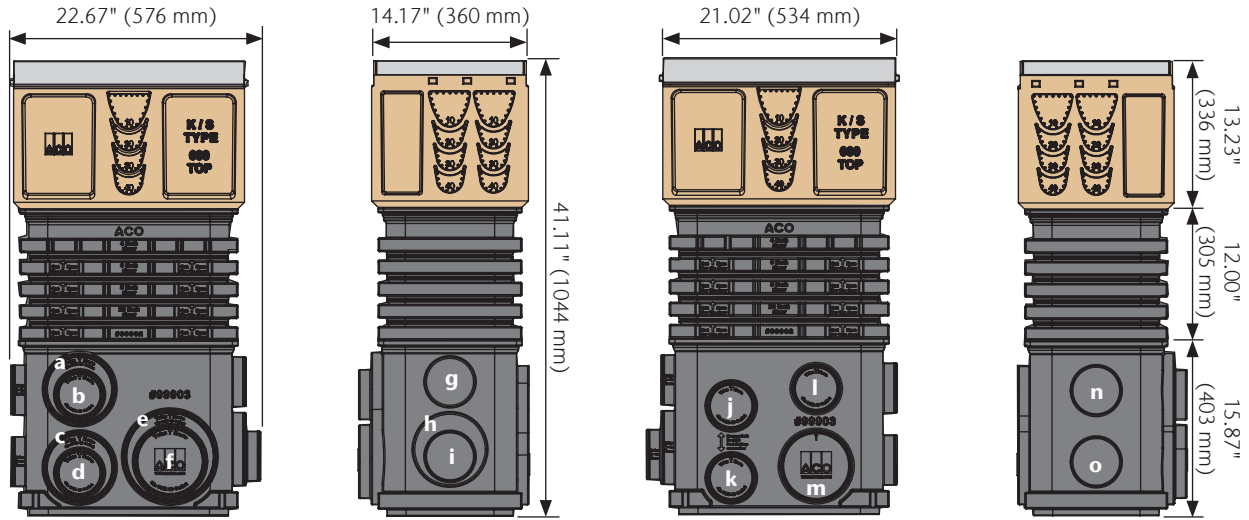

Catch Basin Outlet	Size (SCH 40)	Invert in	GPM	CFS
a	6"	32.62	667	1.49
b	4"	32.07	299	0.67
c	6"	39.76	743	1.65
d	4"	39.19	332	0.74
e	8"	39.76	1302	2.90
f	6"	39.19	737	1.64

Catch Basin Outlet	Size (SCH 40)	Invert in	GPM	CFS
g	4"	31.15	294	0.65
h	6"	38.28	728	1.62
i	4"	37.86	326	0.73

Catch Basin Outlet	Size (SCH 40)	Invert in	GPM	CFS
j	4"	33.29	305	0.68
k	4"	39.79	335	0.75
l	4"	31.72	297	0.66
m	6"	39.79	743	1.66

Catch Basin Outlet	Size (SCH 40)	Invert in	GPM	CFS
n	4"	31.84	297	0.66
o	4"	38.34	328	0.73

K1-632G/S Catch Basin

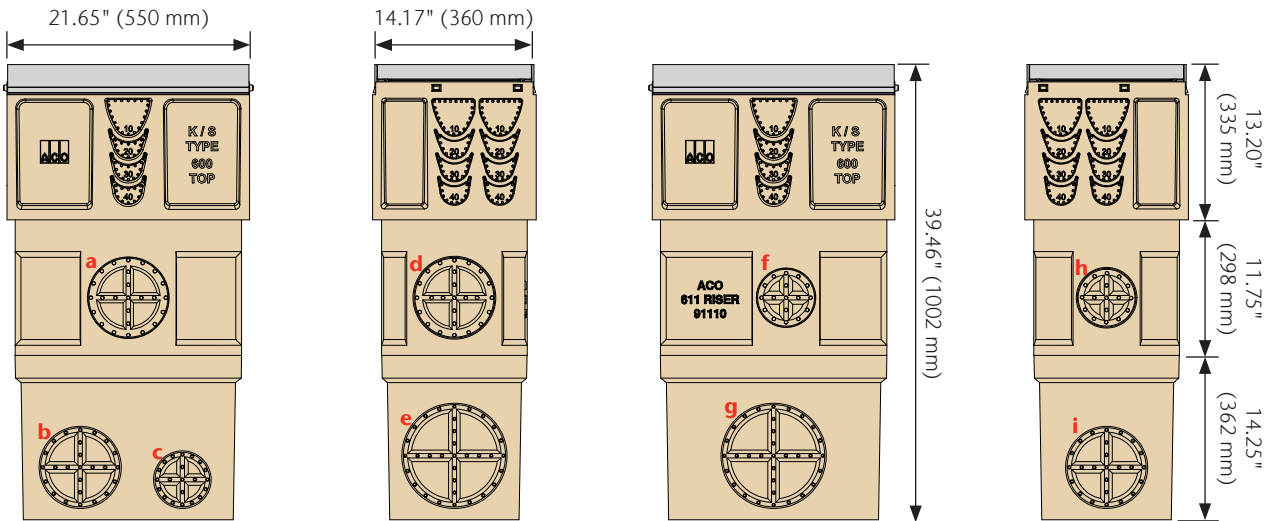

Catch Basin Outlet	Size (SCH 40)	Invert in	GPM	CFS
a	6"	23.20	550	1.27
b	6"	37.90	723	1.66
c	4"	37.96	326	0.75

Catch Basin Outlet	Size (SCH 40)	Invert in	GPM	CFS
d	6"	23.20	551	1.27
e	8"	37.90	1267	2.91

Catch Basin Outlet	Size (SCH 40)	Invert in	GPM	CFS
f	4"	22.20	245	0.56
g	8"	37.90	1267	2.91

Catch Basin Outlet	Size (SCH 40)	Invert in	GPM	CFS
h	4"	22.20	245	0.56
i	6"	37.90	723	1.66

Note: These are pipe flow rates at specified outlets, NOT channel flow rates. Catch basin flow rates are listed without a trash bucket—using a trash bucket reduces flow.

Underside

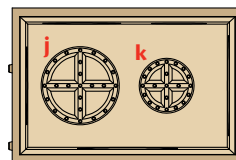

Catch Basin Outlet	Size (SCH 40)	Invert in	GPM	CFS
j	6"	39.45	769	1.77
k	4"	39.45	342	0.79



MADAME TUSSAUDS

Hollywood, CA
United States

Madame Tussauds Hollywood is a wax museum and tourist attraction located on Hollywood Boulevard in Hollywood, California. It is the ninth location for the Tussauds franchise, which was set up by sculptor Marie Tussaud. KlassikDrain KS100 and Type 447 stainless steel longitudinal grates were used to stop stormwater from running into both Madame Tussauds and onto the Walk of Fame where over 10 million tourists visit each year.

PORTFOLIO

K100/KS100 Grates - DrainLok

KEY



ADA Compliant
Compliant with Americans with Disabilities Act of 2010, Section 302.3 (page 174)



Heel-Resistant
ASME A112.6.3 - 2001 Heel-resistant slot width less than 0.31" (8 mm) (page 174)



Heel-Safe
Heel-safe slot width equal or less than 0.25" (6.5 mm) (page 174)



Slip-Resistant Grates
BPN over 24 (page 174)



Bicycle-Safe
Compliant to Australian Standard AS 3996 - 2006 (page 174)



Non-Metallic
No metallic/magnetic parts included (page 170)

For details on how psi is determined, see pages 161-166.



LOAD CLASS A (EN 1433 - 15 KN) - 3,372 LBS - 70 PSI (PEDESTRIAN TRAFFIC)

PERFORATED STEEL

	Part No.	Length in (m)	Slot Size in	Intake Area in ²	Weight lbs					
Type 410D - Galvanized	12666	39.37 (1.0)	Ø 0.25	28.3	6.3	x				
Type 412D - Galvanized	12667	19.69 (0.5)		14.1	3.2	x				
Type 451D - Stainless ¹	12664	39.37 (1.0)		28.3	6.3	✓	✓	✓	✓	✓
Type 453D - Stainless ¹	12665	19.69 (0.5)		14.1	3.2	✓				

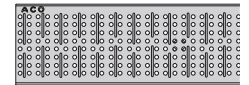

SLOTTED STEEL

Type 420D - Galvanized	12610	39.37 (1.0)	0.38 x 1.46 avg.	35.2	5.9					
Type 421D - Galvanized	12611	19.69 (0.5)		17.6	3.0					
Type 450D - Stainless ¹	12640	39.37 (1.0)		35.2	5.9	✓	x	x	x	✓
Type 452D - Stainless ¹	12641	19.69 (0.5)		17.6	3.0					

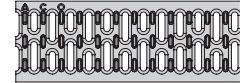

LONGITUDINAL PLASTIC²

Type 494D - Black	99575	19.69 (0.5)	1.76 x 0.34	27.4	1.8					
Type 495D - Gray	99576	19.69 (0.5)		27.4	1.8	✓	✓	x	x	✓
Type 496D - Tan	99577	19.69 (0.5)		27.4	1.8					

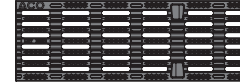

LOAD CLASS B (EN 1433 - 125 KN) - 28,101 LBS - 580 PSI (LIGHT DUTY TRAFFIC)

LONGITUDINAL STEEL (STAINLESS)¹

Type 447D - Stainless	142215	39.37 (1.0)	1.61 x 0.24	93.7	8.0	✓	✓	✓	✓	✓
Type 448D - Stainless	142216	19.69 (0.5)		46.9	4.0					

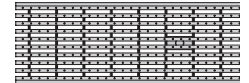

LONGITUDINAL STEEL (GALVANIZED)

Type 438D - Galvanized	132555	39.37 (1.0)	1.15 x 0.3	66.0	8.0	✓	✓	✓	x	✓
Type 437D - Galvanized	132550	19.69 (0.5)		33.0	4.0					

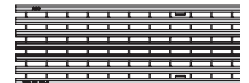

Notes

- Grade 304 stainless steel
- Polypropylene material
- Ductile iron to ASTM A536 Grade 65-45-12
- Ductile iron to ASTM A536 Grade 80-55-06

K100/KS100 Grates - DrainLok (cont.)

	Part No.	Length in (m)	Slot Size in	Intake Area in ²	Weight lbs						
LOAD CLASS C (EN 1433 - 250 KN) - 56,202 LBS - 1,160 PSI (COMMERCIAL VEHICLE TRAFFIC)											
SLOTTED PLASTIC²											
	Type 492D - Microgrip Black	132720	19.69 (0.5)	0.3 x 1.69 avg.	22.2	2.2	✓	✗	✓	✗	
SLOTTED STEEL											
	Type 425D - Galvanized	12614	39.37 (1.0)	0.38 x 1.46 avg.	35.2	10.0					
	Type 426D - Galvanized	12615	19.69 (0.5)		17.6	5.0	✓	✗	✗	✗	✓
	Type 455D - Stainless ¹	12644	39.37 (1.0)		35.2	10.0					
	Type 457D - Stainless ¹	12645	19.69 (0.5)		17.6	5.0					
PERFORATED STEEL											
	Type 411D - Galvanized	12656	39.37 (1.0)	Ø 0.25	28.3	10.0	✗				
	Type 413D - Galvanized	12657	19.69 (0.5)		14.1	5.0	✗	✓	✓	✓	✓
	Type 465D - Stainless ¹	12654	39.37 (1.0)		28.3	10.0	✓				
	Type 466D - Stainless ¹	12655	19.69 (0.5)		14.1	5.0	✓				
MESH STEEL											
	Type 405D - Galvanized	132880	39.37 (1.0)	1.20 x 0.50	121.1	9.1					
	Type 406D - Galvanized	132881	19.69 (0.5)		58.0	4.6	✓	✓	✗	✗	✓
	Type 430D - Stainless ¹	132882	39.37 (1.0)		121.1	9.2					
	Type 431D - Stainless ¹	132883	19.69 (0.5)		58.0	4.6					
SLOTTED IRON³											
	Type 460D - Iron	12670	19.69 (0.5)	0.47 x 1.58 avg.	28.3	8.0	✓	✓	✗	✗	
LONGITUDINAL IRON⁴											
	Type 476D - Iron	142171	19.69 (0.5)	2.1 x 0.24	22.6	8.4	✓	✓	✓	✓	
WAVE IRON⁴											
	Type 480D - Iron	99578	19.69 (0.5)	0.27 x 2.4 avg.	27.0	8.0	✓	✓	✓	✗	

DRAINLOK - BOLTLESS & BARLESS LOCKING SYSTEM



Factory-fitted locking device removes need for bolts and bars and improves channel hydraulic capacity. The DrainLok mechanism clips into channel edge rail for rapid installation. DrainLok grates are fit with an anti-shunt mechanism that restricts unwanted grate movement when installed, improving durability and longevity of the system.



1 Position grate onto channel and align anti-shunt detail with recess in rail.



2 Push down or stand on grate until it clicks into position.













3 To remove first grate, insert grate removal tool into slots at end of grate, pull up sharply. Remaining grates can be removed by hand.

K100/KS100 Grates - QuickLok®

KEY

 ADA Compliant Compliant with Americans with Disabilities Act of 2010, Section 302.3 (page 174)	 Heel-Resistant ASME A112.6.3 - 2001 Heel-resistant slot width less than 0.31" (8 mm) (page 174)	 Heel-Safe Heel-safe slot width equal or less than 0.25" (6.5 mm) (page 174)
 Slip-Resistant Grates BPN over 24 (page 174)	 Bicycle-Safe Compliant to Australian Standard AS 3996 - 2006 (page 174)	 Non-Metallic No metallic/magnetic parts included (page 170)

For details on how psi is determined, see pages 161-166.

	Part No.	Length in (m)	Slot Size in	Intake Area in ²	Weight lbs						
LOAD CLASS C (EN 1433 - 250 KN) - 56,202 LBS - 1,160 PSI (COMMERCIAL VEHICLE TRAFFIC)											
SLOTTED PLASTIC²											
	Type 492Q - Black	31710	19.69 (0.5)	0.3 x 1.69 avg.	22.2	3.5	✓	✗	✓	✗	✓
MOSAIC IRON⁴											
	Type 479Q - Iron	97116	19.69 (0.5)	0.43 avg.	13.0	9.6	✓	✓	✗	✗	✓
LOAD CLASS E (EN 1433 - 600 KN) - 134,885 LBS - 2,785 PSI (INDUSTRIAL TRAFFIC)											
SLOTTED IRON⁴											
	Type 461Q - Iron	96752	19.69 (0.5)	0.40 x 3.93	34.1	10.2	✓	✗	✗	✗	✓
SLOTTED STEEL											
	Type 435Q - Galvanized	31550	39.37 (1.0)	0.38 x 1.46 avg.	35.2	13.7	✓	✗	✗	✗	✓
	Type 436Q - Galvanized	31551	19.69 (0.5)		17.6	6.8					
	Type 490Q - Stainless ¹	31650	39.37 (1.0)		35.2	13.7					
	Type 493Q - Stainless ¹	31651	19.69 (0.5)		17.6	6.8					
LONGITUDINAL IRON⁴											
	Type 478Q - Iron	03314	19.69 (0.5)	1.77 x 0.27	22.5	13.3	✓	✓	✓	✗	✓

Notes

1. Grade 304 stainless steel 2. Polypropylene material 3. Ductile iron to ASTM A536 Grade 65-45-12 4. Ductile iron to ASTM A536 Grade 80-55-06

QUICKLOK® - BOLTLESS LOCKING SYSTEM



Locate locking bar in channel wall recesses by rotating clockwise.

Use hammer to tap bar into place, so that serrated ends grip in recess.

To install grate, align QuickLok® stud directly over locking bar.

Push down or stand on grate until it clicks into position.

To remove first grate, insert grate removal tool into slots at end of grate, pull up sharply. Remaining grates can be removed by hand.

To remove bar, insert screwdriver into hole at end of bar and lever back serrated end, rotate bar free.

K100/KS100 Grates - Brickslot Tops



LOAD CLASS C (EN 1433 - 250 KN) - 56,202 LBS - 1,160 PSI (COMMERCIAL VEHICLE TRAFFIC)

BRICKSLOT 100 STEEL

	Part No.	Length in (m)	Slot Size in	Area in ²	Weight lbs					
Type 441 - Galvanized	138040	39.37 (1.0)	39.4 x 0.47	18.6	17.6					
Type 442 - Galvanized	138041	19.69 (0.5)	19.7 x 0.47	9.3	9.0					
Type 443 - Stainless ¹	138045	39.37 (1.0)	39.4 x 0.47	18.6	17.6	-	✓	✗	✗	✓
Type 444 - Stainless ¹	138046	19.69 (0.5)	19.7 x 0.47	9.3	9.0					

HEEL-RESISTANT BRICKSLOT 100 STEEL

Type 470 - Galvanized	138050	39.37 (1.0)	39.4 x 0.30	24.8	18.0					
Type 471 - Galvanized	138051	19.69 (0.5)	19.7 x 0.30	12.4	9.2					
Type 472 - Stainless ¹	138055	39.37 (1.0)	39.4 x 0.30	24.8	18.0	-	✓	✓	✗	✓
Type 473 - Stainless ¹	138056	19.69 (0.5)	19.7 x 0.30	12.4	9.2					

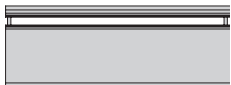



Brickslot 100

Discreet Slot & 4" Internal Width Drainage Channel

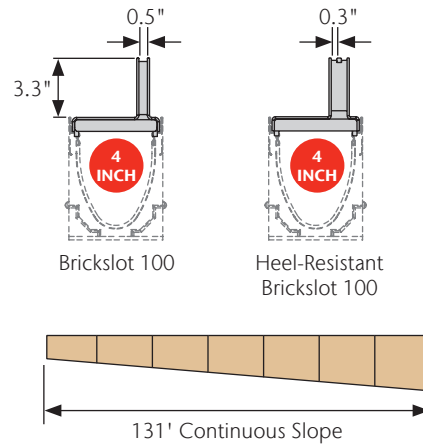

Brickslot is a discreet, galvanized steel drainage solution for use with 3.125" or less brick or stone pavers. The slots blend in with the paving joints giving an aesthetic solution.

Brickslot 100 offers a single offset slot, or a twin heel-resistant slot option.

Stainless steel Brickslot is the same system, but is manufactured entirely in grade 304 stainless steel. Stainless steel Brickslot should be used where increased aesthetics are desired, or where increased corrosion resistance is required.

Typical Applications:

- Pedestrian plazas
- Aesthetic areas
- Paved areas
- Sidewalks

BRICKSLOT 100 SELECTION CRITERIA

	Light to medium duty loads
	Product can be used towards LEED & EPA requirements
	Resistant to many everyday chemicals
	Multiple grate options to meet legal requirements
	General, everyday hydraulic capacity
	Constant depth and/or sloped depth channels



Brickslot 100 Features



Brick Pavers



Fit directly against slot. For light duty pedestrian applications, pavers can be set on sand; for heavier duty projects, pavers should be set on concrete. Maximum paver depth (allowing for 0.25" (6 mm) bedding material): 3.125" (80 mm).

0.5" (12 mm) Slot

Easy-to-clean, smooth slots allow continuous water flow into the channel. Offset, heel-resistant, double 0.31" (8 mm) flared slot opening to 1" (25 mm) throat for increased drainage capacity.

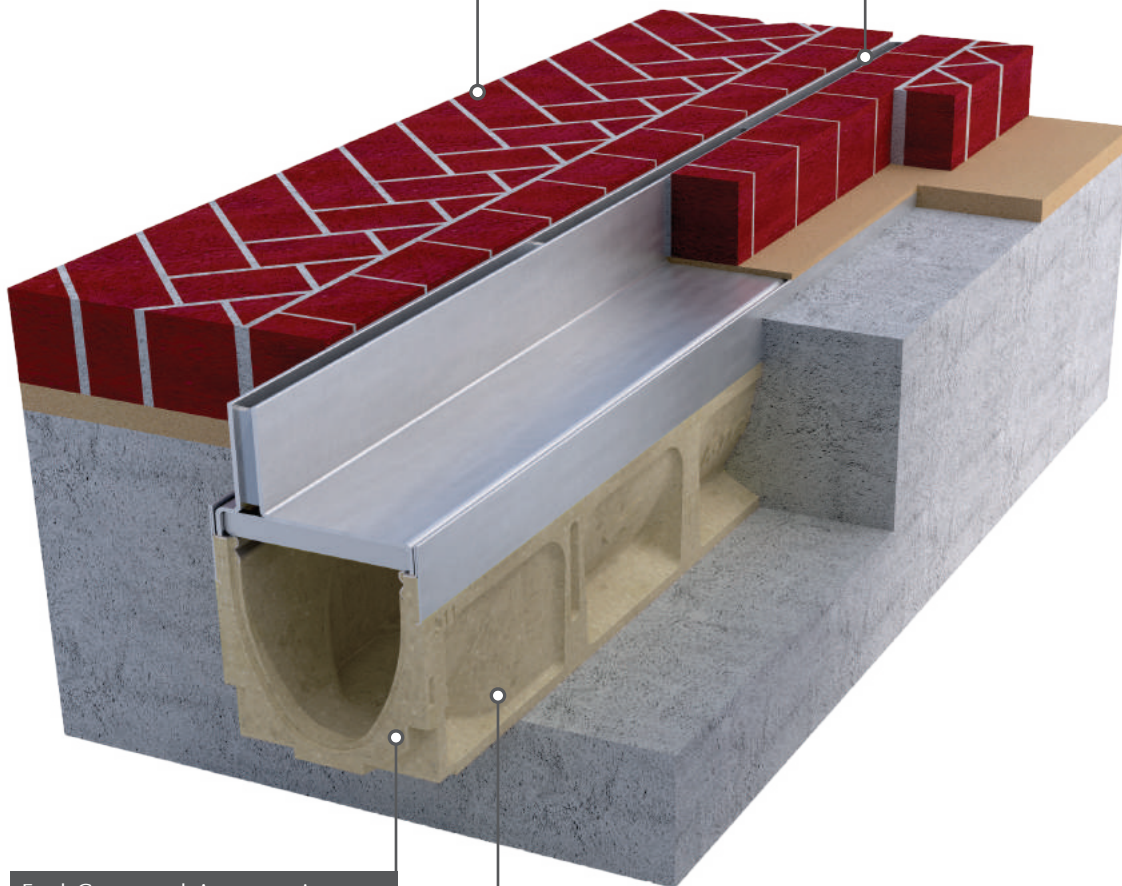

End Caps and Accessories

Available from the K100 range. See page 28 for details.

Used with K100 Channel

Brickslot fits directly into K100 channel grate recess. Half meter sections are available. Half meter access units provide access to channel or catch basin for maintenance. See page 28 for details.

Brickslot 100 Parts

	Part No.		Overall Depth in (mm)	Weight lbs	♿	👤	🚲
	Galvanized	Stainless					
Type 441/443 - Brickslot 100 - 39.37" (1 m)	138040	138045	4.06 (103)	17.6	✓	✗	✓
Type 442/444 - Brickslot 100 - 19.69" (0.5 m)	138041	138046	4.06 (103)	9.0	✓	✗	✓
Type 482/484 - Brickslot 100 - Access Unit - 19.69" (0.5 m) ³	138042	138047	4.06 (103)	16.4	✓	✗	✓
Type 470/472 - Heel-Resistant Brickslot 100 - 39.37" (1 m)	138050	138055	4.06 (103)	18.0	✓	✓	✓
Type 471/473 - Heel-Resistant Brickslot 100 - 19.69" (0.5 m)	138051	138056	4.06 (103)	9.2	✓	✓	✓
Type 483/485 - Heel-Resistant Brickslot 100 Access Unit - 19.69" (0.5 m) ³	138152	138057	4.06 (103)	11.0	✓	✓	✓
Grate Removal Tool ⁴	01318		-	0.3	-	-	-

Notes

1. For K100 channels and K1-900 catch basin information [pages 28–29](#).
2. Brickslot can also be used with SlabDrain HK channels - [see page 135](#).
3. Access unit can be used on channels or catch basins - for details please refer to separate Spec Info sheets.
4. Only access cover can be removed once Brickslot has been installed.
5. For custom slot widths, heights or materials (e.g. 316L stainless steel), ask us about our Aquaduct product line.

Brickslot 100

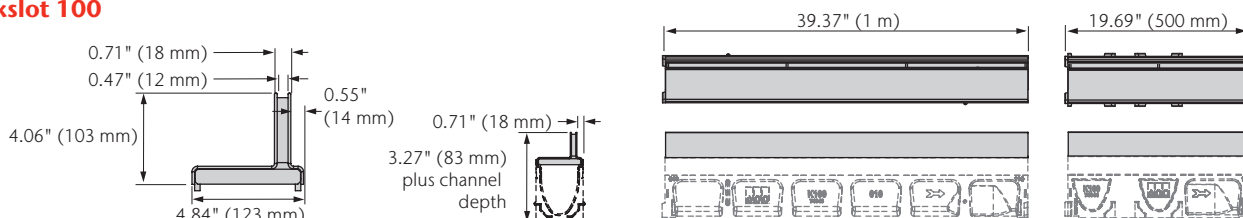

Heel-Resistant Brickslot 100

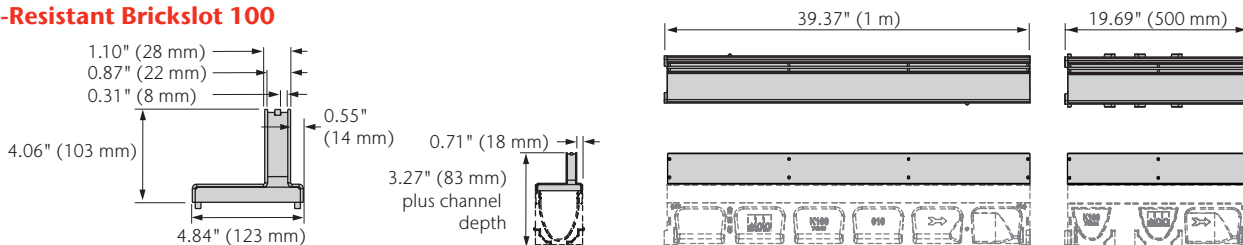

Brickslot 100 Access Unit

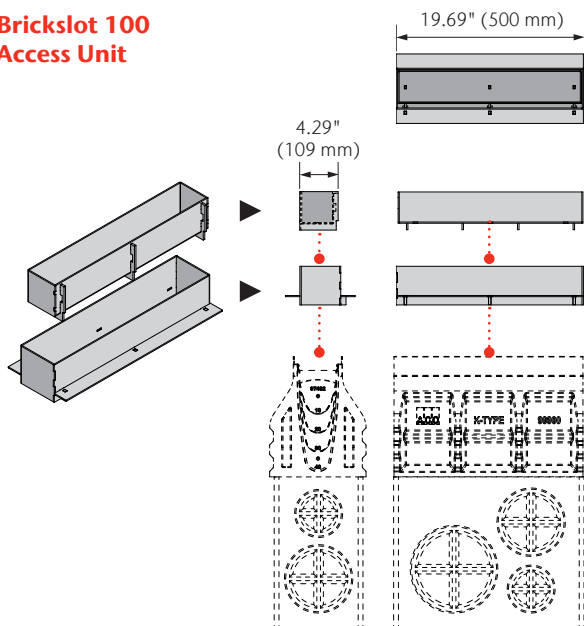

Heel-Resistant Brickslot 100 Access Unit

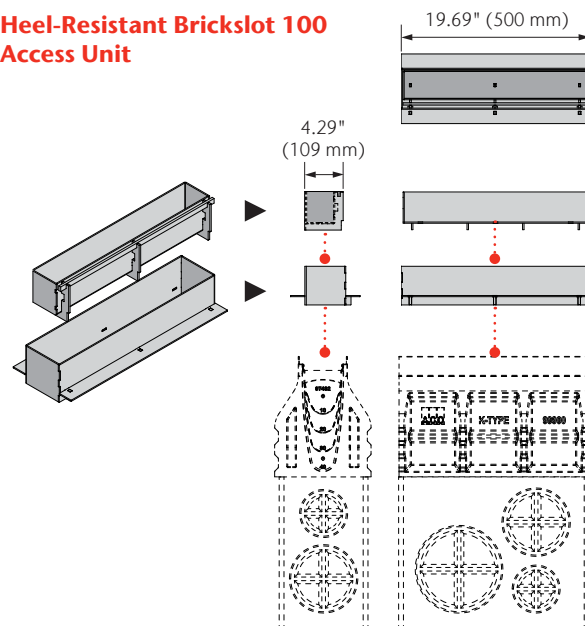



KlassikDrain K200/KS200

8" Internal Width General Purpose System

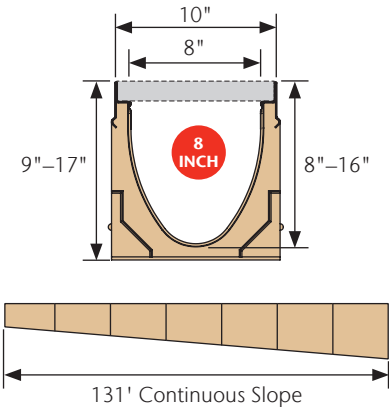
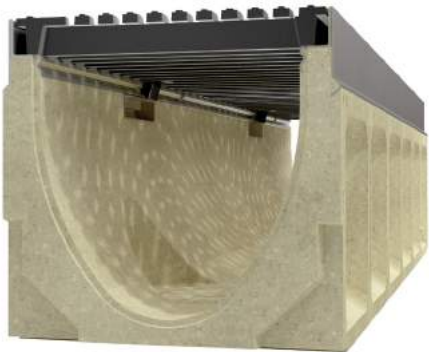

K200 is an 8" wide system with galvanized steel edge rail and wide choice of grates in different materials and slot styles up to Load Class E (60 ton) featuring either patented DrainLok or QuickLok® boltless locking systems.

KS200 is the same system, but the edge rail is grade 304 stainless steel. KS200 should be used where increased aesthetics are required, or where increased corrosion resistance is required.

Typical Applications:

- Parking lots & garages
- Shopping malls
- Pedestrian areas
- Light industrial areas
- Commercial areas
- Internal applications

KLASSIKDRAIN K200/KS200 SELECTION CRITERIA

		Light to industrial duty loads	
		Product can be used towards LEED & EPA requirements	
		Resistant to many everyday chemicals	
			Multiple grate options to meet legal requirements
			Multiple grate options to meet design requirements
		Increased hydraulic capacity	
		Constant depth and/or sloped depth channels	



K200/KS200 System Layout

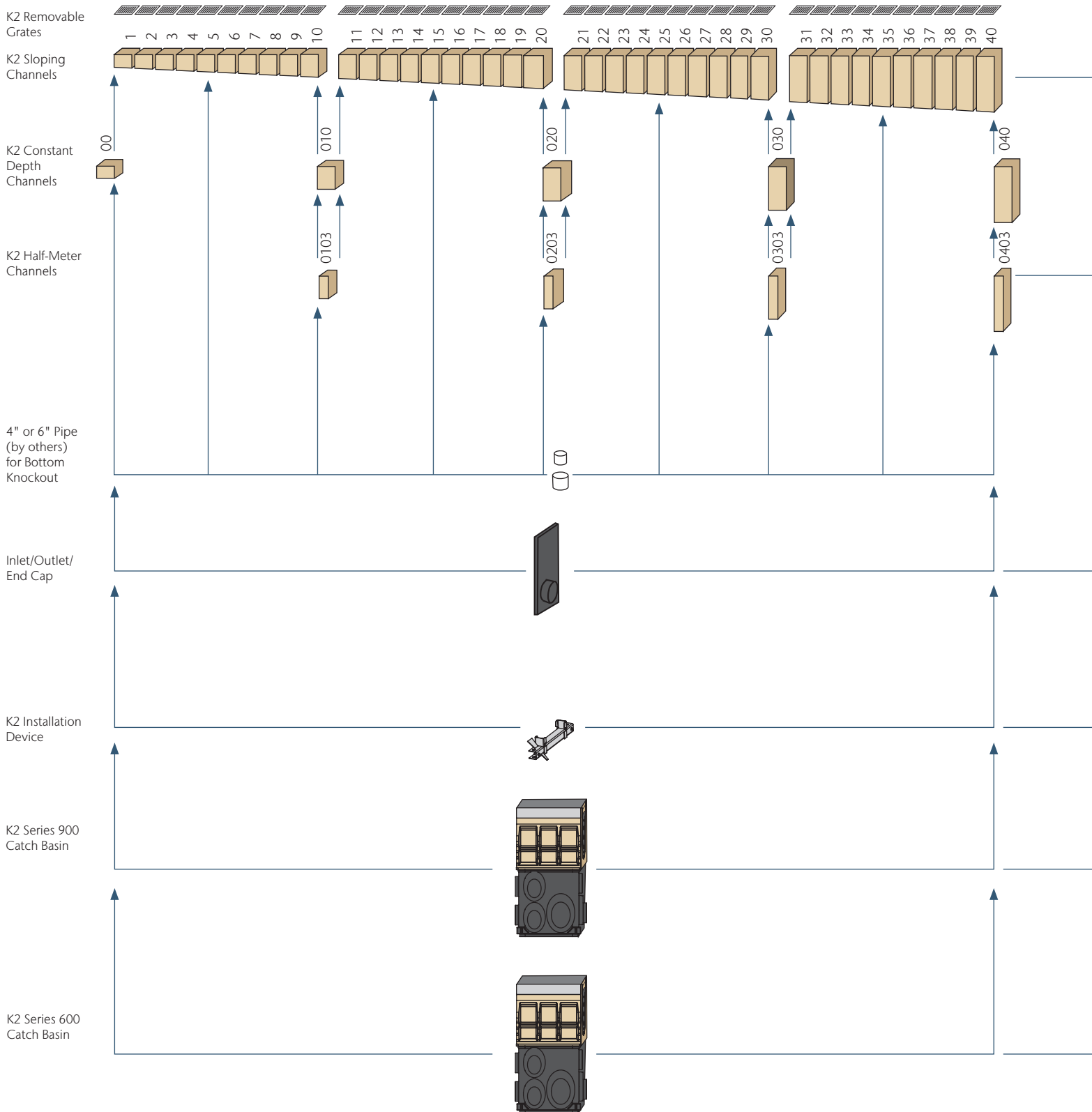

K2 Meter Channels - Sloping & Constant Depth



0.5% sloped channels in meter lengths and 40 depths which connect to create 40 meter (131'-2") continuously sloping run. Available with either galvanized or stainless steel edge rail.

Constant depth channels available in 5 depths. Can be used to create non-sloped runs, or inserted in sloped runs to increase length.

Bottom knockouts on all constant depths and 5, 10, 15, 20, 25, 30, 35, 40 channels.

K2 Half-meter Channels



Constant depth channels in 4 depths supplement meter channels. Side knockout and profiling enable side junction to be created. Bottom knockouts on all half meter channels. Available with either galvanized or stainless steel edge rail.

K2 Universal Inlet/Outlet/End Cap



Fits all channels and manufactured from ABS plastic to complement edge rail. Guides aid cutting to correct height. Wings clip cap onto end of channel. 4" and 6" bell end connection to SCH 40 pipe. Seal using PVC-ABS cement.

Note: ACO recommends removal of unused sections of bell end to ensure adequate pavement material coverage.

K2 Installation Device



Fits molded recesses on body of channel. Provides height and joint alignment - a sliding clamp locks the two channels together. Bolt to rebar on either side of channel to hold channels in place during concrete pour. Not reusable; it is encased within concrete pour.

K2 Series 900 In-Line Catch Basins



Two-part in-line catch basin with either a plastic base with 4", 6" and 8" drill-outs for pipe connection or a polymer concrete base. Supplied with plastic trash bucket. Options include an in-line or side foul air trap. Available with either galvanized or stainless steel edge rail.

Any channel can be connected into the catch basin by removing the end wall to the correct height with a box cutter. Cut-out guides provided for connection to channels 00, 010, 020, 030 and 040. All cut-outs to receive male channel ends. One blanking end plate supplied with in-line catch basin.

K2 Series 600 Catch Basins



Two-part in-line catch basin with either a plastic base with 4", 6" and 8" drill-outs for pipe connection or a polymer concrete base. Supplied with plastic trash bucket. Available with either galvanized or stainless steel edge rail.

Any channel can be connected to catch basin by removing end/side wall to correct height. Drill-outs guide connection to channels 00, 010, 020, 030 and 040. All cut-outs to receive male channel ends. Blanking kits included to stop concrete ingress during final pour.

Dimensions & Outlet Flow Rates

K2 Meter Channels

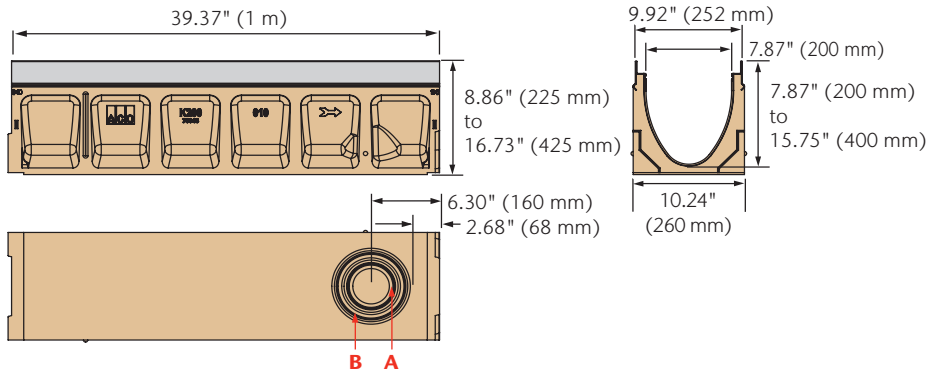

K2 Half-Meter Channels

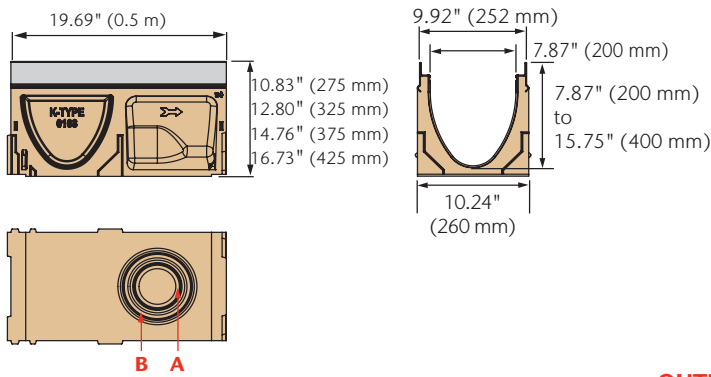

K2 Universal Inlet/Outlet/End Cap

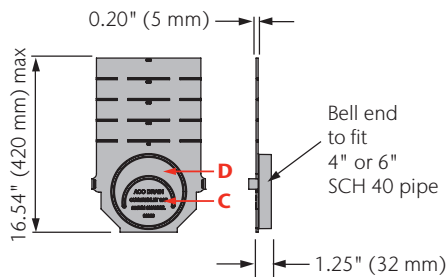

OUTLET FLOW RATES

Channel Outlet	Channel	Size (SCH 40)	Invert in	GPM	CFS
A	K2-00	4" round	7.87	153	0.34
	K2-40	4" round	15.75	216	0.48
B	K2-00	6" round	7.87	344	0.77
	K2-40	6" round	15.75	486	1.08
C	K2-20	4" round	7.87	132	0.29
	K2-40	4" round	15.75	202	0.45
D	K2-30	6" round	9.84	320	0.71
	K2-40	6" round	15.75	437	0.97

Note: These are pipe flow rates at specified outlet, NOT channel flow rates.

K2 Installation Device

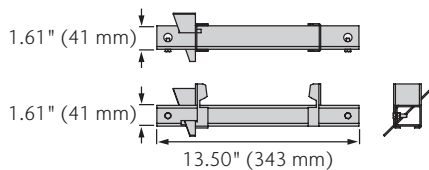

K200/KS200 Parts

	Part No.		Invert Depth				Overall Depth				Volume	Weight
	K200	KS200	in		mm		in		mm		gal	lbs
			female	male	female	male	female	male	female	male		
K2-00 Constant Depth Channel - 39.37" (1 m)*	75041	75441	7.87	7.87	200	200	8.86	8.86	225	225	7.54	83.6
K2-1 Sloped Channel - 39.37" (1 m)	75001	75401	7.87	8.07	200	205	8.86	9.06	225	230	7.94	83.6
K2-2 Sloped Channel - 39.37" (1 m)	75002	75402	8.07	8.27	205	210	9.06	9.25	230	235	8.13	84.7
K2-3 Sloped Channel - 39.37" (1 m)	75003	75403	8.27	8.46	210	215	9.25	9.45	235	240	8.33	85.8
K2-4 Sloped Channel - 39.37" (1 m)	75004	75404	8.46	8.66	215	220	9.45	9.65	240	245	8.53	86.9
K2-5 Sloped Channel - 39.37" (1 m)*	75005	75405	8.66	8.86	220	225	9.65	9.84	245	250	8.74	88.0
K2-6 Sloped Channel - 39.37" (1 m)	75006	75406	8.86	9.06	225	230	9.84	10.04	250	255	8.95	89.1
K2-7 Sloped Channel - 39.37" (1 m)	75007	75407	9.06	9.25	230	235	10.04	10.24	255	260	9.16	90.2
K2-8 Sloped Channel - 39.37" (1 m)	75008	75408	9.25	9.45	235	240	10.24	10.43	260	265	9.37	91.3
K2-9 Sloped Channel - 39.37" (1 m)	75009	75409	9.45	9.65	240	245	10.43	10.63	265	270	9.58	92.4
K2-10 Sloped Channel - 39.37" (1 m)*	75010	75410	9.65	9.84	245	250	10.63	10.83	270	275	9.79	93.5
K2-010 Constant Depth Channel - 39.37" (1 m)*	75043	75443	9.84	9.84	250	250	10.83	10.83	275	275	9.59	93.5
K2-0103 Constant Depth Channel - 19.69" (0.5 m)*	75044	75444	9.84	9.84	250	250	10.83	10.83	275	275	4.80	56.0
K2-11 Sloped Channel - 39.37" (1 m)	75011	75411	9.84	10.04	250	255	10.83	11.02	275	280	10.01	94.6
K2-12 Sloped Channel - 39.37" (1 m)	75012	75412	10.04	10.24	255	260	11.02	11.22	280	285	10.22	95.7
K2-13 Sloped Channel - 39.37" (1 m)	75013	75413	10.24	10.43	260	265	11.22	11.42	285	290	10.44	96.8
K2-14 Sloped Channel - 39.37" (1 m)	75014	75414	10.43	10.63	265	270	11.42	11.61	290	295	10.66	97.9
K2-15 Sloped Channel - 39.37" (1 m)*	75015	75415	10.63	10.83	270	275	11.61	11.81	295	300	10.88	99.0
K2-16 Sloped Channel - 39.37" (1 m)	75016	75416	10.83	11.02	275	280	11.81	12.01	300	305	11.10	100.1
K2-17 Sloped Channel - 39.37" (1 m)	75017	75417	11.02	11.22	280	285	12.01	12.20	305	310	11.32	101.2
K2-18 Sloped Channel - 39.37" (1 m)	75018	75418	11.22	11.42	285	290	12.20	12.40	310	315	11.54	102.3
K2-19 Sloped Channel - 39.37" (1 m)	75019	75419	11.42	11.61	290	295	12.40	12.60	315	320	11.76	103.4
K2-20 Sloped Channel - 39.37" (1 m)*	75020	75420	11.61	11.81	295	300	12.60	12.80	320	325	11.98	104.5
K2-020 Constant Depth Channel - 39.37" (1 m)*	75045	75445	11.81	11.81	300	300	12.80	12.80	325	325	11.78	104.5
K2-0203 Constant Depth Channel - 19.69" (0.5 m)*	75046	75446	11.81	11.81	300	300	12.80	12.80	325	325	5.89	64.0
K2-21 Sloped Channel - 39.37" (1 m)	75021	75421	11.81	12.01	300	305	12.80	12.99	325	330	12.21	105.6
K2-22 Sloped Channel - 39.37" (1 m)	75022	75422	12.01	12.20	305	310	12.99	13.19	330	335	12.42	106.7
K2-23 Sloped Channel - 39.37" (1 m)	75023	75423	12.20	12.40	310	315	13.19	13.39	335	340	12.65	107.8
K2-24 Sloped Channel - 39.37" (1 m)	75024	75424	12.40	12.60	315	320	13.39	13.58	340	345	12.87	108.9
K2-25 Sloped Channel - 39.37" (1 m)*	75025	75425	12.60	12.80	320	325	13.58	13.78	345	350	13.10	110.0
K2-26 Sloped Channel - 39.37" (1 m)	75026	75426	12.80	12.99	325	330	13.78	13.98	350	355	13.32	111.1
K2-27 Sloped Channel - 39.37" (1 m)	75027	75427	12.99	13.19	330	335	13.98	14.17	355	360	13.56	112.2
K2-28 Sloped Channel - 39.37" (1 m)	75028	75428	13.19	13.39	335	340	14.17	14.37	360	365	13.77	113.3
K2-29 Sloped Channel - 39.37" (1 m)	75029	75429	13.39	13.58	340	345	14.37	14.57	365	370	13.99	114.4
K2-30 Sloped Channel - 39.37" (1 m)*	75030	75430	13.58	13.78	345	350	14.57	14.76	370	375	14.22	115.5
K2-030 Constant Depth Channel - 39.37" (1 m)*	75047	75447	13.78	13.78	350	350	14.76	14.76	375	375	14.01	115.5
K2-0303 Constant Depth Channel - 19.69" (0.5 m)*	75048	75448	13.78	13.78	350	350	14.76	14.76	375	375	7.05	68.0
K2-31 Sloped Channel - 39.37" (1 m)	75031	75431	13.78	13.98	350	355	14.76	14.96	375	380	14.44	116.6
K2-32 Sloped Channel - 39.37" (1 m)	75032	75432	13.98	14.17	355	360	14.96	15.16	380	385	14.67	117.7
K2-33 Sloped Channel - 39.37" (1 m)	75033	75433	14.17	14.37	360	365	15.16	15.35	385	390	14.89	118.8
K2-34 Sloped Channel - 39.37" (1 m)	75034	75434	14.37	14.57	365	370	15.35	15.55	390	395	15.11	119.9
K2-35 Sloped Channel - 39.37" (1 m)*	75035	75435	14.57	14.76	370	375	15.55	15.75	395	400	15.34	121.0
K2-36 Sloped Channel - 39.37" (1 m)	75036	75436	14.76	14.96	375	380	15.75	15.94	400	405	15.56	122.1
K2-37 Sloped Channel - 39.37" (1 m)	75037	75437	14.96	15.16	380	385	15.94	16.14	405	410	15.78	123.2
K2-38 Sloped Channel - 39.37" (1 m)	75038	75438	15.16	15.35	385	390	16.14	16.34	410	415	16.02	124.3
K2-39 Sloped Channel - 39.37" (1 m)	75039	75439	15.35	15.55	390	395	16.34	16.54	415	420	16.23	125.4
K2-40 Sloped Channel - 39.37" (1 m)*	75040	75440	15.55	15.75	395	400	16.54	16.73	420	425	16.46	126.5
K2-040 Constant Depth Channel - 39.37" (1 m)*	75049	75449	15.75	15.75	400	400	16.73	16.73	425	425	16.27	126.5
K2-0403 Constant Depth Channel - 19.69" (0.5 m)*	75050	75450	15.75	15.75	400	400	16.73	16.73	425	425	8.14	77.0
K2 Universal Inlet/Outlet/End Cap		96821	15.75	15.75	400	400	16.54	16.54	420	420	-	1.4
K2 Debris Strainer for 4" Bottom Knockout ³		93488	-	-	-	-	-	-	-	-	-	0.2
K2 Installation Device		97478	-	-	-	-	-	-	-	-	-	4.0
Grate Removal Tool		01318	-	-	-	-	-	-	-	-	-	0.3
K2 QuickLok [®] Locking Bar		10457	-	-	-	-	-	-	-	-	-	0.5

Notes:

1. K200 has a galvanized steel edge rail for general use. KS200 has a grade 304 stainless steel edge rail for use where increased aesthetics or corrosion resistance is required.
2. KlassikDrain is sold as channel only. Choose appropriate grate from pages 55-56.
3. Debris strainer details for 4" dia. outlet on page 138.
4. See Catch Basin Parts List on page 49.

*This channel features 4" & 6" bottom knockouts.

Catch Basin Assemblies & Part Details

Polymer concrete catch basins can be used as standalone area drains or as the outlet to a trench run. They provide the highest hydraulic output and allow access to the pipe system for maintenance.

Series 900 catch basins are **in-line catch basins** (same width and visually indistinguishable from the trench run) while Series 600 catch basins are 12" wide, providing greater hydraulic output.

CATCH BASIN LOAD STRENGTH

Catch basins with plastic risers/bases should be used in load classes A–D. For heavy duty applications, ACO recommends using polymer concrete risers and catch basins for load class E/F applications.

K200/KS200 Catch Basin Parts

	Part No.		Volume*	Weight
	K200	KS200	gal	lbs
K2-902 In-Line Catch Basin w/ Plastic Base	94611	94612	18.1	68.0
K2-906 In-Line Catch Basin w/ Polymer Concrete Base	97937	97938	17.5	137.1
K2-621 Catch Basin w/ Plastic Base	94620	94621	24.9	91.0
K2-622 Catch Basin w/ Polymer Concrete Base	97917	97918	25.1	169.7
K2-631 Catch Basin w/ Plastic Riser & Base	94633	94634	34.7	101.0
K2-632 Catch Basin w/ Polymer Concrete Riser & Base	97927	97928	34.0	215.2
Series 600 Plastic Riser	99902		9.8	10.0
Series 611 Polymer Concrete Riser	91110		8.9	45.0
Foul Air Trap (fits all plastic basins)	90854		-	1.2

*Volume is up to grate seat and without trash bucket.

BLANKING END PLATES

Blanking plates are supplied with catch basin tops to stop concrete ingress at end of drain run. The plate is fitted by pushing it over the polymer concrete end bar to fit flush with side rails.



FOUL AIR TRAP

A plastic foul air trap that fits into the front or side of plastic in-line catch basins. A coupler is required to connect SCH 40 4" plain end pipe to underground pipe system.

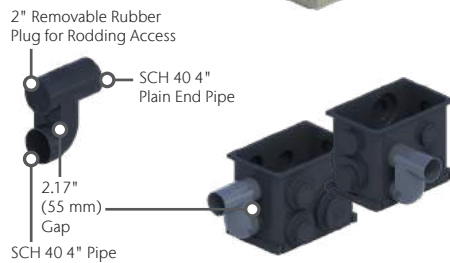

CATCH BASIN CHANNEL CONNECTION

Channels can be connected to catch basin on all four sides in a variety of configurations.

Series 900

Series 600

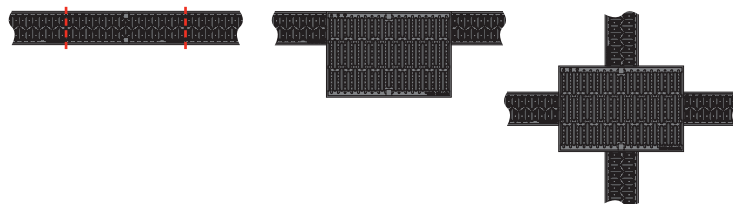

K2 SERIES 900 8" WIDE IN-LINE CATCH BASINS

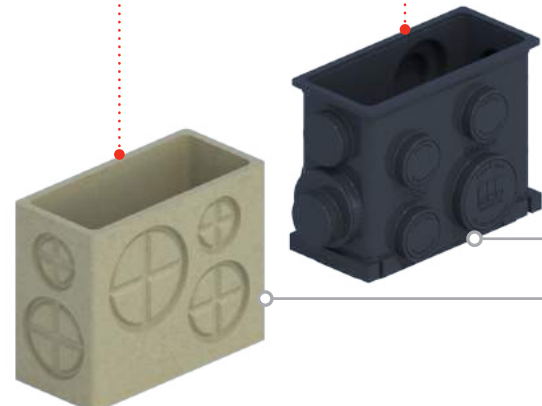
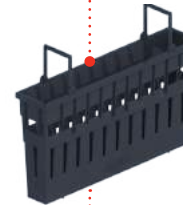
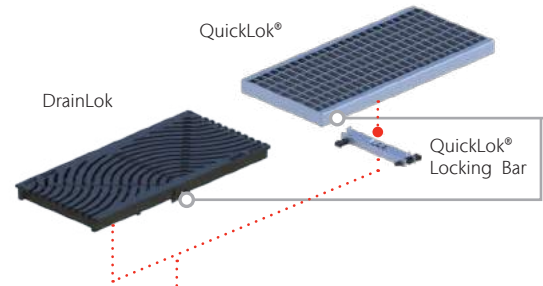

**K2 SERIES 600 12" WIDE
CATCH BASINS**

Series 600 Grates - choice of grates to match/complement channel with DrainLok or QuickLok® boltless locking. See page 77–78. All catch basin assemblies will include one QuickLok® Locking Bar.

Series 900 Grates - choice of grates to match channel grates with DrainLok or QuickLok® boltless locking. See page 55–56. QuickLok® grates are often paired with removable QuickLok® locking bars for easy access to trash bucket and pipework. One is included in each catch basin assembly.

Top Section - polymer concrete with integrally cast-in galvanized or stainless steel frame. Guides aid connection of male channel ends at #10, 20, 30 and 40 depths. Other channels can be connected by removing wall to required height. Blanking kit supplied with all catch basins.

Trash Bucket - plastic trash bucket designed to collect debris washed from trench run. Supported in catch basin top to avoid creation of a vacuum and reduction in outflow. K2-631 and K2-632 use a deeper bucket with riser.

Riser - a plastic or polymer concrete riser, supplied with K2-631 and K2-632, designed to provide additional catch basin depth and hydraulic output. Guides on the plastic version enable cutting to size at 2" (50 mm) intervals - minimum 2" and maximum 12" height. Additional units can be used (a maximum of 2 is recommended to ensure snake access is maintained and for structural stability).

Multiple risers can be used with series 600 catch basins.



Base - Plastic or polymer concrete base available. Plastic bases have a wide range of SCH 40 4", 6" and 8" cut-outs for easy pipe connection. Cut outs on end and side allow connection of ACO foul air trap. Polymer concrete bases have drill-outs cast on sides for pipe connections.



Catch Basin Dimensions & Outlet Flow Rates

K2-902G/S In-Line Catch Basin

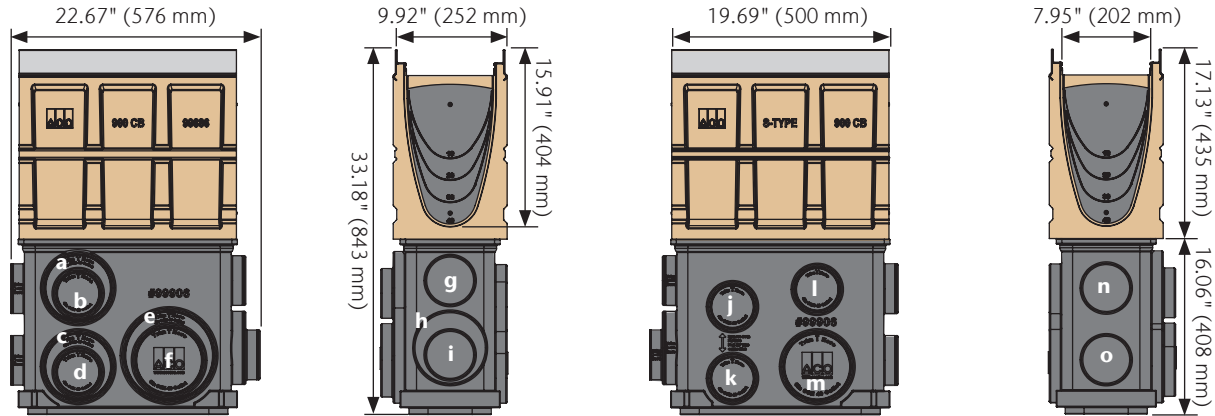

Catch Basin Outlet	Size (SCH 40)	Invert in	GPM	CFS
a	6"	24.68	570	1.27
b	4"	24.13	256	0.57
c	6"	31.82	658	1.47
d	4"	31.26	294	0.66
e	8"	31.82	1149	2.56
f	6"	31.26	651	1.45

Catch Basin Outlet	Size (SCH 40)	Invert in	GPM	CFS
g	4"	23.19	251	0.56
h	6"	30.32	640	1.43
i	4"	29.90	288	0.64

Catch Basin Outlet	Size (SCH 40)	Invert in	GPM	CFS
j	4"	25.33	263	0.59
k	4"	31.83	297	0.66
l	4"	23.76	254	0.57
m	6"	31.83	658	1.47

Catch Basin Outlet	Size (SCH 40)	Invert in	GPM	CFS
n	4"	23.91	255	0.57
o	4"	30.40	290	0.65

K2-906G/S In-Line Catch Basin

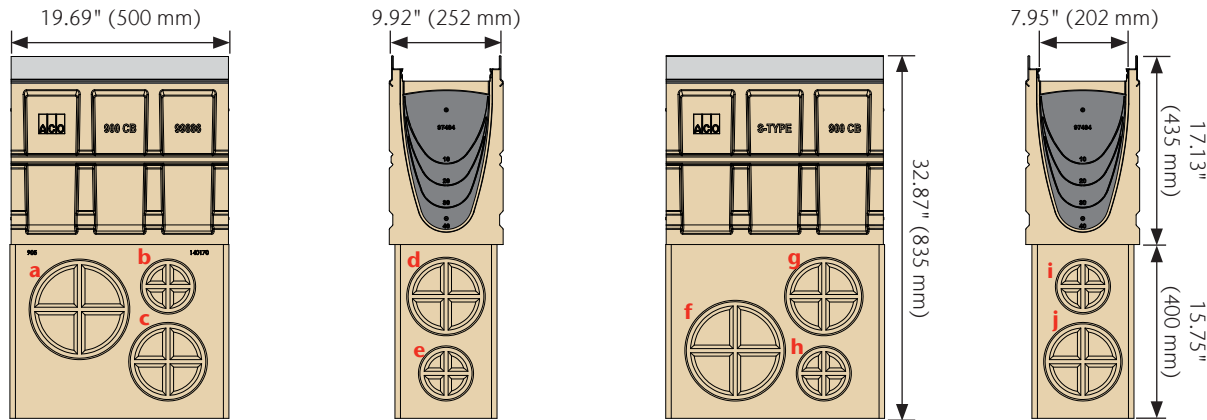

Catch Basin Outlet	Size (SCH 40)	Invert in	GPM	CFS
a	8"	27.05	1045	2.4
b	4"	22.98	249	0.57
c	6"	30.79	645	1.48

Catch Basin Outlet	Size (SCH 40)	Invert in	GPM	CFS
d	6"	24.89	573	1.32
e	4"	30.86	292	0.67

Catch Basin Outlet	Size (SCH 40)	Invert in	GPM	CFS
f	8"	30.79	1127	2.59
g	6"	24.89	573	1.32
h	4"	30.86	292	0.67

Catch Basin Outlet	Size (SCH 40)	Invert in	GPM	CFS
i	4"	22.98	249	0.57
j	6"	30.79	645	1.48

Note: These are pipe flow rates at specified outlets, NOT channel flow rates. Catch basin flow rates are listed without a trash bucket—using a trash bucket reduces flow.

K2-621G/S Catch Basin

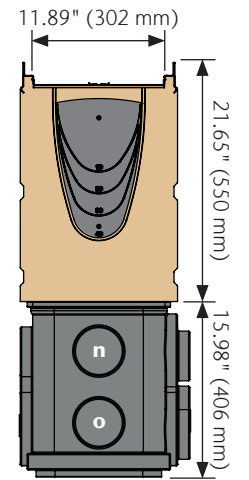
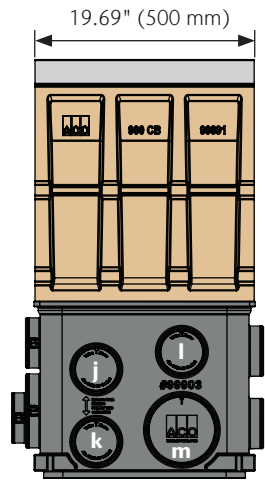
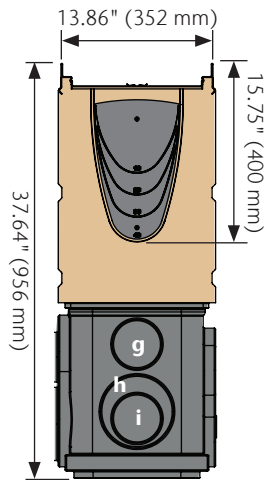
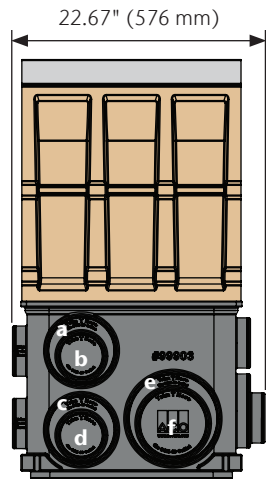

Catch Basin Outlet	Size (SCH 40)	Invert in	GPM	CFS
a	6"	29.15	626	1.40
b	4"	28.59	281	0.63
c	6"	36.28	707	1.57
d	4"	35.72	316	0.70
e	8"	36.28	1237	2.76
f	6"	35.72	701	1.56

Catch Basin Outlet	Size (SCH 40)	Invert in	GPM	CFS
g	4"	27.65	276	0.61
h	6"	34.78	690	1.54
i	4"	34.36	310	0.69

Catch Basin Outlet	Size (SCH 40)	Invert in	GPM	CFS
j	4"	29.80	287	0.64
k	4"	36.29	319	0.71
l	4"	28.22	279	0.62
m	6"	36.29	707	1.57

Catch Basin Outlet	Size (SCH 40)	Invert in	GPM	CFS
n	4"	28.37	280	0.62
o	4"	34.87	312	0.70

K2-622G/S Catch Basin

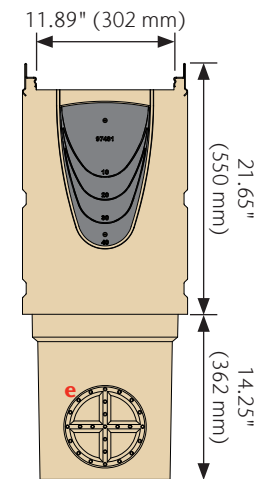
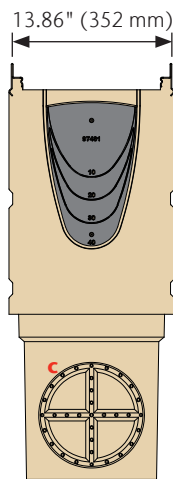
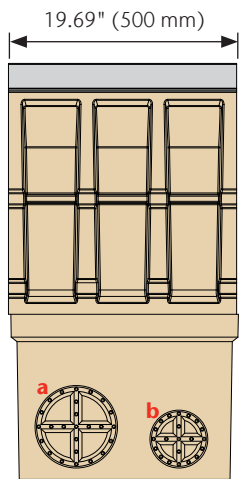

Catch Basin Outlet	Size (SCH 40)	Invert in	GPM	CFS
a	6"	25.95	587	1.35
b	4"	26.00	267	0.61

Catch Basin Outlet	Size (SCH 40)	Invert in	GPM	CFS
c	8"	25.95	1020	2.35

Catch Basin Outlet	Size (SCH 40)	Invert in	GPM	CFS
d	8"	25.95	1020	2.35

Catch Basin Outlet	Size (SCH 40)	Invert in	GPM	CFS
e	6"	25.95	587	1.35

Note: These are pipe flow rates at specified outlets, NOT channel flow rates. Catch basin flow rates are listed without a trash bucket—using a trash bucket reduces flow.

Underside

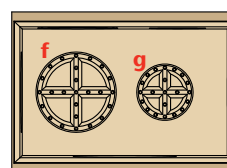

Catch Basin Outlet	Size (SCH 40)	Invert in	GPM	CFS
f	6"	35.90	734	1.69
g	4"	35.90	326	0.75

Catch Basin Dimensions & Outlet Flow Rates (cont.)

K2-631G/S Catch Basin

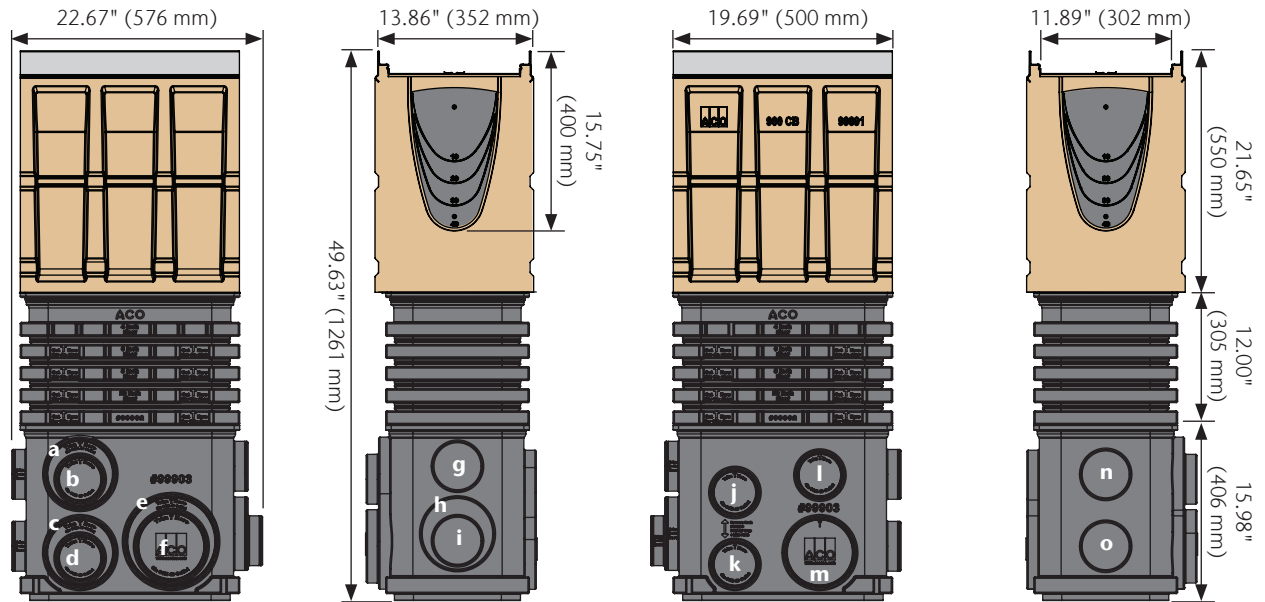

Catch Basin Outlet	Size (SCH 40)	Invert in	GPM	CFS
a	6"	41.15	757	1.69
b	4"	40.59	338	0.75
c	6"	48.28	824	1.84
d	4"	47.72	368	0.82
e	8"	48.28	1449	3.23
f	6"	47.72	819	1.83

Catch Basin Outlet	Size (SCH 40)	Invert in	GPM	CFS
g	4"	39.65	334	0.74
h	6"	46.78	810	1.81
i	4"	46.36	363	0.81

Catch Basin Outlet	Size (SCH 40)	Invert in	GPM	CFS
j	4"	41.80	343	0.77
k	4"	48.29	370	0.83
l	4"	40.22	337	0.75
m	6"	48.29	824	1.84

Catch Basin Outlet	Size (SCH 40)	Invert in	GPM	CFS
n	4"	40.37	337	0.75
o	4"	46.87	365	0.81

K2-632G/S Catch Basin

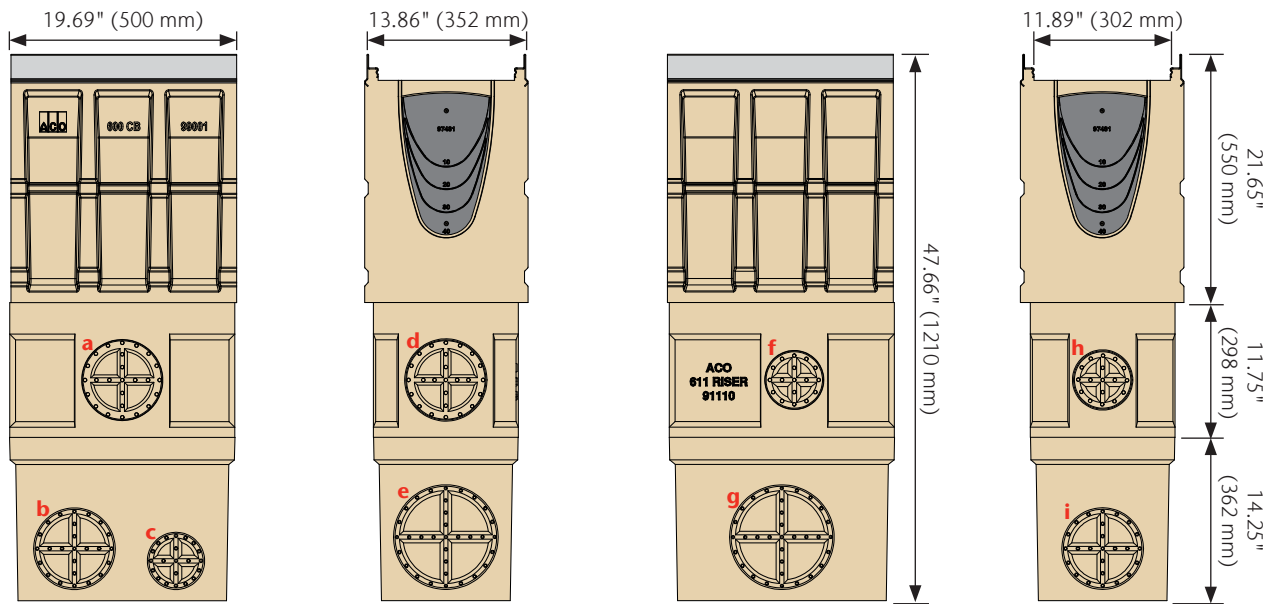

Catch Basin Outlet	Size (SCH 40)	Invert in	GPM	CFS
a	6"	31.40	652	1.45
b	6"	46.11	804	1.79
c	4"	46.17	362	0.81

Catch Basin Outlet	Size (SCH 40)	Invert in	GPM	CFS
d	6"	31.40	652	1.45
e	8"	46.10	1412	3.15

Catch Basin Outlet	Size (SCH 40)	Invert in	GPM	CFS
f	4"	30.40	290	0.65
g	8"	46.10	1412	3.15

Catch Basin Outlet	Size (SCH 40)	Invert in	GPM	CFS
h	4"	30.40	290	0.65
i	6"	46.10	804	1.79

Underside

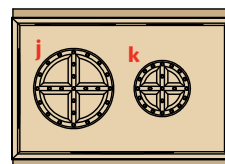

Catch Basin Outlet	Size (SCH 40)	Invert in	GPM	CFS
j	6"	47.65	845	1.94
k	4"	47.65	376	0.86

Note: These are pipe flow rates at specified outlets, NOT channel flow rates. Catch basin flow rates are listed without a trash bucket—using a trash bucket reduces flow.

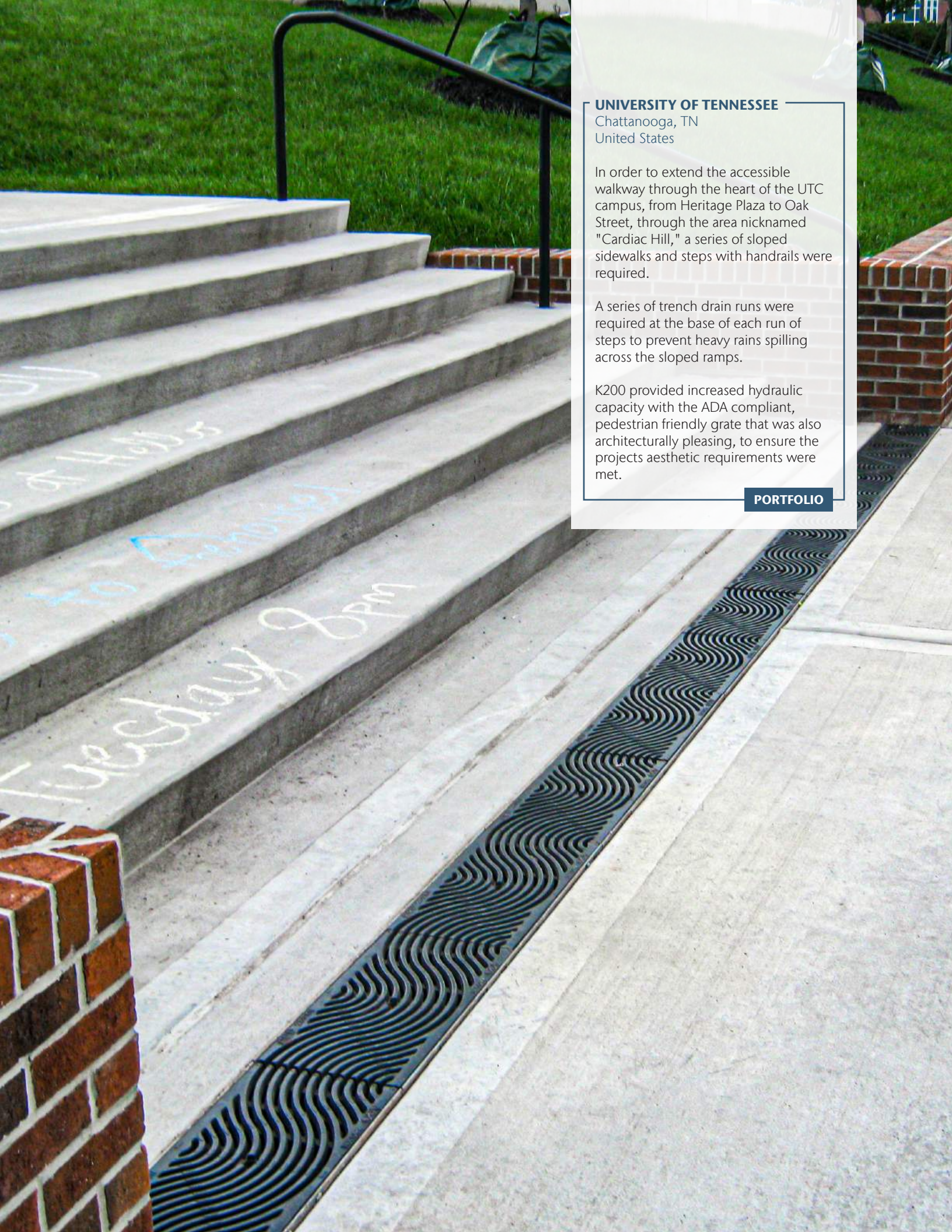

UNIVERSITY OF TENNESSEE

Chattanooga, TN
United States

In order to extend the accessible walkway through the heart of the UTC campus, from Heritage Plaza to Oak Street, through the area nicknamed "Cardiac Hill," a series of sloped sidewalks and steps with handrails were required.

A series of trench drain runs were required at the base of each run of steps to prevent heavy rains spilling across the sloped ramps.

K200 provided increased hydraulic capacity with the ADA compliant, pedestrian friendly grate that was also architecturally pleasing, to ensure the projects aesthetic requirements were met.

PORTFOLIO

K200/KS200 Grates - DrainLok

KEY



ADA Compliant
Compliant with Americans with Disabilities Act of 2010, Section 302.3 (page 174)



Heel-Resistant
ASME A112.6.3 - 2001 Heel-resistant slot width less than 0.31" (8 mm) (page 174)



Heel-Safe
Heel-safe slot width equal or less than 0.25" (6.5 mm) (page 174)



Slip-Resistant Grates
BPN over 24 (page 174)



Bicycle-Safe
Compliant to Australian Standard AS 3996 - 2006 (page 174)



Non-Metallic
No metallic/magnetic parts included (page 170)

For details on how psi is determined, see pages 161-166.

	Part No.	Length in (m)	Slot Size in	Intake Area in ²	Weight lbs					
LOAD CLASS B (EN 1433 - 125 KN) - 28,101 LBS - 387 PSI (LIGHT DUTY TRAFFIC)										
LONGITUDINAL STEEL¹										
	Type 647D - Stainless	142219	39.37 (1.0)	1.61 x 0.24	178.2	18.0	✓	✓	✓	✓
	Type 648D - Stainless	142220	19.69 (0.5)		89.1	9.0	✓	✓	✓	✓
LOAD CLASS C (EN 1433) - 56,202 LBS - 774 PSI (COMMERCIAL VEHICLE TRAFFIC)										
SLOTTED IRON⁴										
	Type 660D - Iron	142177	19.69 (0.5)	0.47 x 2.6	56.4	19.0	✗	✗	✗	✓
LONGITUDINAL IRON⁴										
	Type 676D - Iron	142173	19.69 (0.5)	2.07 x 0.24	35.8	19.0	✓	✓	✗	✓
WAVE IRON⁴										
	Type 680D - Iron	99579	19.69 (0.5)	0.27 x 0.9 avg.	58.1	27.0	✓	✓	✓	✗

Notes

1. Grade 304 stainless steel 2. Polypropylene material 3. Ductile iron to ASTM A536 Grade 65-45-12 4. Ductile iron to ASTM A536 Grade 80-55-06

DRAINLOK - BOLTLESS & BARLESS LOCKING SYSTEM



Factory-fitted locking device removes need for bolts and bars and improves channel hydraulic capacity. The DrainLok mechanism clips into channel edge rail for rapid installation. DrainLok grates are fit with an anti-shunt mechanism that restricts unwanted grate movement when installed, improving durability and longevity of the system.



1
Position grate onto channel and align anti-shunt detail with recess in rail.







2
Push down or stand on grate until it clicks into position.



3
To remove first grate, insert grate removal tool into slots at end of grate, pull up sharply. Remaining grates can be removed by hand.

K200/KS200 Grates - QuickLok®

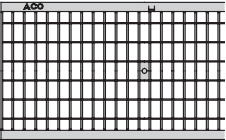
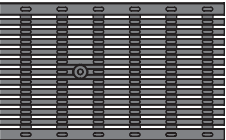
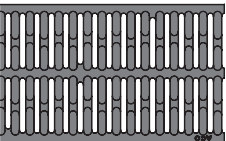
	Part No.	Length in (m)	Slot Size in	Intake		    					
				Area in ²	Weight lbs						
LOAD CLASS C (EN 1433 - 250 KN) - 56,202 LBS - 774 PSI (COMMERCIAL VEHICLE TRAFFIC)											
MESH STEEL											
	Type 605Q - Galvanized	10352	39.37 (1.0)	0.66 x 1.22	256.0	31.7					
	Type 606Q - Galvanized	10353	19.69 (0.5)		128.0	16.0	✓	✗	✗	✗	✓
	Type 630Q - Stainless ¹	16032	39.37 (1.0)		256.0	31.7					
	Type 631Q - Stainless ¹	16033	19.69 (0.5)		128.0	16.0					
LOAD CLASS E (EN 1433 - 600 KN) - 134,885 LBS - 1,856 PSI (INDUSTRIAL TRAFFIC)											
LONGITUDINAL IRON⁴											
	Type 678Q - Iron	138129	19.69 (0.5)	1.41 x 0.31	51.6	26.0	✓	✓	✓	✓	✓
SLOTTED IRON⁴											
	Type 661Q - Iron	10351	19.69 (0.5)	0.39 x 3.75	81.9	37.0	✓	✗	✗	✗	✗

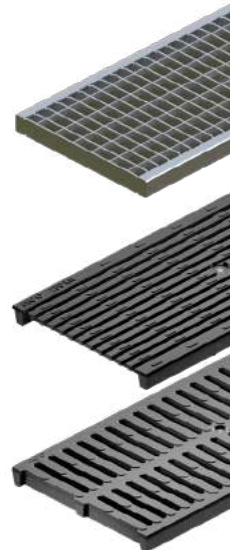

QUICKLOK® - BOLTLESS LOCKING SYSTEM

1		2		3		4		5		6	
	Fit locking bar		Fit grate		Remove grate						
	Locate locking bar in channel wall recesses by rotating clockwise.		Use hammer to tap bar into place, so that serrated ends grip in recess.		To install grate, align QuickLok® stud directly over locking bar.		Push down or stand on grate until it clicks into position.		To remove first grate, insert grate removal tool into slots at end of grate, pull up sharply. Remaining grates can be removed by hand.		To remove bar, remove clips then insert screwdriver into hole at end of bar and lever back serrated end, rotate bar free.

K200/KS200 Grates - Brickslot Tops

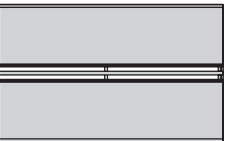
LOAD CLASS C (EN 1433 - 250 KN) - 56,202 LBS - 774 PSI (COMMERCIAL VEHICLE TRAFFIC)											
TWINSLOT 200 STEEL											
	Type 641 - Galvanized	138060	39.37 (1.0)	39.4 x 0.47	37.2	36.3					
	Type 642 - Galvanized	138061	19.69 (0.5)	19.7 x 0.47	18.6	18.7					
	Type 643 - Stainless ¹	138065	39.37 (1.0)	39.4 x 0.47	37.2	36.3	-	✓	✗	✗	✓
	Type 644 - Stainless ¹	138066	19.69 (0.5)	19.7 x 0.47	18.6	18.7					
HEEL-RESISTANT BRICKSLOT 200 STEEL											
	Type 670 - Galvanized	138070	39.37 (1.0)	39.4 x 0.30	24.8	28.2					
	Type 672 - Galvanized	138071	19.69 (0.5)	19.7 x 0.30	12.4	14.5					
	Type 673 - Stainless ¹	138075	39.37 (1.0)	39.4 x 0.30	24.8	28.2	-	✓	✓	✗	✓
	Type 674 - Stainless ¹	138076	19.69 (0.5)	19.7 x 0.30	12.4	14.5					

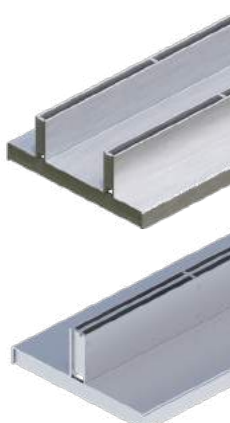



Brickslot 200

Discreet Slot & 8" Internal Width Drainage Channel

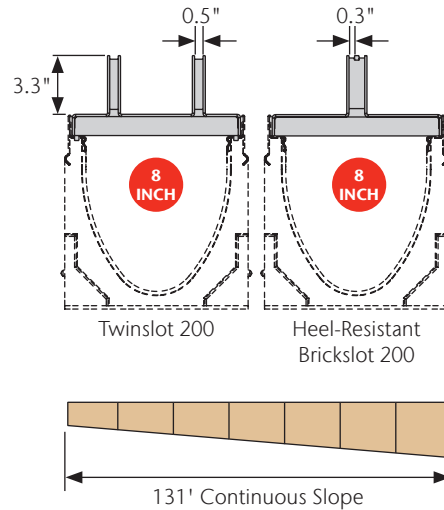
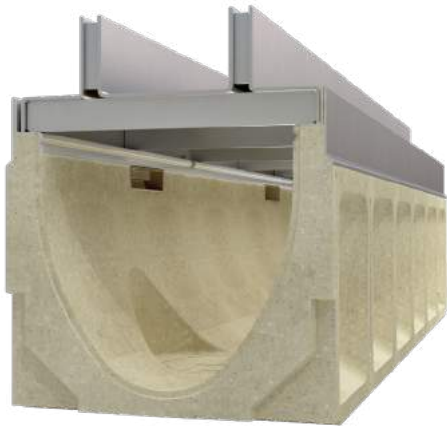

Brickslot is a discreet, galvanized steel drainage solution for use with 3.125" or less brick or stone pavers. The slot(s) blend in with the paving joints giving an aesthetic solution.





Brickslot 200 offers increased capacity via a double spaced Twinslot, or a central twin Heel-resistant slot.

Stainless steel Brickslot is the same system, but is manufactured entirely in grade 304 stainless steel. Stainless steel Brickslot should be used where increased aesthetics are desired, or where increased corrosion resistance is required.

Typical Applications:

- Pedestrian plazas
- Aesthetic areas
- Paved areas
- Sidewalks

BRICKSLOT 200 SELECTION CRITERIA

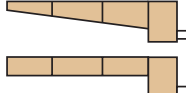
	Light to industrial duty loads
	Product can be used towards LEED & EPA requirements
	Resistant to many everyday chemicals
	Multiple grate options to meet legal requirements
	Increased hydraulic capacity
	Constant depth and/or sloped depth channels

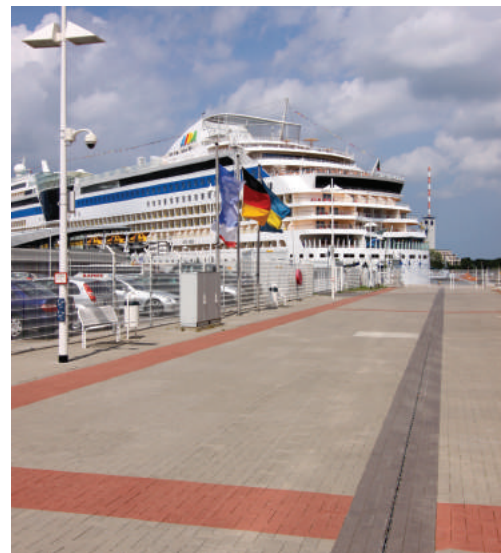

Brickslot 200 Features



Two 6" Parallel 0.5" (12 mm) Slots
 Easy-to-clean, smooth slots allow continuous water flow into the channel.

Brick Pavers
 Fit directly against slot. For light duty pedestrian applications, pavers can be set on sand; for heavier duty projects, pavers should be set on concrete. Maximum paver depth (allowing for 0.25" (6 mm) bedding material): 3.125" (80 mm).

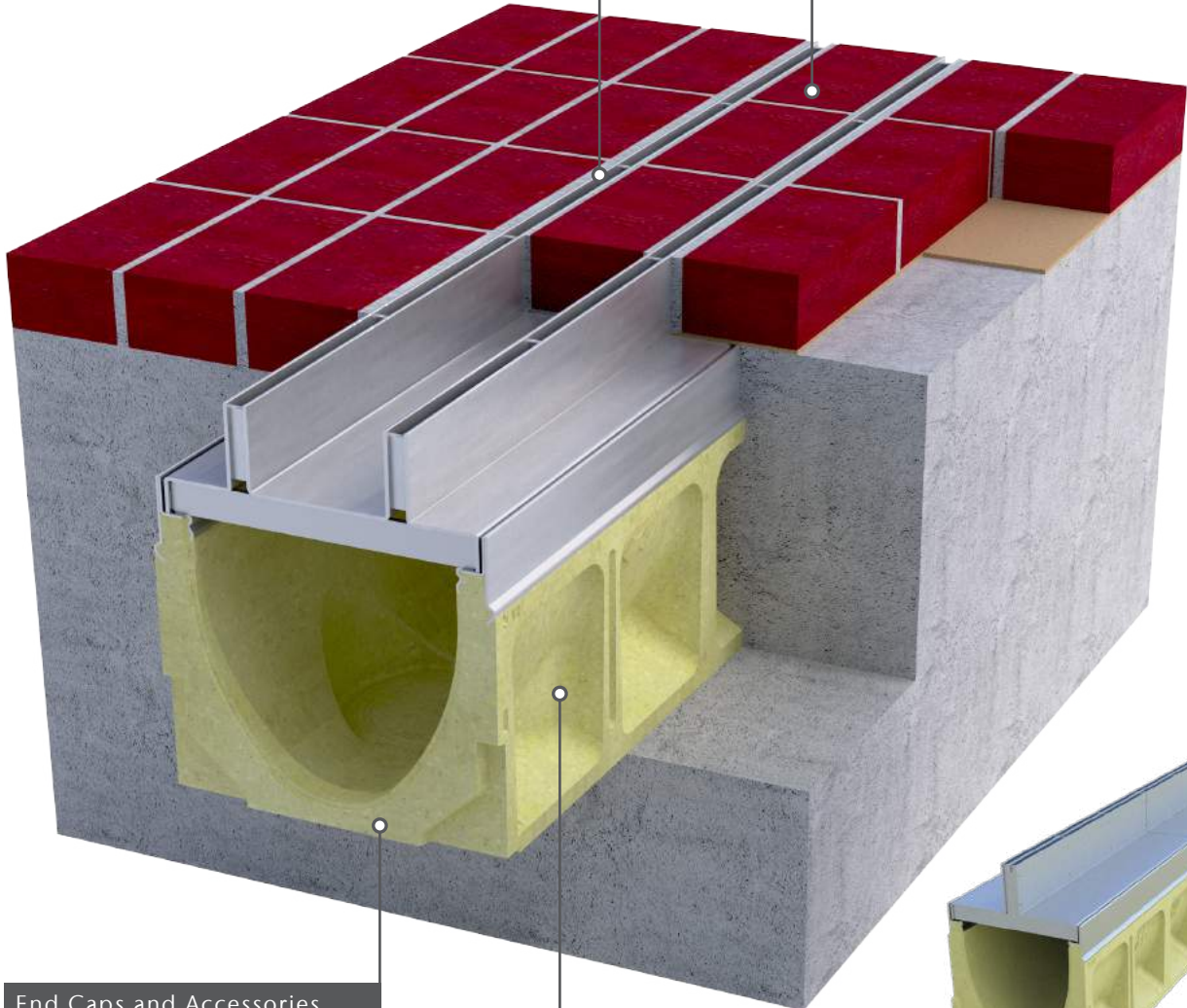



End Caps and Accessories
 Available from the K200 range. See page 48 for details.

Used with K200 Channel
 Brickslot fits directly into K200 channel grate recess. Half meter sections are available. Half meter access units provide access to channel or catch basin for maintenance. See page 48 for details.

Heel-Resistant Option
 Heel-Resistant Brickslot offers a double, 0.375" (8 mm) flared-opening slot to a 0.875" (22 mm) throat for increased drainage capacity.

Brickslot 200 Parts

	Part No.		Overall Depth in (mm)	Weight lbs	  
	Galvanized	Stainless			
Type 641/643 - Twinslot 200 - 39.37" (1 m)	138060	138065	4.45 (113)	36.3	✓ ✗ ✓
Type 642/644 - Twinslot 200 - 19.69" (0.5 m)	138061	138066	4.45 (113)	18.7	✓ ✗ ✓
Type 682/684 - Twinslot 200 Access Unit - 19.69" (0.5 m) ³	138062	138067	4.45 (113)	22.4	✓ ✗ ✓
Type 670/673 - Heel-Resistant Brickslot 200 - 39.37" (1 m)	138070	138075	4.45 (113)	28.2	✓ ✓ ✓
Type 672/674 - Heel-Resistant Brickslot 200 - 19.69" (0.5 m)	138071	138076	4.45 (113)	17.8	✓ ✓ ✓
Type 683/685 - Heel-Resistant Brickslot 200 Access Unit - 19.69" (0.5 m) ³	138072	138077	4.45 (113)	20.4	✓ ✓ ✓
Grate Removal Tool ⁴	01318		-	0.3	- - -

Notes

1. For K200 channels and K2-900 catch basin information see page 48-49.
2. Brickslot can also be used with SlabDrain H200K/S channels - see page 135.
3. Access unit can be used on channels or catch basins - for details please refer to separate Spec Info sheets.
4. Only access cover can be removed once Brickslot has been installed.
5. For custom slot widths, heights or materials (eg. 316L stainless steel), ask us about our Aquaduct product line.

Twinslot 200

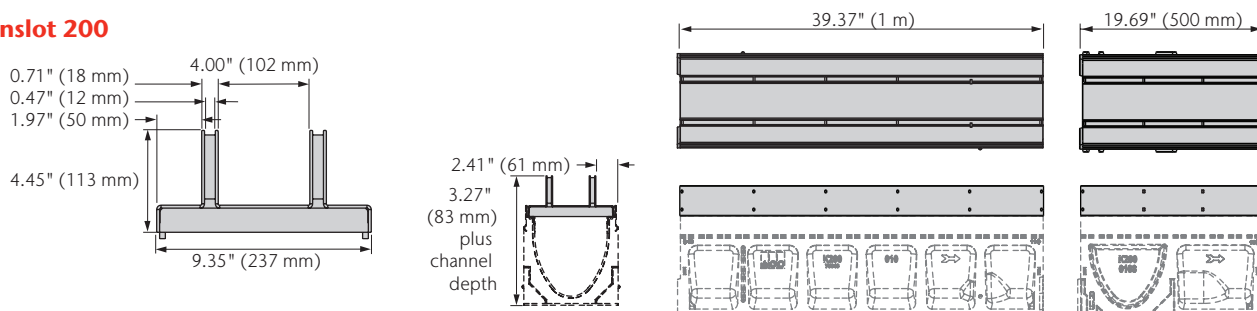

Heel-Resistant Brickslot 200

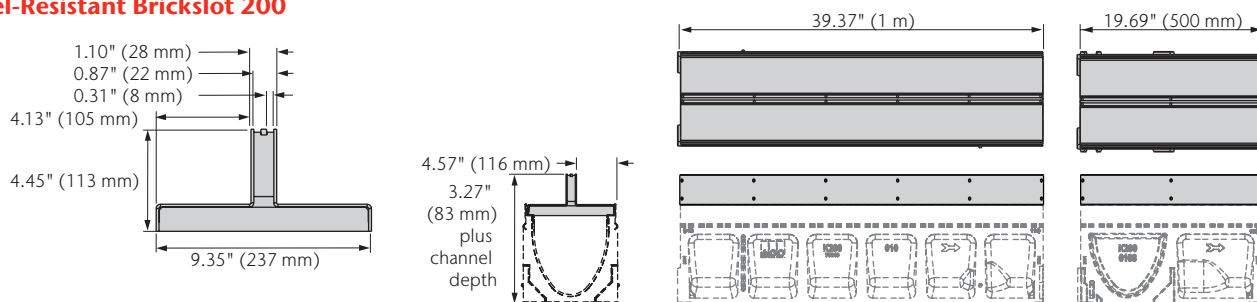

Twinslot 200 Access Unit

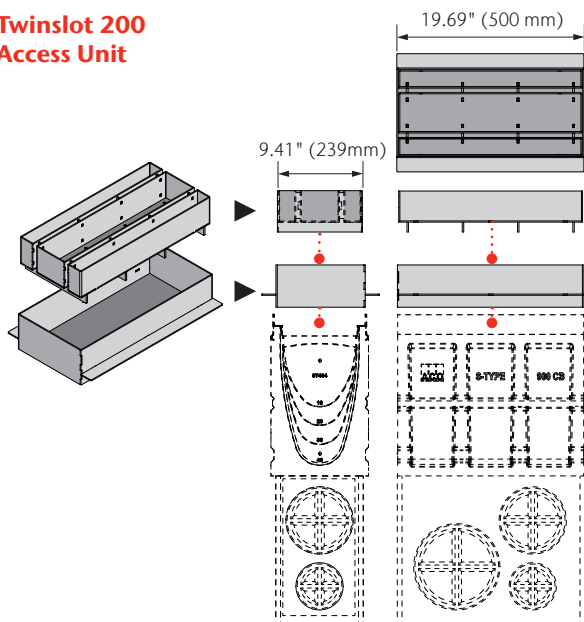

Heel-Resistant Brickslot 200 Access Unit

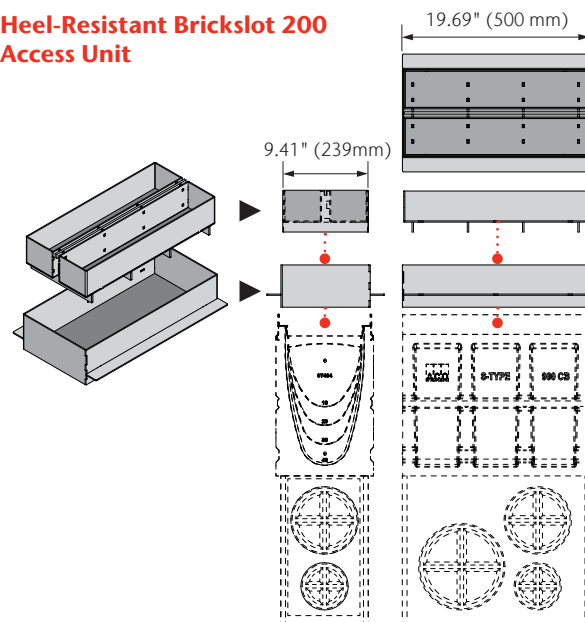



EcoPanel

Permeable Paver Cover & 8" Internal Width Drainage Channel

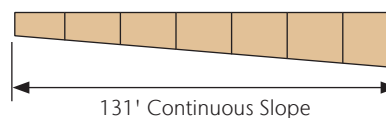
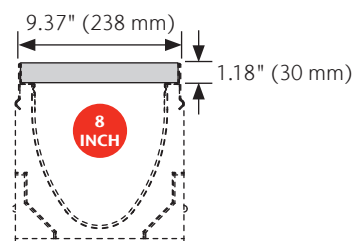

EcoPanel is a stormwater trench drain cover constructed from permeable UV stable resin-bonded aggregate in a galvanized steel frame. The unique combination of a durable load bearing surface enclosed in an engineered frame allows for water infiltration under medium duty traffic.













EcoPanel linear permeable paver covers are installed into ACO's KlassikDrain K200 or SlabDrain H200 (8" internal width) channels.

EcoPanel is a unique and decorative drainage solution that can be used as a design element to create distinctive urban landscapes.

Typical Applications:

- Shopping Centers/Malls
- Pedestrian Plazas
- Bicycle Paths
- Playgrounds
- Parking Lots
- Parks

ECOPANEL SELECTION CRITERIA

 	Pedestrian to light duty loads
	Product can be used towards LEED & EPA requirements
	Resistant to many everyday chemicals
  	Multiple grate options to meet legal requirements
  	Multiple grate options to meet design requirements
	Increased hydraulic capacity
 	Constant depth and/or sloped depth channels



EcoPanel Features



Access Unit - 39.37" (1 m)

With lifting key and keyhole.



Lifting Key
part no. 84306

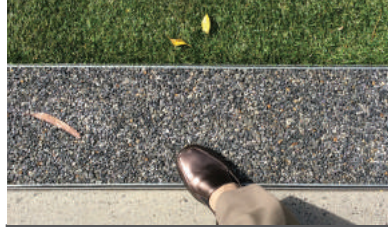

Pedestrian-Friendly

Up to Load Class B (28,101 lbs).
Suitable for pedestrian areas with slow moving commercial vehicles.

Standard Unit - 39.37" (1 m)

No lifting keyhole.

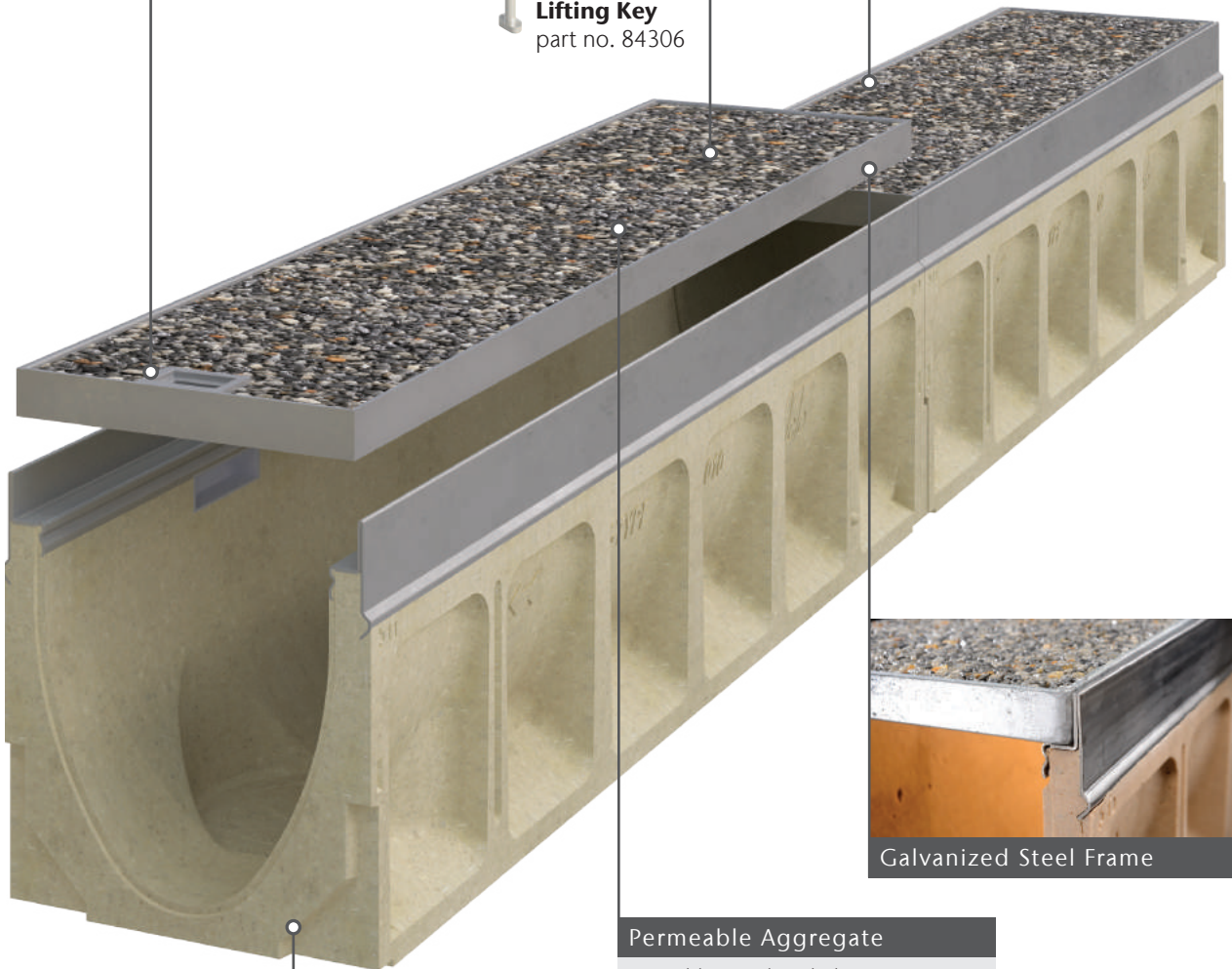

Galvanized Steel Frame

Permeable Aggregate

UV stable resin-bonded aggregate
available in eight colors.

K200 Channel

Constant depth or sloped.

EcoPanel Color and Material

		Part No.		Weight lbs
		Standard Unit	Access Unit	
	Black Granite	142742	142743	50.7
	Blue Marble	142744	142745	50.7
	Silver Marble	142746	142747	50.7
	Starlight Granite	142748	142749	50.7
	Sand Marble	142750	142751	50.7
	Gold Marble	142752	142753	50.7
	Gray Marble	142754	142755	50.7
	Red Granite	142756	142757	50.7



Porous Aggregate
Water permeates through the EcoPanel to the channel below.



Hydraulically Tested
Water Research Laboratory
at UNSW Sydney.

EcoPanel Standard Unit

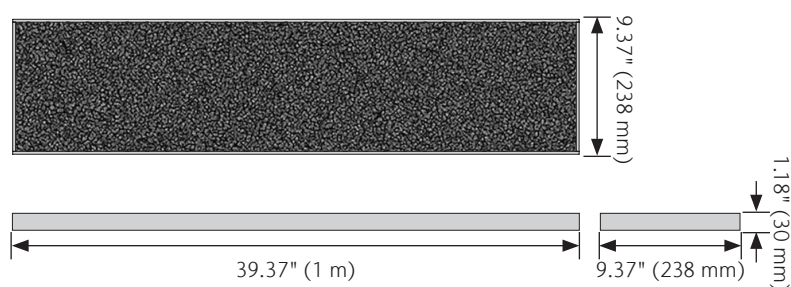

EcoPanel Connection Options

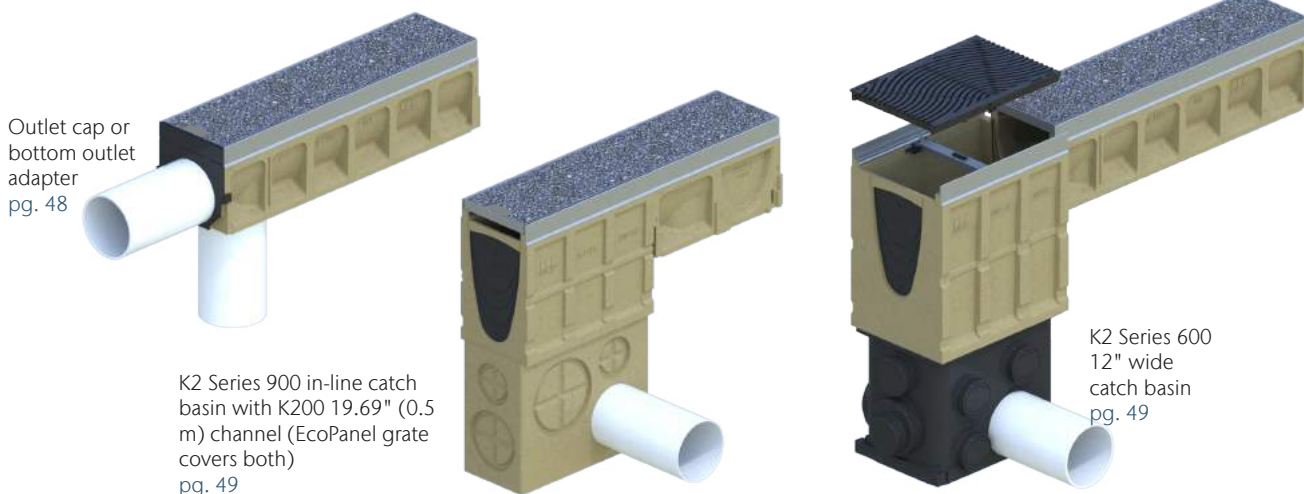



KlassikDrain K300/KS300

12" Internal Width General Purpose System

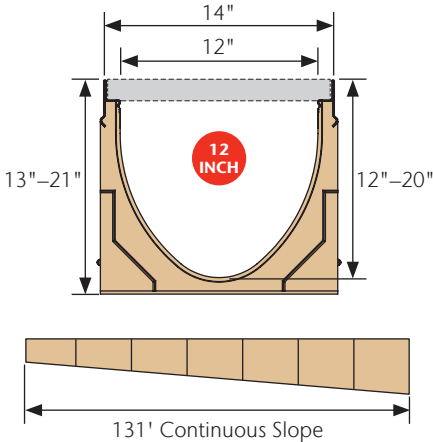
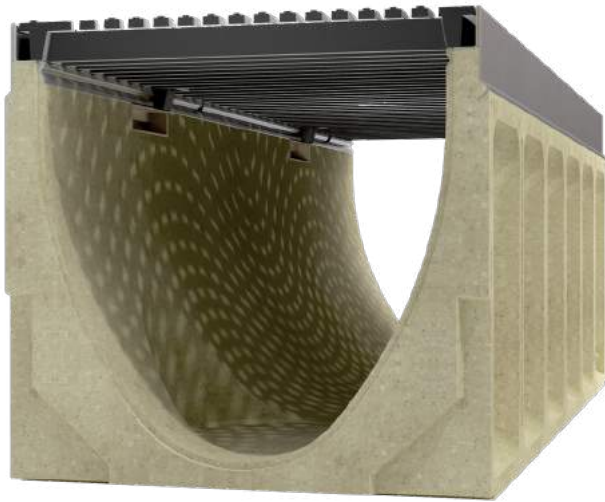

K300 is a 12" wide system with galvanized steel edge rail and wide choice of grates in different materials and slot styles up to Load Class E (60 ton) featuring either patented DrainLok or QuickLok® boltless locking systems.

KS300 is the same system, but the edge rail is grade 304 stainless steel. KS300 should be used where increased aesthetics are required, or where increased corrosion resistance is required.

Typical Applications:

- Parking lots & garages
- Shopping malls
- Pedestrian areas
- Light industrial areas
- Commercial areas
- Internal applications

KLASSIKDRAIN K300/KS300 SELECTION CRITERIA

		Light to industrial duty loads	
		Product can be used towards LEED & EPA requirements	
		Resistant to many everyday chemicals	
			Multiple grate options to meet legal requirements
			Multiple grate options to meet design requirements
		Maximum hydraulic capacity	
		Constant depth and/or sloped depth channels	



K300/KS300 System Layout

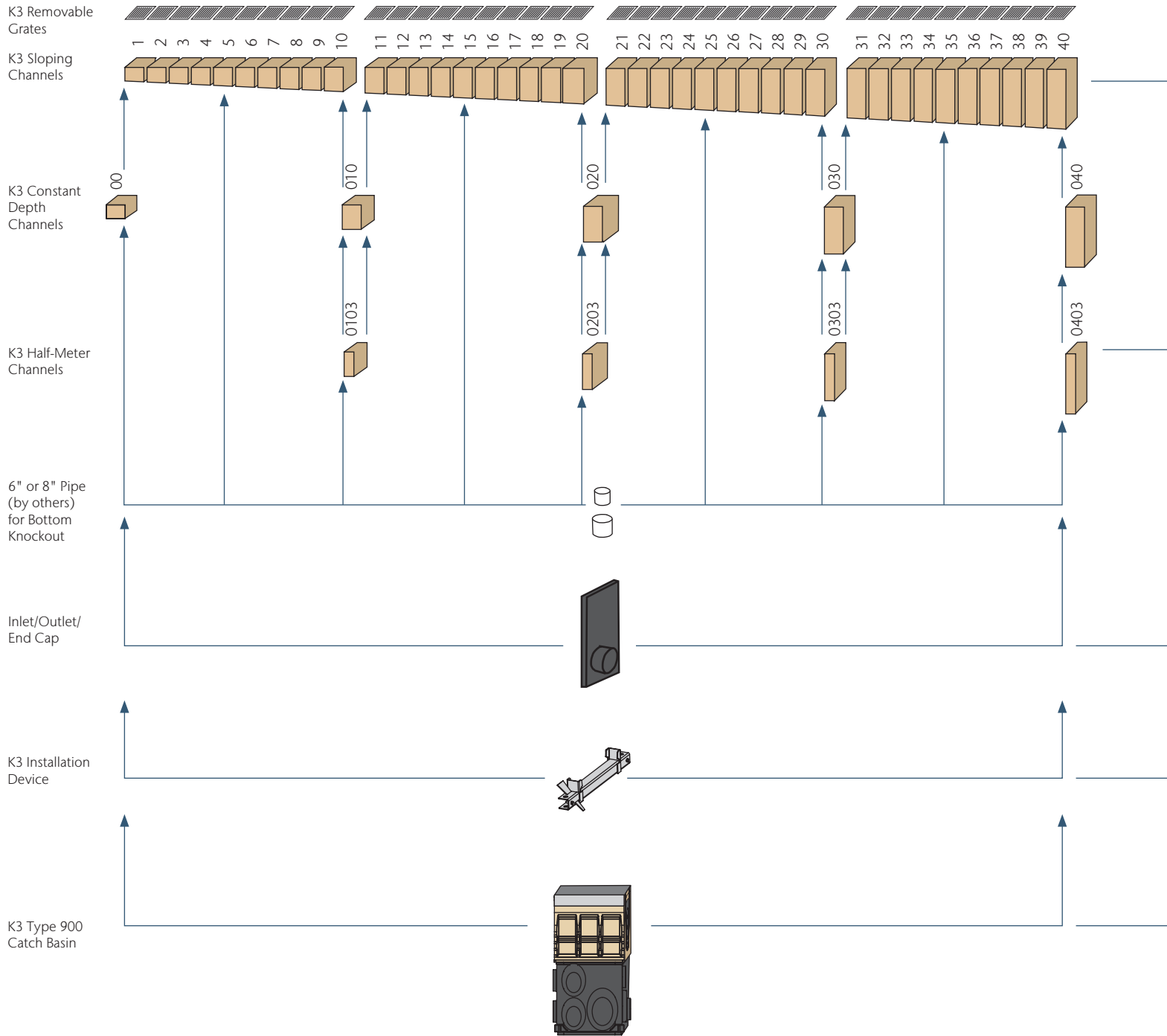



K3 Meter Channels - Sloping & Constant Depth

0.5% sloped channels in meter lengths and 40 depths which connect to create 40 meter (131'-2") continuously sloping run. Available with either galvanized or stainless steel edge rail.

Constant depth channels available in 5 depths. Can be used to create non-sloped runs, or inserted in sloped runs to increase length.

Bottom knockouts on all constant depths and 5, 10, 15, 20, 25, 30, 35, 40 channels.



K3 Half-Meter Channels

Constant depth channels in 4 depths supplement meter channels. Side knockout and profiling enable side junction to be created. Bottom knockouts on all half meter channels. Available with either galvanized or stainless steel edge rail.



K3 Universal Inlet/Outlet/End Cap

Fits all channels and manufactured from ABS plastic to complement edge rail. Guides aid cutting to correct height. Wings clip cap onto end of channel. 6", 8" and 10" bell end connection to SCH 40 pipe. Seal using PVC-ABS cement.



K3 Installation Device

Fits molded recesses on body of channel. Provides height and joint alignment - a sliding clamp locks the two channels together. Bolt to rebar on either side of channel to hold channels in place during concrete pour. Not reusable; it is encased within concrete pour.



K3 Series 900 In-Line Catch Basins

Two-part in-line catch basin with either a plastic base with 4", 6" and 8" drill-outs for pipe connection or a polymer concrete base. Supplied with plastic trash bucket. Options include an in-line or side foul air trap. Available with either galvanized or stainless steel edge rail.

Any channel can be connected into the catch basin by removing the end wall to the correct height with a box cutter. Cut-out guides provided for connection to channels 00, 010, 020, 030 and 040. All cut-outs to receive male channel ends. One blanking end plate supplied with in-line catch basin.

Dimensions & Outlet Flow Rates

K3 Meter Channels

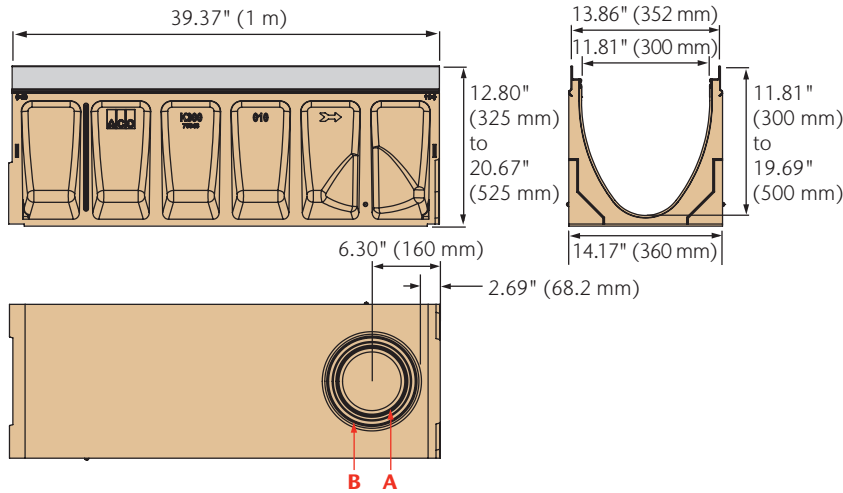

K3 Half-Meter Channels

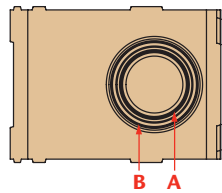
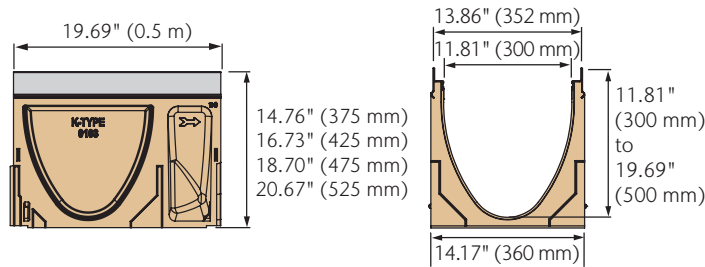

OUTLET FLOW RATES

Channel Outlet	Channel	Size (SCH 40)	Invert in	GPM	CFS
A	K3-00	6" round	11.81	421	0.94
	K3-40	6" round	19.69	544	1.21
B	K3-00	8" round	11.81	748	1.67
	K3-40	8" round	19.69	966	2.15
C	K3-00	6" round	11.81	364	0.81
	K3-40	6" round	19.69	500	1.11
D	K3-10	8" round	13.78	681	1.52
	K3-40	8" round	19.69	863	1.92
E	K3-20	10" round	15.75	1116	2.49
	K3-40	10" round	19.69	1304	2.91

Note: These are pipe flow rates at specified outlet, NOT channel flow rates.

K3 Universal Inlet/Outlet/End Cap

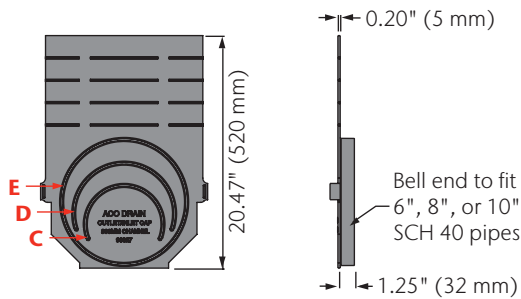

K3 Installation Device

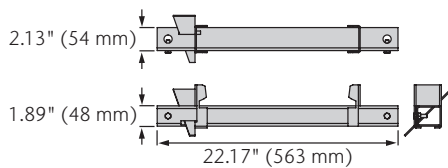

K300/KS300 Parts

	Part No.		Invert Depth				Overall Depth				Volume	Weight
	K300	KS300	in		mm		in		mm		gal	lbs
			female	male	female	male	female	male	female	male		
K3-00 - Constant Depth Channel - 39.37" (1 m)*	76041	76441	11.81	11.81	300	300	12.80	12.80	325	325	18.01	132.6
K3-1 Sloped Channel - 39.37" (1 m)	76001	76401	11.81	12.01	300	305	12.80	12.99	325	330	19.58	132.6
K3-2 Sloped Channel - 39.37" (1 m)	76002	76402	12.01	12.20	305	310	12.99	13.19	330	335	20.01	133.8
K3-3 Sloped Channel - 39.37" (1 m)	76003	76403	12.20	12.40	310	315	13.19	13.39	335	340	20.44	135.0
K3-4 Sloped Channel - 39.37" (1 m)	76004	76404	12.40	12.60	315	320	13.39	13.58	340	345	20.86	136.2
K3-5 Sloped Channel - 39.37" (1 m)*	76005	76405	12.60	12.80	320	325	13.58	13.78	345	350	21.28	137.4
K3-6 Sloped Channel - 39.37" (1 m)	76006	76406	12.80	12.99	325	330	13.78	13.98	350	355	21.69	138.6
K3-7 Sloped Channel - 39.37" (1 m)	76007	76407	12.99	13.19	330	335	13.98	14.17	355	360	22.11	139.8
K3-8 Sloped Channel - 39.37" (1 m)	76008	76408	13.19	13.39	335	340	14.17	14.37	360	365	22.51	141.0
K3-9 Sloped Channel - 39.37" (1 m)	76009	76409	13.39	13.58	340	345	14.37	14.57	365	370	22.92	142.2
K3-10 Sloped Channel - 39.37" (1 m)*	76010	76410	13.58	13.78	345	350	14.57	14.76	370	375	23.32	143.4
K3-010 Constant Depth Channel - 39.37" (1 m)*	76043	76443	13.78	13.78	350	350	14.76	14.76	375	375	21.22	143.4
K3-0103 Constant Depth Channel - 19.69" (0.5 m)*	76044	76444	13.78	13.78	350	350	14.76	14.76	375	375	10.61	75.3
K3-11 Sloped Channel - 39.37" (1 m)	76011	76411	13.78	13.98	350	355	14.76	14.96	375	380	23.72	144.6
K3-12 Sloped Channel - 39.37" (1 m)	76012	76412	13.98	14.17	355	360	14.96	15.16	380	385	24.11	145.8
K3-13 Sloped Channel - 39.37" (1 m)	76013	76413	14.17	14.37	360	365	15.16	15.35	385	390	24.51	147.0
K3-14 Sloped Channel - 39.37" (1 m)	76014	76414	14.37	14.57	365	370	15.35	15.55	390	395	24.89	148.2
K3-15 Sloped Channel - 39.37" (1 m)*	76015	76415	14.57	14.76	370	375	15.55	15.75	395	400	25.27	149.4
K3-16 Sloped Channel - 39.37" (1 m)	76016	76416	14.76	14.96	375	380	15.75	15.94	400	405	25.68	150.6
K3-17 Sloped Channel - 39.37" (1 m)	76017	76417	14.96	15.16	380	385	15.94	16.14	405	410	26.06	151.8
K3-18 Sloped Channel - 39.37" (1 m)	76018	76418	15.16	15.35	385	390	16.14	16.34	410	415	26.44	153.0
K3-19 Sloped Channel - 39.37" (1 m)	76019	76419	15.35	15.55	390	395	16.34	16.54	415	420	26.83	154.2
K3-20 Sloped Channel - 39.37" (1 m)*	76020	76420	15.55	15.75	395	400	16.54	4.92	420	125	27.21	155.4
K3-020 Constant Depth Channel - 39.37" (1 m)*	76045	76445	15.75	15.75	400	400	16.73	16.73	425	425	24.53	155.4
K3-0203 Constant Depth Channel - 19.69" (0.5 m)*	76046	76446	15.75	15.75	400	400	16.73	16.73	425	425	12.27	82.3
K3-21 Sloped Channel - 39.37" (1 m)	76021	76421	15.75	15.94	400	405	16.73	16.93	425	430	27.59	156.7
K3-22 Sloped Channel - 39.37" (1 m)	76022	76422	15.94	16.14	405	410	16.93	17.13	430	435	27.97	157.9
K3-23 Sloped Channel - 39.37" (1 m)	76023	76423	16.14	16.34	410	415	17.13	17.32	435	440	28.34	159.1
K3-24 Sloped Channel - 39.37" (1 m)	76024	76424	16.34	16.54	415	420	17.32	17.52	440	445	28.72	160.3
K3-25 Sloped Channel - 39.37" (1 m)*	76025	76425	16.54	16.73	420	425	17.52	17.72	445	450	29.09	161.5
K3-26 Sloped Channel - 39.37" (1 m)	76026	76426	16.73	16.93	425	430	17.72	17.91	450	455	29.47	162.7
K3-27 Sloped Channel - 39.37" (1 m)	76027	76427	16.93	17.13	430	435	17.91	18.11	455	460	29.84	163.9
K3-28 Sloped Channel - 39.37" (1 m)	76028	76428	17.13	17.32	435	440	18.11	18.31	460	465	30.21	165.1
K3-29 Sloped Channel - 39.37" (1 m)	76029	76429	17.32	17.52	440	445	18.31	18.50	465	470	30.58	166.3
K3-30 Sloped Channel - 39.37" (1 m)*	76030	76430	17.52	17.72	445	450	18.50	18.70	470	475	30.95	167.5
K3-030 Constant Depth Channel - 39.37" (1 m)*	76047	76447	17.72	17.72	450	450	18.70	18.70	475	475	27.87	167.5
K3-0303 Constant Depth Channel - 19.69" (0.5 m)*	76048	76448	17.72	17.72	450	450	18.70	18.70	475	475	13.94	89.5
K3-31 Sloped Channel - 39.37" (1 m)	76031	76431	17.72	17.91	450	455	18.70	18.90	475	480	31.32	168.7
K3-32 Sloped Channel - 39.37" (1 m)	76032	76432	17.91	18.11	455	460	18.90	19.09	480	485	31.69	169.9
K3-33 Sloped Channel - 39.37" (1 m)	76033	76433	18.11	18.31	460	465	19.09	19.29	485	490	32.06	171.1
K3-34 Sloped Channel - 39.37" (1 m)	76034	76434	18.31	18.50	465	470	19.29	19.49	490	495	32.42	172.3
K3-35 Sloped Channel - 39.37" (1 m)*	76035	76435	18.50	18.70	470	475	19.49	19.69	495	500	32.79	173.5
K3-36 Sloped Channel - 39.37" (1 m)	76036	76436	18.70	18.90	475	480	19.69	19.88	500	505	33.16	174.7
K3-37 Sloped Channel - 39.37" (1 m)	76037	76437	18.90	19.09	480	485	19.88	20.08	505	510	33.52	175.9
K3-38 Sloped Channel - 39.37" (1 m)	76038	76438	19.09	19.29	485	490	20.08	20.28	510	515	33.88	177.1
K3-39 Sloped Channel - 39.37" (1 m)	76039	76439	19.29	19.49	490	495	20.28	20.47	515	520	34.25	178.3
K3-40 Sloped Channel - 39.37" (1 m)*	76040	76440	19.49	19.69	495	500	20.47	20.67	520	525	34.61	179.5
K3-040 Constant Depth Channel - 39.37" (1 m)*	76049	76449	19.69	19.69	500	500	20.67	20.67	525	525	31.25	179.5
K3-0403 Constant Depth Channel - 19.69" (0.5 m)*	76050	76450	19.69	19.69	500	500	20.67	20.67	525	525	15.63	97.7
K3 Universal Inlet/Outlet/End Cap	96826		19.69	19.69	500	500	20.47	20.47	520	520	-	2.5
K3 Installation Device	97479		-	-	-	-	-	-	-	-	-	4.9
Grate Removal Tool	01318		-	-	-	-	-	-	-	-	-	0.3
QuickLok® Locking Bar	10458		-	-	-	-	-	-	-	-	-	0.7

Notes:

1. K300 has a galvanized steel edge rail for general use. KS300 has a grade 304 stainless steel edge rail for use where increased aesthetics or corrosion resistance is required.
2. KlassikDrain is sold as channel only. Choose appropriate grate from pages 77-78.
3. See Catch Basin Parts List on page 71.

*This channel features 6" & 8" bottom knockouts.

Catch Basin Assemblies & Part Details

Polymer concrete catch basins can be used as standalone area drains or as the outlet to a trench run. They provide the highest hydraulic output and allow access to the pipe system for maintenance.

Series 900 catch basins are **in-line catch basins** (same width and visually indistinguishable from the trench run).

CATCH BASIN LOAD STRENGTH

Catch basins with plastic risers/bases should be used in load classes A–D. For heavy duty applications, ACO recommends using polymer concrete risers and catch basins for load class E/F applications.

K300/KS300 Catch Basin Parts

	Part No.		Volume* gal	Weight lbs
	K300	KS300		
K3-903 In-Line Catch Basin w/ Plastic Base	94614	94615	30.4	88.0
K3-907 In-Line Catch Basin w/ Polymer Concrete Base	97919	97920	32.7	147.3
K3-904 In-Line Catch Basin w/ Plastic Riser & Base	94635	94636	40.2	98.0
K3-908 In-Line Catch Basin w/ Polymer Concrete Riser & Base	97929	97930	41.6	192.3
Series 600 Plastic Riser	99902		9.8	10.0
Series 611 Polymer Concrete Riser	91110		8.9	45.0
Foul Air Trap (fits all plastic basins)	90854		-	1.2

*Volume is up to grate seat and without trash bucket.

BLANKING END PLATES

Blanking plates are supplied with catch basin tops to stop concrete ingress at end of drain run. The plate is fitted by pushing it over the polymer concrete end bar to fit flush with side rails.



FOUL AIR TRAP

A plastic foul air trap that fits into the front or side of plastic in-line catch basins. A coupler is required to connect SCH 40 4" plain end pipe to underground pipe system.

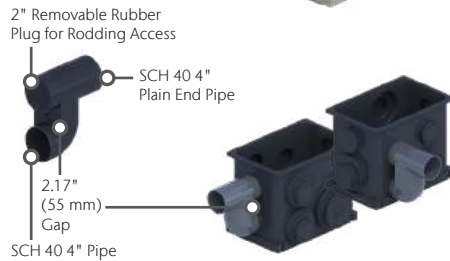

CATCH BASIN CHANNEL CONNECTION

Channels can be connected to catch basin on all four sides in a variety of configurations.

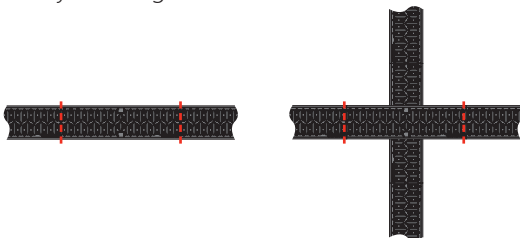

Series 900 Grates - choice of grates to match channel grates with DrainLok or QuickLok® boltless locking. See page 77–78. QuickLok® grates are often paired with removable QuickLok® locking bars for easy access to trash bucket and pipework. One is included in each catch basin assembly.

Top Section - polymer concrete with integrally cast-in galvanized or stainless steel frame. Guides aid connection of male channel ends at #10, 20, 30 and 40 depths. Other channels can be connected by removing wall to required height. Blanking kit supplied with all catch basin options.

Trash Bucket - plastic trash bucket designed to collect debris washed from trench run. Supported in catch basin top to avoid creation of a vacuum and reduction in outflow. K3-904 and K3-908 use a deeper bucket with riser.

Riser - a plastic or polymer concrete riser, supplied with K3-904 and K3-908, designed to provide additional catch basin depth and hydraulic output. Guides on the plastic version enable cutting to size at 2" (50 mm) intervals - minimum 2" and maximum 12" height. Additional units can be used (a maximum of 2 is recommended to ensure snake access is maintained and for structural stability).

Multiple risers can be used.



Base - Plastic or polymer concrete base available. Plastic bases have a range of SCH 40 4", 6" and 8" cut-outs for easy pipe connection. Cut-outs on end and side allow connection of ACO foul air trap. Polymer concrete bases have drill-outs cast on sides for pipe connections.

K3 SERIES 900 12" WIDE IN-LINE CATCH BASINS

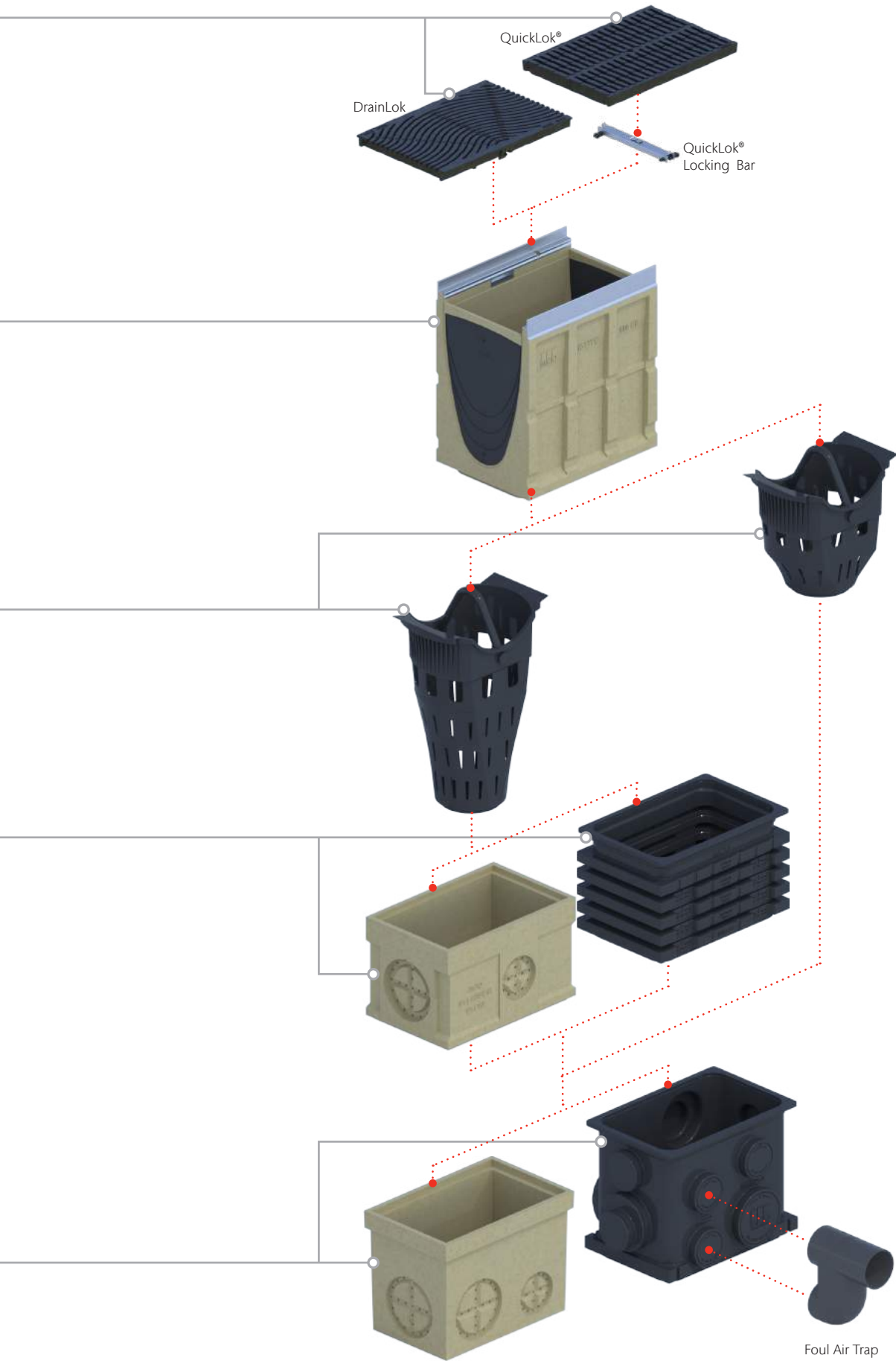

Catch Basin Dimensions & Outlet Flow Rates

K3-903G/S In-Line Catch Basin

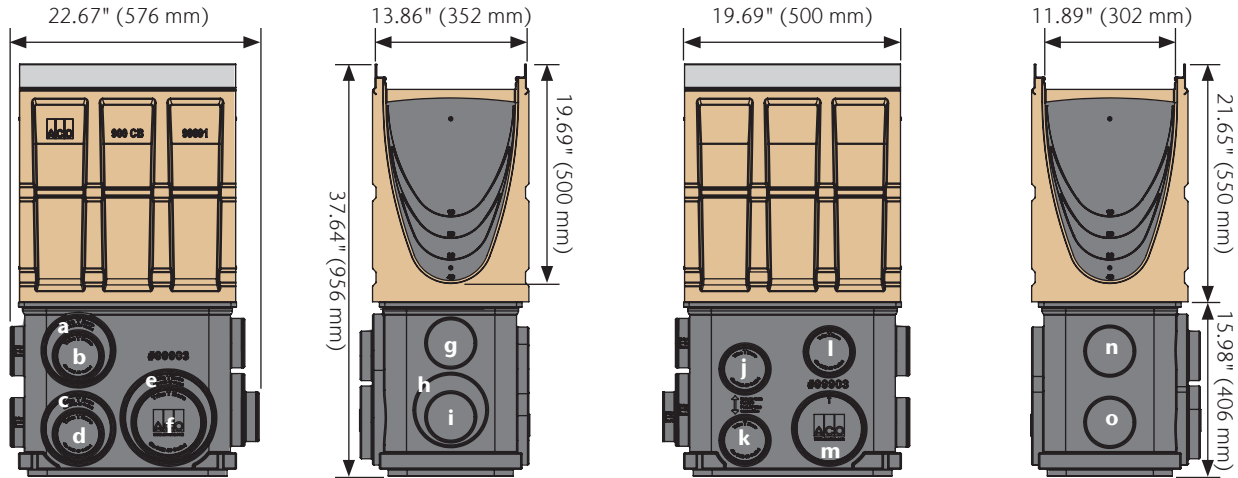

Catch Basin Outlet	Size (SCH 40)	Invert in	GPM	CFS
a	6"	29.15	626	1.40
b	4"	28.59	281	0.63
c	6"	36.28	707	1.57
d	4"	35.72	316	0.70
e	8"	36.28	1237	2.76
f	6"	35.72	701	1.56

Catch Basin Outlet	Size (SCH 40)	Invert in	GPM	CFS
g	4"	27.65	276	0.61
h	6"	34.78	690	1.54
i	4"	34.36	310	0.69

Catch Basin Outlet	Size (SCH 40)	Invert in	GPM	CFS
j	4"	29.80	287	0.64
k	4"	36.29	319	0.71
l	4"	28.22	279	0.62
m	6"	36.29	707	1.57

Catch Basin Outlet	Size (SCH 40)	Invert in	GPM	CFS
n	4"	28.37	280	0.62
o	4"	34.87	312	0.70

K3-907G/S In-Line Catch Basin

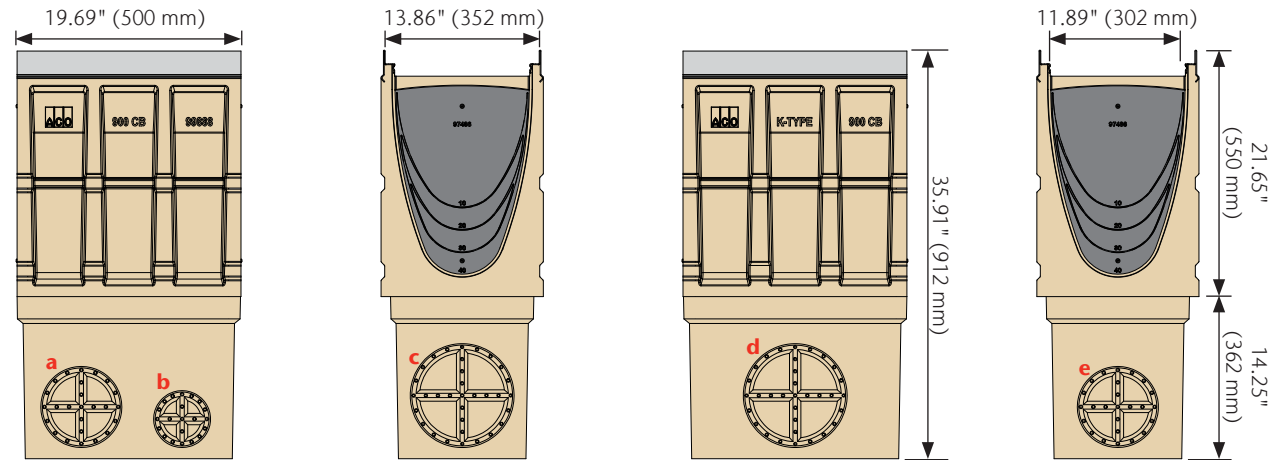

Catch Basin Outlet	Size (SCH 40)	Invert in	GPM	CFS
a	6"	34.35	686	1.53
b	4"	34.32	310	0.69

Catch Basin Outlet	Size (SCH 40)	Invert in	GPM	CFS
c	8"	34.35	1199	2.67

Catch Basin Outlet	Size (SCH 40)	Invert in	GPM	CFS
d	8"	34.35	1199	2.67

Catch Basin Outlet	Size (SCH 40)	Invert in	GPM	CFS
e	6"	34.35	686	1.53

Note: These are pipe flow rates at specified outlets, NOT channel flow rates. Catch basin flow rates are listed without a trash bucket—using a trash bucket reduces flow.

Underside

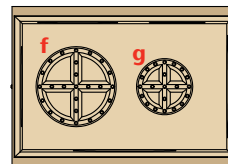

Catch Basin Outlet	Size (SCH 40)	Invert in	GPM	CFS
f	6"	35.90	734	1.69
g	4"	35.90	326	0.75

K3-904G/S In-Line Catch Basin

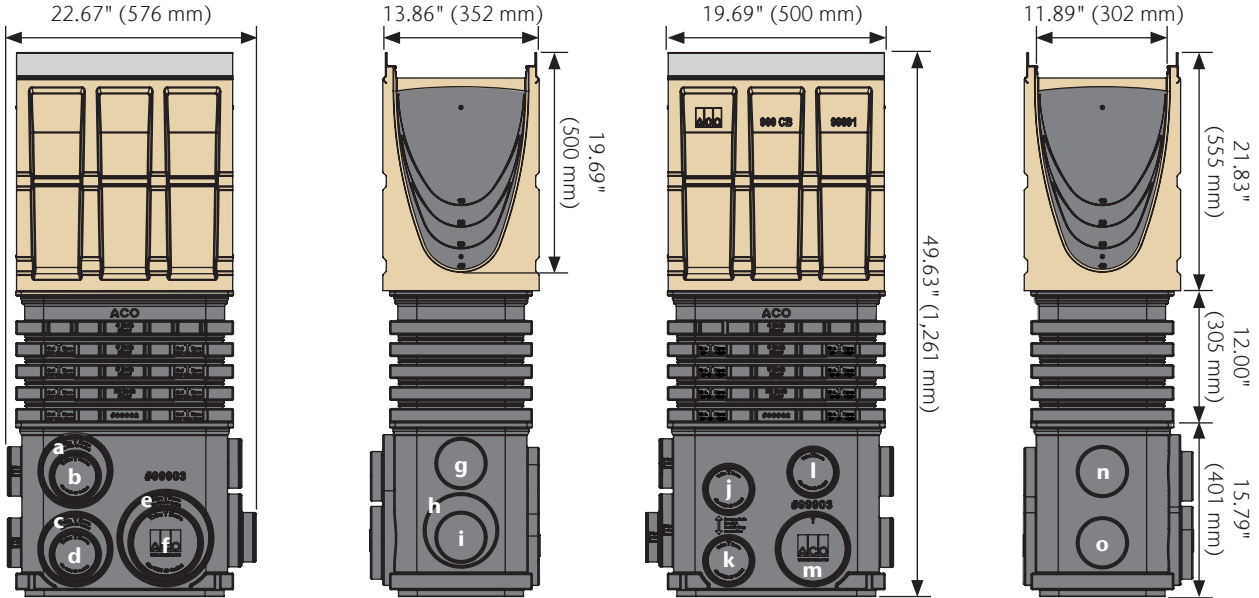

Catch Basin Outlet	Size (SCH 40)	Invert in	GPM	CFS
a	6"	41.15	757	1.69
b	4"	40.59	338	0.75
c	6"	48.28	824	1.84
d	4"	47.72	368	0.82
e	8"	48.28	1449	3.23
f	6"	47.72	819	1.83

Catch Basin Outlet	Size (SCH 40)	Invert in	GPM	CFS
g	4"	39.65	334	0.74
h	6"	46.78	810	1.81
i	4"	46.36	363	0.81

Catch Basin Outlet	Size (SCH 40)	Invert in	GPM	CFS
j	4"	41.80	343	0.77
k	4"	48.29	370	0.83
l	4"	40.22	337	0.75
m	6"	48.29	824	1.84

Catch Basin Outlet	Size (SCH 40)	Invert in	GPM	CFS
n	4"	40.37	337	0.75
o	4"	46.87	365	0.81

Note: These are pipe flow rates at specified outlets, NOT channel flow rates. Catch basin flow rates are listed without a trash bucket—using a trash bucket reduces flow.

Catch Basin Dimensions & Outlet Flow Rates (cont.)

K3-908G/S In-Line Catch Basin

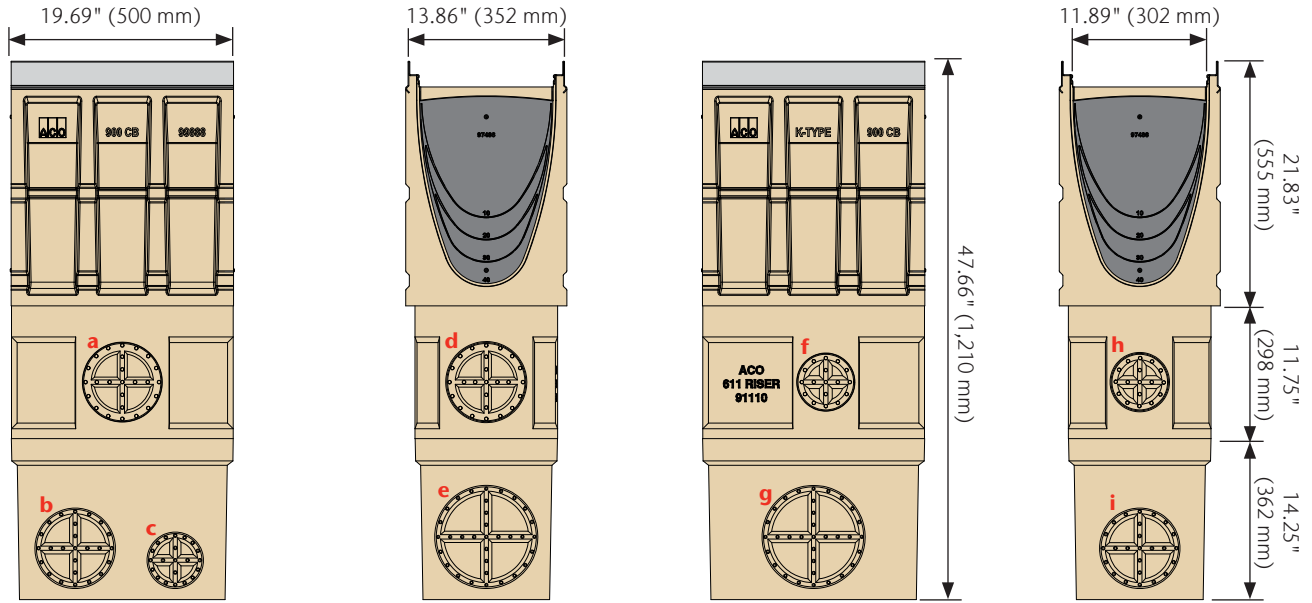

Catch Basin Outlet	Size (SCH 40)	Invert in	GPM	CFS
a	6"	31.65	655	1.51
b	6"	46.35	806	1.85
c	4"	46.42	363	0.83

Catch Basin Outlet	Size (SCH 40)	Invert in	GPM	CFS
d	6"	31.65	655	1.51
e	8"	46.35	1416	3.26

Catch Basin Outlet	Size (SCH 40)	Invert in	GPM	CFS
f	4"	30.65	291	0.67
g	8"	46.35	1416	3.26

Catch Basin Outlet	Size (SCH 40)	Invert in	GPM	CFS
h	4"	30.65	291	0.67
i	6"	46.35	806	1.85

Note: These are pipe flow rates at specified outlets, NOT channel flow rates. Catch basin flow rates are listed without a trash bucket—using a trash bucket reduces flow.

Underside

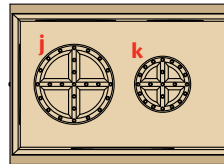

Catch Basin Outlet	Size (SCH 40)	Invert in	GPM	CFS
j	6"	47.66	845	1.94
k	4"	47.66	376	0.86

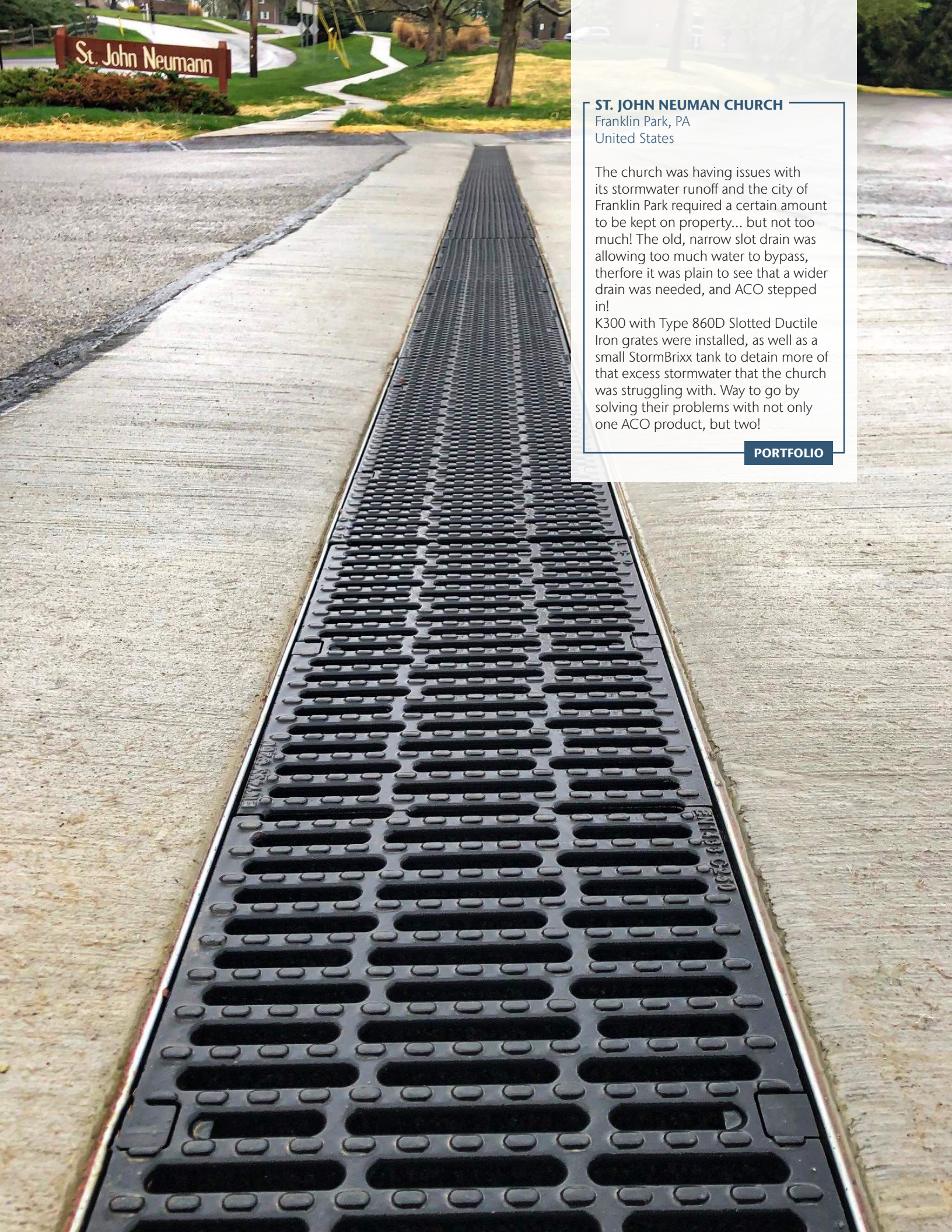

ST. JOHN NEUMAN CHURCH

Franklin Park, PA
United States

The church was having issues with its stormwater runoff and the city of Franklin Park required a certain amount to be kept on property... but not too much! The old, narrow slot drain was allowing too much water to bypass, therefore it was plain to see that a wider drain was needed, and ACO stepped in!

K300 with Type 860D Slotted Ductile Iron grates were installed, as well as a small StormBrixx tank to detain more of that excess stormwater that the church was struggling with. Way to go by solving their problems with not only one ACO product, but two!

PORTFOLIO

K300/KS300 Grates - DrainLok

KEY



ADA Compliant
Compliant with Americans with Disabilities Act of 2010, Section 302.3 (page 174)



Heel-Resistant
ASME A112.6.3 - 2001 Heel-resistant slot width less than 0.31" (8 mm) (page 174)



Heel-Safe
Heel-safe slot width equal or less than 0.25" (6.5 mm) (page 174)



Slip-Resistant Grates
BPN over 24 (page 174)



Bicycle-Safe
Compliant to Australian Standard AS 3996 - 2006 (page 174)



Non-Metallic
No metallic/magnetic parts included (page 170)

For details on how psi is determined, see pages 161-166.

	Part No.	Length in (m)	Slot Size in	Area in ²	Weight lbs	Slip-Resistant	ADA Compliant	Heel-Resistant	Heel-Safe	Bicycle-Safe
LOAD CLASS A (EN 1433 - 15 KN) - 3,372 LBS - 58 PSI (PEDESTRIAN TRAFFIC)										
LONGITUDINAL STEEL¹										
Type 847D - Stainless	142223	39.37 (1.0)	0.81 x 0.24	263.2	29.0	✓	✓	✓	✓	✓
Type 848D - Stainless	142224	19.69 (0.5)		131.6	14.0					
LOAD CLASS C (EN 1433 - 250 KN) - 56,202 LBS - 967 PSI (COMMERCIAL VEHICLE TRAFFIC)										
MESH STEEL										
Type 805D - Galvanized	133675	19.69 (0.5)	0.63 x 0.87	163.7	26.2	✓	✗	✗	✗	✓
Type 830D - Stainless ¹	133678	19.69 (0.5)		163.7	29.5					
SLOTTED IRON⁴										
Type 860D - Iron	13870	19.69 (0.5)	0.47 x 2.57 avg.	88.1	38.0	✓	✗	✗	✗	✓
LONGITUDINAL IRON⁴										
Type 876D - Iron	99588	19.69 (0.5)	1.97 x 0.24	64.3	35.0	✓	✓	✓	✓	✓
WAVE IRON⁴										
Type 880D - Iron	99581	19.69 (0.5)	0.27 x 0.9 avg.	88.5	37.0	✓	✓	✓	✗	✓

Notes

1. Grade 304 stainless steel 2. Polypropylene material 3. Ductile iron to ASTM A536 Grade 65-45-12 4. Ductile iron to ASTM A536 Grade 80-55-06

DRAINLOK - BOLTLESS & BARLESS LOCKING SYSTEM



Factory-fitted locking device removes need for bolts and bars and improves channel hydraulic capacity. The DrainLok mechanism clips into channel edge rail for rapid installation. DrainLok grates are fit with an anti-shunt mechanism that restricts unwanted grate movement when installed, improving durability and longevity of the system.



1
Position grate onto channel and align anti-shunt detail with recess in rail.



2
Push down or stand on grate until it clicks into position.



3
To remove first grate, insert grate removal tool into slots at end of grate, pull up sharply. Remaining grates can be removed by hand.

K300/KS300 Grates - QuickLok®

Part No.	Length in (m)	Slot Size in	Intake		
			Area in ²	Weight lbs	

LOAD CLASS C (EN 1433 - 250 KN) - 56,202 LBS - 967 PSI (COMMERCIAL VEHICLE TRAFFIC)

PERFORATED STEEL

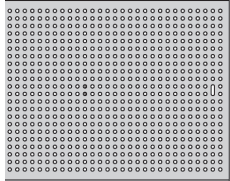

Type 811Q - Galvanized	98967	39.37 (1.0)		63.8	30.9	x				
Type 813Q - Galvanized	98966	19.69 (0.5)		31.9	15.0	x				
			Ø 0.25				✓	✓	✓	✓
Type 865Q - Stainless ¹	98968	39.37 (1.0)		63.8	30.9	✓				
Type 866Q - Stainless ¹	98969	19.69 (0.5)		31.9	15.0	✓				

LOAD CLASS E (EN 1433 - 600 KN) - 134,885 LBS - 2,321 PSI (INDUSTRIAL TRAFFIC)

LONGITUDINAL IRON⁴

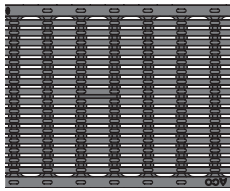

Type 878Q - Iron	138130	19.69 (0.5)	1.0 x 0.31	61.8	52.0	✓	✓	✓	✓	✓
------------------	---------------	-------------	------------	------	------	---	---	---	---	---

SLOTTED IRON⁴

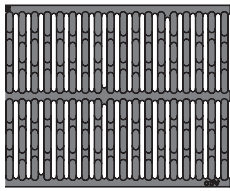

Type 861Q - Iron	10431	19.69 (0.5)	0.39 x 5.71	97.0	58.0	✓	x	x	x	✓
------------------	--------------	-------------	-------------	------	------	---	---	---	---	---



QUICKLOK® - BOLTLESS LOCKING SYSTEM

<p>1</p> <p>Fit locking bar</p> <p>Locate locking bar in channel wall recesses by rotating clockwise.</p>	<p>2</p> <p>Fit locking bar</p> <p>Use hammer to tap bar into place, so that serrated ends grip in recess.</p>	<p>3</p> <p>Fit grate</p> <p>To install grate, align QuickLok® stud directly over locking bar.</p>	<p>4</p> <p>Fit grate</p> <p>Push down or stand on grate until it clicks into position.</p>	<p>5</p> <p>Remove grate</p> <p>To remove first grate, insert grate removal tool into slots at end of grate, pull up sharply. Remaining grates can be removed by hand.</p>	<p>6</p> <p>Remove grate</p> <p>To remove bar, remove clips then insert screwdriver into hole at end of bar and lever back serrated end, rotate bar free.</p>
--	---	---	--	---	--





MiniKlassik K50/KS50

2" Internal Width General Purpose System

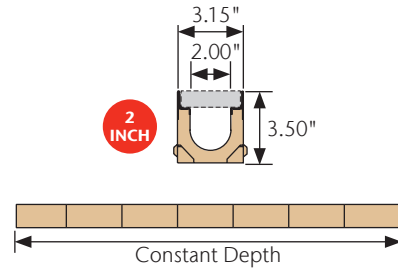

K50 is a 2" internal width system with galvanized steel edge rail for high profile, aesthetic applications where a barrier is required to separate wet and dry areas.













KS50 is the same system, but the edge rail is grade 304 stainless steel. KS50 should be used where increased aesthetics are required, or where increased corrosion resistance is required.

EN 1433 does not cover grates for 2" (50 mm) internal width trench drains, but grates have been load tested in accordance with EN 1433 guidelines. Grates feature patented DrainLok boltless locking systems. Loading is determined by grate up to Load Class C (25 ton).

Typical Applications:

- Pedestrian plazas
- Aesthetic areas
- Paved areas
- Sidewalks

MINIKLASSIK K50/KS50 SELECTION CRITERIA

		Light to medium duty loads	
		Product can be used towards LEED & EPA requirements	
		Resistant to many everyday chemicals	
			Multiple grate options to meet legal requirements
			Multiple grate options to meet design requirements
		Limited hydraulic capacity	
		Constant depth channels	



MiniKlassik Features

Wide Choice of Grates
 Various materials and styles (including ADA compliant) for applications from Load Class A to Load Class C.

DrainLok
 Patented, boltless locking system provides quick fitting and removal of grates. Helps reduce installation/maintenance time and cost.

Anti-Shunt Lugs
 Protrusions in grate fit into recesses on the edge rail to prevent longitudinal movement.

2" Internal Width Trench System
 Meter (39.37") channels with 'U' shaped bottom to improve flow hydraulics.

Integrally Cast-In Galvanized Steel Edge Rail
 Provides additional strength and protects the channel edge from damage. Stainless steel edge rail also available.

Interconnecting End Profiles
 Allow easy and effective joining of channels. Appropriate sealant can be used to create a sealed joint.

K50/KS50 Parts

	Part No.		Invert Depth	Overall Depth	Volume	Weight
	K50	K550	in (mm)	in (mm)	gal	lbs
Constant Depth Channel - 39.37" (1 m)	04071	06750	2.90 (74)	3.50 (89)	0.64	18.0
Steel Closing Cap	95395	95403	-	3.50 (89)	-	0.3

Notes

1. Preformed 1.5" dia. drill-out outlet on underside of channel provides a flow rate of 12.7 GPM - 0.03 CFS.
2. MiniKlassik does not fit with any ACO catch basin - discharge through vertical outlet only or contact ACO for additional advice.

Meter Channel

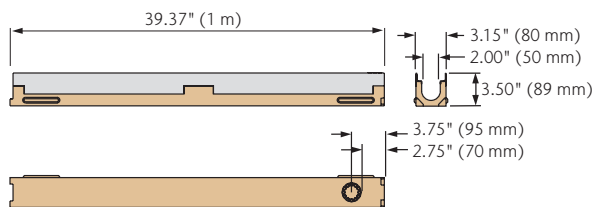

Closing Cap

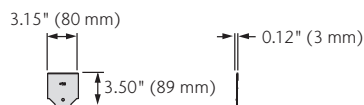

KEY



ADA Compliant
Compliant with Americans with Disabilities Act of 2010, Section 302.3 (page 174)



Heel-Resistant
ASME A112.6.3 - 2001 Heel-resistant slot width less than 0.31" (8 mm) (page 174)



Heel-Safe
Heel-safe slot width equal or less than 0.25" (6.5 mm) (page 174)



Slip-Resistant Grates
BPN over 24 (page 174)



Bicycle-Safe
Compliant to Australian Standard AS 3996 - 2006 (page 174)



Non-Metallic
No metallic/magnetic parts included (page 170)

For details on how psi is determined, see pages 161-166.

K50/KS50 Grates - Non-Locking

	Part No.	Length in (m)	Slot Size in	Intake Area in ²	Weight lbs					
LOAD CLASS A (EN 1433 - 15 KN) - 3,372 LBS - 70 PSI (PEDESTRIAN TRAFFIC)										
PERFORATED STEEL										
	Type 210D - Galvanized	94699	39.37 (1.0)	Ø 0.23	14.5	4.0	x	✓	✓	✓
	Type 251D - Stainless ¹	95165	39.37 (1.0)		14.5	4.0	x	✓	✓	✓
SLOTTED STEEL										
	Type 220D - Galvanized	95537	39.37 (1.0)	1.20 x 0.50	18.7	4.0	x	x	x	✓
	Type 250D - Stainless ¹	95545	39.37 (1.0)		18.7	4.0	x	x	x	✓

K50/KS50 Grates - DrainLok⁵

	Part No.	Length in (m)	Slot Size in	Intake Area in ²	Weight lbs					
LOAD CLASS A (EN 1433 - 15 KN) - 3,372 LBS - 70 PSI (PEDESTRIAN TRAFFIC)										
MOSAIC PLASTIC²										
	Type 200D - Black	138104	19.69 (0.5)		11.6	0.7				
	Type 201D - Gray	138105	19.69 (0.5)	0.3 x 1.2 avg.	11.6	0.7	x	✓	✓	x
	Type 202D - Tan	138106	19.69 (0.5)		11.6	0.7				
LOAD CLASS B (EN 1433 - 125 KN) - 28,101 LBS - 580 PSI (LIGHT DUTY TRAFFIC)										
LONGITUDINAL STEEL¹										
	Type 247D - Stainless	142436	39.37 (1.0)	1.46 x 0.24	14.9	5.9	✓	✓	✓	✓
LOAD CLASS C (EN 1433 - 250 KN) - 56,202 LBS - 1,160 PSI (COMMERCIAL VEHICLE TRAFFIC)										
LONGITUDINAL IRON⁴										
	Type 276D - Iron	138107	19.69 (0.5)	1.5 x 0.29	17.4	7.3	x	✓	✓	x

Notes

- Grade 304 stainless steel
- Polypropylene material
- Ductile iron to ASTM A536 Grade 65-45-12
- Ductile iron to ASTM A536 Grade 80-55-06
- DrainLok locking information can be found on page 36