

KlassikDrain - K200 Galvanized steel edge rail channel system

One meter channel

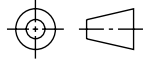

Inside view of channel - showing channel ID number and knockout if applicable (every 5th channel)



Half meter channel

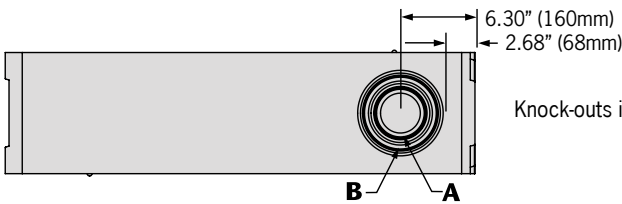
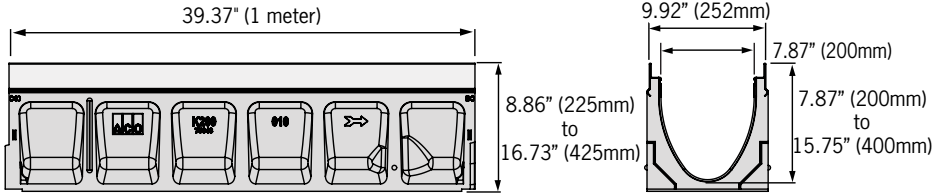
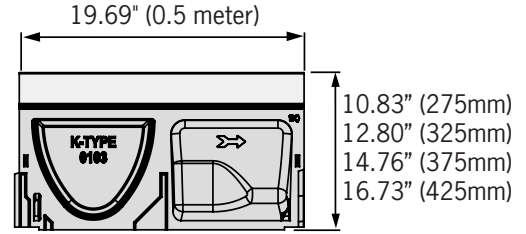

Knock-outs included on every 5th channel

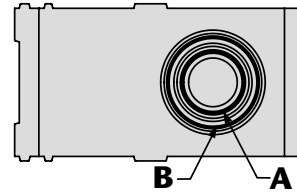

Type 902G In-line catch basin

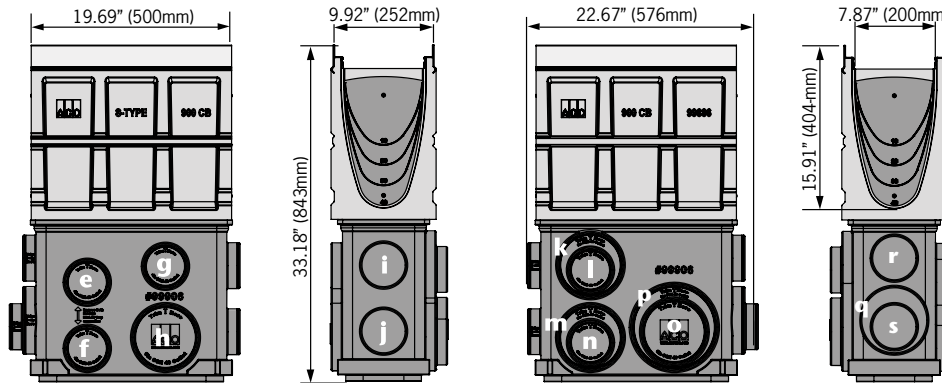

Total capacity = 19 gallons

Outlet flow rates

Outlet	Product	Outlet size (Sch. 40)	Invert Depth	GPM	CFS
A	Bottom outlet - K2-00	4" round	7.87"	153	0.34
A	Bottom outlet - K2-040	4" round	15.75"	216	0.48
B	Bottom outlet - K2-00	6" round	7.87"	344	0.77
B	Bottom outlet - K2-040	6" round	15.75"	486	1.08
C	End outlet - K2-00	4" round	7.87"	132	0.29
C	End outlet - K2-40	4" round	15.75"	202	0.45
D	End outlet - K2-10	6" round	9.84"	320	0.71
D	End outlet - K2-40	6" round	15.75"	437	0.97
E	Type K2-902G	4" round	25.33"	263	0.59
F	Type K2-902G	4" round	31.83"	297	0.66
G	Type K2-902G	4" round	23.76"	254	0.57
H	Type K2-902G	6" round	31.83"	658	1.47
I	Type K2-902G	4" round	23.91"	255	0.57
J	Type K2-902G	4" round	30.40"	290	0.65
K	Type K2-902G	6" round	24.68"	570	1.27
L	Type K2-902G	4" round	24.13"	256	0.57
M	Type K2-902G	6" round	31.82"	658	1.47
N	Type K2-902G	4" round	31.26"	294	0.66
O	Type K2-902G	6" round	31.26"	651	1.45
P	Type K2-902G	8" round	31.82"	1149	2.56
Q	Type K2-902G	6" round	30.32"	640	1.43
R	Type K2-902G	4" round	23.19"	251	0.56
S	Type K2-902G	4" round	29.90"	288	0.64

Note: These are the pipe flow rates at the specified outlet, NOT channel flow rates. *Catch basin flow rates are without trash bucket - using trash bucket reduces flow.

End Cap

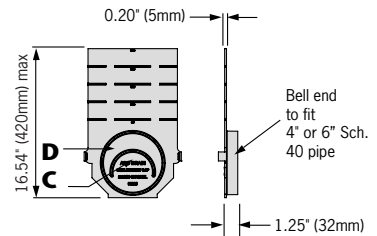

KlassikDrain - K200 Galvanized steel edge rail channel system



ACO Specification Information

Description	Part No.	Invert		Wgt Lbs.
		Inches ²	mm ²	
K2-00 Neutral channel - 39.37" (1m)[Ⓟ]	75041	7.87	200	83.6
K2-1 Sloped channel - 39.37" (1m)	75001	8.07	205	83.6
K2-2 Sloped channel - 39.37" (1m)	75002	8.27	210	84.7
K2-3 Sloped channel - 39.37" (1m)	75003	8.46	215	85.8
K2-4 Sloped channel - 39.37" (1m)	75004	8.66	220	86.9
K2-5 Sloped channel - 39.37" (1m) [Ⓟ]	75005	8.86	225	88.0
K2-6 Sloped channel - 39.37" (1m)	75006	9.06	230	89.1
K2-7 Sloped channel - 39.37" (1m)	75007	9.25	235	90.2
K2-8 Sloped channel - 39.37" (1m)	75008	9.45	240	91.3
K2-9 Sloped channel - 39.37" (1m)	75009	9.65	245	92.4
K2-10 Sloped channel - 39.37" (1m) [Ⓟ]	75010	9.84	250	93.5
K2-010 Neutral channel - 39.37" (1m)[Ⓟ]	75043	9.84	250	93.5
K2-0103 Neutral channel - 19.69" (0.5m)[Ⓟ]	75044	9.84	250	56.0
K2-11 Sloped channel - 39.37" (1m)	75011	10.04	255	94.6
K2-12 Sloped channel - 39.37" (1m)	75012	10.24	260	95.7
K2-13 Sloped channel - 39.37" (1m)	75013	10.43	265	96.8
K2-14 Sloped channel - 39.37" (1m)	75014	10.63	270	97.9
K2-15 Sloped channel - 39.37" (1m) [Ⓟ]	75015	10.83	275	99.0
K2-16 Sloped channel - 39.37" (1m)	75016	11.02	280	100.1
K2-17 Sloped channel - 39.37" (1m)	75017	11.22	285	101.2
K2-18 Sloped channel - 39.37" (1m)	75018	11.41	290	102.3
K2-19 Sloped channel - 39.37" (1m)	75019	11.61	295	103.4
K2-20 Sloped channel - 39.37" (1m) [Ⓟ]	75020	11.81	300	104.5
K2-020 Neutral channel - 39.37" (1m)[Ⓟ]	75045	11.81	300	104.5
K2-0203 Neutral channel - 19.69" (0.5m)[Ⓟ]	75046	11.81	300	64.0
K2-21 Sloped channel - 39.37" (1m)	75021	12.01	305	105.6
K2-22 Sloped channel - 39.37" (1m)	75022	12.20	310	106.7
K2-23 Sloped channel - 39.37" (1m)	75023	12.40	315	107.8
K2-24 Sloped channel - 39.37" (1m)	75024	12.60	320	108.9
K2-25 Sloped channel - 39.37" (1m) [Ⓟ]	75025	12.80	325	110.0
K2-26 Sloped channel - 39.37" (1m)	75026	12.99	330	111.1
K2-27 Sloped channel - 39.37" (1m)	75027	13.19	335	112.2

Description	Part No.	Invert		Wgt Lbs.
		Inches ²	mm ²	
K2-28 Sloped channel - 39.37" (1m)	75028	13.39	340	113.3
K2-29 Sloped channel - 39.37" (1m)	75029	13.58	345	114.4
K2-30 Sloped channel - 39.37" (1m) [Ⓟ]	75030	13.78	350	115.5
K2-030 Neutral channel - 39.37" (1m)[Ⓟ]	75047	13.78	350	115.5
K2-0303 Neutral channel - 19.69" (0.5m)[Ⓟ]	75048	13.78	350	68.0
K2-31 Sloped channel - 39.37" (1m)	75031	13.98	355	116.6
K2-32 Sloped channel - 39.37" (1m)	75032	14.17	360	117.7
K2-33 Sloped channel - 39.37" (1m)	75033	14.37	365	118.8
K2-34 Sloped channel - 39.37" (1m)	75034	14.57	370	119.9
K2-35 Sloped channel - 39.37" (1m) [Ⓟ]	75035	14.76	375	121.0
K2-36 Sloped channel - 39.37" (1m)	75036	14.96	380	122.1
K2-37 Sloped channel - 39.37" (1m)	75037	15.16	385	123.2
K2-38 Sloped channel - 39.37" (1m)	75038	15.35	390	124.3
K2-39 Sloped channel - 39.37" (1m)	75039	15.55	395	125.4
K2-40 Sloped channel - 39.37" (1m) [Ⓟ]	75040	15.75	400	126.5
K2-040 Neutral channel - 39.37" (1m)[Ⓟ]	75049	15.75	400	126.5
K2-0403 Neutral channel - 19.69" (0.5m)[Ⓟ]	75050	15.75	400	77.0
K2-901G In-line catch basin - 19.69" (0.5m) [Ⓟ]	94611	32.81	833.3	68.0
K2-621G catch basin - 19.69" (0.5m) [Ⓟ]	94620	37.33	948.1	91.0
K2-631G catch basin - 19.69" (0.5m) [Ⓟ]	94633	49.33	1252.9	101.0
K2-Series 600 Optional plastic riser	99902	-	-	10.0
Foul air trap - fits both 900 & 600 series basins	90854	-	-	1.2
Universal end cap	96821	15.71	399	1.4
Debris strainer for 8" bottom knockout	93488	-	-	0.2
K2-Installation device	97478	-	-	2.8
Grate removal tool	01318	-	-	0.3
K2-QuickLok locking bar	10457	-	-	0.5

Notes:

- This channel offers a bottom knockout feature; 4" & 6" round
- Inverts shown are for the male end; for female invert depth subtract 5mm (=0.2") from the male invert (except for neutral channels, where it will be same as male invert). To calculate the overall channel depth add 25mm (=1.0") to invert depth.
- This catch basin kit includes a polymer concrete top, removable Quicklok locking bar, trash bucket and plastic base. Select an appropriate grate.
- This catch basin kit includes a polymer concrete top, removable Quicklok locking bar, deep trash bucket, plastic riser and plastic base. Select an appropriate grate.

Specifications		Water absorption	0.07%	cast in by the manufacturer to ensure maximum homogeneity between polymer concrete body and edge rail. Each edge rail shall be at least 3/32" (2.5mm) thick.
General The surface drainage system shall be ACO Drain K200 complete with gratings secured with 'QuickLok' locking as manufactured by ACO, Inc. or approved equal.		Frost proof	YES	
		Salt proof	YES	
		Dilute acid and alkali resistant	YES	
Materials The trench system bodies shall be manufactured from polyester polymer concrete with the minimum properties as follows: Compressive strength: 14,000 psi Flexural strength: 4,000 psi		The nominal clear opening shall be 8" (200mm) with overall width of 10.24" (260mm). Pre-cast units shall be manufactured with either an invert slope of 0.5% or with neutral invert and have a wall thickness of at least 0.50" (13mm). Each unit will feature a partial radius in the trench bottom and a male to female interconnecting end profile. Units shall have horizontal cast in anchoring keys on the outside wall to ensure maximum mechanical bond to the surrounding bedding material and pavement surface. The galvanized steel edge rail will be integrally		Grates Grates shall be specified. See separate ACO Spec Info grate sheets for details. After removal of gratings and 'QuickLok' bar there shall be uninterrupted access to the trench to aid maintenance.
		Installation The trench drain system shall be installed in accordance with the manufacturer's installation instructions and recommendations.		

ACO, Inc.
Northeast Sales Office
 9470 Pinecone Drive
 Mentor, OH 44060
 Tel: (440) 639-7230
 Toll free: (800) 543-4764
 Fax: (440) 639-7235

West Sales Office
 825 W. Beechcraft St.
 Casa Grande, AZ 85122
 Tel: (520) 421-9988
 Toll Free: (888) 490-9552
 Fax: (520) 421-9899

Southeast Sales Office
 4211 Pleasant Road
 Fort Mill, SC 29708
 Toll free: (800) 543-4764
 Fax: (803) 802-1063

Electronic Contact:
 info@ACODrain.us
 www.ACODrain.us



© April 2018 ACO, Inc. This information is believed to be accurate but it is not guaranteed to be so. We cannot assume liability for results that buyer obtains with our product since conditions of use are beyond the control of the company. It is the customer's responsibility to evaluate suitability and safety of product for his own use. ACO, Inc. reserves the right to change the product and specifications without notice.