



Slab Solutions

Trench Drains for Concrete Slabs

SlabDrains are problem-solving trench drains. Due to the nature of their use, they are usually installed in concrete slabs, but not always.

The most common use of SlabDrain is in shallow depth installations. Whether due to elevated slabs or depth restrictions, SlabDrains allow a practical trench drain solution. In addition to shallow channels, FlowDrain gives a unique trench drain ideal for draining large concrete slabs.



Features & Benefits



FG200 Bolted Grates

FG200 grates are lockable with two ½" - 13 x 1½" bolts fixing directly into steel frame at 18" (457 mm) intervals.



Ductile Iron Grates

Heavy duty ductile iron grates in choice of Load Class F slotted or longitudinal ADA compliant (H200SK & H300SK ADA grates are rated to Load Class E). A 4-Bolt slotted grate is also available.

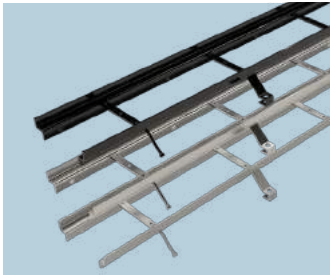

Choice of Steel Frame

Provides grate support and protects channel edge from damage. Available in black coated, galvanized and stainless steel.



FG200 Fiberglass

A lightweight material that is made from polyester resin binder reinforced by glass matting and fibers. Available in 9' and 3' lengths.



Anti-Shunt Lugs

Recesses in grate fit around lugs on the edge rail to prevent longitudinal movement.

H100SK/H200SK/H300SK Integrally Cast-In Ductile Iron Edge Rail

Provides maximum strength and protection for channel body.

H100K/H200K/H300K Integrally Cast-In Galvanized Steel Edge Rail

Provides maximum strength and protection for channel body.

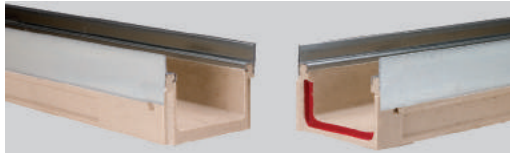

Interconnecting End Profiles

Allow easy and effective joining of channels.

SF Sealant Groove - A groove is cast into the ends of every channel. The combined groove this creates allows for a positive bead of appropriate flexible sealant to be inserted at joints.

H100 Polymer Concrete Edge

Ideal for situations where metals cannot be used.



Wide Choice of Grates

In various materials, styles and slot configurations (including ADA compliant).
H100 - From Load Class A to Load Class C (25 tons).
H100K/H200K/H300K - From Load Class A to Load Class E (60 tons).

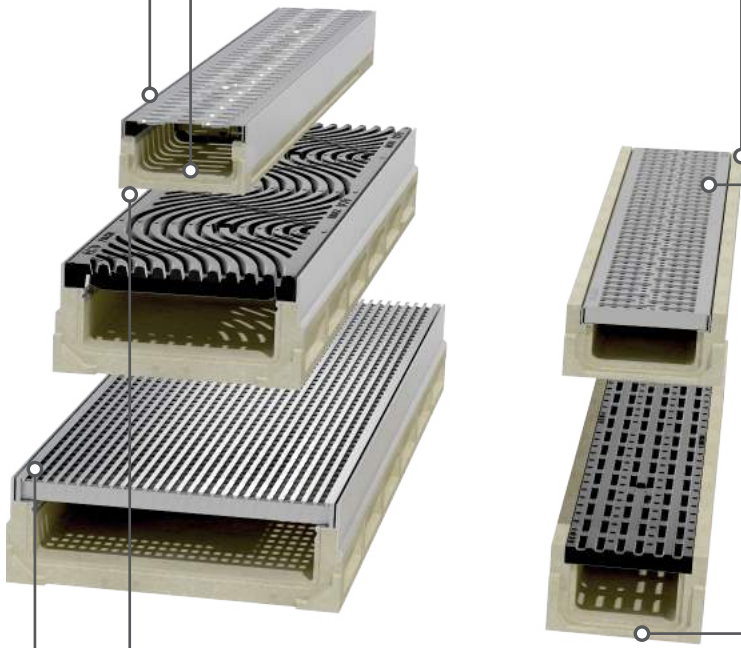

Bottom Drill-Outs

Included on all channels to allow vertical evacuation of the system at any point in the run.

Drill-outs sized for:

4" pipes - H100/H100K/H100SK

4" & 6" pipes - H200K/H200SK

6" & 8" pipes - H300K/H300SK



Cross Sidewalk Drain

Allows water from a down spout to drain safely, through the SlabDrain, across the sidewalk to the curb.



QuickLok® & DrainLok on H100K/H200K/H300K

Patented, boltless locking systems provide quick fitting and removal of grates. Helps reduce installation/maintenance time and cost. H100 will accept QuickLok® grates only.



SlabDrain

Shallow Invert Trench Drain

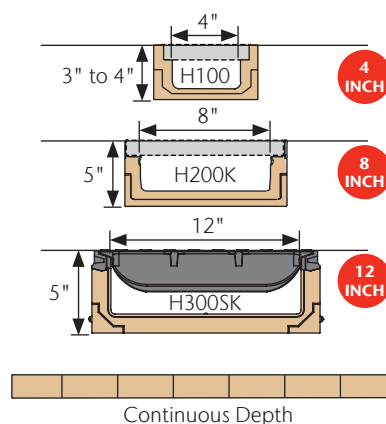

On occasion, installation constraints are of greater concern than hydraulics. The most common constraint is lack of depth. To offer solutions where shallow trench drains are required, SlabDrain is available in 3 edge versions and 3 widths - all constant depth.

Loading varies for each system, depending upon edge rail and grate, up to heavy duty Class F (90 tons) EN 1433. All grates are secured to the channel body by either QuickLok® or PowerLok.

Typical Applications:

- Restricted depth applications
- Threshold applications
- Elevated slabs
- Parking decks
- Retro-fit

SLABDRAIN SELECTION CRITERIA

	<p>Light to heavy industrial duty loads - dependent on type</p>
	<p>Product can be used towards LEED & EPA requirements</p>
	<p>Resistant to many everyday chemicals</p>
	<p>Polymer concrete edge rail on H100-8/H100-10 can be used to provide a non-metallic drainage option</p> <p>Multiple grate options to meet legal requirements</p>
	<p>Multiple grate options to meet design requirements</p>
	<p>Limited hydraulic capacity</p>
	<p>Constant depth channels</p>



SlabDrain - H100K/H200K/H300K & H100KS/H200KS/H300KS System Layouts

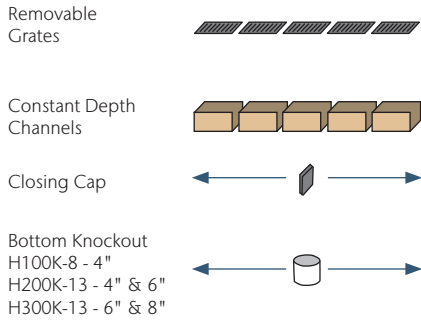

OUTLET FLOW RATES

Channel Outlet	Channel	Size (SCH 40)	Invert in	GPM	CFS
A	Bottom Outlet - H100K-6/H100SK-6	4" round	1.78	72	0.16
	Bottom Outlet - H100K-8/H100SK-8	4" round	2.56	87	0.20
	Bottom Outlet - H200K-13/H200SK-13	4" round	4.00	108	0.24
	Bottom Outlet - H300K-13/H300SK-13	6" round	4.00	243	0.54
B	Bottom Outlet - H200K-13/H200SK-13	6" round	4.00	243	0.54
	Bottom Outlet - H300K-13/H300SK-13	8" round	4.00	432	0.96

Note: These are pipe flow rates at specified outlet, NOT channel flow rates.

H100K-6/H100KS-6 Channel

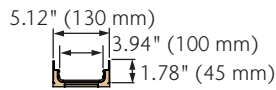
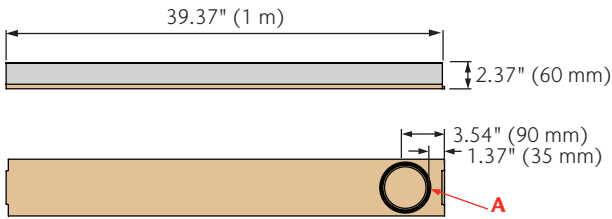

Closing Cap

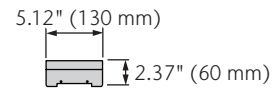

H100K-8/H100KS-8 Channel

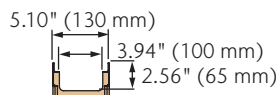
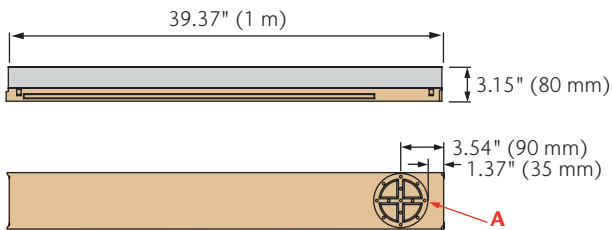

Closing Cap

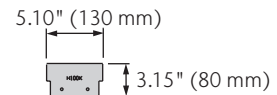

H200K-13/H200KS-13 Channel

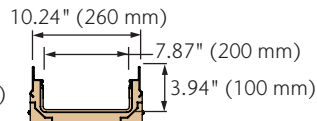
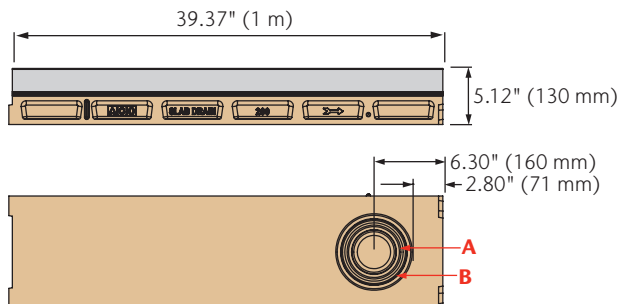

Closing Cap

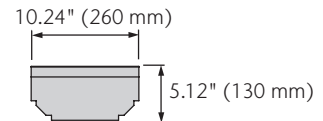

H300K-13/H300KS-13 Channel

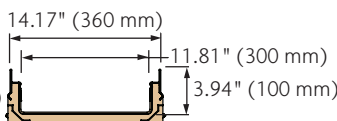
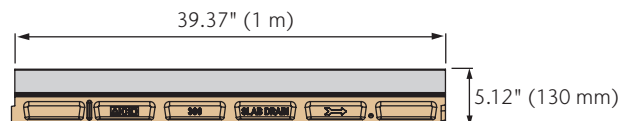

Closing Cap

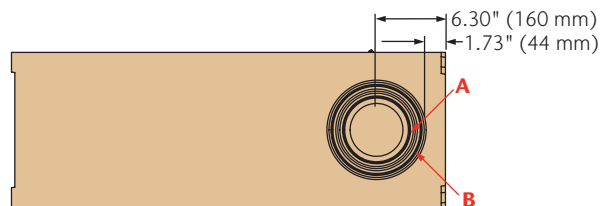
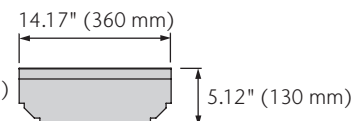

SlabDrain Parts



	Part No.		Invert Depth		Overall Depth		Volume gal	Weight lbs
	K	KS	in	mm	in	mm		
H100K-6/H100KS-6								
Constant Depth Channel - 39.37" (1 m)	141803	141804	1.78	45	2.37	60	1.2	7.6
Steel Closing Cap	141805	296097	-	-	2.37	60	-	1.0
Debris Strainer for 4" Bottom Knockout		93488	-	-	-	-	-	0.1
Grate Removal Tool		01318	-	-	-	-	-	0.1

Notes:

- H100KS-6 has Grade 304 stainless steel rails and Closing Cap.
- See pages 35-38 for details on grates; for optimum channel flow, use DrainLok grates.

H100K-8/H100KS-8

Constant Depth Channel - 39.37" (1 m)	95365	95373	2.56	65	3.15	80	1.2	16.0
Steel Closing Cap	98462	98471	-	-	3.15	80	-	1.0
Debris Strainer for 4" Bottom Knockout		93488	-	-	-	-	-	0.2
QuickLok® Locking Bar for 4" Systems		02899	-	-	-	-	-	0.1
Grate Removal Tool		01318	-	-	-	-	-	0.3

Notes:

- H100KS-8 has Grade 304 stainless steel rails and Closing Cap.
- See pages 35-38 for details on grates; for optimum channel flow, use DrainLok grates.
- For Debris Strainer details, see page 138.

H200K-13/H200KS-13

Constant Depth Channel - 39.37" (1 m)	93454	93455	4.00	100	2.37	60	1.2	57.4
Steel Closing Cap	93458	93459	-	-	6.89	175	-	1.0
Debris Strainer for 4" Bottom Knockout		93488	-	-	-	-	-	0.2
QuickLok® Locking Bar for 8" Systems		10457	-	-	-	-	-	0.5
Grate Removal Tool		01318	-	-	-	-	-	0.3

Notes:

- H200KS-13 has Grade 304 stainless steel rails and Closing Cap.
- See pages 55-56 for details on grates; for optimum channel flow, use DrainLok grates.
- For Debris Strainer details, see page 138.

H300K-13/H300KS-13

Constant Depth Channel - 39.37" (1 m)	93464	93465	4.00	100	2.37	60	1.2	71.6
Steel Closing Cap	93468	93469	-	-	7.48	190	-	1.4
QuickLok® Locking Bar for 12" Systems		10458	-	-	-	-	-	0.7
Grate Removal Tool		01318	-	-	-	-	-	0.3

Notes:

- H300KS-13 has Grade 304 stainless steel rails and Closing Cap.
- See pages 77-78 for details on grates; for optimum channel flow, use DrainLok grates.

SlabDrain - H100SK/H200SK/H300SK System Layouts

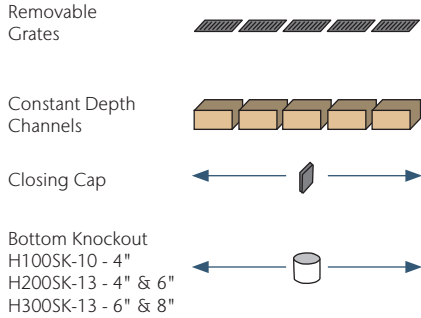

OUTLET FLOW RATES

Channel Outlet	Channel	Size (SCH 40)	Invert in	GPM	CFS
A	Bottom Outlet - H100SK-10	4" round	2.56	87	0.20
	Bottom Outlet - H200SK-13		4.00	108	0.24
	Bottom Outlet - H300SK-13		4.00	243	0.54
B	Bottom Outlet - H200SK-13	6" oval	4.00	243	0.54
	Bottom Outlet - H300SK-13		4.00	432	0.96

Note: These are pipe flow rates at specified outlet, NOT channel flow rates.

H100SK-10 Channel

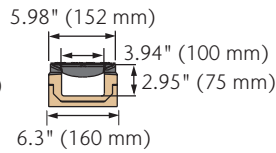
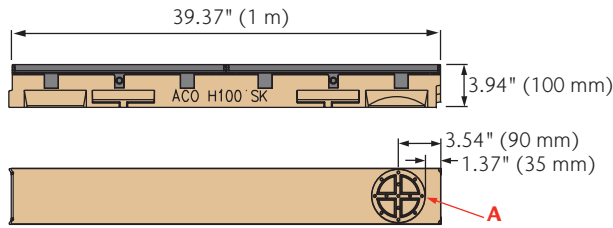

Closing Cap

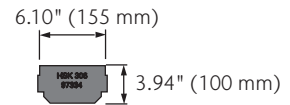

H200SK-13 Channel

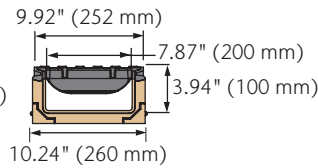
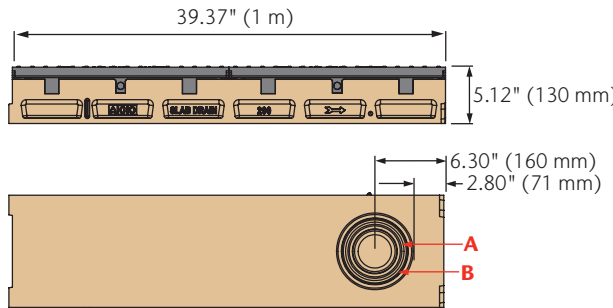

Closing Cap

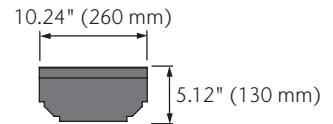

H300SK-13 Channel

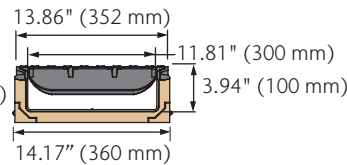
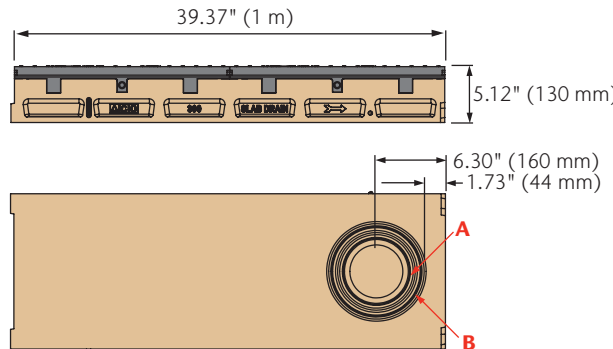

Closing Cap

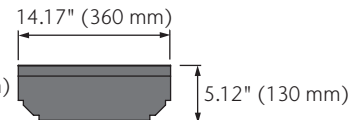

SlabDrain Parts



	Part No.	Invert Depth		Overall Depth		Volume gal	Weight lbs
		in	mm	in	mm		
H100SK-10							
Constant Depth Channel (no Grate) - 39.37" (1 m)	93412	2.83	72	3.15	80	1.2	43.5
Load Class F Longitudinal Grate - 19.69" (0.5 m) PowerLok	96096	-	-	-	-	-	13.6
Load Class F Slotted Grate - 19.69" (0.5 m) PowerLok	96082	-	-	-	-	-	12.3
Load Class F 4-Bolt Grate - 19.69" (0.5 m)	99590	-	-	-	-	-	10.8
Replacement Bolt	95526	-	-	-	-	-	0.1
Tamper-Resistant Bolt for 4-Bolt Grate	138127	-	-	-	-	-	0.1
PowerLok Safety Clip	10443	-	-	-	-	-	0.1
Steel Closing Cap	93410	-	-	3.15	80	-	1.0
Debris Strainer for 4" Bottom Knockout	93488	-	-	-	-	-	0.2
Grate Removal Tool	01318	-	-	-	-	-	0.3

Notes:

1. See pages 99–100 for details on Grates.
2. Debris Strainer details for 4" dia. outlet below.

H200SK-13

Constant Depth Channel (no Grate) - 39.37" (1 m)	63456	3.94	100	5.12	130	3.7	66.4
Load Class E Longitudinal Grate - 19.69" (0.5 m) PowerLok	72263	-	-	-	-	-	26.4
Load Class F Slotted Grate - 19.69" (0.5 m) PowerLok	02449	-	-	-	-	-	30.8
Load Class F 4-Bolt Grate - 19.69" (0.5 m)	99591	-	-	-	-	-	26.4
Replacement Bolt	95526	-	-	-	-	-	0.1
Tamper-Resistant Bolt for 4-Bolt Grate	138127	-	-	-	-	-	0.1
PowerLok Safety Clip	10443	-	-	-	-	-	0.1
Steel Closing Cap	93460	-	-	5.12	130	-	1.0
Debris Strainer for 4" Bottom Knockout	93488	-	-	-	-	-	0.2
Grate Removal Tool	01318	-	-	-	-	-	0.3

Notes:

1. See pages 113–114 for details on Grates.
2. Debris Strainer details for 4" dia. outlet below.

H300SK-13

Constant Depth Channel (no Grate) - 39.37" (1 m)	63466	3.94	100	5.12	130	5.5	82.2
Load Class E Longitudinal Grate - 19.69" (0.5 m) PowerLok	96833	-	-	-	-	-	64.0
Load Class F Slotted Grate - 19.69" (0.5 m) PowerLok	02445	-	-	-	-	-	50.0
Load Class F 4-Bolt Grate - 19.69" (0.5 m)	99592	-	-	-	-	-	50.2
Replacement Bolt	95526	-	-	-	-	-	0.1
Tamper-Resistant Bolt for 4-Bolt Grate	138127	-	-	-	-	-	0.1
PowerLok Safety Clip	10443	-	-	-	-	-	0.1
Steel Closing Cap	93470	-	-	5.12	130	-	1.4
Grate Removal Tool	01318	-	-	-	-	-	0.3

Notes:

1. See pages 127–128 for details on Grates.

Debris Strainer

Plastic strainer used to catch leaves and other items fallen in channel. Can be used with any ACO Drain® channel with 4" vertical outlet.

Cannot be used with H100K-6 (height restriction).



Part no. 93488

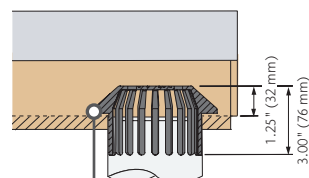

Lip sits on invert of channel

SlabDrain - H100 System Layout

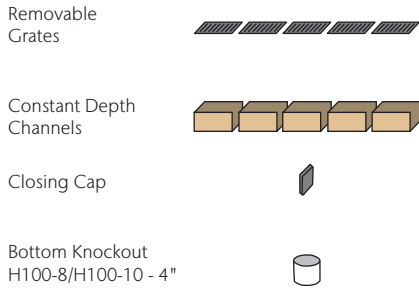

OUTLET FLOW RATES

Channel Outlet	Channel	Size (SCH 40)	Invert in	GPM	CFS
A	Bottom Outlet - H100-8	4" round	2.56	87	0.20
	Bottom Outlet - H100-10		3.35	99	0.23

Note: These are pipe flow rates at specified outlet, NOT channel flow rates.

H100-8/10 Channel

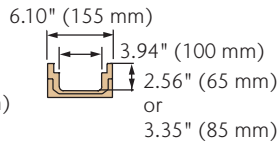
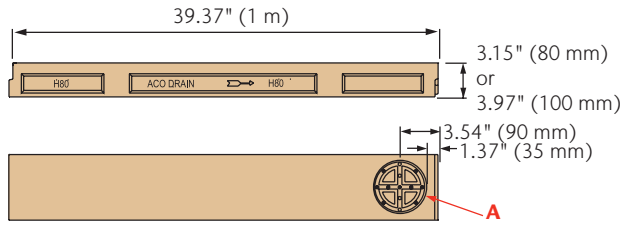

Closing Cap

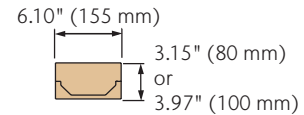

SlabDrain Parts



Part No.	Invert Depth		Overall Depth		Volume gal	Weight lbs
	in	mm	in	mm		
H100-8/H100-10						
H100-8 Constant Depth Channel - 39.37" (1 m)	2.56	65	3.15	80	1.16	20.0
H100-10 Constant Depth Channel - 39.37" (1 m)	3.35	85	3.95	100	1.70	25.0
H100-8 Polymer Concrete Closing Cap	-	-	3.15	80	-	1.0
H100-10 Polymer Concrete Closing Cap	-	-	3.95	100	-	1.0
Debris Strainer for 4" Bottom Knockout	-	-	-	-	-	0.2
Grate Removal Tool	-	-	-	-	-	0.3
QuickLok® Locking Bar for 4" System	-	-	-	-	-	0.1

Notes:

- See page 37 for details on suitable QuickLok® grates, max. load Class C (56,202 lbs - 1,934 psi).
- Debris strainer details for 4" dia. outlet on page 138.
- Use with Black Plastic Longitudinal grate (part no. 97393) or Gray Plastic Longitudinal grate (part no. 97385) for non-metallic, non-locking option (see ACO Sport® System 4000 Brochure - SP202).





VETERANS MEMORIAL BRIDGE

Cleveland, OH
United States

Veterans Memorial Bridge was originally The Detroit Superior Bridge established in 1917. The bridge was renamed Veterans Memorial Bridge on Veterans Day, 1989.

When refurbishing the 3,112' structure, a trench drain was needed to run the length of the bridge to remove rainfall. With the road and sidewalk at the same level, a single run of trench drain located away from vehicle traffic could not drain both areas. Due to depth restrictions, a shallow system was needed and SlabDrain H100 with Type 494 ADA plastic grates was selected.

PORTFOLIO

Cross Sidewalk Drain (CSD) System Layout

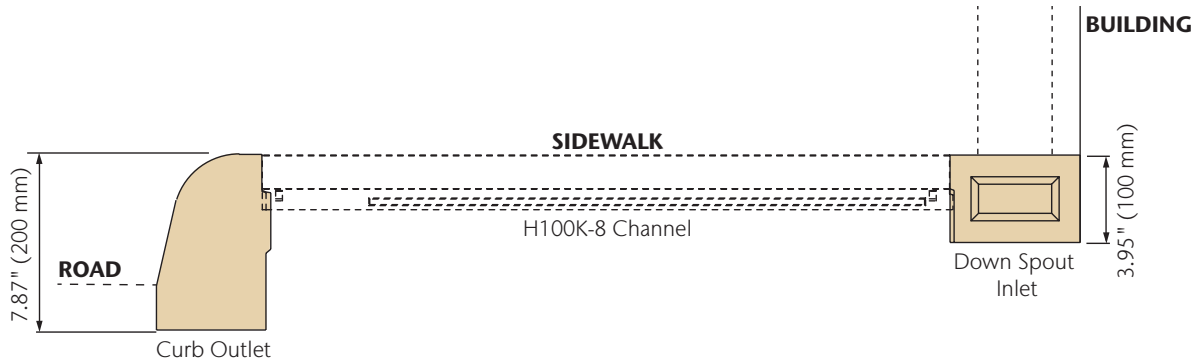

CSD is a cross-sidewalk drainage system which has a polymer concrete curb unit, that is cast into the curb line, to allow water from the H100K-8 or H100KS-8 SlabDrain to discharge into the road. A down spout inlet, also manufactured from polymer concrete, allows rainwater down spouts to drain into the channel.



CSD Parts

	Part No.	Invert Depth		Overall Depth		Weight lbs
		in	mm	in	mm	
Curb Outlet - Type 6 Profile	96924	3.50	90	7.87	200	12.7
Down Spout Inlet	96932	3.20	82	3.95	100	6.0

Notes:

1. For use with H100K-8 or H100KS-8 channels only - see page 136 for details.

Membrane No-Hub Drain

	Part No.	Outlet Size	GPM	CFS	Weight lbs
		in (mm)			
Membrane No-Hub Drain - Stainless Steel	01043	4.33 (110)	79.25	0.18	8.9

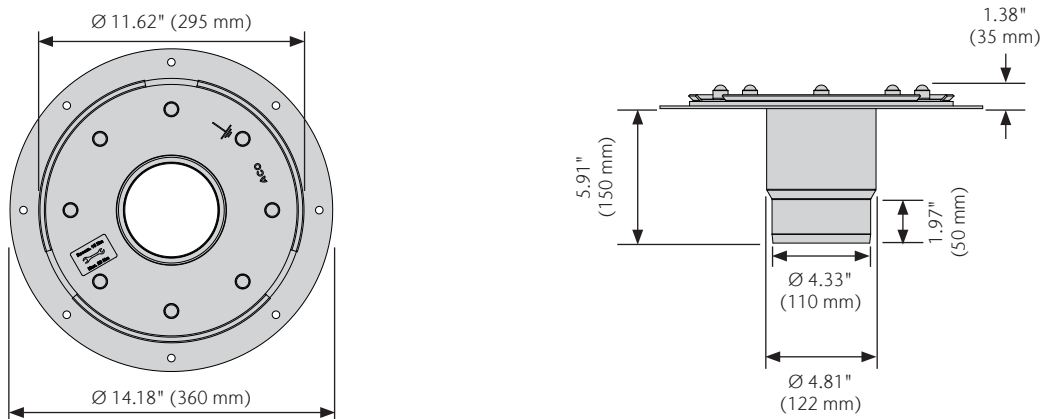



ONE WELLS FARGO CENTER

Charlotte, NC
United States

Formerly known as One Wachovia Center, this skyscraper is located in the heart of downtown Charlotte and is the headquarters for Wells Fargo's east coast division.

During renovations a drain system was requested that could remove rainwater from the pedestrian area and fit into an existing shallow recess. ACO's H100KS SlabDrain with stainless steel grates and shallow invert fit easily into the existing elevated slab.

The trench drain with stainless steel edge railing and ADA stainless steel grates provided superior aesthetics and added to the overall look of the plaza while removing excess stormwater.

PORTFOLIO



FlowDrain FG200

8" Internal Width Fiberglass System

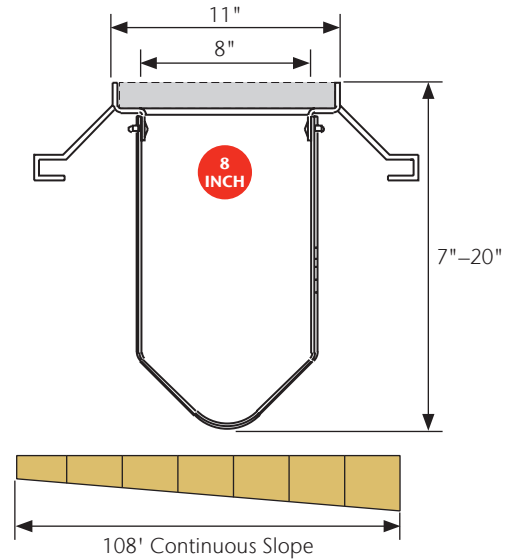

FG200 is an 8" wide fiberglass system with choice of steel slotted Class C (25 ton) or ductile iron Class E (60 ton) grates. Grates are bolted into the steel frame with 2 bolts per 18" section.

Typical Applications:

- Parking lots & garages
- Internal applications
- Commercial areas
- Industrial areas
- Gas stations
- Airports

FLOWDRAIN SELECTION CRITERIA

		Light to heavy industrial duty loads	
		Product can be used towards LEED & EPA requirements	
		Resistant to many everyday chemicals	
			Multiple grate options to meet legal requirements
			Multiple grate options to meet design requirements
			Increased hydraulic capacity
			Constant depth and/or sloped depth channels



Features & Benefits



Choice of Grates

In various materials and styles (including ADA compliant) for applications up to Load Class E.



Bolted Grates

FG200 grates are lockable with two 1/2" - 13 x 1 1/2" bolts fixing directly into steel frame at 18" (457 mm) intervals.

K200 8" INTERNAL WIDTH

Bracing Blocks

Supplied to brace deeper channels during concrete pour, details on how to position are shown on a sticker on each channel.

Interconnecting end profiles

Allow easy and effective joining of channels. Sealant can be used to create sealed joints.

Nelson Studs

Attached to frame, act as concrete anchors to secure channels into concrete surround.

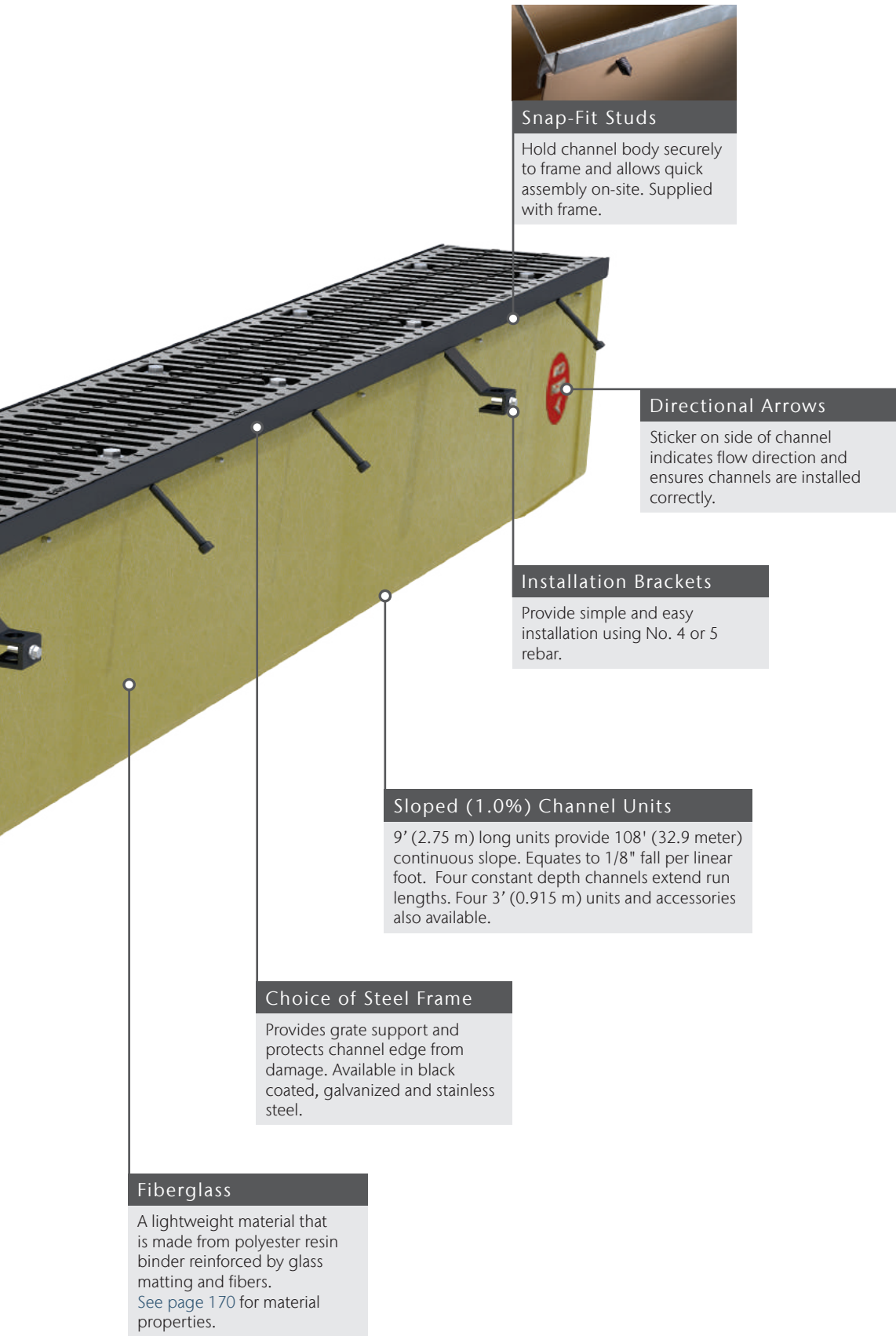

Snap-Fit Studs

Hold channel body securely to frame and allows quick assembly on-site. Supplied with frame.

Directional Arrows

Sticker on side of channel indicates flow direction and ensures channels are installed correctly.

Installation Brackets

Provide simple and easy installation using No. 4 or 5 rebar.

Sloped (1.0%) Channel Units

9' (2.75 m) long units provide 108' (32.9 meter) continuous slope. Equates to 1/8" fall per linear foot. Four constant depth channels extend run lengths. Four 3' (0.915 m) units and accessories also available.

Choice of Steel Frame

Provides grate support and protects channel edge from damage. Available in black coated, galvanized and stainless steel.

Fiberglass

A lightweight material that is made from polyester resin binder reinforced by glass matting and fibers. See page 170 for material properties.

FG200 System Layout

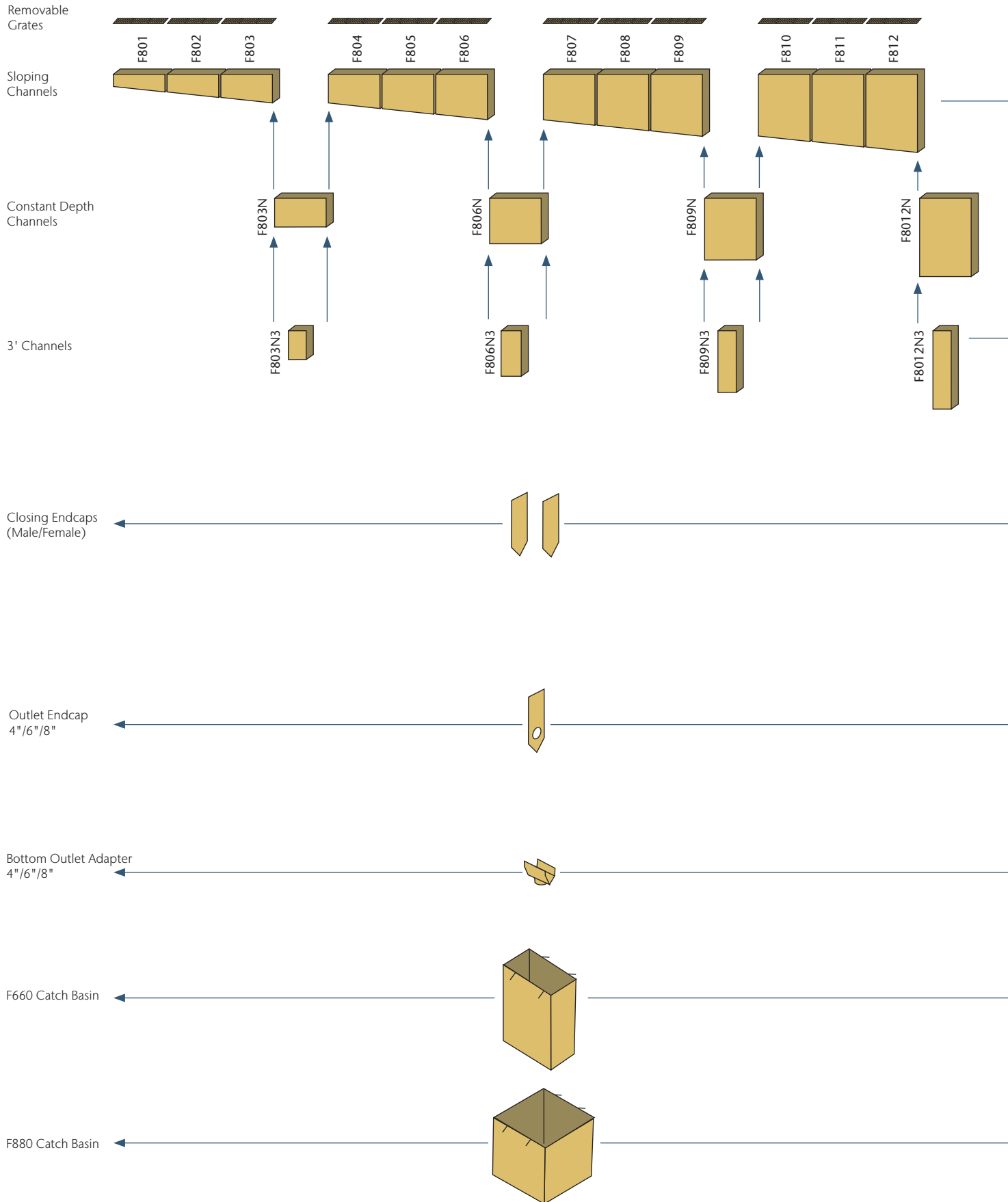



9' Channels

1.0% sloped channels in 9' lengths and 12 depths which connect to create 108' (32.9 m) continuously sloping trench run. Constant depth channels are available in 4 depths and can be used to create non-sloped runs or inserted in sloped runs to increase length. Choice of 9' black coated, stainless or galvanized steel frame connects to channel body using simple snap-fit studs.



3' Channels

Constant depth channels in 4 depths to supplement the 9' channels for easier layouts. Choice of 3' black coated, stainless or galvanized steel frame connects to channel body using simple snap-fit studs.



Male Closing Cap

Fits outside deep/male end of all channels. Manufactured from plastic with choice of black coated, stainless or galvanized steel end rail. Guides aid cutting to correct height. Seal using appropriate flexible sealant.

Female Closing Cap

Fits inside shallow/female end of channel. Manufactured from plastic with choice of black coated, stainless or galvanized steel end frame. Guides aid cutting to correct height. Seal using appropriate flexible sealant.



Outlet Cap

Fits outside deep/male end of all channels. Manufactured from plastic with choice of black coated, stainless or galvanized steel end rail. Guides aid cutting to correct height. Seal using appropriate flexible sealant. Bell end connection to fit 4", 6" or 8" SCH 40 pipes.

Note: For depth 801-804 channels ACO recommends removal of unused sections of the bell end to ensure adequate pavement material coverage.



Vertical Outlet Adapter

4", 6" or 8" SCH 40 vertical outlet adapter manufactured from plastic. Can be secured to underside of channel using appropriate flexible sealant to provide vertical bell end for easy attachment to 4", 6" or 8" SCH 40 pipe. Can be used anywhere along channel.



F660 & F880 Catch Basins

One piece fiberglass catch basins with choice of black coated, stainless or galvanized steel frame, lockable steel bar or ductile iron slotted grate and plastic trash bucket.

Accessories include 4", 6" and 8" SCH 40 pipe adapters and channel collars to connect channel to catch basin. See page 151 for details.

Channel Dimensions & Flow Rates

9' Channel

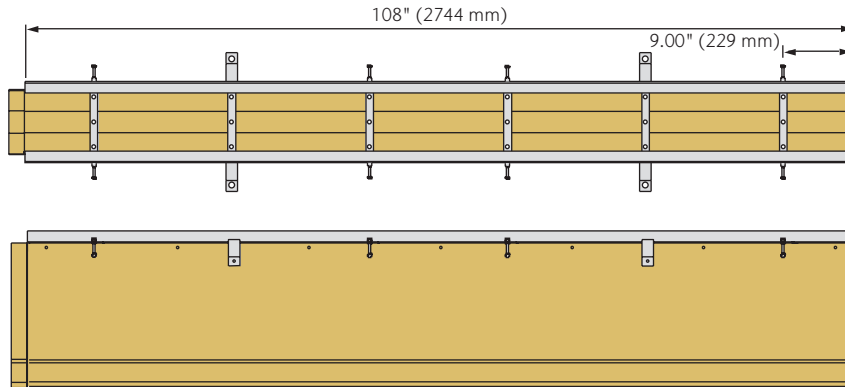

3' Channel

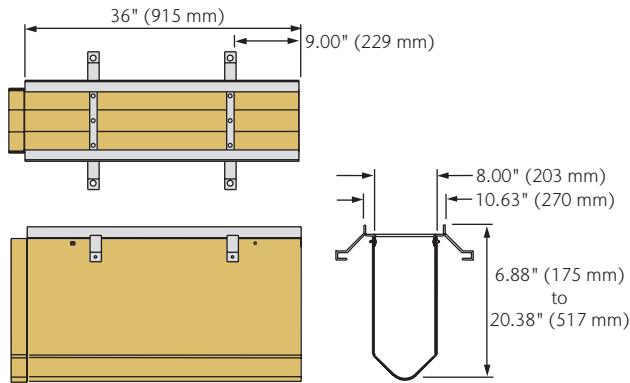

Vertical Outlet Adapter

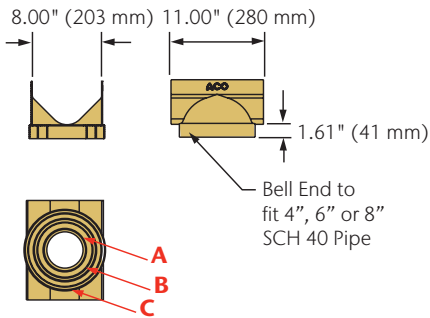

Male Closing Cap

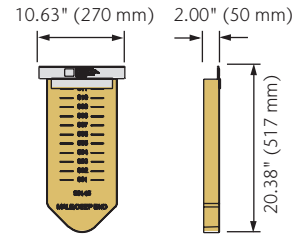

Female Closing Cap

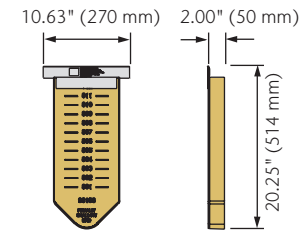

Outlet End Cap

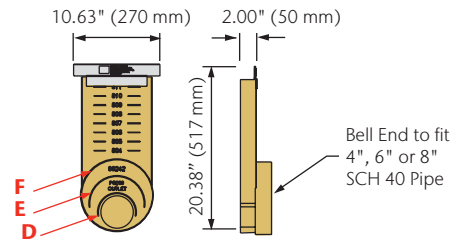

OUTLET FLOW RATES

Channel Outlet	Size (SCH 40)	Invert in	GPM	CFS
A	4" round	7.88	154	0.34
		20.25	246	0.54
B	6" round	7.88	346	0.77
		20.25	553	1.23
C	8" round	7.88	616	1.37
		20.25	982	2.18
D	4" round	9.00	145	0.33
		20.25	233	0.54
E	6" round	10.13	330	0.76
		20.25	510	1.17
F	8" round	12.38	635	1.46
		20.25	880	2.03

FG200 Parts

	Part No.	Invert Depth				Overall Depth				Volume gal	Weight lbs
		in		mm		in		mm			
		female	male	female	male	female	male	female	male		
F801 Sloped Channel - 108" (2.75 m)	99006	6.75	7.88	172	200	6.88	8.01	175	203	18.37	11.0
F802 Sloped Channel - 108" (2.75 m)	99013	7.88	9.00	200	229	8.01	9.13	203	232	22.58	12.0
F803 Sloped Channel - 108" (2.75 m)	99021	9.00	10.13	229	257	9.13	10.26	232	260	26.79	13.0
F803N Constant Depth Channel - 108" (2.75 m)	99048	10.13	10.13	257	257	10.26	10.26	260	260	28.80	15.5
F803N3 Constant Depth Channel - 36" (0.915 m)	99034	10.13	10.13	257	257	10.26	10.26	260	260	9.60	5.2
F804 Sloped Channel - 108" (2.75 m)	99055	10.13	11.25	257	286	10.26	11.38	260	289	31.00	14.1
F805 Sloped Channel - 108" (2.75 m)	99062	11.25	12.38	286	314	11.38	12.51	289	318	35.21	15.2
F806 Sloped Channel - 108" (2.75 m)	99071	12.38	13.50	314	343	12.51	13.63	318	346	39.42	16.3
F806N Constant Depth Channel - 108" (2.75 m)	99095	13.50	13.50	343	343	13.63	13.63	346	346	41.50	16.3
F806N3 Constant Depth Channel - 36" (0.915 m)	99084	13.50	13.50	343	343	13.63	13.63	346	346	13.83	5.5
F807 Sloped Channel - 108" (2.75 m)	99109	13.50	14.63	343	371	12.63	14.76	346	375	43.63	17.4
F808 Sloped Channel - 108" (2.75 m)	99116	14.63	15.75	371	400	14.76	15.88	375	403	47.84	18.5
F809 Sloped Channel - 108" (2.75 m)	99123	15.75	16.87	400	429	15.88	17.00	403	432	52.05	19.6
F809N Constant Depth Channel - 108" (2.75 m)	99145	16.87	16.87	429	429	17.00	17.00	432	432	54.10	19.6
F809N3 Constant Depth Channel - 36" (0.915 m)	99132	16.87	16.87	429	429	17.00	17.00	432	432	18.00	6.5
F810 Sloped Channel - 108" (2.75 m)	99156	16.87	18.00	429	457	17.00	18.13	432	460	56.26	20.7
F811 Sloped Channel - 108" (2.75 m)	99162	18.00	19.13	457	486	18.13	19.26	460	489	60.47	21.8
F812 Sloped Channel - 108" (2.75 m)	99175	19.13	20.25	486	514	19.26	20.38	489	518	64.68	23.0
F812N Constant Depth Channel - 108" (2.75 m)	99192	20.25	20.25	514	514	20.38	20.38	518	518	66.76	23.0
F812N3 Constant Depth Channel - 36" (0.915 m)	99186	20.25	20.25	514	514	20.38	20.38	518	518	22.25	7.7
Black-coated Steel Frame - 108" (2.75 m)	97066	-	-	-	-	-	-	-	-	-	57.9
Black-coated Steel Frame - 36" (0.915 m)	98524	-	-	-	-	-	-	-	-	-	19.3
Galvanized Steel Frame - 108" (2.75 m)	97079	-	-	-	-	-	-	-	-	-	57.9
Galvanized Steel Frame - 36" (0.915 m)	98538	-	-	-	-	-	-	-	-	-	19.3
Stainless Steel Frame - 108" (2.75 m)*	97087	-	-	-	-	-	-	-	-	-	57.9
Stainless Steel Frame - 36" (0.915 m)*	98545	-	-	-	-	-	-	-	-	-	19.3
Closing Cap (female) with Black End Frame	98365	-	-	-	-	20.38	20.38	518	518	-	1.1
Closing Cap (female) with Galvanized Steel End Frame	98386	-	-	-	-	20.38	20.38	518	518	-	1.1
Closing Cap (female) with Stainless Steel End Frame	98375	-	-	-	-	20.38	20.38	518	518	-	1.1
Closing Cap (male) with Black End Frame	98363	-	-	-	-	20.38	20.38	518	518	-	1.3
Closing Cap (male) with Galvanized Steel End Frame	98382	-	-	-	-	20.38	20.38	518	518	-	1.3
Closing Cap (male) with Stainless Steel End Frame	98372	-	-	-	-	20.38	20.38	518	518	-	1.3
Outlet Cap (male) with Black End Frame	98361	20.25	20.25	514	514	20.38	20.38	518	518	-	1.8
Outlet Cap (male) with Galvanized Steel End Frame	98381	20.25	20.25	514	514	20.38	20.38	518	518	-	1.8
Outlet Cap (male) with Stainless Steel End Frame	98373	20.25	20.25	514	514	20.38	20.38	518	518	-	1.8
Vertical Outlet Adapter - 4", 6" or 8" Outlet	98103	20.25	20.25	514	514	20.38	20.38	518	518	-	1.6

Notes

1. Invert depths are for the channel body & frame assembled.
 2. Channel weights are for fiberglass body only.
 3. Closing/Outlet caps can be cut down to suit all channels.
 4. Add 2" to length of each channel for female joining flange (only applicable at shallowest end of trench run).
 5. Frames supplied with plastic snap-fit studs for connecting to fiberglass body.
 6. See page 155 for grate details.
 7. See Catch Basin Parts List on page 151.
- * Grade 304 stainless steel frames, ACO recommends the use of non-galvanized grates with stainless steel frames to avoid galvanic corrosion.

Fiberglass Catch Basins

Fiberglass catch basins are available with a variety of frames and grates. Channel collars are available to connect all depths of channel on any side of the catch basin.

Pipe adapters are available to allow inlet/outlet pipe connections at any position on the catch basin.

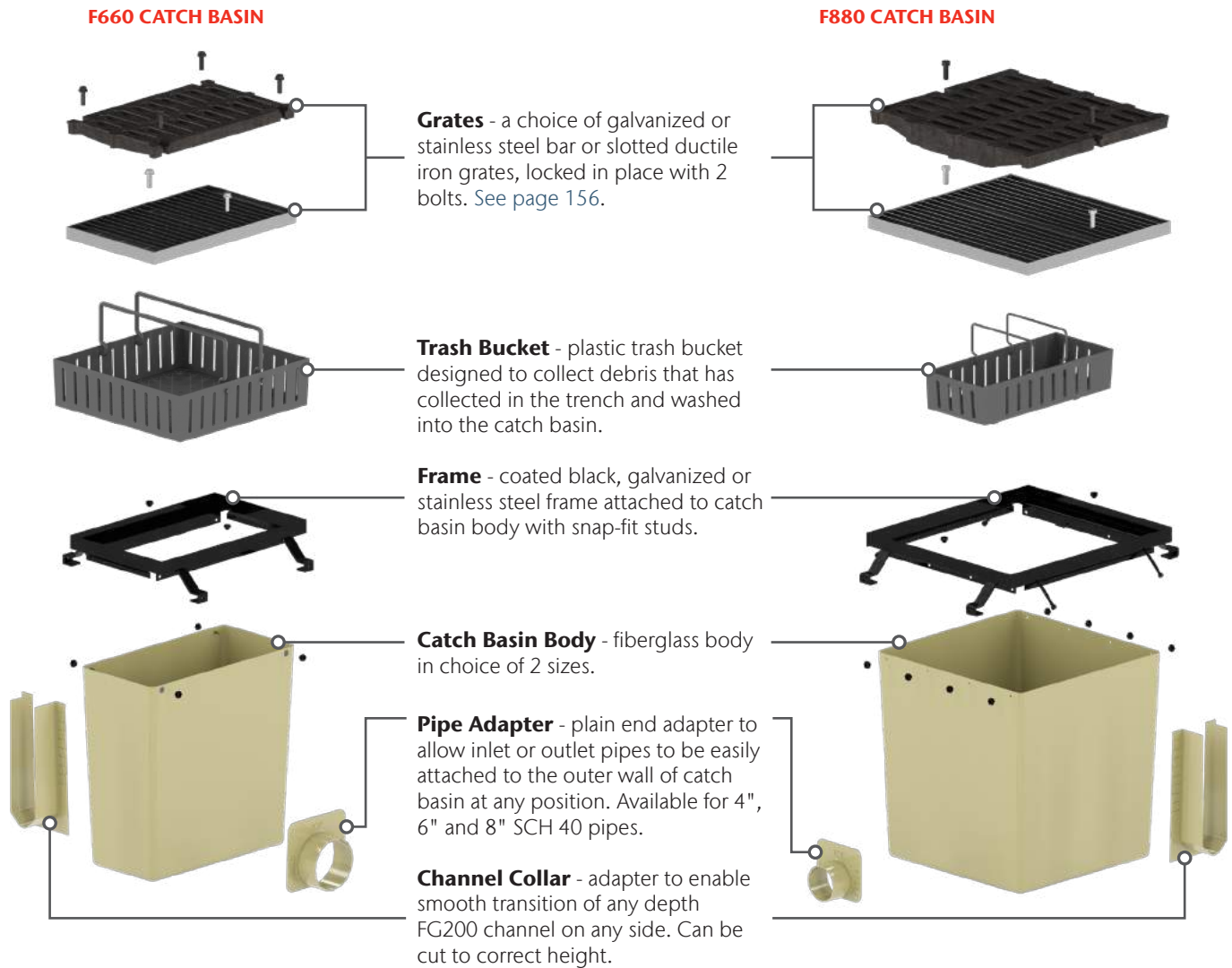

FG200 Catch Basin Parts

	Part No.	Volume gal	Weight lbs
F660 Catch Basin - 24" x 12"	98069	27.00	22.0
F660 Black-coated Steel Frame	97995	-	13.8
F660 Galvanized Steel Frame	98008	-	14.4
F660 Stainless Steel Frame*	98013	-	14.4
F660 Plastic Trash Bucket	98067	-	5.0
F880 Catch Basin - 24" x 24"	98075	55.00	22.0
F880 Black-coated Steel Frame	98021	-	23.2
F880 Galvanized Steel Frame	98034	-	24.2
F880 Stainless Steel Frame*	98048	-	24.2
F880 Plastic Trash Bucket	98059	-	8.4
FG200 Channel/Catch Basin Adapter	98171	-	1.1
4" Pipe Plain End Adapter	97425	-	0.4
6" Pipe Plain End Adapter	97438	-	0.6
8" Pipe Plain End Adapter	97444	-	0.9

*Grade 304 Stainless Steel Frames.

ACO recommends use of non-galvanized grates with Stainless Steel Frames to avoid galvanic corrosion.

Catch Basin Dimensions & Flow Rates

F660 Catch Basin

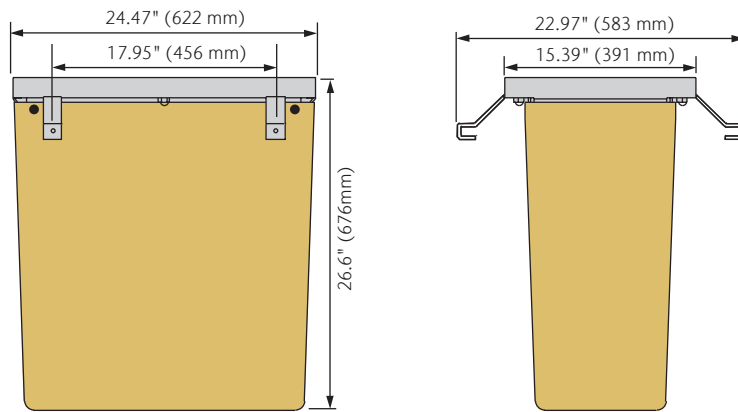

Pipe Adapter

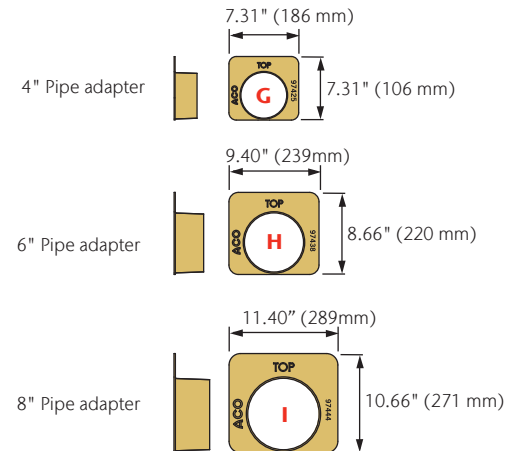

F880 Catch Basin

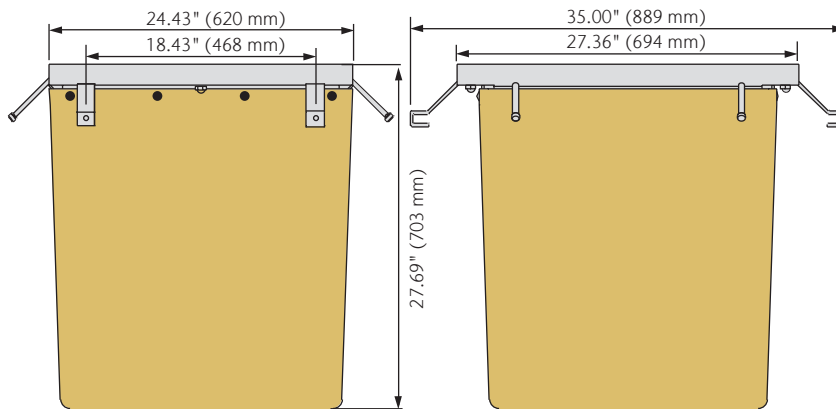

Channel Collar

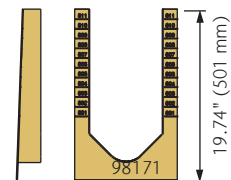

Catch Basin Outlet	Size (SCH 40)	F660			F880		
		Invert in	GPM	CFS	Invert in	GPM	CFS
G	4" round	26.50	269	0.60	27.50	275	0.61
H	6" round	26.50	594	1.32	27.50	606	1.35
I	8" round	26.50	1,032	2.30	27.50	1,055	2.35

Note: These are pipe flow rates at specified outlet—NOT channel flow rates—and are assuming that pipe adapter is fitted at lowest level on catch basin. Catch Basin flow rates without trash bucket - using trash bucket reduces flow.





MCCARRAN INTERNATIONAL AIRPORT

Las Vegas, NV
United States

Built in 1942, McCarran International Airport is the main government airport for public use in the Las Vegas Valley and is the busiest airport in the United States that does not operate as a carrier hub.

Airports require prompt removal of surface water and need to have many locations of integrated drainage. 513' of FG200's lightweight fiberglass bodies and Ductile Iron bolted grates made the perfect solution.

PORTFOLIO

FG200 Grates - Bolted

KEY



ADA Compliant
Compliant with Americans with Disabilities Act of 2010, Section 302.3 (page 174)



Heel-Resistant
ASME A112.6.3 - 2001 Heel-resistant slot width less than 0.31" (8 mm) (page 174)



Heel-Safe
Heel-safe slot width equal or less than 0.25" (6.5 mm) (page 174)



Slip-Resistant Grates
BPN over 24 (page 174)



Bicycle-Safe
Compliant to Australian Standard AS 3996 - 2006 (page 174)



Non-Metallic
No metallic/magnetic parts included (page 170)

For details on how psi is determined, see pages 161-166.

	Part No.	Length in (m)	Slot Size in	Intake Area in ²	Weight lbs					
LOAD CLASS C (EN 1433) - 56,202 LBS - 967 PSI (COMMERCIAL VEHICLE TRAFFIC)										
BAR STEEL										
	Galvanized ³	36.00 (0.9)		264.0	28.6					
			1.0 x 3.6			✓	✗	✗	✗	✗
	Stainless ^{1,2}	36.00 (0.9)		264.0	28.6					
LOAD CLASS E (EN 1433) - 134,885 LBS - 2,321 PSI (INDUSTRIAL TRAFFIC)										
SLOTTED IRON^{2,5}										
	Iron	18.00 (0.45)	0.61 x 7.87	58.7	25.2	✓	✗	✗	✗	✗
LONGITUDINAL IRON^{2,5}										
	Iron	18.00 (0.45)	1.75 x 0.25	35.0	28.2	✓	✓	✓	✓	✓

4-BOLT GRATE LOCKING

Bolted FG200 grates offer mechanical, secure fixing of grates into the channel frame. Two bolts per 18" grate section lock into cross bars in the steel frame. Care must be taken to ensure that all bolts are secure and are not overtightened which can damage the frame.



1 Fit grate

Position grate onto channel, align holes in grate with matching holes in edge rail.



2 Fit grate















Use wrench or socket set to tighten. If using a torque wrench, do not set to more than 15 ft. lbs.



3 Remove grate

To remove grates, use wrench or socket set. Carefully store bolts for refitting of grates. Tamper-resistant bolts require a tamper-resistant drive bit.





F660 Grates - Bolted

Part No.	Length in (m)	Slot Size in	Intake		    	
			Area in ²	Weight lbs		
LOAD CLASS C (EN 1433) - 56,202 LBS - 739 PSI (COMMERCIAL VEHICLE TRAFFIC)						
BAR STEEL						
Galvanized ³	97443	24.00 (0.6)	1.0 x 3.3	267.0	35.2	    
				✓	x	
Stainless ^{1,4}	97442	19.69 (0.5)	1.0 x 3.3	267.0	35.2	    
				✓	x	



LOAD CLASS C (EN 1433) - 56,202 LBS - 739 PSI (COMMERCIAL VEHICLE TRAFFIC)



BAR STEEL

Galvanized ³	97443	24.00 (0.6)	1.0 x 3.3	267.0	35.2	    
				✓	x	
Stainless ^{1,4}	97442	19.69 (0.5)	1.0 x 3.3	267.0	35.2	    
				✓	x	

















LOAD CLASS E (EN 1433) - 134,885 LBS - 1,773 PSI (INDUSTRIAL TRAFFIC)

SLOTTED IRON^{2,5}

Iron	97449	24.00 (0.6)	1.2 x 6.1 avg.	130.0	75.0	    
------	-------	-------------	----------------	-------	------	---











F880 Grates - Bolted

Part No.	Length in (m)	Slot Size in	Intake		    	
			Area in ²	Weight lbs		
LOAD CLASS C (EN 1433) - 56,202 LBS - 739 PSI (COMMERCIAL VEHICLE TRAFFIC)						
BAR STEEL						
Galvanized ³	97452	24.00 (0.6)	1.0 x 3.3	456.0	63.8	    
				✓	x	
Stainless ^{1,4}	97455	24.00 (0.6)	1.0 x 3.3	456.0	63.8	    
				✓	x	



LOAD CLASS C (EN 1433) - 56,202 LBS - 739 PSI (COMMERCIAL VEHICLE TRAFFIC)





BAR STEEL

Galvanized ³	97452	24.00 (0.6)	1.0 x 3.3	456.0	63.8	    
				✓	x	
Stainless ^{1,4}	97455	24.00 (0.6)	1.0 x 3.3	456.0	63.8	    
				✓	x	



LOAD CLASS E (EN 1433) - 134,885 LBS - 1,773 PSI (INDUSTRIAL TRAFFIC)

SLOTTED IRON^{2,5}

Iron	97453	24.00 (0.6)	1.2 x 5.5 avg.	226.0	206.0	    
------	-------	-------------	----------------	-------	-------	---

Notes

- Grade 304 stainless steel
- Ductile iron to ASTM A536 Grade 80-55-06.
- Supplied with 4 galvanized steel socket head bolts (1/2" - 13 x 1 1/2") - replacement part no. 93895.
- Supplied with 4 stainless steel socket head bolts (1/2" - 13 x 1 1/2") - replacement part no. 93897.
- Supplied with 2 stainless steel hex head bolts (1/2" - 13 x 1 1/2") - replacement part no. 93892.