



www.acudor.com  
 U.S.A.: info@acudor.com / 800.722.0501  
 CANADA: info@acudor.ca / 844.228.3671  
 INTERNATIONAL: info@acudorintl.com  
 905.428.2240

**FRFD**

**FIRE RATED FLOOR DOOR**

NOMINAL DOOR SIZE	FRAME OPENING		CLEAR OPENING		OVERALL SIZE		WEIGHT
in. (mm)	A in. (mm)	B in. (mm)	C in. (mm)	D in. (mm)	E in. (mm)	F in. (mm)	LBS. (KG)
24 x 24 (610 x 610)	24 (610)	24 (610)	20 (508)	24 (610)	34 (864)	34 (864)	80 (36)
24 x 36 (610 x 914)	24 (610)	36 (914)	20 (508)	36 (914)	34 (864)	46 (1168)	140 (63)
24 x 48 (610 x 1219)	24 (610)	48 (1219)	20 (508)	48 (1219)	34 (864)	58 (1321)	160 (73)
30 x 30 (762 x 762)	30 (762)	30 (762)	26 (660)	30 (762)	40 (1016)	40 (1016)	130 (59)
30 x 36 (762 x 914)	30 (762)	36 (914)	26 (660)	36 (914)	40 (1016)	46 (1168)	160 (73)
36 x 36 (914 x 914)	36 (914)	36 (914)	32 (813)	36 (914)	46 (1168)	46 (1168)	190 (86)
36 x 48 (914 x 1219)	36 (914)	48 (1219)	32 (813)	48 (1219)	46 (1168)	58 (1473)	240 (109)
42 x 42 (1067 x 1067)	42 (1067)	42 (1067)	38 (965)	42 (1067)	52 (1321)	52 (1321)	250 (113)
48 x 48 (1219 x 1219)	48 (1219)	48 (1219)	44 (1118)	48 (1219)	58 (1473)	58 (1473)	280 (127)

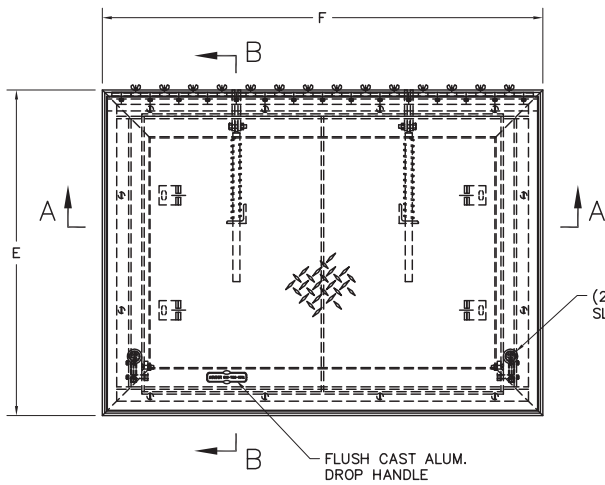

**PLAN VIEW OF HATCH**  
 (INSULATION PAN NOT SHOWN FOR CLARITY)

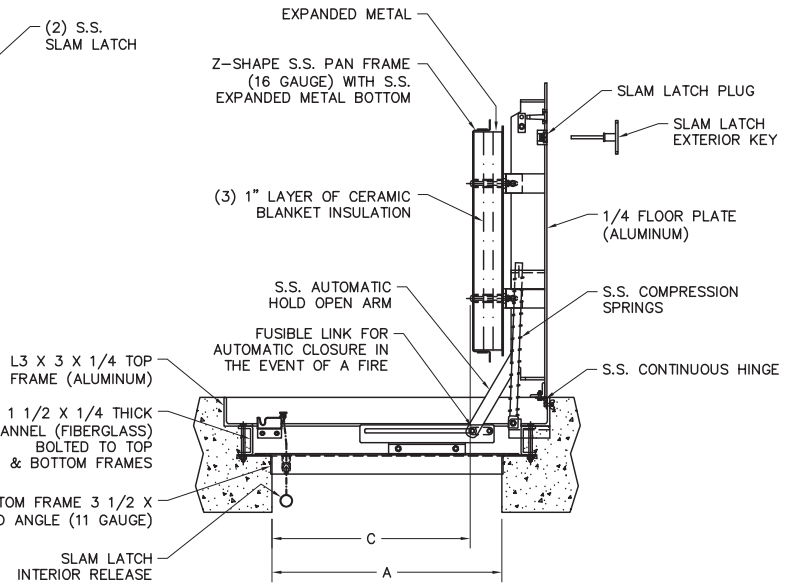

**SECTION B-B**  
 (WITH DOOR OPEN)

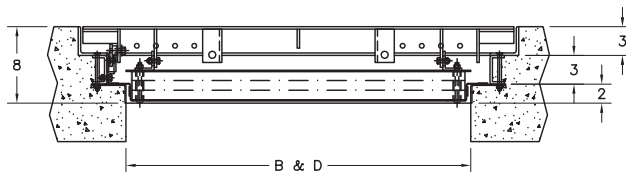

**SECTION A-A**

- NOTES:**
- 1- MATERIAL: ALUMINUM & ST. STEEL
  - 2- LOADING: 150 LBS. PER SQ. FT.
  - 3- 316 STAINLESS STEEL NUTS & BOLTS
  - 4- CERTIFIED 2-HOUR FIRE RATING

JOB NAME:  
 CUSTOMER:

APPROVED BY:  
 DATE: