

# **SANITITE® HP PIPE** **SANITARY INSTALLATION GUIDE**



The Most **Advanced** Name in Drainage Systems®



## Introduction

Both polypropylene (PP) and corrugated high density polyethylene (HDPE) pipes are available for a variety of applications. These applications include gravity flow sanitary and storm sewer, low head pressure applications as well as many others as deemed appropriate by the design engineer. This installation pocket guide is intended to provide guidance on typical installation requirements for ADS plastic pipe used for sanitary sewer. Product specific exception to this pocket guide in the area of acceptable backfill, fill heights, joint connections and other product specific information may be found by referencing the appendix for additional resources.

## Table of Contents

<b>Job Site Handling and Receiving .....</b>	<b>5</b>
<b>Job Site Pipe Storage .....</b>	<b>7</b>
<b>Trench Construction .....</b>	<b>8</b>
<b>Trench Boxes .....</b>	<b>10</b>
<b>Bell &amp; Spigot Joint Assembly .....</b>	<b>12</b>
• Bar & Block Method .....	13
• Backhoe Method .....	14
• Backhoe and Sling Method .....	14
<b>Installation Stub Fabrication .....</b>	<b>15</b>
<b>Joining Different Pipe Types or Sizes .....</b>	<b>16</b>
<b>Manholes and Catch Basin/ Connections .....</b>	<b>17</b>
<b>Field Gasket Assembly .....</b>	<b>19</b>
<b>Fittings Assembly .....</b>	<b>20</b>
<b>Backfill Recommendations .....</b>	<b>22</b>
• Backfill Material Selection .....	22
• Groundwater or Surface Runoff .....	24
• Backfill Envelope Construction .....	24

## Table of Contents

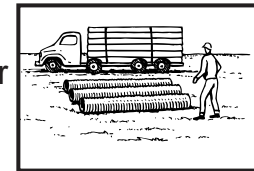
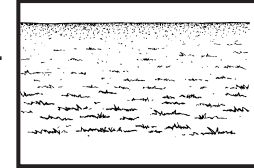
<b>Other Installation Considerations</b> .....	26
• Construction and Paving Traffic .....	26
• Maximum Cover .....	27
• Vertical Installations .....	29
• Flotation.....	30
• Bending Radius.....	31
• Service Connections .....	32
• Thrust Restraint.....	32
<b>Repair Methods</b> .....	33
• Watertight:	
– Option 1: PVC Slip Coupling.....	33
– Option 2: External Coupling .....	34
– Option 3: Concrete Collar.....	34
– Option 4: Chemical Grouting.....	35
– Option 5: Internal Sealing .....	35
<b>Recommendations for</b>	
<b>In-Field Testing</b> .....	36
• Leakage Testing .....	36
• Deflection Testing.....	36
<b>Appendix</b> .....	38

## Job Site Handling and Receiving

### Receiving Recommendations

Our distributors and customer service personnel make service and customer satisfaction their highest priority. If your order is incorrect, contact your distributor or our customer service personnel.

- Direct driver to a smooth, flat area, free of rocks and debris.
- Examine load quantities and quality immediately after unloading. Inspect pipe carefully for possible damage from transportation or unloading.
- Note damaged or missing items on delivery receipt.
- Shortages and damaged material are not automatically reshipped. Reorder replacement material.
- Do not dispose of damaged items. Check with driver for proper return method. If driver is unsure, contact our customer service personnel.

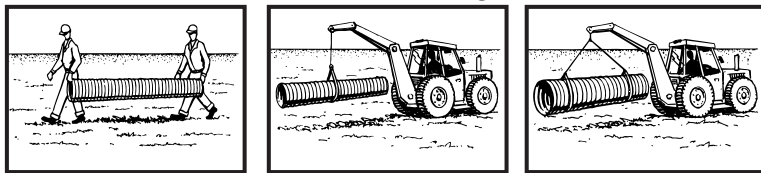


### Handling Recommendations

To avoid damage to the pipe and fittings the following handling recommendations should be followed:

- OSHA safety requirements.
- Do not drop pipe.
- 18" (450 mm) and smaller pipe can be moved by hand. Larger pipe requires a backhoe with a nylon sling.

- Lift 36" (900 mm) and larger diameter pipe with a sling at two points, spaced approximately 10 feet (3 m) apart. Smaller diameters can use one lift point. Refer to Table 1 for recommended handling methods.



≤18" (450 mm)      24"-30" (600-750 mm)      ≥36" (900 mm)

- Contractor assistance is required to unload palletized pipe.
- Do not use a loading boom or forklift directly on or inside pipe.

**Table 1:**

Recommended Pipe Handling Method		
Diameter in. (mm)	Approx. weight lb/ft (kg/m)	Handling Method*
12 (300)	3.6 (5.4)	Labor
15 (375)	5.3 (7.9)	Labor
18 (450)	7.1 (10.5)	Labor
24 (600)	11.9 (17.7)	Sling (1 point)
30 (750)	18.3 (27.3)	Sling (1 point)
36 (900)	24.3 (36.1)	Sling (2 points)
42 (1050)	30.0 (44.7)	Sling (2 points)
48 (1200)	41.9 (62.4)	Sling (2 points)
60 (1500)	57.3 (85.4)	Sling (2 points)

\*Recommended handling methods are based on two laborers per pipe length, neither of which is carrying more than 100 lb. (45 kg).

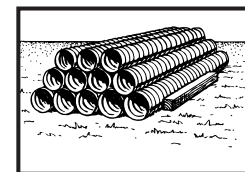
## Job Site Pipe Storage

### Storage Recommendations

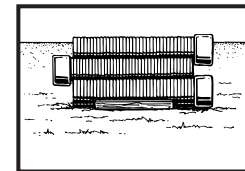
To ensure that your delivered pipe products do not become damaged during job site storage, follow these simple guidelines:

- Non-palletized pipe may be temporarily stockpiled on a flat, clear area.
- Use securing timbers (or blocks) to ensure the stockpile does not collapse.
- Failure to block pipe may result in stack collapsing, pipe damage, or personal injury.

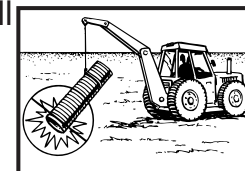
- Stack pipe no higher than approximately 6 feet (1.8 m).



- While supporting lengths of pipe evenly, alternate bells for each row of pipe.



- To prevent damage to the bell or spigot when moving pipe sections, do not drag or strike pipe ends against anything.



## Trench Construction

- Information provided in this pocket installation guide is intended as a quick reference only and does not supersede requirements specified on project plans.
- The trench or ditch should be wide enough to place and compact backfill around the entire pipe.
- Refer to Table 2 for recommended minimum trench widths. The design engineer may modify the trench width based on site specific conditions.

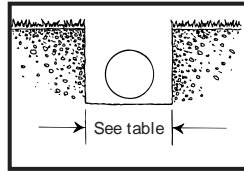
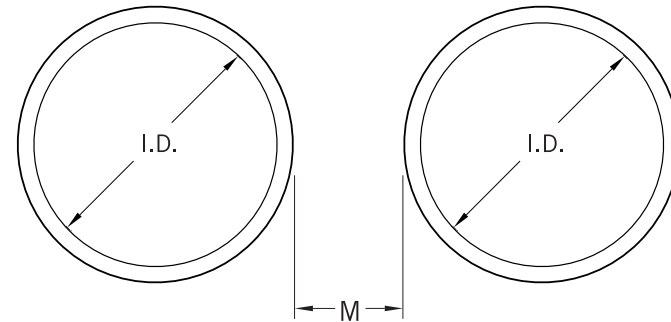


Table 2:

Minimum Trench Widths	
Pipe Diameter in. (mm)	Trench Width in. (m)
12 (300)	30 (0.8)
15 (375)	34 (0.9)
18 (450)	39 (1.0)
24 (600)	48 (1.2)
30 (750)	56 (1.4)
36 (900)	64 (1.6)
42 (1050)	72 (1.8)
48 (1200)	80 (2.0)
60 (1500)	96 (2.4)

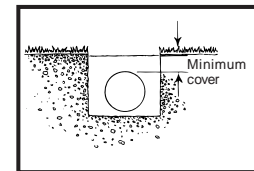
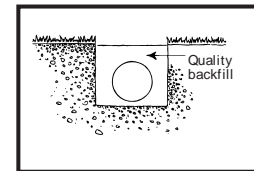
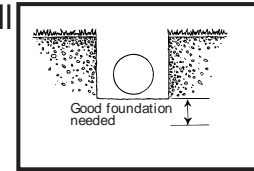
- For parallel pipe installations, allow space between pipes for proper compaction. Refer to Figure 1 for minimum pipe spacing.

## Figure 1: Parallel Pipe Installation



UP TO 24" (600MM) I.D.: M=12" (300MM)  
 MORE THAN 24" (600MM) I.D.: M=1/2 I.D.

- Trench or ditch bottoms containing bedrock, soft muck or refuse, or other material unable to provide long-term uniform pipe support are **unacceptable**.
- All unsuitable foundation shall be excavated before pipe installation proceeds.
- Where the trench bottom is unstable, the contractor shall excavate to a depth required by the engineer and replace with suitable material as is specified by the engineer.
- If native soil can migrate into backfill, use synthetic fabric (geotextile) to separate native soil from backfill.



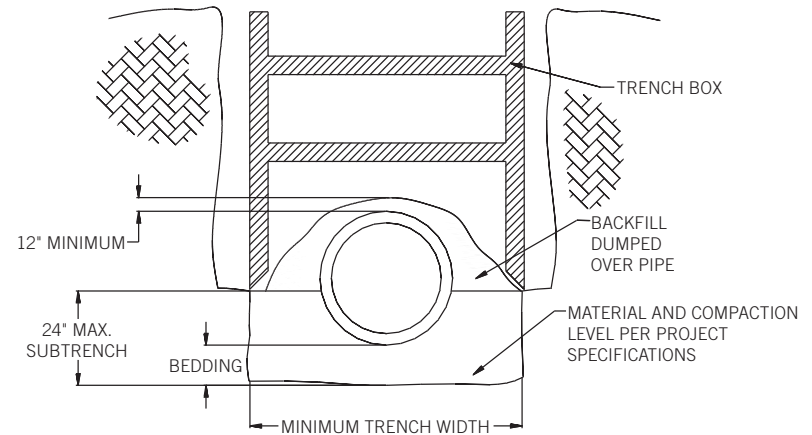
## Trench Boxes

Trench boxes provide a safe work area to install pipe in deep trenches or in soils that have insufficient stability. **Always** follow OSHA requirements when using a trench box.

The length of the trench box should be suitable for the pipe length. Nominal length for pipe is 20 ft. (6.1 m) although shorter lengths can be supplied.

The most effective way to maintain a sound system is to provide a 'subtrench' within which to place the pipe and backfill. The subtrench shall not be greater than 24" above the bottom on the trench as shown in Figure 2. Backfill and compact according to the design specifications within the subtrench. The trench box can be pulled along the top edge of the subtrench without affecting the backfill in the pipe embedment zone.

Figure 2: Subtrench Installation

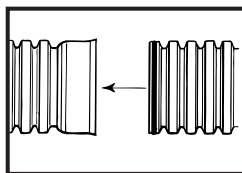
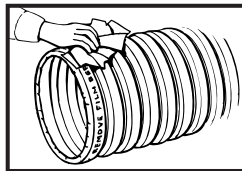
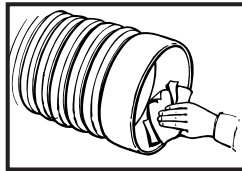


In installations not involving a subtrench, dragging a trench box should only be done if it does not damage the pipe or disrupt the backfill; otherwise, the box should be lifted vertically into its new position, again taking great care not to disturb the pipe or backfill.

## Bell & Spigot Joint Assembly

For pipe with a bell-and-spigot connection, it is imperative that the joint be assembled properly to ensure that the product performs to expectations. The steps that must be followed to obtain a quality joint are provided below. Failure to follow these instructions may cause the joint quality to be severely compromised.

- Lower pipe into trench by hand, or use nylon straps and excavating equipment.
- Begin by inspecting the bell and remove any foreign matter.
- Use a clean rag or brush to lubricate bell of pipe lubricant.
- Clean spigot end of pipe.
- Remove protective wrap from gaskets.
- Using clean rag or brush, lubricate exposed gaskets with pipe lubricant.
- Do not allow lubricated section to touch dirt or backfill. Foreign matter could adhere to surface and compromise joint integrity.



- Place spigot into bell and align.

Note: It is recommended that one always lay pipe starting at the down stream end, pushing spigots into bells with the bells facing upstream. Always push spigot ends into bell, **not** bell end into spigot.

Assemble joint using one of the following methods. (For smaller diameters, pipe may be joined manually.)

- For all methods, ensure bell and spigot are adequately “homed” for proper installation and tight joining seal. If no homing mark is present, measure the depth of the bell and use a crayon or other material to place a homing mark on appropriate corrugation of the spigot end.
- Installation stubs, mentioned in the assembly instructions, can be purchased or made following the information on page 15.
- Some high joint performance applications may require the joint to be held in place for a short time, immediately after insertion, to properly set the gasket.

## Bar & Block Method

- Place installation stub into bell end of pipe.
- Place wooden block horizontally across end of installation stub.
- With a bar, push against wooden block until pipe is fully inserted into bell.

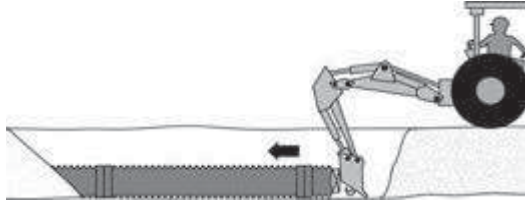


NOTE: This method requires use of installation stub. DO NOT push directly against pipe.



## Backhoe Method

- Place installation stub into bell end of pipe.
- Place wooden block horizontally across installation stub.

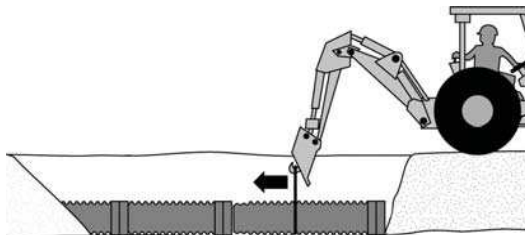


NOTE: This method requires use of installation stub. DO NOT push backhoe directly against pipe.

- Carefully push back of backhoe bucket against block until pipe is fully inserted into bell.

## Backhoe and Sling Method

- Wrap nylon sling around pipe. Pipe 36" (900 mm) or larger should be picked up at two points approximately 10' (3 m) apart.
- Hook other end of nylon sling to backhoe bucket.

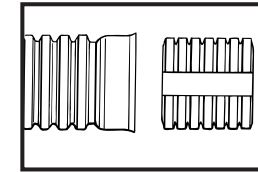


NOTE: Distance from bedding to bottom of pipe not to exceed 6" (150 mm) for a 20' (6 m) pipe.

- Operator should carefully push strap tight toward bell of downstream pipe until spigot is fully inserted into bell.
- Ensure pipe slides **squarely** into bell to avoid misalignment.
- **Keep pipe level.**
- **Where pipe is not kept level, joint integrity may be compromised.**

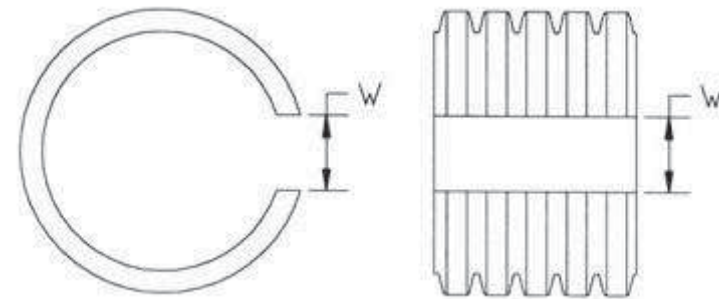
## Installation Stub Fabrication

To push "home" bell-and-spigot pipe, an installation stub can be used to prevent accidental damage to the bell. Installation stubs are not required if the bell is not pushed on directly. Installation stubs in all sizes are available from your distributor, or you can fabricate your own on site by following the proceeding steps:



- Cut a section of pipe five corrugations long in the center of the corrugation valley.
- Using a saw, remove a strip of pipe wall from the short stub of pipe (Figure 3). Note: Strip width depends on pipe size. See Table 3 for recommended widths.

Figure 3: Installation Stub



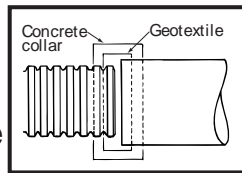
**Table 3:**

Strip Width for Installation Stub	
Diameter in. (mm)	Width in. (mm)
12 (300)	4 (102)
15 (375)	5 (127)
18 (450)	6 (152)
24 (600)	7.5 (191)
30-42 (750-1050)	10 (254)
48-60 (1200-1500)	12 (305)

- To use stub, push on pipe walls to change O.D. of stub to I.D. of bell to be installed.

### Joining Different Pipe Types or Sizes

In some cases, connecting pipes of different materials or sizes is required. Options to make these transitions are often limited by the joint quality required. One very common method of connecting different types of pipe of the same size, and in some cases different sizes, is through the use of a concrete collar. This generally provides a minimum silt-tight joint quality but the resulting quality ultimately depends on workmanship.



- A concrete collar is formed by butting the two pipe ends tightly together, wrapping the junction with a geotextile to keep out most soil and concrete, and then pouring a concrete collar that covers both pipe ends.

Another option may be using fittings or adapters specifically designed for this application. A selection of fittings designed to make the transition from one material directly to another is available. In other cases a fitting may need to be used in combination with another manufacturer's gasket or coupler to complete the transition. Transitions made in this manner may provide for a higher performance joint than a concrete collar.

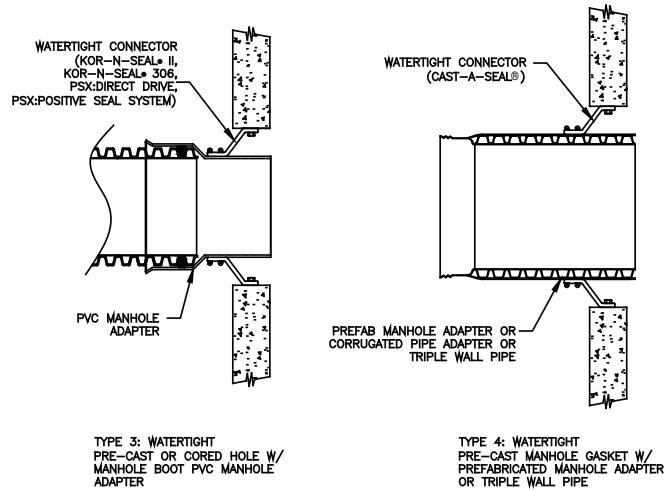
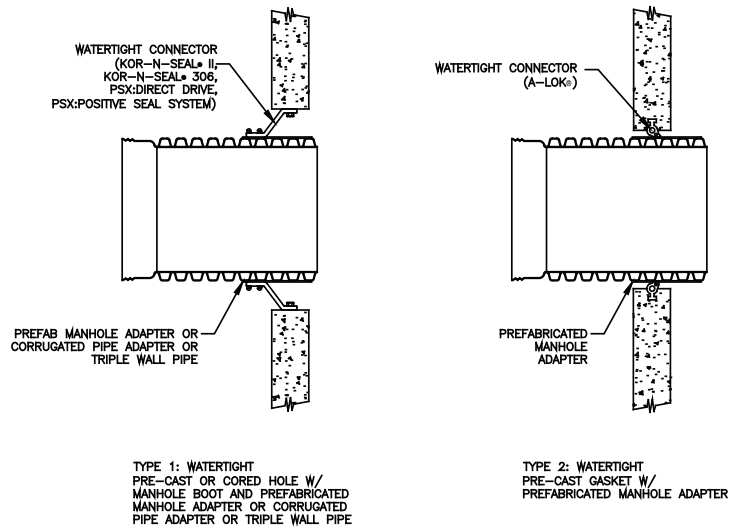
### Manholes and Catch Basin/Connections

Manholes or catch basins can be used at changes in pipe material, size, grade, direction and elevation. Manholes and catch basins can be more costly than other alternatives but also allow grade and directional changes in addition to changes in pipe material and size.

- Local regulations should be consulted to determine if manholes or catch basins are required at any or all pipe changes.
- Refer to Figure 4 for the acceptable methods of connecting plastic pipe to manholes or basins.
- See appendix for references to additional product specific resources applicable to connecting pipe to manholes.

Figure 4:

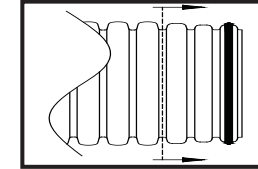
## Product Detail for Manhole Connections



## Field Gasket Assembly

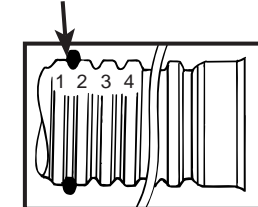
When standard lengths of pipe must be cut to fit in a field application, the following instructions will ensure proper performing joints:

*Note: Some fittings will use an integral bell and spigot that can connect directly to the pipe. Check fitting and pipe compatibility before cutting.*



- For reduced spigot pipe ONLY, reducing spigot must be removed.
- Using a saw, cut in the center of the valley of the first full corrugation.
- Trim remaining plastic burrs from saw cut. *Note: Failure to smoothly trim burrs may compromise joint integrity.*
- Wipe clean first valley from end of pipe. *This is where gasket will be placed.*
- Hold gasket with both hands so printing is facing you.
- With printing on gasket face-up and toward spigot end of pipe, slide gasket into first corrugation valley, starting at bottom. *Note: It is easier to pull gasket up to conform to valley.*
- Slide gasket into first corrugation valley by hand.
- Ensure printing on gasket is face-up and toward spigot end of pipe.
- Vent tubes shall be appropriately scaled at joint where applicable, see *Technical Note 5.16: Sealing Methods for Vent Tubes.*

*Gasket printing should be visible in this location when properly installed.*



## Fittings Assembly

This section includes information necessary for:

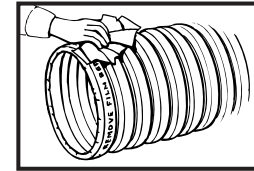
1. Watertight fittings
2. Repair couplers

*Note: Some fittings will use an integral bell and spigot that can connect directly to the pipe.*

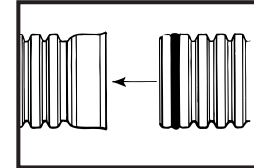
*Check fitting and pipe compatibility before cutting.*

- Cut pipe to desired length in the center of the corrugation valley before placing in trench.
- Trim remaining polyethylene burrs from saw cut. Note: Failure to smoothly trim burrs may compromise joint integrity.
- Excavate bedding from around spigot end where fitting shall be used. A bell hole will help prevent dirt and debris from contaminating joint during assembly.
- Install gasket in accordance with gasket assembly procedure (page 19).
- Measure the depth of the bell and use a crayon or other material to place a homing mark on appropriate corrugation of the spigot end.
- Vent tubes shall be appropriately sealed at joint where applicable, see *Technical Note 5.16: Sealing Methods for Vent Tubes*.

- Using clean rag or brush, lubricate exposed gasket with pipe lubricant.



- Do not let lubricated section touch dirt or backfill, as foreign material could adhere to surface and compromise joint integrity.
- Inspect fitting and remove any foreign matter.
- Align and center pipe.
- Lubricate inside of bell.
- Align fitting with pipe end.
- Use installation stub or blocking where required.
- Take care not to damage pipe or fittings.
- Ensure pipe is straight and bell reaches homing mark.
- Assemble other end of pipe or fitting as described in the pipe assembly section on page 12.
- Special care should be taken to replace and compact bedding material in bell hole to provide adequate support under the joint.

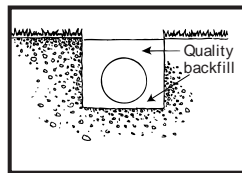
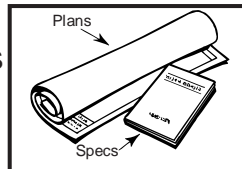


## Backfill Recommendations

Plastic pipe and a well-constructed backfill envelope work together to support soil and traffic loads. Correct installation will ensure long-term trouble-free service for all types of pipe systems.

## Backfill Material Selection

- Provided the plans meet minimum recommendations as stated in Table 4, they should take precedence.
- Locally available materials may be acceptable for backfill use, but must meet one of the acceptable soil classifications outlined in Table 4.
- Some compaction effort should be taken with Class 1 materials where voids are eliminated by knifing under and around pipe or by some other technique.
- Sand/gravel mixes and other Class II materials must be compacted to a minimum of 90% standard Proctor density, respectively.
- Non-cohesive sand, inorganic silts, and gravelly, sandy or silty clays, and other Class III and IV materials are not permitted.
- Flowable fill is another acceptable backfill material. Misalignment or flotation may occur unless added precautions are taken, such as anchoring the pipe or pouring the flowable fill



in lifts.

- See appendix for references to additional product specific resources that may be used when installing corrugated plastic pipe.

**Table 4:**

Acceptable Backfill Material and Compaction Requirements				
Description	Soil Classifications			Minimum Standard Proctor Density %
	ASTM D2321	ASTM D2487	AASHTO M43	
Graded or crushed, crushed stone, gravel	Class I	-	5 56	Compacted
Well-graded sand, gravels and gravel/sand mixtures; poorly graded sand, gravels and gravel/sand mixtures; little or no fines	Class II	GW GP SW SP	57 6	90%

\* Layer heights should not exceed 1/2 the pipe diameter. Layer heights may also need to be reduced to accommodate compaction method.

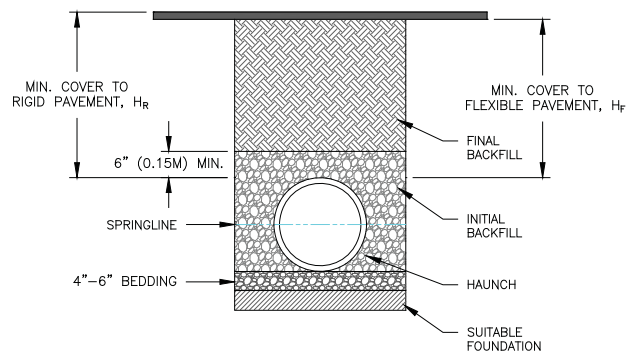
## Groundwater or Surface Runoff

When groundwater or surface runoff is present in the work area, dewater to maintain stability of native and imported materials. Maintain water level below pipe foundation to provide a stable trench bottom during pipe installation.


## Backfill Envelope Construction

- If native soil cannot carry load, import, compact and level adequate bedding material as in Figure 5.
- Figure 5 represents typical trench construction applicable to all products. See appendix for references to additional product specific resources.

Figure 5:



 FILL AS SPECIFIED BY DESIGN ENGINEER

 STRUCTURAL BACKFILL (COMPACTED CLASS I OR II MATERIAL)

$H_R, H_F = 12"$  FOR PIPE DIAMETERS UP TO 48"  
 $= 24"$  FOR PIPE DIAMETER 60"

TOTAL MINIMUM COVER INCLUDES 6" OF STRUCTURAL BACKFILL ABOVE THE PIPE CROWN AND THEN FINAL FILL

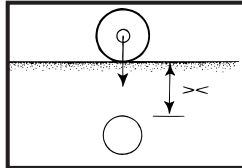
- Place and compact backfill in layers to meet requirements of Table 4 and project requirements. Note that the large diameter pipes may require layer heights less than those indicated in the table to achieve proper compaction.
- Avoid impacting pipe with compaction equipment.
- 12" - 48" (300-1200 mm) single pipe runs receiving H-25 traffic requires final backfill 6" (0.15 m) above initial backfill to provide at least 12" (0.3 m) of total cover as measured from the top of pipe to bottom of flexible pavement or to top of rigid pavement.
- 60" (1500 mm) single pipe runs receiving H-25 traffic require final backfill 18" (0.5 m) above initial backfill to provide at least 24" (0.6 m) of total cover as measured from top of the pipe to the bottom of flexible pavement or to top of rigid pavement.
- Minimum cover may be reduced in areas with no or infrequent light traffic. These situations must first be reviewed by the pipe manufacturer.

## Other Installation Considerations

All unique situations cannot be anticipated; however, several common questions are answered in the following material.

## Construction and Paving Traffic

- Some construction vehicles, such as many types of paving equipment, are not as heavy as the design load.
- For situations with relatively light construction vehicles, the 12" (0.3 m) and 24" (0.6 m) minimum covers criteria discussed earlier can be decreased during the construction phase.
- Table 5 presents the surface applied loads and the corresponding minimum cover that can be permitted on a temporary basis. *These criteria should only be employed during construction; finished projects should always have a minimum cover of at least 12" (0.3 m) for 12" - 48" (300-1200 mm) diameters and minimum cover of at least 24" (0.6 m) for 60" (1500 mm) diameters.*
- Vehicles exceeding these criteria must not be permitted to drive over the installation.*
- Areas receiving heavy construction equipment traffic between 30 and 60 tons require at least 3 feet (0.9 m) of cover. Higher loads require cover greater than 3 feet (0.9 m), depending on the load.
- If sufficient cover is not provided, mound and



compact material over pipe to provide minimum cover needed for load during construction.

- For heavy duty compaction equipment, such as a hoe-pack or equivalent type compactor, a minimum of 3 feet (0.9 m) of compacted backfill shall separate the pipe from the equipment.

**Table 5:**

Temporary Cover Requirements for Light Construction Traffic			
Type of Vehicle	Vehicular Load at Surface psi (kPa)	Temporary Minimum Cover, in. (mm) for:	
		12" - 48" (300-1200 mm) diameters	60" (1500 mm) diameters
Semi-tractor <sup>1</sup>	75 (517)	9 (230)	12 (300)
Loaded pick-up truck <sup>2</sup>	50 (345)	6 (150)	9 (230)
Skid steer loader <sup>3</sup>	25 (172)	3 (80)	6 (150)

1. Based on typical 3-axle day-trip tractor without trailer.

2. Chevy<sup>®</sup> 3500 series, fully loaded.

3. Bobcat<sup>®</sup> T180 model skid steer loader.

## Maximum Cover

The maximum burial depth is highly influenced by the type of backfill installed around the pipe. Maximum cover limits for SaniTite<sup>®</sup> HP pipe are shown in Table 6 for a variety of backfill conditions. Greater cover heights may be possible but should be reviewed by the Application Engineering Department.

**Table 6:**

Maximum Cover HP Pipe, ft (m)			
Diameter in (mm)	Class 1	Class 2	
	Compacted	95%	90%
12 (300)	40 (12.2)	28 (8.5)	21 (6.4)
15 (375)	42 (12.8)	29 (8.8)	22 (6.7)
18 (450)	37 (11.3)	26 (7.9)	19 (5.8)
24 (600)	32 (9.8)	23 (7.0)	17 (5.2)
30 (750)	32 (9.8)	23 (7.0)	17 (5.2)
36 (900)	29 (8.8)	21 (6.4)	15 (4.6)
48 (1200)	24 (7.3)	18 (5.4)	14 (4.3)
60 (1500)	30 (9.1)	22 (6.7)	16 (4.9)

**Notes:**

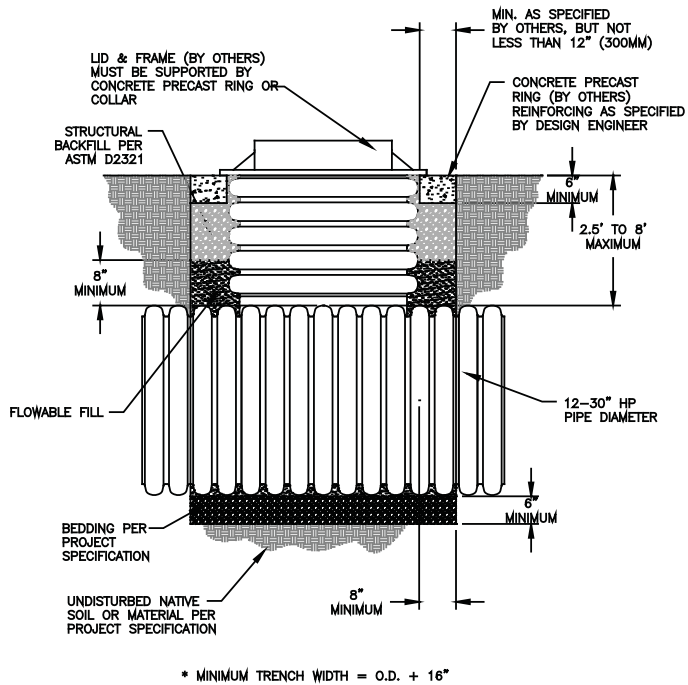
- 1) Results based on calculations shown in the Structures section of the Drainage Handbook. Calculations assume no hydrostatic pressure and a density of 120 pcf (1926 kg/m<sup>3</sup>) for overburden material. Contact manufacturer for fill height limits involving hydrostatic pressure.
- 2) Installation assumed to be in accordance with ASTM D2321 and the installation section of the Drainage Handbook.
- 3) Backfill materials and compaction levels not shown in the table may also be acceptable. Contact the manufacturer for further detail.
- 4) Material must be adequately "knifed" into haunch and in between corrugations. Compaction and backfill material is assumed uniform throughout entire backfill zone.
- 5) Compaction levels shown are for standard Proctor density.
- 6) For projects where cover exceeds the maximum values listed above, contact the manufacturer for specific design considerations.
- 7) Fill height table is applicable to product manufactured to ASTM F2736 and F2764.

**Vertical Installations**

- Corrugated plastic pipe is sometimes installed vertically for use as catch basins or manholes, meter pits, and similar applications.
- Backfill should extend a minimum of 12" (0.3 m) completely around the vertical structure.
- Backfill material recommendations are described in standard details 405 and 406 as per application.
- Height of the vertical structure must not exceed 8' (2.4 m), unless the Application Engineering Department reviews the design.
- If traffic will be driving over a vertical structure, a concrete collar similar to that shown in Figure 6 shall be used to transfer the load into the ground.
- Cast iron frames holding grates or lids must be seated on a concrete collar or similar structure so that the weight of the frame and grate or lid is transferred into the ground, *not* to the vertical pipe.
- There may also be other product performance limits depending on the application. Contact Application Engineering for further information.

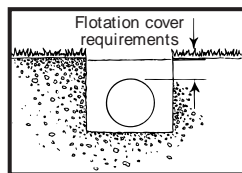


**Figure 6: Vertical Riser**



**Flotation**

- Table 7 shows minimum cover heights for various plastic pipe sizes to prevent flotation.



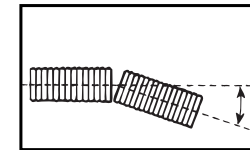
**Table 7:**

Required Minimum Cover* to Prevent Flotation		
	Nominal Diameter in. (mm)	Minimum Cover in. (mm)
SaniTite HP	12 (300)	9 (368)
	15 (375)	11 (457)
	18 (450)	13 (559)
	24 (600)	17 (711)
	30 (750)	22 (914)
	36 (900)	25 (1067)
	42 (1050)	29 (1219)
	48 (1200)	33 (1372)
	60 (1500)	40 (1702)

\*Based on the pipe being completely empty, water table at the ground surface, soil density of 130 pcf (2083 kg/m<sup>3</sup>), and a soil friction angle appropriate for most sand/gravel mixtures. The average of the inside and outside diameters was used to determine soil and water displacement.

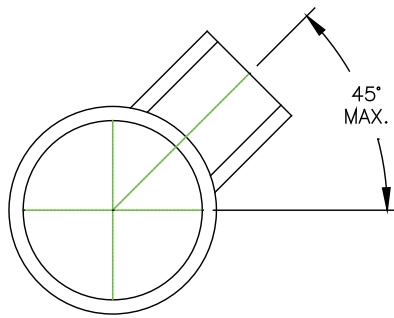
**Bending Radius**

A curved pipe alignment is sometimes desired in pipe systems so that they can be installed around buildings or utilities without the use of fittings. Plastic pipe can be angled slightly at the joints to create this curvature. Each bell-and-spigot joint can accommodate 3 degrees and remain at its specified joint quality. Additional information can be obtained through your Sales Representative or the Application Engineering Department.



## Service Connections

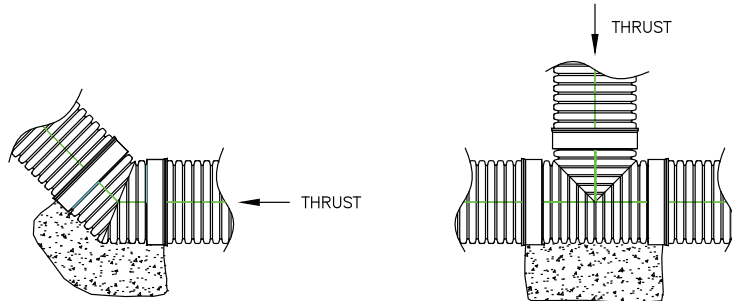
When using field connections, including an Inserta-Tee®, QwikSeal™, etc., the connecting stub should not be at an angle greater than 45° from horizontal. Angles exceeding 45° from horizontal may require flowable fill or concrete backfill to prevent “punch through” of the stub.



## Thrust Restraint

Cast-in-place concrete thrust blocks are the most common method of restraining the pipe and joints from thrust forces. Concrete should only be poured around the pipe and not around the joint to maintain joint flexibility. The size of the thrust block will be specified on the project plans.

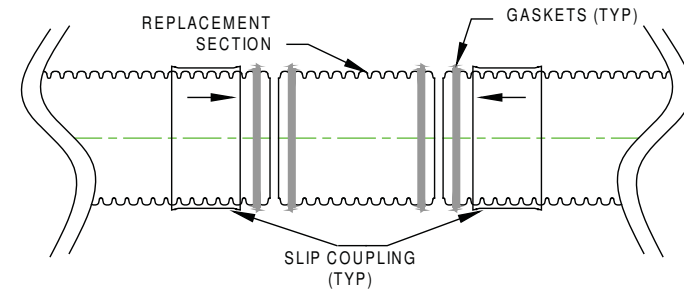
When using precast concrete blocks, a separating layer of backfill should be placed between the precast block and the fitting.



## Watertight Repair Methods

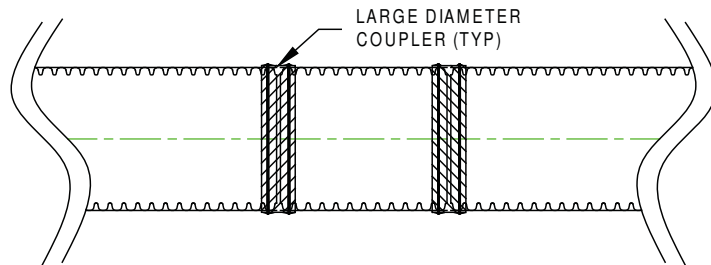
### Option 1: PVC Slip Coupling

For repairs of 12" - 24" (300-600 mm) pipe, a PVC slip coupling is recommended. The PVC slip coupling is typically used when a damaged section of pipe is cut and removed in an existing line. Couplings provide a bell-bell connection to join the existing pipe to a replacement section of pipe or other end of the existing pipe. Installation of PVC slip coupling should follow recommendations listed on page 20.



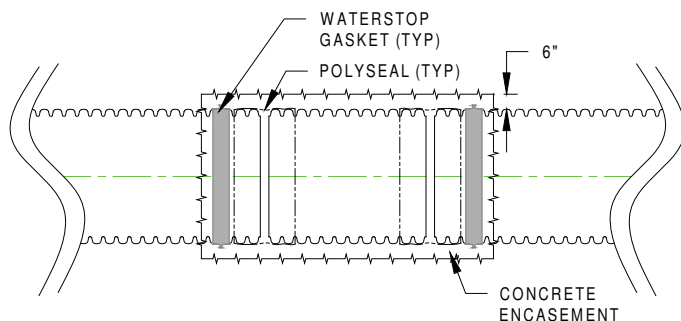
## Option 2: External Coupling

For 30" – 60" (750-1500 mm) pipe, large repair couplers, similar to those provided by Mission Rubber Company LLC, Fernco® Inc., or equal, may be used on HP triple wall pipe. Couplers are typically used when a damaged section of pipe is cut and removed in an existing line. Couplers are placed over the joint and tightened to the manufacturer's recommendation.



## Option 3: Concrete Collar

For 12" - 60" (300-1500 mm) pipe, a concrete collar can provide a water tight repair testable to most hydrostatic test with an appropriate leakage requirement. Installing a concrete collar involves building a form around the area to be repaired and encasing it in concrete. A *Mar Mac® Polyseal Pipe*



*Coupler* is wrapped around the repair area or joint prior to pouring the collar to keep the concrete from seeping into the pipe. *WaterStop* gaskets are installed outside of the *Polyseal* coupler towards the outside edge of the concrete collar. Typically, approximately 6" (0.15 m) is excavated beneath the pipe to allow for proper application of the *Polyseal* coupler and a concrete encasement. If the pipe itself is damaged, the damaged area shall be removed and a replacement pipe section spliced in prior to pouring the collar.

## Option 4: Chemical Grouting

For repairs of 12" - 60" (300-1500 mm) pipe with improperly assembled joints, chemical grouting can be considered an optional repair method. Chemical grout creates a waterproof collar around leaking pipes and joints.

## Option 5: Internal Sealing

For repairs of 18" - 60" (450-1500 mm) pipe with a damaged area on the interior, a repair with internal sealing methods may be used. Internal mechanical sealing is usually comprised of a metal band with a rubber gasket, which expands to conform to the inner wall of the pipe. The feasibility of this repair method depends on the size of the damaged section or joint and available access into the pipe.

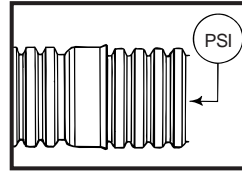
## Recommendations for In-Field Testing

Normally, a visual inspection is all that is necessary to identify proper line and excessive deflection. For additional in-field testing, the following criteria or methods should be used:



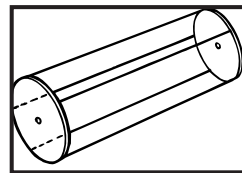
## Leakage Testing (where applicable):

After sanitary pipe has been installed, sections of pipe may be tested for leakage. When required, pipe shall be tested by water infiltration or by air pressure. The test method must be in accordance with ASTM F2487 for water and F1417 or C1103 for air. For additional information on field testing see Technical Note 5.17: *Post-Installation Testing of HP Pipe*.



## Deflection Testing:

If considered necessary, pipe deflection can be tested within 30 days of installation by pulling a mandrel through the installed pipe. Testing 10% of the overall project should provide a reasonable indication of installation quality. Table 8 lists the inside diameters that result from common testing limits of 5% and 7.5% deflection. Mandrel tests yield only pass/fail results and can provide misleading results. Before excavating, investigate to make sure the problem is not being caused by foreign material in the pipe, a slightly offset joint, or some other similar situation.



**Table 8:**

HP Recommended Mandrel Settings				
Pipe Type	Pipe Diameter	Minimum Inside Diameter	Inside Diameter with 5% Deflection	Inside Diameter with 7.5% Deflection
Dual Wall	12	11.90	11.31	11.01
	15	14.85	14.11	13.74
	18	17.93	17.03	16.59
	24	23.90	22.71	22.11
	30	29.79	28.30	27.56
Triple Wall	30	29.62	28.14	27.40
	36	35.40	33.63	32.75
	42	41.31	39.24	38.21
	48	47.31	44.94	43.76
	60	59.30	56.34	54.85

\*These measurements include allowable manufacturing tolerances.

All sales of our product are subject to a limited warranty and purchasers are solely responsible for installation and use of our products and determining whether a product is suited for any specific needs. Please consult a full copy of the Terms and Conditions of Sale for further details.

## Appendix

All product specific resources are available from the manufacturer's web site: see back cover

- DrainageHandbook
- Technical Note 2.05: Minimum and Maximum Burial Depths for SaniTite HP
- Technical Note 4.02: Chemical Resistance of Polypropylene and Elastomers
- Technical Note 4.03: Abrasion Resistance of Polypropylene
- Technical Note 5.01: Recommended Use for Trench Boxes
- Technical Note 5.02: Flowable Fill Backfill for Thermoplastic Pipe
- Technical Note 5.05: Pipe Flotation
- Technical Note 5.13: SaniTite HP Pipe Repair Options
- Technical Note 5.14: Culvert Sliplining with Polypropylene Pipe
- Technical Note 5.15: Integral Bell Transitions for HP Pipe
- Technical Note 5.16: Sealing Methods for Vent Tubes
- Technical Note 5.17: Post-Installation Testing of SaniTite HP
- STD-100 series, Trench Installation Details for SaniTite HP Pipe
- STD-200 series, Manhole Connection Details for SaniTite HP Pipe
- STD-400 series, Riser Installation
- STD-600 series, Adapting to Dissimilar Materials

ADS "Terms and Conditions of Sale" are available on the ADS website,  
[www.ads-pipe.com](http://www.ads-pipe.com)

Advanced Drainage Systems, SaniTite® and the Green Stripe are registered  
trademarks of Advanced Drainage Systems, Inc.

Mar-Mac® is a registered trademark of Mar-Mac® Construction Products, Inc.

Fernco® and QwikSeal™ are a registered trademarks of Fernco, Inc.

Inserta-Tee® is a registered trademark of Inserta-Tee

Chevy® is a registered trademark of General Motors Corporation.

Bobcat® is a registered trademark of Bobcat Company.

A-LOK® is a registered trademark of A-LOK Products, Inc.

Kor-N-Seal® is a registered trademark of NPC, Inc.

© 2010 Advanced Drainage Systems, Inc.

INS10667 05/10 MH

Advanced Drainage Systems, Inc.  
4640 Trueman Blvd. Hilliard, OH 43026  
800-821-6710

[www.ads-pipe.com](http://www.ads-pipe.com)

*The Most **Advanced** Name in Drainage Systems®*

