

# Hydrodrain<sup>®</sup> StripDrain



A SIKA COMPANY

## GENERAL DESCRIPTION

Hydrodrain StripDrain is a modular composite drainage and collection system consisting of a 3-dimensional, high-flow, drainage core, available in 6 and 12 inch widths, which is wrapped with a non-woven filter fabric. Soil particles are held back by the filter fabric allowing water to pass through to the drain core for easy removal to subsurface collection. StripDrain is combined with a full array of fittings to allow for a fast and easy installation. Hydrodrain SD-Tape is used to attach all Hydrodrain StripDrain fittings – End Caps, End Outlets, Side Outlets, Corners, Splices, and Step Downs. Hydrodrain StripDrain sections and fittings can be bonded to the waterproofed wall with an appropriate means or held in place with soil backfill.



## BASIC USE

Hydrodrain StripDrain is designed to replace a conventional sand or gravel covered pipe drain around building foundations and retaining walls. Hydrodrain StripDrain is installed along the base of a foundation wall and may be combined with Hydrodrain 400 or 420 for a complete foundation wall drainage assembly. Hydrodrain must be covered with subsequent overburden within 10-14 days of installation.

## ADVANTAGES

- Eliminates pipe & gravel
- Lightweight and easy to install
- Saves time and labor – cost effective

## SIZES

The Hydrodrain StripDrain is available in roll form, 6 or 12 inches wide/tall by 165 feet long, weighing 38 or 68 pounds respectively.

## TECHNICAL DATA

PROPERTY	TEST METHOD	GEOTEXTILE	RESULTS
THICKNESS	ASTM D1777	--	1.0 in.
COMPRESSIVE STRENGTH	ASTM D1621	--	9,500 psf
FLOW Hydraulic Gradient = 0.1	ASTM D4716	--	30 gal. / min. / ft. width
FLOW	ASTM D4491	140 gal. / min. / ft. width	--
CBR PUNCTURE	ASTM D6241	250 lb.	--
GRAB TENSILE	ASTM D4632	100 lb.	--
APPARENT OPENING SIZE	ASTM D4751	70 U.S. Sieve	--

**FOUNDATION WALL**

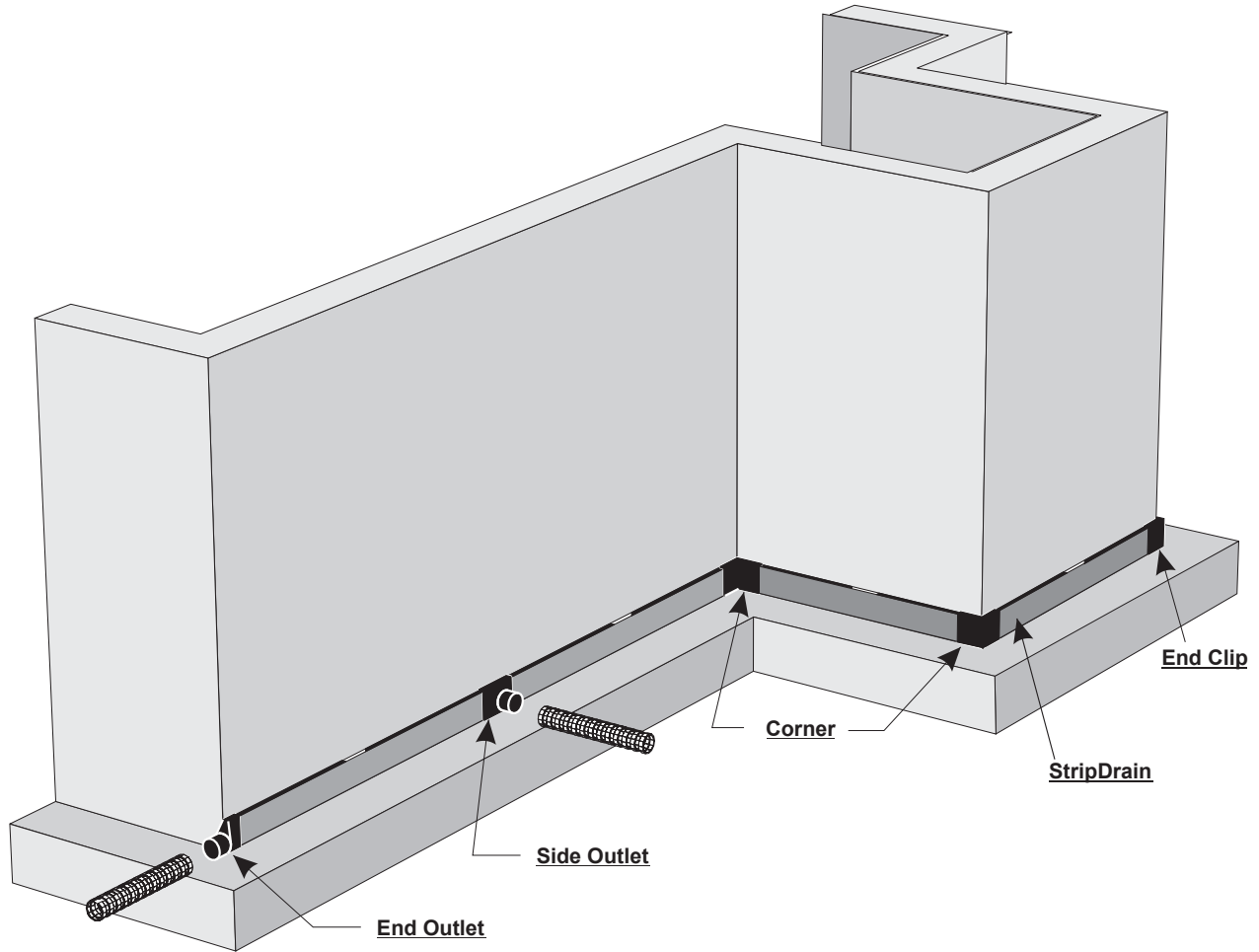

**ACCESSORIES**

**END OUTLET**

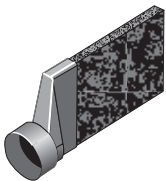

**END CAP**

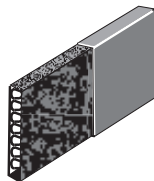

**SIDE OUTLET**

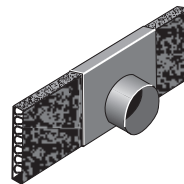

**SPLICE**

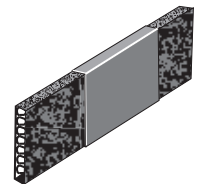

**CORNER**

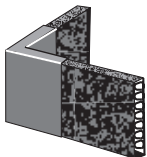

**STEP DOWN**

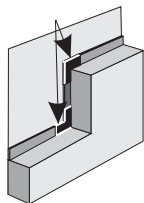

**SD-TAPE**



This information is intended only for general conceptual purposes. It is based on data and knowledge considered to be true and correct. It is offered for the user's consideration, investigation and verification and is not intended to substitute for the advice provided by appropriate professionals. Hydrotech assumes no liability for the use of this information. The determination of the suitability and applicability of this information is the sole responsibility of the user.