

Drywall Accessories

Spring 2002

Vinyl Drywall Accessories

Table of Contents

Corner Bead	2 - 5
Corner Bead	2
Arch Corner Bead	3
120° Corner Bead - Wide Angle	3
Bull Nose Corner Bead	4
Bull Nose Corner Caps	4
Bull Nose Arch Corner Bead	5
120° Bull Nose Corner Bead - Wide Angle	5
Bull Nose Inside Corner Bead	5
Casing Bead	6
Bull Nose Casing "J" Bead	6
Drywall Bead	7 - 9
"J" Bead	7
Shadow Line "J" Bead	7
"MJ" Bead	8
"L" Bead	8
Zip Strip Bead	9
Control Joint	10
"F" Channel Reveal	11
Soffit Accessories	12
Soffit Vent Inserts	12
Soffit Vent	12
Specifications	13



Drywall Corner Bead

Vinyl Drywall Accessories

Spring 2002

AMICO Drywall Corner Bead is a strong, durable and straight reinforcement for drywall and veneer plaster corners. All surfaces that receive finish have ridges for better finish adhesion. The nose of this bead acts as a ground and screed to help the applicator achieve the proper depth of finish.

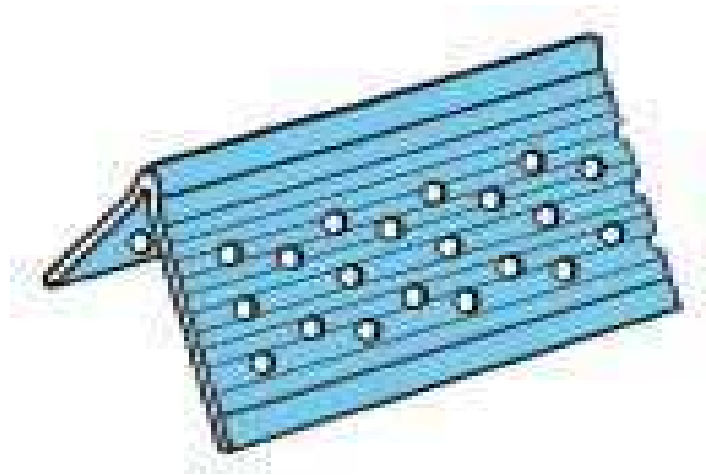

Drywall Corner Bead

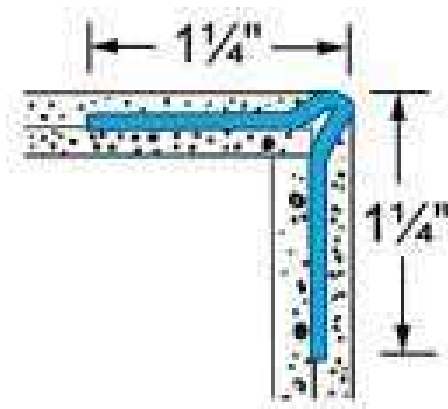

PRODUCT NO.	DIMENSIONS	LENGTH	BOARD THICKNESS	PCS PER BOX
DRYWALL CORNER BEAD AMCB125	1 1/4" x 1 1/4" Perforated Flange	8' & 10'	ALL	100

Drywall Corner Bead

Spring 2002

Vinyl Drywall Accessories



Drywall Arch Corner Bead

AMICO Drywall Arch Corner Bead the drywall arch corner bead is pre-notched to facilitate the curving of this bead during installation. Perforations and ridges on all surfaces that receive finishing compound or veneer assure excellent adhesion. AMICO'S improved notches form more uniform curves than some products currently available.

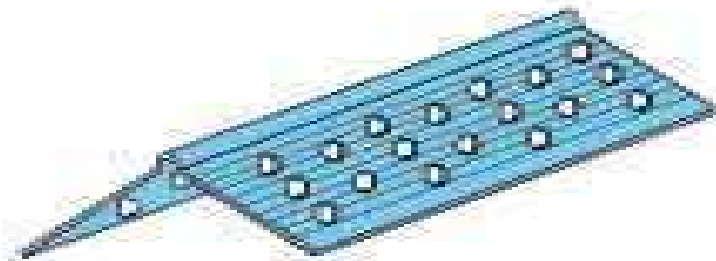

120° Wide Angle Drywall Corner Bead

AMICO 120° Drywall Corner Bead (Wide Angle) has the same characteristics as regular drywall corner bead except that the angle has been opened wider to allow for larger or irregular corners.

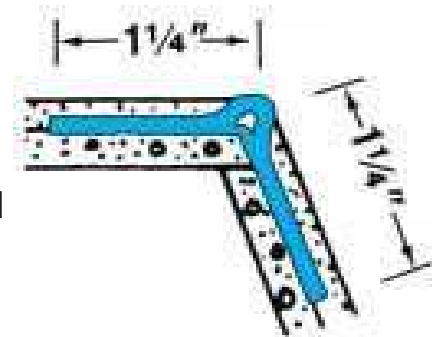

Special Lengths Are Available on Request

PRODUCT NO.	DIMENSIONS	LENGTH	BOARD THICKNESS	PCS PER BOX
DRYWALL ARCH CORNER BEAD AMCB125A	1 1/4" x 1 1/4" Perforated Flange One Flange Slotted	8' & 10'	ALL	50
DRYWALL 120° CORNER BEAD AMCB125WA	1 1/4" x 1 1/4" Perforated Flange	8' & 10'	ALL	50

Bull Nose Corner Bead

AMICO Bull Nose Drywall Corner Bead provides an architecturally attractive corner that is both durable and straight for a softer more rounded appearance.

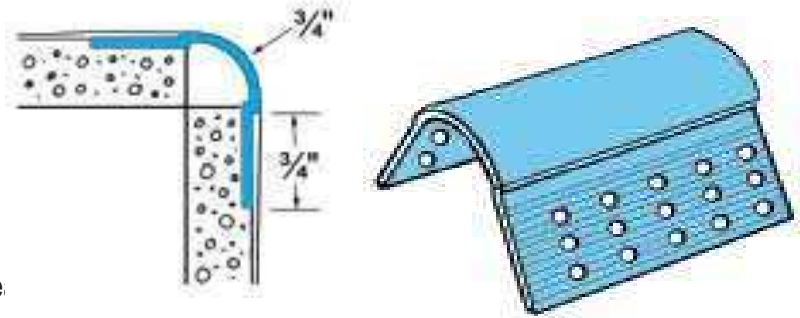

Drywall Bull Nose Corner Be

AMICO Bull Nose Drywall Corner Caps add the perfect finishing touch to compliment the bull nose corner bead system. These caps are great time savers that allow the installer to avoid the costly procedure of mitering corners.

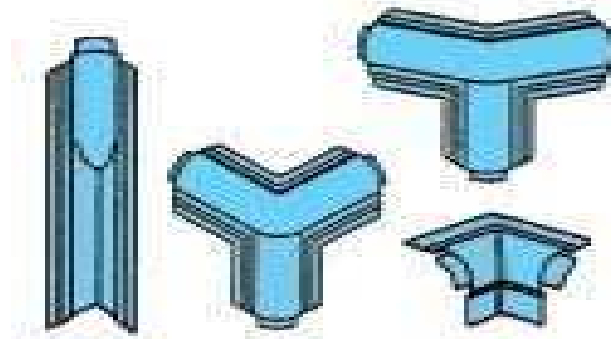

Drywall Bull Nose Corner Caps

PRODUCT NO.	DIMENSIONS	LENGTH	BOARD THICKNESS	PCS PER BOX
DRYWALL BULL NOSE CORNER BEAD AMBNCB-75	3/4" x 3/4" Perforated Flange	8' & 10'	ALL	50
DRYWALL CORNER CAPS AMCC100	1-WAY	N/A	N/A	50
DRYWALL CORNER CAPS AMCC200	2-WAY 90°	N/A	N/A	50
DRYWALL CORNER CAPS AMCC333	3-WAY Off Angle	N/A	N/A	50
DRYWALL CORNER CAPS AMCC750	3-WAY 90°	N/A	N/A	50
DRYWALL BASE TRANSITION AMBTC8590	Cap / Base Transition	N/A	N/A	50

Bull Nose Corner Bead

Spring 2002

Vinyl Drywall Accessories

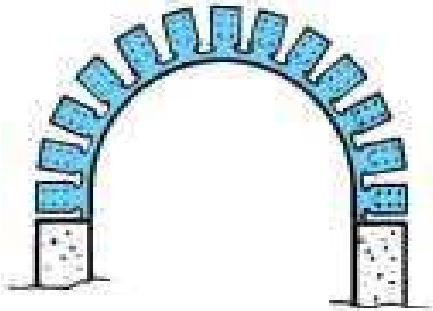

Arch Bull Nose
Corner Bead

AMICO Bull Nose Arch Corner Bead provides strength and durability to curved edges that require a softer more rounded appearance to the corner. The bull nose arch corner bead is pre-notched to easily facilitate the curving of this bead during installation.

120° Bull Nose
Corner Bead

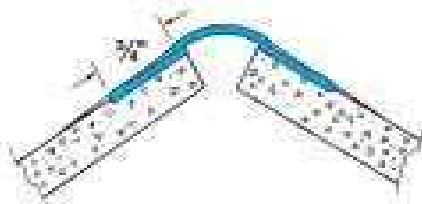

AMICO 120° Bull Nose Corner Bead has the same properties as regular bull nose corner bead except that it offers a wider angle to accommodate larger or irregular corner sizes.

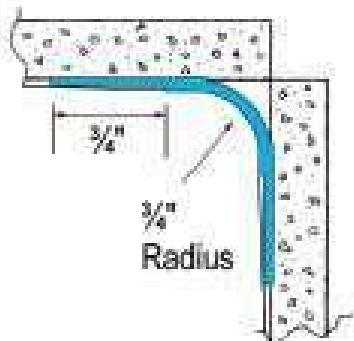

Drywall Bull Nose
Inside Corner Bead

AMICO Bull Nose Inside Corner Bead is used to form smooth and straight bull nose inside corners. This bead once again offers the softer more rounded appearance to the inside corner that will correspond with the rest of the bull nose bead system.

PRODUCT NO.	DIMENSIONS	LENGTH	BOARD THICKNESS	PCS PER BOX
BULL NOSE ARCH CORNER BEAD AMBNCB-- ARCH	3/4" x 3/4" Perforated Flange One Flange Slotted	8' & 10'	ALL	50
120° BULL NOSE CORNER BEAD AMBNWA	3/4" x 3/4" Perforated Flange	8' & 10'	ALL	50
INSIDE CORNER BULL NOSE CORNER BEAD AMBNIC	3/4" x 3/4" Perforated Flange	8' & 10'	ALL	50

Bull Nose Casing "J" Bead

Vinyl Drywall Accessories

Spring 2002

AMICO Bull Nose Casing "J" Bead (Half Round) is the perfect casing to complement installations that incorporate bull nose drywall beads. This bead will fit either 1/2 inch or 5/8 inch gypsum board as an end finish. When used as edging for a dry wall bands, this bead fits only 5/8 inch board. This bead is used to terminate gypsum board at doors, cased openings, and to create decorative bands.

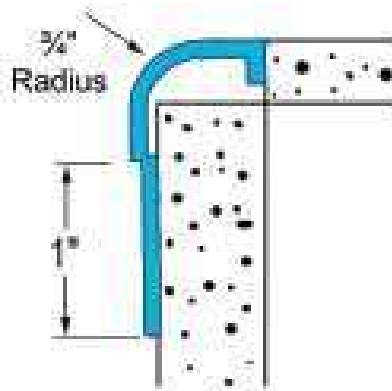

Bull Nose Casing "J" Bead

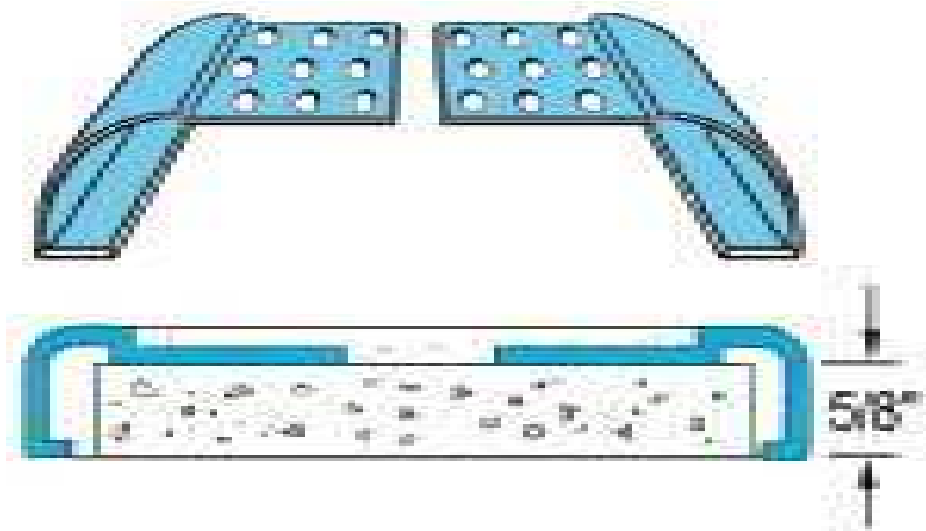

PRODUCT NO.	DIMENSIONS	LENGTH	BOARD THICKNESS	PCS PER BOX
DRYWALL "J" BEAD BULL NOSE CASING AMBNC-100	1 3/4" Overall Width 1" Perforated Flange	10'	All	50

Vinyl Drywall Bead

Spring 2002

Vinyl Drywall Accessories

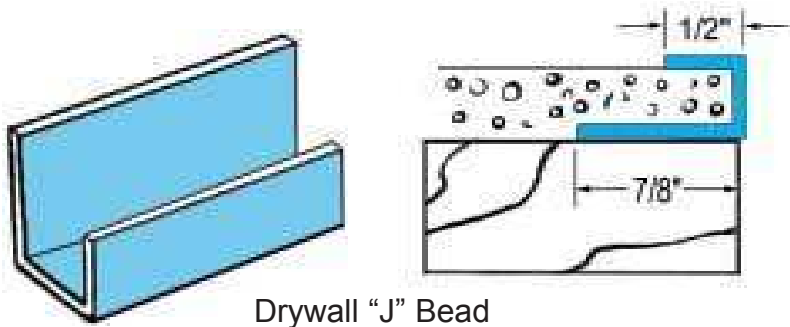

Drywall "J" Bead

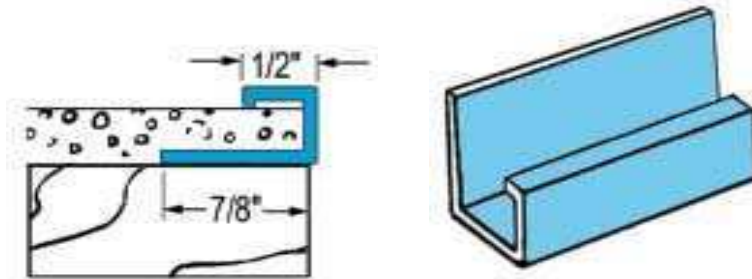

Drywall Shadow Line "J" Bead

AMICO Drywall "J" Bead is used to give a finished appearance to the edge of gypsum board. It has excellent adhesion properties for any type of interior paint. It is often used to isolate gypsum board from dissimilar materials such as aluminum windows. Galvanized beads often react to dissimilar metals such as aluminum causing premature corrosion.

AMICO Shadow Line "J" Bead creates a shadow along the finished edge of the gypsum board to provide a decorative effect.

Note: Special Lengths Are Available Upon Request.

Vinyl Drywall Bead

AMICO Drywall "MJ" Bead (Perforated)

covers and protects the edges of gypsum wallboard. Perforations and ridges are placed on all surfaces that receive veneer or finishing compound assure excellent adhesion.

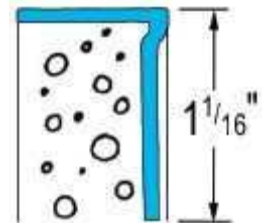
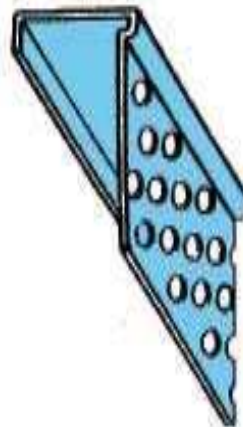

Drywall "MJ" Bead

AMICO Drywall "L" Bead (Perforated)

is used to protect the edges of gypsum wallboard. Perforations and ridges placed on all surfaces that receive finishing compound or veneer assure excellent adhesion.

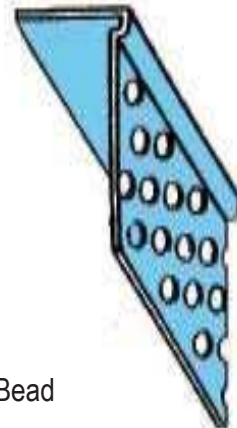
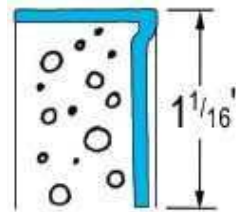

/Drywall "L" Bead

Note: Special Lengths Are Available Upon Request.

Standard Length 10 Feet

PRODUCT NO.	DIMENSIONS	BOARD THICKNESS	PCS PER BOX
DRYWALL "MJ" BEAD Perforated Flange AMMJB50	1-1/16" Width 1/4" Return	1/2"	50
DRYWALL "MJ" BEAD Perforated Flange AMMJB58	1-1/16" Width 1/4" Return	5/8"	50
"L" STOP BEAD Perforated Flange AMSB50	1-1/8" Width	1/2"	50
"L" STOP BEAD Perforated Flange AMSB58	1-1/8" Width	5/8"	50

Drywall Zip Strip Bead

Spring 2002

Vinyl Drywall Accessories

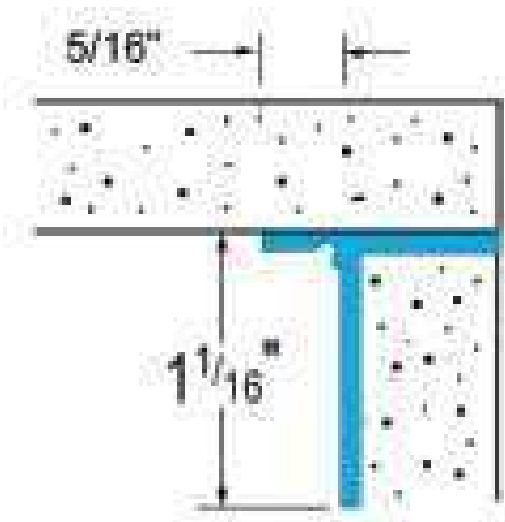

AMICO "ZIP STRIP" Ceiling "L" Trim has a removable masking strip that allows this bead to be finished without staining the adjacent ceiling. Perforations and ridges placed on all surfaces that receive finishing compound or veneer plaster assures excellent adhesion.

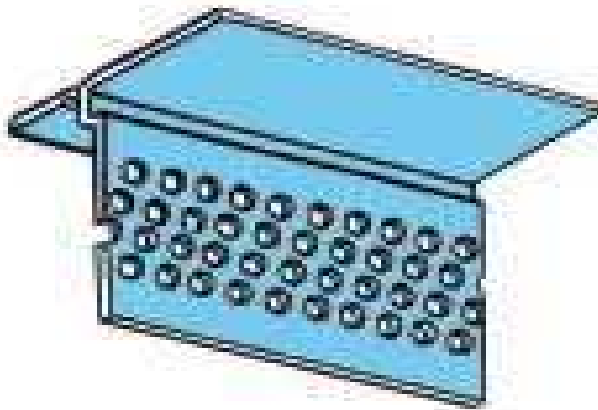

Standard Length 10 Feet

PRODUCT NO.	DIMENSIONS	BOARD THICKNESS	PCS PER BOX
"ZIP STRIP" CEILING "L" TRIM AMZIP-50	1-1/16" Width Perforated Flange 5/16" Removable Leg	1/2"	50
"ZIP STRIP" CEILING "L" TRIM AMZIP-58	1-1/16" Width Perforated Flange 5/16" Removable Leg	5/8"	50

Drywall Control Joint

Vinyl Drywall Accessories

Spring 2002

AMICO

Drywall Control Joint Deep "V"
(with Removable Tape)

is designed to help relieve stress in large areas of drywall or veneer plaster installations. Perforations and ridges on all surfaces that receive finishing compound or veneer assure excellent adhesion. Provides a 1/16" ground.

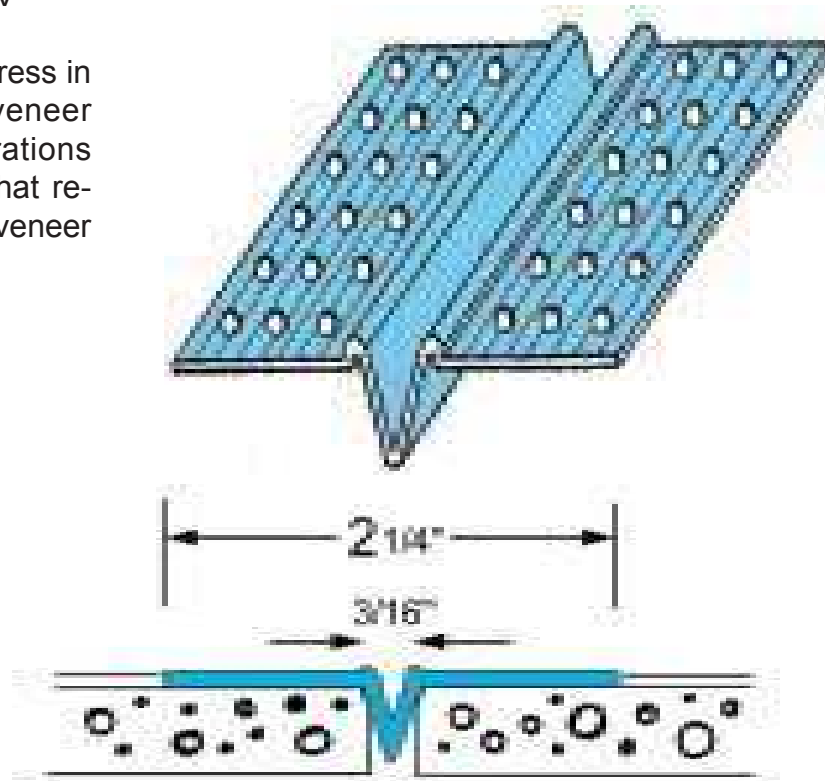

Drywall Vinyl Control Joint

Standard Length 10 Feet

PRODUCT NO.	DIMENSIONS	LENGTH	BOARD THICKNESS	PCS PER BOX
CONTROL JOINT With Removeable Tape AMDCJV16	2 1/4" Width Perforated Flange 3/16" Reveal	10'	ALL	60

Drywall Reveals

Spring 2002

Vinyl Drywall Accessories

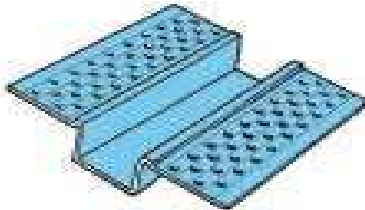
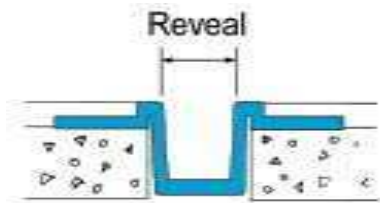

Drywall Vinyl Reveal

AMICO Drywall Reveal are used to provide an architectural or decorative relief in gypsum panels. Reveals are easily installed to provide a straight reveal in either 1/2" or 5/8" gypsum board.

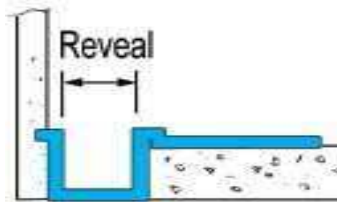
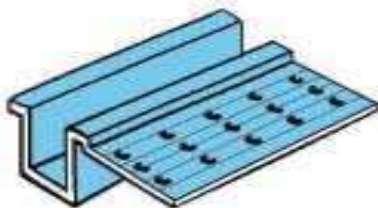

Drywall Vinyl "F" Channel Reveal

AMICO "F" Channel Reveal are designed to provide an architectural relief in drywall surfaces at wall and ceiling terminations, or at junctures with dissimilar material.

Standard Length 10 Feet

PRODUCT NO.	REVEAL DIMENSIONS	LENGTH	BOARD THICKNESS	PCS PER BOX
DRYWALL REVEAL AMDWR-50	1/2"	8' & 10'	ALL	35
DRYWALL REVEAL AMDWR-75	3/4"	8' & 10'	ALL	35
DRYWALL REVEAL AMDWR-100	1"	8' & 10'	ALL	35
DRYWALL "F" CHANNEL REVEAL AMDFR-50	1/2"	10'	ALL	35
DRYWALL "F" CHANNEL REVEAL AMDFR-75	3/4"	10'	ALL	35
DRYWALL "F" CHANNEL REVEAL AMDFR-100	1"	10'	ALL	35

Soffit Vent Inserts

AMICO Soffit Vent Inserts

2", 3" & 4" Soffit Vent Inserts provide continuous attic ventilation through the perforated surface. Shoulders are a full 3/8 inch deep to protect sheathing edges and to provide a caulking surface. This product is often installed directly to the bottom of the joist, prior to the installation of the sheathing. This provides a continuous airflow along the entire length of the soffit.

AMICO Soffit Vent

for Sheathing provides continuous attic ventilation like our soffit insert, while offering better protection to the edges of sheathing, this may eliminate the need for caulking in some cases.

Standard Length 10 Feet

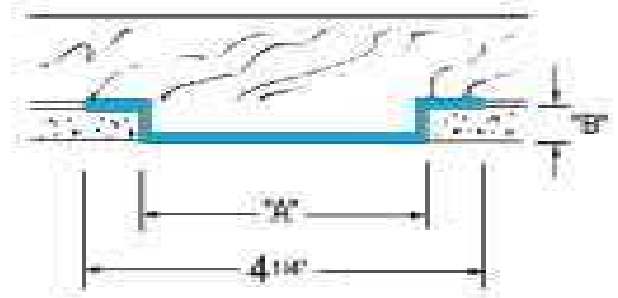

Drywall Soffit Vent Inserts

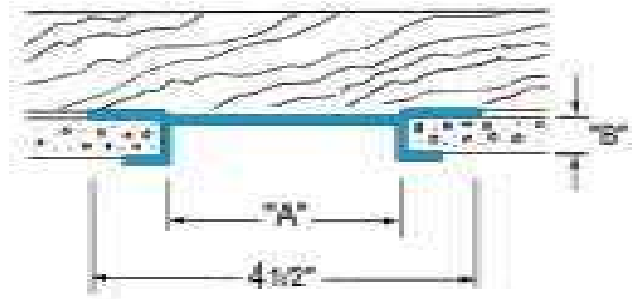

Drywall Soffit Vent

Vinyl Drywall Accessories Specifications

Spring 2002

Vinyl Drywall Accessories

PRODUCT DATA AND SPECIFICATION Drywall Accessories

1. PRODUCT NAME

AMICO Rigid Vinyl (PVC) Beads

2. MANUFACTURER

AMICO

Alabama Metal Industries Corporation

P.O. Box 3928

Birmingham, AL 35208

Telephone: 800-366-2642

Facsimile: 205-780-7838

3. DESCRIPTION AND PERFORMANCE

Drywall accessories are manufactured from the highest quality exterior grade vinyl compounds, which are specially formulated for exterior applications. These beads are designed to function at optimum levels in most climatic conditions for many years of service.

Long Lasting:

AMICO bead products will not rust, peel, or affect the plaster mix in any way. Accessories will hold their shape, and stay true and straight when installed properly.

Thru-Color:

The color is solid throughout the product. They are not coated, there is nothing to peel or chip.

Paint Adhesion:

Excellent with no preparation required.

Flammability:

PVC products will not support or spread flames, They are self extinguishing as soon as the flame source is removed, therefore, it will not start a fire. All AMICO vinyl bead products meet code requirements for smoke and flame spread as stated in ASTM-E84. Rigid vinyl will not conduct electricity and offers a very low thermal conductivity.

Adhesion of Drywall Accessories:

All AMICO Vinyl Drywall Beads are provided with adequate perforations to allow complete embedment. Many drywall products have serrations on the flange. This aids in the adhesion of the finish to the drywall accessory. This allows all drywall accessories to key to the attached gypsum board for complete bonding of the system. Perforations allow the finishing compound to penetrate the bead and allow the complete bonding of the joint compound.

4. TECHNICAL DATA

Specific technical data may be obtained by calling AMICO technical support at 800/366-2642 ext. 205.

All AMICO Drywall Accessories conform to:

ASTM C-844

ASTM C-1047

ASTM D-1784