

Armor-Tile

Tactile Systems

We appreciate your interest in our **Armor-Tile Detectable Warning Surface Tile Systems**, and as requested we are enclosing our recently updated submittal package.

This informative compilation includes a copy of our brochure, product specifications, installation manuals, blueprints, laboratory test results, cleaning and maintenance instructions, a sample warranty form, a letter of compliance, and our standard colors. This information should prove useful in determining the **Armor-Tile System** (Cast In Place or Surface Applied) best suited to your project requirements. However, if additional information is required, such as project specific blueprints and specifications, we would be pleased to produce a detailed proposal specific to your project requirements.

The principal features that have established **Armor-Tile** as the industry leader in tactile systems are:

- “Diamond hard” vitrified polymer composite, with high wear resistance derived from the aluminum oxide composition (wear index <0.06 ASTM D 2486, >500 ASTM C 501)
- Extremely slip resistant, wet or dry (>0.8 ASTM C 1028)
- High density, non-porous material for freeze/thaw resistance and ease of maintenance (water absorption <0.05% ASTM D 570)
- High impact resistance and compressive strengths as compared to concrete, porcelain or granite (impact >550 in.-lb f/in ASTM D 5420, compressive > 28,000 psi ASTM D 695)
- Chemical and stain resistant surface (ASTM D 543)
- UV stable weather resistant composite with color throughout the tile matrix (3000 hrs. ASTM G 155-05a)
- Enhanced design of detectable warning surface to provide a safer, more accessible walking surface for all disability groups, including mobility impaired, the elderly and women in high heels.
- Three tile systems engineered to accommodate various installation conditions, including Cast In Place, Surface Applied, and Modular Paver Tiles.

We trust this overview of the **Armor-Tile Systems**, together with the information contained in our submittal package is helpful in determining the **Armor-Tile System** best suited to your project requirements. Please feel free to contact our technical support department (tech@engplastics.com) or our sales department (sales@engplastics.com) for any additional information you may require, or for a quotation on your project. If you would like to speak directly with our sales or engineering representatives please call us directly by dialing toll free **1-800-682-2525**.

Yours very truly,

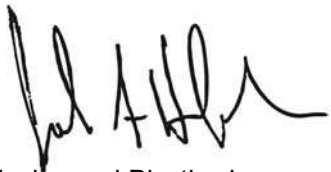

Engineered Plastics Inc.
John Heffner
johnh@engplastics.com
Vice President

ENGINEERED PLASTICS INC.

300 International Dr., Suite 100, Williamsville, NY 14221 Tel: 1-800-682-2525 Fax: 1-800-769-4463

www.armor-tile.com



Armor-Tile

Tactile Systems

Product Presentation

Armor-Tile is the market leader in detectable warning and way finding solutions for the visually impaired with a variety of installation systems for use in any construction application. Armor-Tile Detectable Warning Surface Systems are fully compliant with the Americans with Disabilities Act (ADA) and California Building Code Title 24.

Applications

Armor-Tile has application systems that can be used anywhere the safety of the visually impaired is a concern such as, curb ramps, depressed curb walkway systems, shopping malls, transit platforms, parking areas, stairwells, and escalator approaches.

Features

Armor-Tile is available in various sizes and colors to suit your project specific requirements. Cast-In-Place Tiles can be installed during the casting of new concrete, Surface Applied Tiles can be used to retrofit existing concrete surfaces and Modular Pavers can be installed on compacted granular fill or wet set into a mortar bed. Directional Tiles can be installed in areas where the visually impaired need to be directed to shelters, doorways or general walkway approaches and Guidance Tiles are used as a tactile pathway across a vehicular way.

Benefits

Armor-Tile is consistently ranked number one in government reports as the most durable and detectable warning surface available.

- Armor-Tile is in full compliance with Americans with Disabilities Act (ADA), California Building Code (Title 24).
- Department of Transportation approved and the specified product of choice by cities and counties from Alaska to Florida.
- Vitrified Polymer Composite employing aluminum oxide for outstanding abrasion resistance as well as excellent resistance to chemicals and salt, freeze thaw resistance and high Gardener Impact resistance even in cold weather.
- Leading technology in ultra violet protection.
- Cast-In-Place, Surface Applied and Modular Paver available in sizes 12"x12", 24"x24", 24"x36", 24"x48", 24"x60, 36"x48", 36"x60"

Installations

Step-by-step installation procedures can be viewed in slide show format on our web site or by request in CD format. Written installation procedures for all applications are included in sales literature and can be downloaded from our web site. Please contact us directly for a distributor in your area.

For Additional Information

Visit the Armor-Tile Web Site at www.armor-tile.com

Contact

Engineered Plastics Inc.
300 International Drive, Suite 100
Williamsville, NY 14221

Tel: 800 682-2525 Fax: 800-769-4463

Website: <http://www.armor-tile.com> Email: sales@engplastics.com



ENGINEERED PLASTICS INC.

300 International Dr., Suite 100, Williamsville, NY 14221 Tel: 1-800-682-2525 Fax: 1-800-769-4463

www.armor-tile.com

r1015

Armor-Tile™

Tactile Systems

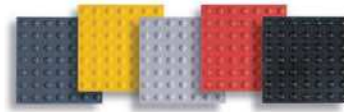

Armor-Tile™

Setting the standard for **durability and detectability** in tactile systems.

The world's largest selection of detectable warning products for:

- Curb Ramps
- Vehicular Areas
- Parking Areas
- Stairways
- Pedestrian Crossings
- Escalator Approaches
- Transit Platforms
- Multi-Modal Transit Stations

Installation

A. Cast in Place: Pour and float concrete, set tile by tamping down into concrete until all air voids are removed, edge around perimeter, cut off protective plastic sheet.

B. Surface Applied: Grind substrate, remove dust on tile and substrate, apply adhesive to back of tile, drill into concrete, install fasteners, clean tile surface, apply perimeter sealant.

C. Modular Paver: Box out or saw cut concrete, lay a gravel or mortar bed, tamp paver onto substrate, place 3/8" diameter foam rope at bottom of all joints, apply joint sealant.

D. Directional Tile: Grind substrate 3/16" deep, 6" wide, saw cut two 3/4" deep grooves, remove dust on tile and substrate, apply adhesive to back of tile, drill into concrete, install fasteners, clean tile surface, apply perimeter sealant.

E. Guidance Tile: Pour and float concrete, set tile by tamping into concrete until all air voids are removed, edge around the perimeter.

Easy to Install

Please see www.Armor-Tile.com for detailed installation instructions and videos.

Manufacturer training is available to establish the highest quality standards.

Who we are.....

Armor-Tile™ is the world leader in detectable warning systems. Manufactured of a diamond-hard vitrified polymer composite, Armor-Tile™ truncated dome and directional tiles are the industry leader for durability, weather and wear resistance.

Armor-Tile™ is your one stop source for all tactile systems for the visually impaired. Only Armor-Tile™ provides a complete range of products designed for the safety and convenience of the visually impaired, in full compliance with the Americans with Disabilities Act (ADA).

Please visit www.Armor-Tile.com for information on ADA regulations, detailed products specifications, detail drawings, installation instructions and videos, distributor information and more.....

ASTM and UL Testing

- Water Absorption - ASTM D570-98 - Less than 0.08%
- Slip Resistance - ASTM C1028-96 - Greater than 0.80
- Compressive Strength - ASTM D695-02a - Greater than 28,000 psi
- Tensile Strength - ASTM D638-02a - Greater than 28,000 psi
- Flexural Strength - ASTM D790-03 Greater than 25,000 psi
- Chemical Stain Resistance - ASTM D543-95 - No discoloration or staining
- Abrasive Wear - ASTM D2486-00 - Less than 0.060 after 6000 cycles
- Wear Resistance - ASTM C501-84 - Greater than 500
- Accelerated Weathering - ASTM G155-05a for 3000 hrs no fading or chalking
- Freeze/Thaw - ASTM D1037-99 no cracking, delamination, or other defects
- Salt Spray - ASTM B117-03 for 200 hours no deterioration

AVAILABLE IN THE FOLLOWING SIZES AND COLORS:

12"X12" • 24"X24" • 24"X36" • 24"X48" • 24"X60"
36"X48" • 36"X60"



Federal Yellow (YW)
FED 33538



Ochre Yellow (OCR)
FED 23594



Colonial Red
FED 20109



Brick Red (RD)
FED 22144



Onyx Black (BK)
FED 17038



Dark Gray (DG)
FED 36118



Light Gray (LG)
FED 26280



Pearl White
FED 37875



Ocean Blue
FED 15187

Armor-Tile.com

Replaceable Cast in Place - Herculite Series

The Herculite Series Cast in Place system features the ability to easily replace the tile surface without the removal and replacement of concrete. The tamper-proof stainless steel fastener maintains a flush tile surface and the corrosion resistant hexagonal anchor integrates with the concrete for optimal anchoring power.

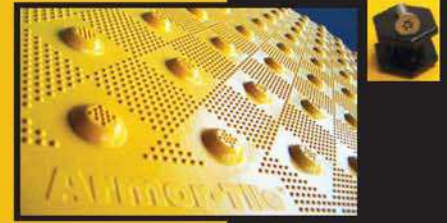

Cast in Place

The traditional cast in place detectable warning tile is an ideal solution for tactile needs and boasts the lowest installation cost available. The integral embedment flanges are the complete anchoring system and the tile is easily cut for angle or radius applications.

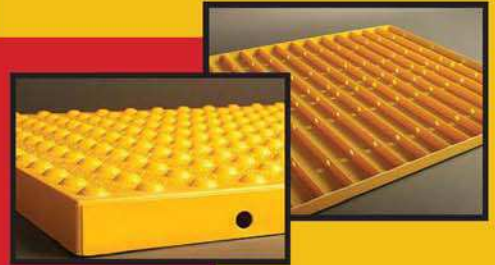

Surface Applied

A cost effective solution for retrofit applications or new construction the surface applied tile is supplied as a complete system including the Tile, Adhesive, Fasteners and Sealant. The beveled perimeter edge ensures a smooth transition from the substrate to the detectable warning surface and meets ADA requirements. In addition the surface applied tile is easily cut to conform to angle or radius ramps.

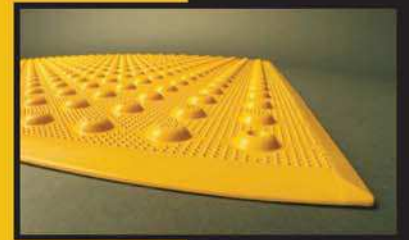

Modular Paver

The Armor-Tile™ Modular Paver is the solution of choice to integrate with landscape pavers, the high strength modular paver can be dry laid on compacted fill or set in a grout bed or drypac. It is also easily cut for angle or radius ramps and available in 12"x12" or 24"x 24".



Detectable Directional

Tactile Pathway

The typical areas of use for the detectable directional are university campuses, parks, sidewalks, and transit facilities. The detectable directional is a cost effective solution for both retrofit conditions or new construction and supplied as a complete system with the Tile, Adhesive, Fasteners, and Sealant and is available in the following sizes; 12"x12", 6"x48", 12"x48, 24"x48", 36"x48", 36"x60"



Detectable Guidance

Pedestrian Crossing Guide Strip

The Detectable Guidance Tile is to be used as a tactile pathway for the visual community at pedestrian crossings in roadways. The integral embedment flanges are the complete anchoring system for a new construction application and is available in 4"x24"



Armor-Tile™

Tactile Systems



Engineered Plastics Inc.

300 International Drive #100
Williamsville NY 14221

Tel: (800) 682-2525
Fax: (800) 769-4463

Armor-Tile.com

CAST IN PLACE DETECTABLE/TACTILE WARNING SURFACE TILE

PART 1 GENERAL

1.01 RELATED DOCUMENTS

- A. Drawings and general provisions of Contract, including General and Special Conditions and Division 1 Specifications Section, apply to this Section.

1.02 DESCRIPTION

- A. This Section specifies furnishing and installing Cast in Place Detectable/Tactile Warning Surface tiles where indicated.

1.03 SUBMITTALS

- A. Product Data: Submit manufacturer's literature describing products, installation procedures and routine maintenance.
- B. Samples for Verification Purposes: Submit one (1) 12" x 12" size tile sample.
- C. Shop drawings are required for products specified showing fabrication details, composite structural system, tile surface profile, fastener and anchor locations, plans of tile placement including joints, and material to be used as well as outlining installation materials and procedure.
- D. Material Test Reports: Submit complete test reports from qualified accredited independent testing laboratories to qualify that materials proposed for use are in compliance with requirements and meet or exceed the properties indicated on the specifications. All tests shall be conducted on a Cast in Place Warning tile (or approved equal) as certified by a qualified independent testing laboratory.
- E. Maintenance Instructions: Submit copies of manufacturer's specified installation and maintenance practices for each type of Warning tile and accessory as required.

1.04 QUALITY ASSURANCE

- A. Provide Cast in Place Warning tiles and accessories as produced by a single manufacturer with a minimum of three (3) years' experience in the manufacturing of Cast in Place Warning tiles.
- B. Installer's Qualifications: Engage an experienced installer certified in writing by Cast in Place Warning tile manufacturer as qualified for installation, who has successfully completed installations similar in material, design, and extent to that indicated for the project.
- C. Provide Cast in Place Warning tiles which are in compliance with the following standards (or most recent):
 - a. Americans with Disabilities Act (Title III Regulations, 28 CFR Part 36 ADA STANDARDS FOR ACCESSIBLE DESIGN, Appendix A, Section 4.29.2 DETECTABLE WARNINGS ON WALKING SURFACES).
 - b. California Code of Regulations (CCR): Provide only approved DSAAC detectable warning products as provided in the California Code of Regulations (CCR) Title 24, Chapter 2,

Section 202 definition of "Detectable Warning". Section 11B-247 and 11B-705
 "Detectable Warnings And Detectable Directional Texture"

- D. Vitrified Polymer Composite (VPC) Cast in Place Warning tiles shall be an epoxy polymer composition with a ultra-violet coating employing aluminum oxide particles in the truncated domes; "Armor Tile" as distributed under license by Engineered Plastics (1-800-682-2525) or equivalent product approved prior project award.
- E. Dimensions: The tile shall incorporate an in-line pattern of truncated domes measuring nominal 0.2" height, 0.9" base diameter, 0.45" top diameter spaced center-to-center 2.35" as measured on a diagonal and 1.67" as measured side by side in-line; except for tiles installed in California. Tiles installed in California shall incorporate an in-line pattern of truncated domes measuring nominal 0.2" height, 0.9" base diameter, 0.45" top diameter spaced center-to-center 2.35" as measured side by side in-line as required by the California Building Code, Title 24. For wheelchair safety the field area shall consist of a non-slip surface with a minimum of 40 - 90° raised points 0.045" high, per square inch. Cast in Place Warning tiles shall be held within the following dimensions and tolerances:

Part No.	Size [in x in]
ADA-C-1212	12 x 12
ADA-C-2424	24 x 24
ADA-C-2436	24 x 36
ADA-C-2448	24 x 48
ADA-C-2460	24 x 60
ADA-C-3648W	36 x 48
ADA-C-3660W	36 x 60
<i>Note: Dimensional tolerances ± 5%</i>	

- F. Product Data: Vitrified Polymer Composite (VPC) Cast in Place Warning tiles shall meet or exceed the following test criteria:

ASTM Reference	Test Description	Value
ASTM D 695	Compressive Strength	≥ 28,000 psi
ASTM D 790	Flexural Strength	≥ 25,000 psi
ASTM D 638	Tensile Strength	≥ 19,000 psi
ASTM D 5420	Impact Resistance	≥ 550 in-lbf/in
ASTM D 696	Coefficient of Thermal Expansion	2.78 x 10 ⁻⁶ /°F

ASTM C 1028	Static Coefficient of Friction	≥ 0.80
ASTM E 84	Flame Spread Index	≤ 25
ASTM D 570	Water Absorption	≤ 0.05%
ASTM C 501	Abrasive Wear Index Iw	≥ 500
ASTM D 2486	Abrasive Scrub Test	≤ 0.06
ASTM B 117	Salt Spray (300 hrs)	No Failure
ASTM D 1037	Accelerated Aging Cycle Testing	No Failure
ASTM D 543	Chemical Resistance	No Failure
ASTM G 155	Accelerated Weathering	ΔE < 3

1.05 DELIVERY, STORAGE AND HANDLING

- A. Cast in Place Warning tiles shall be suitably packaged or crated to prevent damage in shipment and handling. Finished surfaces shall be protected by sturdy plastic wrappings to protect tile from concrete residue during installation and tile type shall be identified by part number.
- B. Cast in Place Warning tiles shall be delivered to location at building site for storage prior to installation.

1.06 SITE CONDITIONS

- A. Environmental Conditions and Protection: Maintain minimum temperature of 41°F in spaces to receive Cast in Place Warning tiles for at least 24 hours prior to installation, during installation, and for not less than 24 hours after installation.
- B. The use of water for work, cleaning or dust control, etc. shall be contained and controlled and shall not be allowed to come into contact with the general public. Provide barricades or screens to protect the general public.

1.07 MANUFACTURER'S WARRANTY

- A. Cast in Place Warning tile shall be warranted in writing for a period of five (5) years from date of substantial completion. The guarantee includes factory defects, breakage, and deformation.

1.08 INSTALLATION WARRANTY

- A. Cast in Place Warning tile installation shall be warranted in writing for a period of two (2) years. Alternate products approved during the tendering process must be guaranteed for an additional three (3) years. Product must be guaranteed from defective work.

PART 2 PRODUCTS

2.01 MANUFACTURERS

- A. The Vitrified Polymer Composite (VPC) Cast in Place Detectable/Tactile Warning Surface tile specified is based on Armor Tile as distributed under license by Engineered Plastics Inc. (1-800-682-2525). Existing engineered and field tested products, which have been in successful service for a period of three (3) years are subject to compliance with requirements, may be incorporated in the work and shall meet or exceed the specified test criteria and characteristics.
- B. Color: Color shall be homogeneous throughout the tile.

Color	Federal Color No.
Federal Yellow	33538
Light Gray	26280
Dark Gray	36118
Onyx Black	17038
Pearl White	37835
Brick Red	22144
Ocean Blue	15817
Ochre Yellow	23594
Colonial Red (Brown)	20109

PART 3 EXECUTION

3.01 INSTALLATION

- A. During Cast in Place Detectable/Tactile Warning Surface tile installation procedures, ensure adequate safety guidelines are in place and that they are in accordance with the applicable industry and government standards.
- B. Prior to placement of the Cast in Place Warning tile system, review manufacturer and contract drawings with the Contractor prior to the construction and refer any and all discrepancies to the Engineer.
- C. The specifications of the structural embedment flange system and related materials shall be in strict accordance with the contract documents and the guidelines set by their respective manufacturers. Not recommended for asphalt applications.
- D. The physical characteristics of the concrete shall be consistent with the contract specifications while maintaining a slump range of 4 – 7 inches to permit solid placement of the Cast in Place

Warning tile system. An overly wet mix may cause the tile to float. Under these conditions, suitable weights such as 2 concrete blocks or 25 lb sandbags shall be placed on each tile.

- E. The concrete pouring and finishing operations require typical mason's tools, however, a 4' long level with electronic slope readout, 25 lb weights, and a large non-marring rubber mallet are specific to the installation of the Cast in Place Warning tile system. A vibrating mechanism such as that manufactured by Vibco can be employed, if desired. The vibrating unit should be fixed to a soft base such as wood, at least 1 foot square.
- F. The factory-installed plastic sheeting must remain in place during the entire installation process to prevent the splashing of concrete onto the finished surface of the tile.
- G. When preparing to set the tile, it is important that no concrete be removed in the area to accept the tile. It is imperative that the installation technique eliminates any air voids under the tile. Holes in the tile perimeter allow air to escape during the installation process. Concrete will flow through the large holes in each embedment flange on the underside of the tile. This will lock the tile solidly into the cured concrete.
- H. The concrete shall be poured and finished true and smooth to the required dimensions and slope prior to the tile placement. Immediately after finishing concrete, the electronic level should be used to check that the required slope is achieved. The tile shall be placed true and square to the curb edge in accordance with the contract drawings. The Cast in Place Warning tiles shall be tamped (or vibrated) into the fresh concrete to ensure that the field level of the tile is flush to the adjacent concrete surface. The embedment process should not be accomplished by stepping on the tile as this may cause uneven setting which can result in air voids under the tile surface. The contract drawings indicate that the tile field level (base of truncated dome) is flush to adjacent surfaces to permit proper water drainage and eliminate tripping hazards between adjacent finishes.
- I. In cold weather climates it is recommended that the Cast In Place Warning tiles be set deeper such that the top of domes are level to the adjacent concrete on the top and sides of ramp and that the base of domes to allow water drainage. This installation will reduce the possibility of damage due to snow clearing operations.
- J. Immediately after placement, the tile elevation is to be checked to adjacent concrete. The elevation and slope should be set consistent with contract drawings to permit water drainage to curb as the design dictates. Ensure that the field surface of the tile is flush with the surrounding concrete and back of curb so that no ponding is possible on the tile at the back side of curb.
- K. While concrete is workable, a 3/8" radius edging tool shall be used to create a finished edge of concrete, then a steel trowel shall be used to finish the concrete around the tile's perimeter, flush to the field level of the tile.
- L. During and after the tile installation and the concrete curing stage, it is imperative that there is no walking, leaning or external forces placed on the tile that may rock the tile causing a void between the underside of tile and concrete.
- M. Following tile placement, review installation tolerances to contract drawings and adjust tile before the concrete sets. Two suitable weights of 25 lb each may be required to be placed on each tile as necessary to ensure solid contact of the underside of tile to concrete.
- N. Following the concrete curing stage, protective plastic wrap is to be removed from the tile surface by cutting the plastic with a sharp knife, tight to the concrete/tile interface. If concrete

bled under the plastic, a soft brass wire brush will clean the residue without damage to the tile surface.

- O. If desired, individual tiles can be bolted together using 1/4" or equivalent hardware. This can help to ensure that adjacent tiles are flush to each other during the installation process. Tape or caulking can be placed on the underside of the bolted butt joint to ensure that concrete does not rise up between the tiles during installation. Any protective plastic wrap which was peeled back to facilitate bolting or cutting, should be replaced and taped to ensure that the tile surface remains free of concrete during the installation process.

3.02 CLEANING, PROTECTING AND MAINTENANCE

- A. Protect tiles against damage during construction period to comply with Warning tile manufacturer's specification.
- B. Protect tiles against damage from rolling loads following installation by covering with plywood or hardwood.
- C. Clean tiles not more than four days prior to date scheduled for inspection intended to establish date of substantial completion in each area of project. Clean tile by method specified by tile manufacturer.
- D. Comply with manufacturer's maintenance manual for cleaning and maintaining tile surface and it is recommended to perform annual inspections for safety and integrity.

END OF SECTION

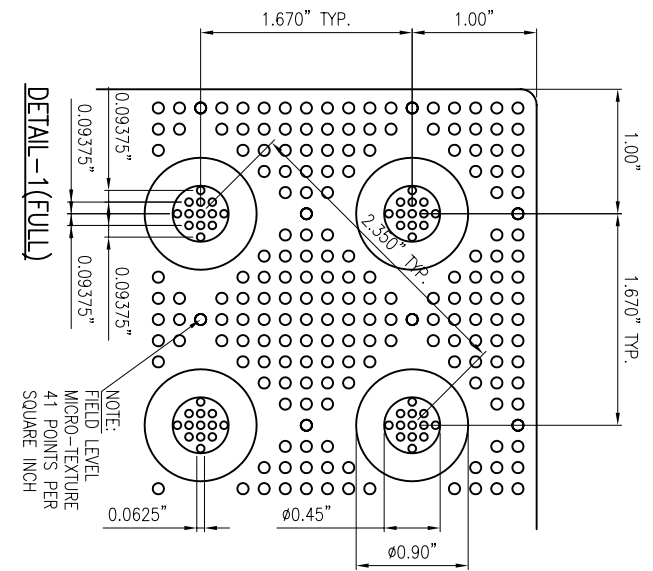
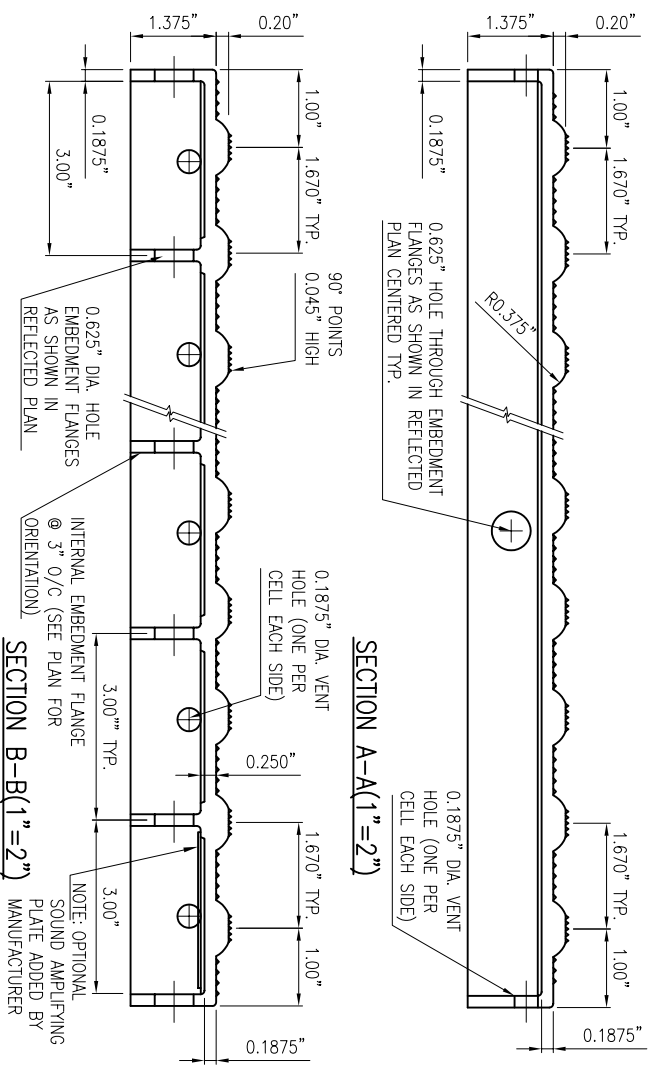
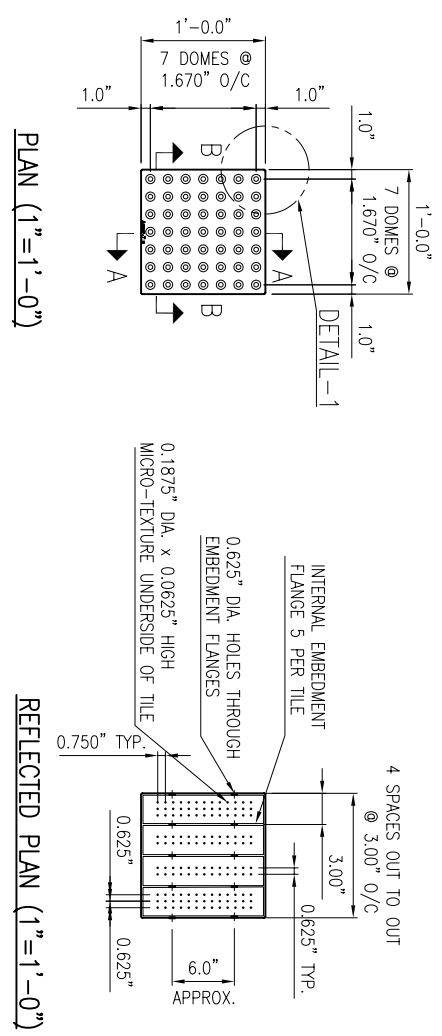

WWW. **Armor - Tile**.COM
GP ENGINEERED PLASTICS

© 2006 ENGINEERED PLASTICS
 CONFIDENTIAL AND PROPRIETARY DOCUMENT
 ANY ONE OR MORE OF THE FOLLOWING PATENTS MAY APPLY
 U.S. PATENT NO. 5,303,669, 5,775,835, 6,449,790, AND 6,995,622 B5
 C.O.M. PATENT NO. 2,032,532, 2,070,984
 US PATENTS PENDING.
 © KENNETH E. SEZKELY

#	DESCRIPTION	PART NO.	QTY
1	ARMOR-TILE	ADA-C-1212-**	1

MATERIAL LIST

** COLOR CODE
 YELLOW (YW), RED (RD), BLACK (BK), DARK GRAY (DG), LIGHT GRAY (LG), WHITE (WH), COBALT YELLOW (CY), BLUE (BL), ORANGE (OR), CUSTOM COLORS AVAILABLE

No.	DATE	REVISION	APPR.

SCALE

DESIGNED BY: K.S. DATE: 08/90
 DRAWN BY: D.C. DATE: 2/22/2006

PROJECT NUMBER: PART No.:

TITLE: DETECTABLE WARNING SURFACE ADA-C-1212-**

WORK: WETRIEFD POLYMER COMPOSITE

SUBJECT: **Armor - Tile™ ADA**
 SOUND AMPLIFYING DETECTABLE/TACTILE WARNING SURFACE TILE

PROJECT: **Armor - Tile™**
 DETECTABLE/TACTILE WARNING SURFACE TILE
 12" x 12" CAST IN PLACE INLINE DOME/TACTILE TILE PLANS AND DETAILS

DRAWING No: ADA-C-1212 REV. No: 0

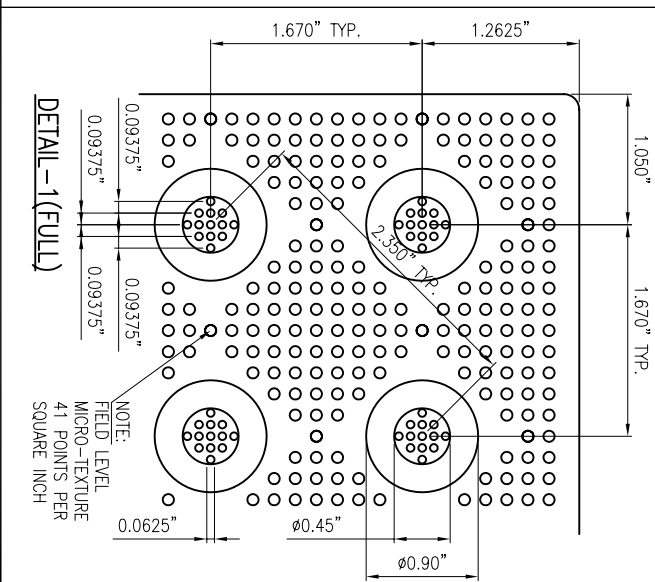
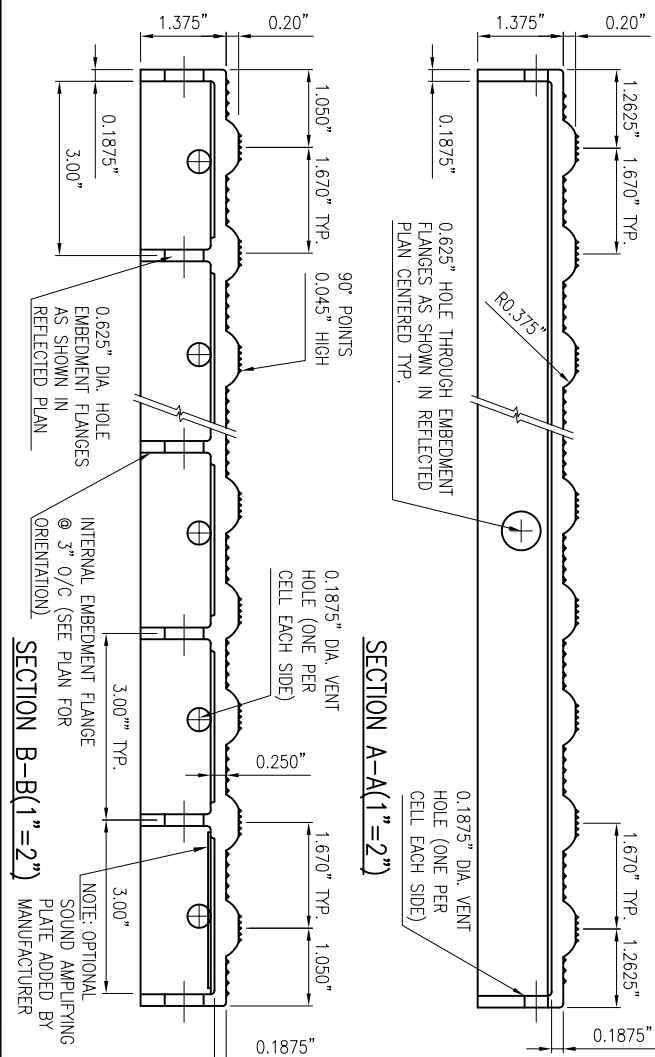
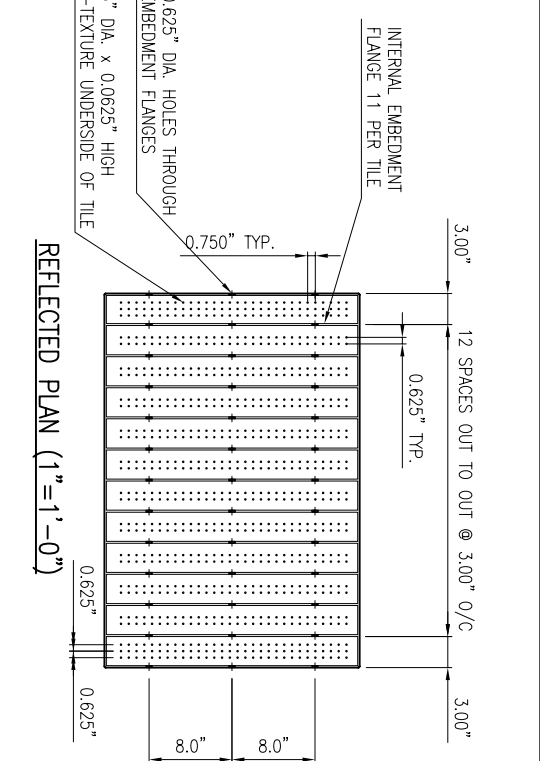
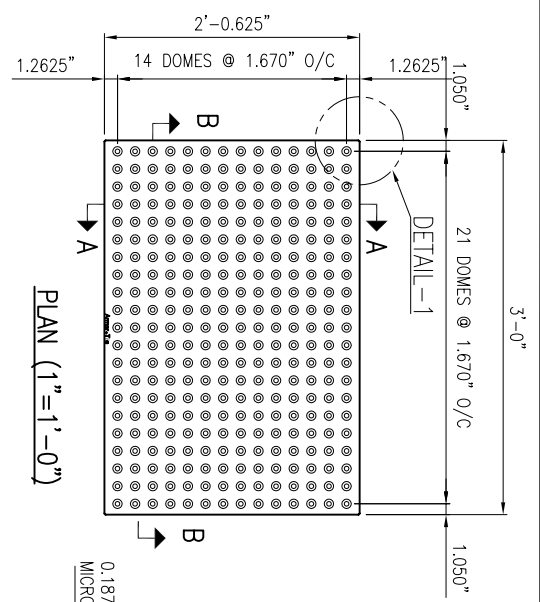

WWW.ARMOR-TILE.COM



© 2006 ENGINEERED PLASTICS
 CONFIDENTIAL AND PROPRIETARY DOCUMENT
 ANY ONE OR MORE OF THE FOLLOWING PATENTS MAY APPLY
 U. S. PATENT NO. 5,303,669, 5,775,835, 6,449,790, AND 6,995,622 B5
 C.D.M. PATENT NO. 2,032,532, 2,070,984
 US PATENTS PENDING.
 © KENNETH E. SEZELKY

MATERIAL LIST

#	DESCRIPTION	PART NO.	QTY
1	ARMOR-TILE	ADA-C-2436-**	1

** COLOR CODE
 YELLOW (YW), RED (RD), BLACK (BK),
 DARK GRAY (DG), LIGHT GRAY (LG),
 WHITE (WH), COBALT YELLOW (CY),
 BROWN (BR), CUSTOM (CN)
 CUSTOM COLORS AVAILABLE

No.	DATE	REVISION	APPR.

SCALE	DESIGNED	BY	DATE
		K.S.	08/90
		D.G.	2/22/2006

PROJECT NUMBER	PART No.

TITLE: DETECTABLE WARNING SURFACE ADA-C-2436-**
 MTD/K: WTRIFIED POLYMER COMPOSITE
 SUBJECT: **Armor - Tile™ ADA**
 SOUND AMPLIFYING DETECTABLE/TACTILE WARNING SURFACE TILE

Armor - Tile™
 DETECTABLE/TACTILE WARNING SURFACE TILE
 24" x 36" CAST IN PLACE
 INLINE DOME TACTILE TILE
 PLANS AND DETAILS
 DRAWING No: ADA-C-2436
 REV. No: 0

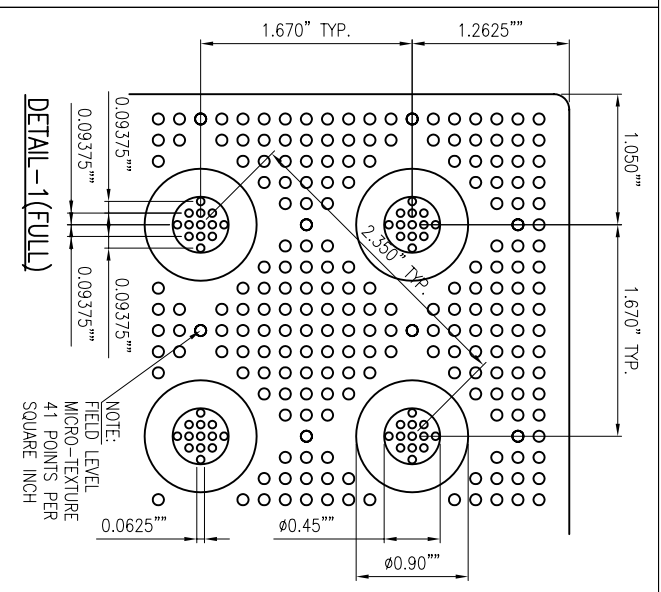
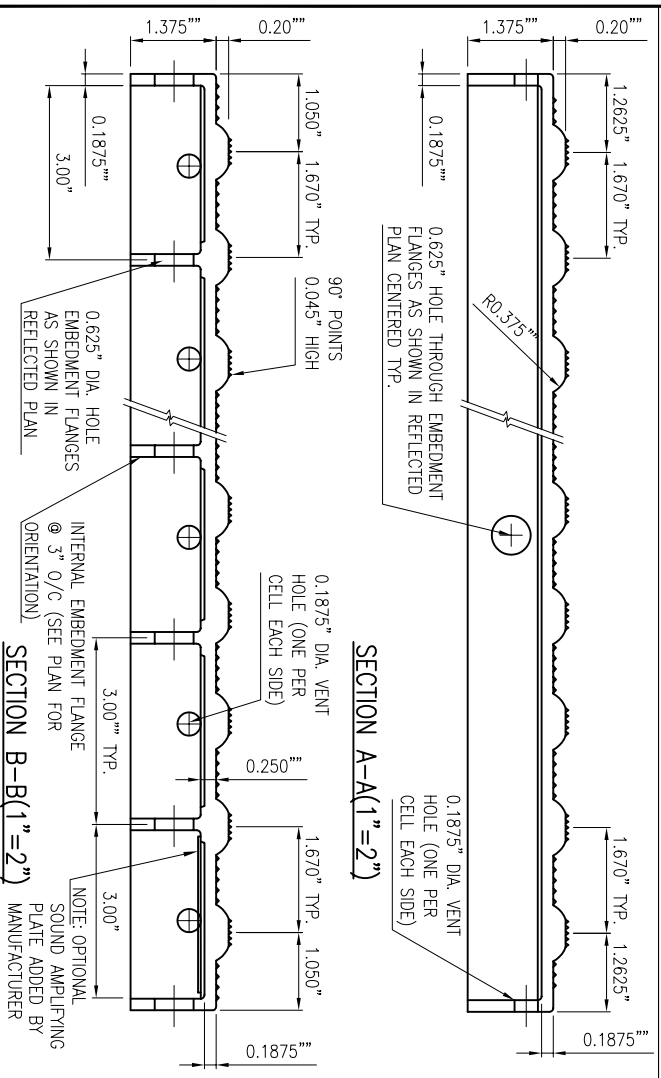
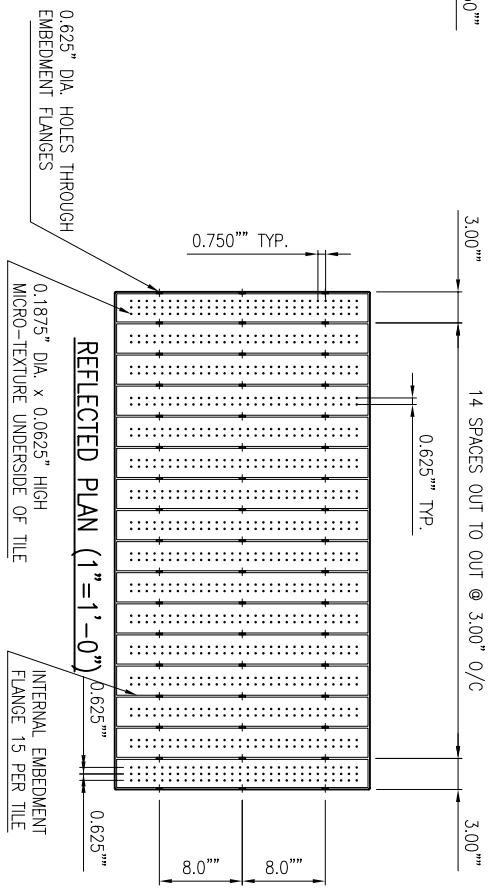
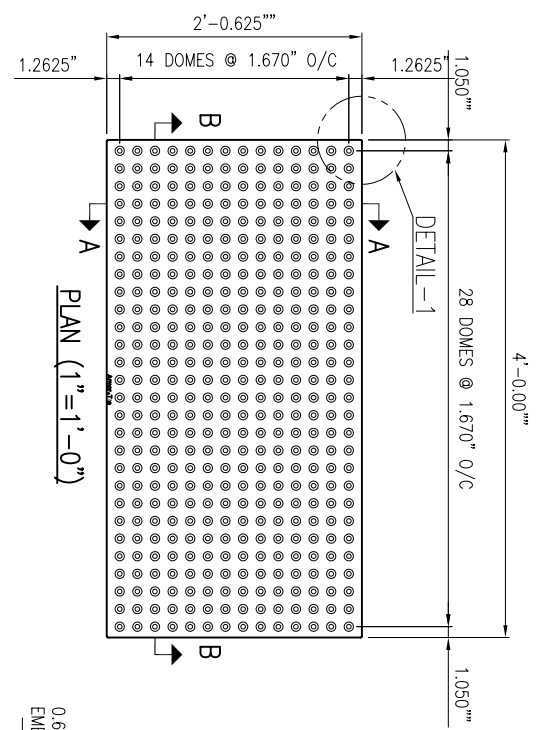

WWW.Armor-Tile.COM
ENGINEERED PLASTICS

© 2006 ENGINEERED PLASTICS
CONFIDENTIAL AND PROPRIETARY DOCUMENT
ANY ONE OR MORE OF THE FOLLOWING PATENTS MAY APPLY
U. S. PATENT NO. 5,303,669, 5,775,835, 6,449,790, AND 6,995,622 B5
C.D.M. PATENT NO. 2,032,532, 2,070,984
US PATENTS PENDING.
© KENNETH E. SZEKELY

#	DESCRIPTION	PART NO.	QTY
1	ARMOR-TILE	ADA-0-2448-**	1

MATERIAL LIST

** COLOR CODE
YELLOW (YW), RED (RD), BLACK (BK), DARK GRAY (DG), LIGHT GRAY (LG), WHITE (WH), COBALT FLECK (CF), BLUE (BL), ORANGE FLECK (OR)
CUSTOM COLORS AVAILABLE

No.	DATE	REVISION	APPR.

SCALE

DESIGNED BY: K.S. DATE: 08/90
DRAWN BY: D.C. DATE: 2/22/2006

PROJECT NUMBER: PART No.:
TILE: DETECTABLE WARNING SURFACE ADA-C-2448-**
MATERIAL: WETRIEDED POLYMER COMPOSITE
SUBJECT: ARMOR-TILE™ ADA SOUND AMPLIFYING DETECTABLE/TACTILE WARNING SURFACE TILE

Product: **Armor - Tile™ ADA**
DETECTABLE/TACTILE WARNING SURFACE TILE
24" x 48" CAST IN PLACE
INLINE DOME TACTILE TILE
PLANS AND DETAILS

DRAWING No: ADA-C-2448
REV. No: 0



© 2006 ENGINEERED PLASTICS
 CONFIDENTIAL AND PROPRIETARY DOCUMENT
 ANY ONE OR MORE OF THE FOLLOWING
 PATENTS MAY APPLY
 U. S. PATENT NO. 5,303,669; 5,775,835,
 6,449,790, AND 6,895,622 BS
 C.D.N. PATENT NO. 2,032,522, 2,070,984
 US PATENTS PENDING.
 © KENNETH E. SZEKELY

MATERIAL LIST

#	DESCRIPTION	PART No.	QTY
1	ARMOR-TILE	ADA-C-3648W**	1

** COLOR CODE
 YELLOW (YW), RED (RD), BLACK (BK),
 DARK GRAY (DG), LIGHT GRAY (LG),
 WHITE (WH), OCHRE YELLOW (OC),
 BLUE (BL), COLONIAL RED (CR)
 CUSTOM COLORS AVAILABLE

1.	2/27/2013	Confirmed compliance	K.S.
No.:	DATE	REVISION	APPR.

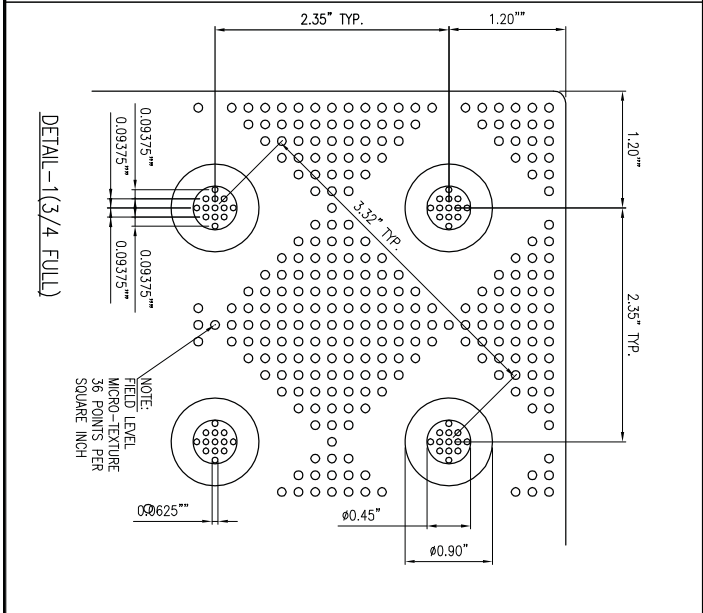
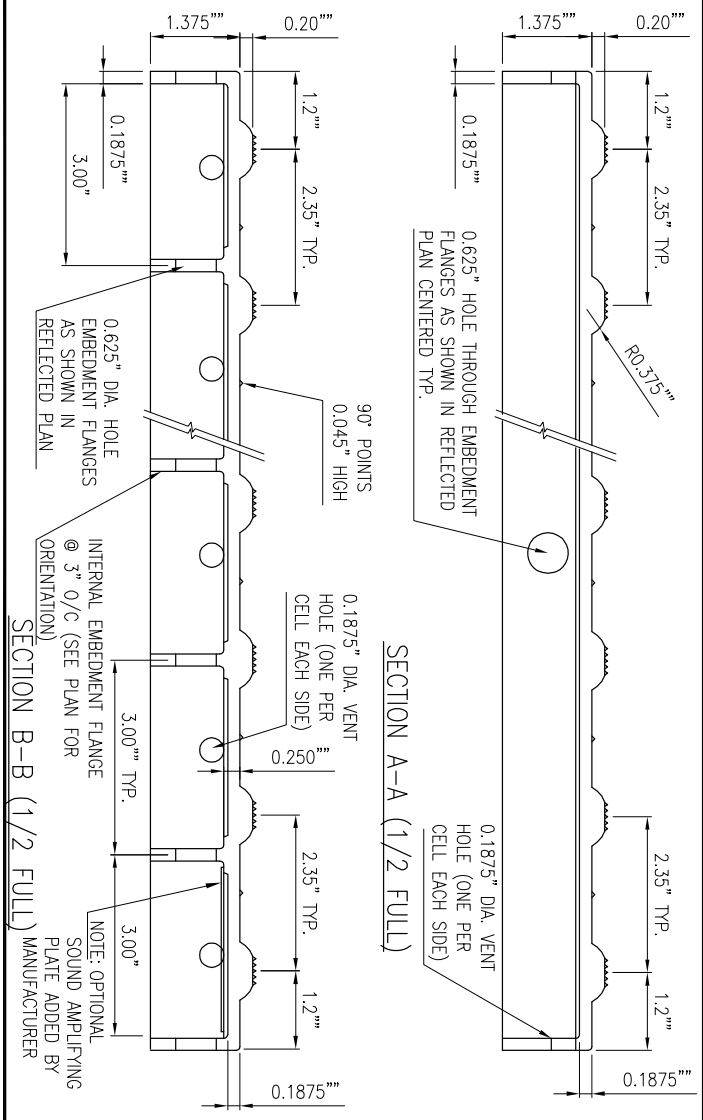
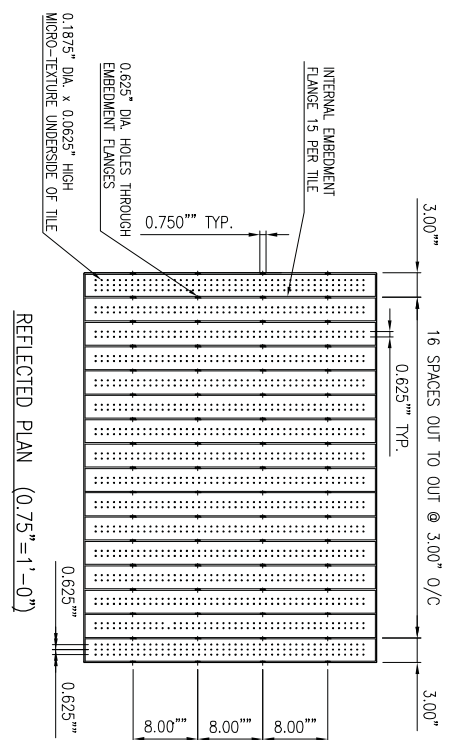
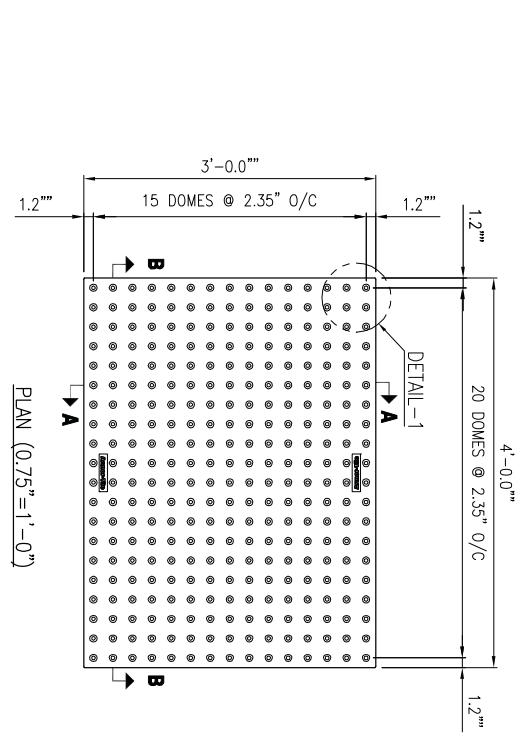

DESIGNED	BY	DATE	
DRAWN	K.S.	08/90	
CHECKED	D.G.	2/22/2006	
PROJECT NUMBER			
TITLE	PART No.		
DETECTABLE WARNING SURFACE	ADA-C-3648W**		
MATERIAL			
SUBJECT			
Armor - tile™ ADA			
SOUND AMPLIFYING DETECTABLE/TACTILE WARNING SURFACE TILE			
Armor - tile™			
DETECTABLE/TACTILE WARNING SURFACE TILE			
36" x 48" CAST IN PLACE INLINE DOME TACTILE TILE PLANS AND DETAILS			
DRAWING No.	ADA-C-3648W	REV. No.	0



© 2006 ENGINEERED PLASTICS
 CONFIDENTIAL AND PROPRIETARY DOCUMENT
 ANY ONE OR MORE OF THE FOLLOWING
 PATENTS MAY APPLY
 U. S. PATENT NO. 5,303,669; 5,775,835,
 6,449,790, AND 6,895,622 BS
 C.D.N. PATENT NO. 2,032,522, 2,070,984
 US PATENTS PENDING.
 © KENNETH E. SZEKELY

MATERIAL LIST

#	DESCRIPTION	PART No.	QTY
1	ARMOR-TILE	ADA-C-3660W**	1

** COLOR CODE
 YELLOW (YW), RED (RD), BLACK (BK),
 DARK GRAY (DG), LIGHT GRAY (LG),
 WHITE (WH), OCHRE YELLOW (OC),
 BLUE (BL), COLONIAL RED (CR)
 CUSTOM COLORS AVAILABLE

No.	DATE	REVISION	APPR.
1.	2/27/2013	Original Compliance	K.S.

DESIGNED	BY	DATE
	K.S.	08/90

DRAWN	CHECKED	DATE
	D.G.	2/22/2006

PRODUCT NUMBER	TITLE	PART No.
ADA-C-3660W**	DETECTABLE WARNING SURFACE	ADA-C-3660W**

Armor - Tile™ ADA
 SOUND AMPLIFYING DETECTABLE/TACTILE
 WARNING SURFACE TILE

Armor - Tile™
 DETECTABLE/TACTILE
 WARNING SURFACE TILE
 36" x 60" CAST IN PLACE
 INLINE DOME TACTILE TILE
 PLANS AND DETAILS

DRAWING No. ADA-C-3660W
 REV. No. 0

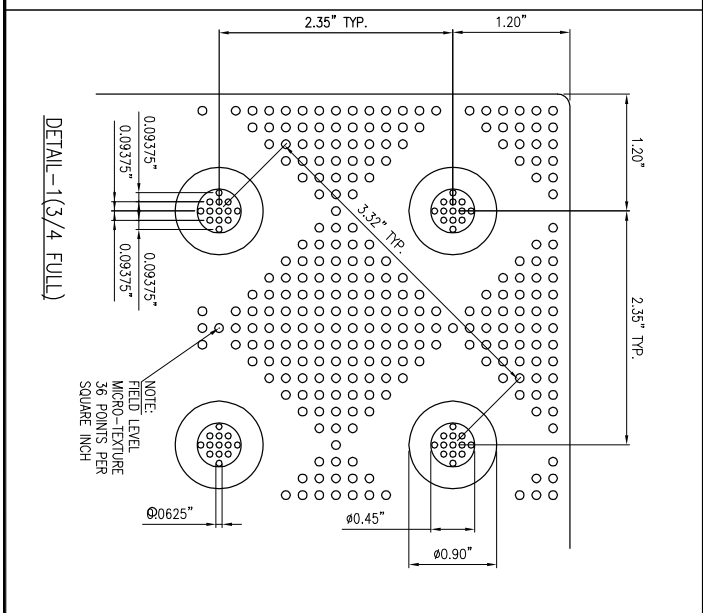
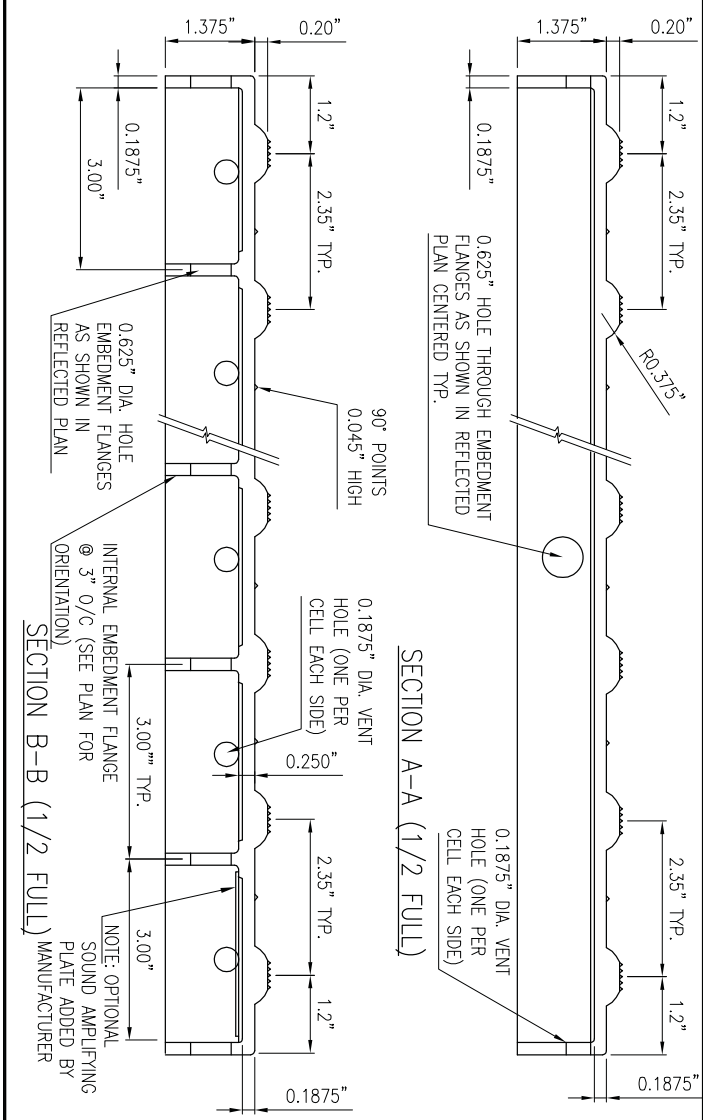
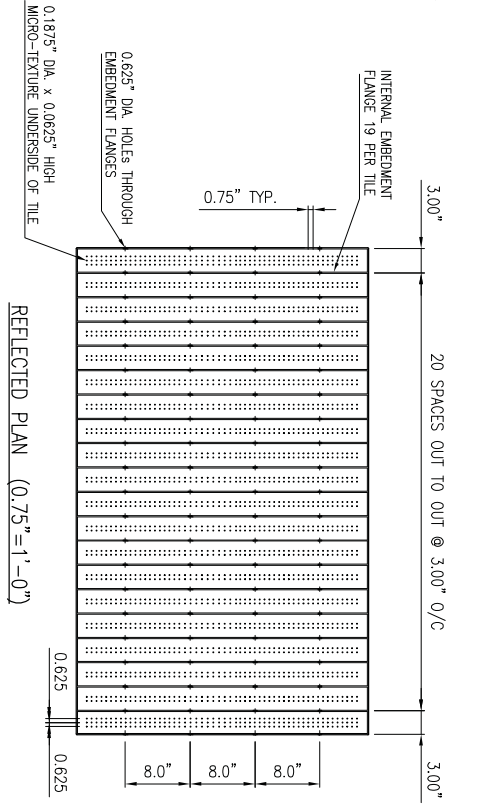
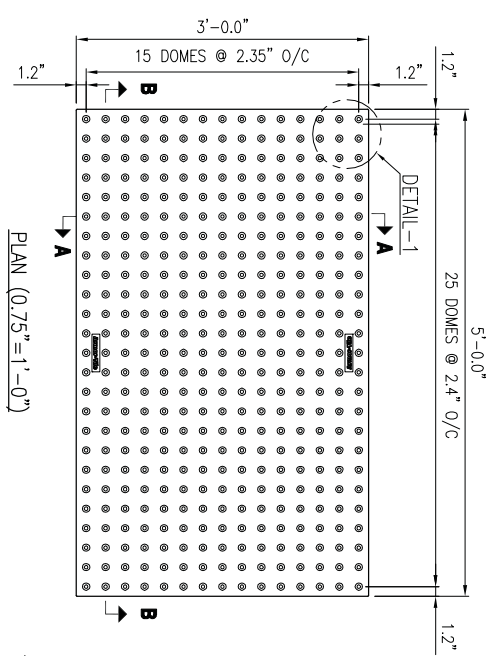

Installation Manual

Armor-Tile Cast In Place

Inline Dome Detectable/Tactile Warning Surface Tile

- A. During Cast In Place Detectable/Tactile Warning Surface Tile installation procedures, ensure adequate safety guidelines are in place and that they are in accordance with the applicable industry and government standards.
- B. The specifications of the structural embedment flange system and related materials shall be in strict accordance with the contract documents and the guidelines set by their respective manufacturers. Not recommended for asphalt applications.
- C. The physical characteristics of the concrete shall be consistent with the contract specifications while maintaining a slump range of 4 - 7 to permit solid placement of the Cast In Place Detectable/Tactile Warning Surface Tile system. An overly wet mix will cause the tile to float. Under these conditions, suitable weights such as 2 concrete blocks or sandbags (25 lb) shall be placed on each tile.
- D. Prior to placement of the Cast In Place Detectable/Tactile Warning Surface Tile system, the contract drawings shall be reviewed.
- E. The concrete pouring and finishing operations require typical mason's tools, however, a 4' long level with electronic slope readout, 25 lb. weights, and a large non-marring rubber mallet are specific to the installation of the Cast In Place Detectable/Tactile Warning Surface Tile system. A vibrating mechanism such as that manufactured by Vibco can be employed, if desired. The vibrating unit should be fixed to a soft base such as wood, at least 1 foot square.
- F. The factory-installed plastic sheeting must remain in place during the entire installation process to prevent the splashing of concrete onto the finished surface of the tile.
- G. When preparing to set the tile, it is important that NO concrete be removed in the area to accept the tile. It is imperative that the installation technique eliminates any air voids under the tile. Holes in the tile perimeter allow air to escape during the installation process. Concrete will flow through the large holes in each embedment flange on the underside of the tile. This will lock the tile solidly into the cured concrete.
- H. The concrete shall be poured and finished true and smooth to the required dimensions and slope prior to the tile placement. Immediately after finishing concrete, the electronic level should be used to check that the required slope is achieved. The tile shall be placed true and square to the curb edge in accordance with the contract drawings. The Cast In Place Detectable/Tactile Warning Surface Tiles shall be tamped (or vibrated) into the fresh concrete to ensure that the field level of the tile is flush to the adjacent concrete surface. The embedment process should not be accomplished by stepping on the tile as this may cause uneven setting which can result in air voids under the tile surface. The contract drawings indicate that the tile field level (base of truncated dome) is flush to adjacent surfaces to permit proper water drainage and eliminate tripping hazards between adjacent finishes.
- I. In cold weather climates it is recommended that the Cast In Place Detectable/Tactile Warning Surface Tiles be set deeper such that the top of domes are level to the adjacent concrete on the top and sides of ramp and that the base of domes to allow water drainage. This installation will reduce the possibility of damage due to snow clearing operations.
- J. Immediately after placement, the tile elevation is to be checked to adjacent concrete. The elevation and slope should be set consistent with contract drawings to permit water drainage to curb as the design dictates.
- K. While concrete is workable, a 3/8" radius edging tool shall be used to create a finished edge of concrete, then a steel trowel shall be used to finish the concrete around the tile's perimeter, flush to the field level of the tile.
- L. During and after the tile installation and the concrete curing stage, it is imperative that there is no walking, leaning or external forces placed on the tile that may rock the tile causing a void between the underside of tile and concrete.
- M. Following tile placement, review installation tolerances to contract drawings and adjust tile before the concrete sets. Two suitable weights of 25 lb each shall be placed on each tile as necessary to ensure solid contact of the underside of tile to concrete.
- N. Following the concrete curing stage, protective plastic wrap is to be removed from the tile surface by cutting the plastic with a sharp knife, tight to the concrete/tile interface. If concrete bled under the plastic, a soft brass wire brush will clean the residue without damage to the tile surface.
- O. If desired, individual tiles can be bolted together using 1/4 inch or equivalent hardware. This can help to ensure that adjacent tiles are flush to each other during the installation process. Tape or caulking can be placed on the underside of the bolted butt joint to ensure that concrete does not rise up between the tiles during installation. Any protective plastic wrap which was peeled back to facilitate bolting or cutting, should be replaced and taped to ensure that the tile surface remains free of concrete during the installation process.
- P. Tiles can be cut to custom sizes, or to make a radius, using a continuous rim diamond blade in a circular saw or mini-grinder. Use of a straightedge to guide the cut is advisable where appropriate.
- Q. Any sound-amplifying plates on the underside of the tile, which are dislodged during handling or cutting, should be replaced and secured with construction adhesive. The air gap created between these plates and the bottom of the tile is important in preserving the detectability properties of the Armor-Tile system as required in various jurisdictions.

Armor-Tile

Tactile Systems

Installation Instructions

Cast-In-Place Inline Dome Tile

View installation slide show, drawings and specifications on our website - www.armor-tile.com

Call 1-800-682-2525 if you have any questions

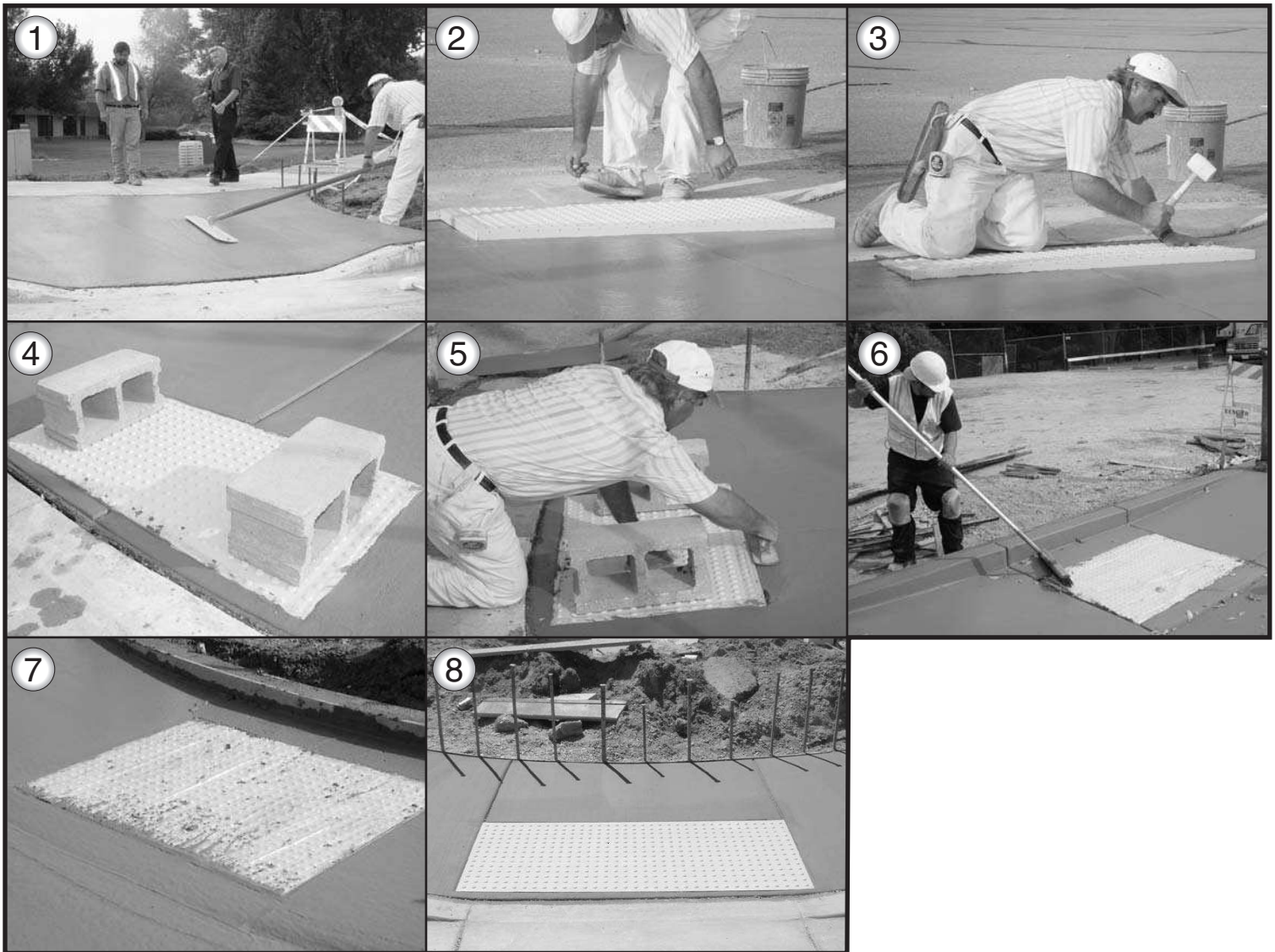

1. Maintaining a 4-7 slump range, pour and float the concrete.
2. Without removing any concrete, place the tile on the curb ramp 6"-8" from the curb line (face of curb).
3. Tamp the tile in grid pattern across the top face, embedding the tile into the concrete using a white or (non-marring) rubber mallet or vibrate into place using a vibrating mechanism fixed with a soft base such as wood, at least 1 foot square.
4. Place two cinder blocks or 25lb weights on the tile to prevent floating.
5. Create an edge around the perimeter of the tile using a 3/8" radius edging tool then float the concrete around the tile's perimeter using a steel trowel.
6. Apply a broom-finish to the curb ramp.
7. After the concrete has substantially cured, remove the protective plastic wrap by cutting the plastic with a sharp knife tight to the concrete/tile interface.
8. If concrete bled under the plastic, a soft wire brush will clean the residue without damage to the tile surface.



ENGINEERED PLASTICS INC.

300 International Dr., Suite 100, Williamsville, NY 14221 Tel: 1-800-682-2525 Fax: 1-800-769-4463

www.armor-tile.com

r1015

SURFACE APPLIED DETECTABLE/TACTILE WARNING SURFACE TILE

PART 1 GENERAL

1.01 RELATED DOCUMENTS

- A. Drawings and general provisions of Contract, including General and Special Conditions and Division 1 Specifications Section, apply to this Section.

1.02 DESCRIPTION

- A. This Section specifies furnishing and installing Surface Applied Detectable/Tactile Warning Surface Tiles where indicated.

1.03 SUBMITTALS

- A. Product Data: Submit manufacturer's literature describing products, installation procedures and routine maintenance.
- B. Samples for Verification Purposes: Submit one (1) 6" x 6" or 12"x12" size tile sample.
- C. Shop drawings are required for products specified showing fabrication details, composite structural system, tile surface profile, fastener locations, plans of tile placement including joints, and material to be used as well as outlining installation materials and procedure.
- D. Material Test Reports: Submit complete test reports from qualified accredited independent testing laboratories to qualify that materials proposed for use are in compliance with requirements and meet or exceed the properties indicated on the specifications. All tests shall be conducted on a Surface Applied Warning tile (or approved equal) as certified by a qualified independent testing laboratory.
- E. Maintenance Instructions: Submit copies of manufacturer's specified installation and maintenance practices for each type of Warning tile and accessory as required.

1.04 QUALITY ASSURANCE

- A. Provide Surface Applied Warning tiles and accessories as produced by a single manufacturer with a minimum of three (3) years' experience in the manufacturing of Surface Applied Warning tiles.
- B. Installer's Qualifications: Engage an experienced installer certified in writing by Surface Applied Warning tile manufacturer as qualified for installation, who has successfully completed installations similar in material, design, and extent to that indicated for the project.
- C. Provide Surface Applied Warning tiles which are in compliance with the following standards (or most recent):
 - a. Americans with Disabilities Act (Title III Regulations, 28 CFR Part 36 ADA STANDARDS FOR ACCESSIBLE DESIGN, Appendix A, Section 4.29.2 DETECTABLE WARNINGS ON WALKING SURFACES).
 - b. California Code of Regulations (CCR): Provide only approved DSAAC detectable warning products as provided in the California Code of Regulations (CCR) Title 24, Chapter 2,

Section 202 definition of "Detectable Warning". Section 11B-247 and 11B-705
 "Detectable Warnings And Detectable Directional Texture"

- D. Vitrified Polymer Composite (VPC) Surface Applied Warning tiles shall be an epoxy polymer composition with a ultra-violet coating employing aluminum oxide particles in the truncated domes; "Armor Tile" as distributed under license by Engineered Plastics (1-800-682-2525), or equivalent product approved prior project award.
- E. Dimensions: The tile shall incorporate an in-line pattern of truncated domes measuring nominal 0.2" height, 0.9" base diameter, 0.45" top diameter spaced center-to-center 2.35" as measured on a diagonal and 1.67" as measured side by side in-line; except for tiles installed in California. Tiles installed in California shall incorporate an in-line pattern of truncated domes measuring nominal 0.2" height, 0.9" base diameter, 0.45" top diameter spaced center-to-center 2.35" as measured side by side in-line as required by the California Building Code, Title 24. For wheelchair safety the field area shall consist of a non-slip surface with a minimum of 40 - 90° raised points 0.045" high, per square inch. Surface Applied Warning tiles shall be held within the following dimensions and tolerances:

Part No.	Size [in x in]
ADA-S-1212	12 x 12
ADA-S-2424	24 x 24
ADA-S-2436	24 x 36
ADA-S-2448	24 x 48
ADA-S-2460	24 x 60
ADA-S-3648W	36 x 48
ADA-S-3660W	36 x 60
<i>Note: Dimensional tolerances ± 5%</i>	

- F. Product Data: Vitrified Polymer Composite (VPC) Surface Applied Warning tiles shall meet or exceed the following test criteria:

Test Reference	Test Description	Value
AASHTO-HS 20	Wheel Load Tests	No Failure
ASTM D 695	Compressive Strength	≥ 28,000 psi
ASTM D 790	Flexural Strength	≥ 25,000 psi
ASTM D 638	Tensile Strength	≥ 19,000 psi
ASTM D 5420	Impact Resistance	≥ 550 in-lbf/in

ASTM D 696	Coefficient of Thermal Expansion	$2.78 \times 10^{-6} / ^\circ\text{F}$
ASTM C 1028	Static Coefficient of Friction	≥ 0.80
ASTM E 84	Flame Spread Index	≤ 25
ASTM D 570	Water Absorption	$\leq 0.05\%$
ASTM C 501	Abrasive Wear Index Iw	≥ 500
ASTM D 2486	Abrasive Scrub Test	≤ 0.06
ASTM B 117	Salt Spray (300 hrs)	No Failure
ASTM D 1037	Accelerated Aging Cycle Testing	No Failure
ASTM D 543	Chemical Resistance	No Failure
ASTM G 155	Accelerated Weathering	$\Delta E < 3$

1.05 DELIVERY, STORAGE AND HANDLING

- A. Surface Applied Warning tiles shall be suitably packaged or crated to prevent damage in shipment and handling.
- B. Surface Applied Warning tiles shall be delivered to location at building site for storage prior to installation.

1.06 SITE CONDITIONS

- A. Environmental Conditions and Protection: Maintain minimum temperature of 41°F in spaces to receive Surface Applied Warning tiles for at least 24 hours prior to installation, during installation, and for not less than 24 hours after installation.
- B. The use of water for work, cleaning or dust control, etc. shall be contained and controlled and shall not be allowed to come into contact with the general public. Provide barricades or screens to protect the general public.

1.07 MANUFACTURER'S WARRANTY

- A. Surface Applied Warning tiles shall be warranted in writing for a period of five (5) years from date of substantial completion. The guarantee includes factory defects, breakage, and deformation.

1.08 INSTALLATION WARRANTY

- A. Surface Applied Warning tile installation shall be warranted in writing for a period of two (2) years. Alternate products approved during the tendering process must be guaranteed for an additional three (3) years. Product must be guaranteed from defective work.

PART 2 PRODUCTS

2.01 MANUFACTURERS

- A. The Vitrified Polymer Composite (VPC) Surface Applied Detectable/Tactile Warning Surface Tile specified is based on Armor Tile as distributed under license by Engineered Plastics (1-800-682-2525). Existing engineered and field tested products, which have been in successful service for a period of three (3) years are subject to compliance with requirements, may be incorporated in the work and shall meet or exceed the specified test criteria and characteristics.
- B. Color: Color shall be homogeneous throughout the tile.

Color	Federal Color No.
Federal Yellow	33538
Light Gray	26280
Dark Gray	36118
Onyx Black	17038
Pearl White	37835
Brick Red	22144
Ocean Blue	15817
Ochre Yellow	23594
Colonial Red (Brown)	20109

2.02 MATERIALS

- A. Fasteners: Color matched sleeve (where appropriate), corrosion resistant, flat head drive anchor: ¼" diameter x 2" long Stainless Steel fastener as supplied by Engineered Plastics Inc..
- B. Adhesive: Tactile Bond and Seal (TBS) as supplied by Engineered Plastics Inc.
- C. Sealant: Tactile Bond and Seal (TBS) as supplied by Engineered Plastics Inc..

PART 3 EXECUTION

3.01 INSTALLATION

- A. During all surface preparation and installation procedures, ensure adequate safety guidelines are in place and that they are in accordance with the applicable industry and government standards.
- B. The application of all tiles, adhesives, mechanical fasteners, and caulking shall be in strict accordance with the guidelines set by their respective manufacturers. Not recommended direct asphalt applications.

- C. Coordinate with the Contractor or Engineer to ensure that the surfaces being prepared and fabricated to receive the tiles are constructed correctly and adequately for tile installation. Review manufacturer and contract drawings with the Contractor prior to the construction and refer any and all discrepancies to the Engineer.
- D. Set the tile true and square to the curb ramp area as detailed in the design drawings, so that its location can be marked on the concrete surface. A thin permanent marker works well. Remove tile when done marking its location.
- E. The surface to receive the Surface Applied Warning tile is to be mechanically cleaned with a diamond cup grinder or shot blaster to remove any dirt or foreign material. This cleaning and roughening of the concrete surface should include at least 4 inches around the perimeter of the area to receive the tile, and also along the cross pattern established by the corresponding areas on the backside of the tile. Those same areas should then be cleaned with a clean rag soaked in Acetone ensuring all dust and debris are removed.
- F. Immediately prior to installing the Surface Applied Warning tile, the concrete surfaces must be inspected to ensure that they are clean, dry, free of voids, curing compounds, projections, loose material, dust, oil, grease, sealers and determined to be structurally sound and cured for a minimum of 30 days.
- G. Using Acetone, wipe the backside of the tile around the perimeter and along the internal cross pattern, to remove any dirt or dust particles from the area to receive the adhesive.
- H. Apply TBS to the backside of the tile, following the perimeter and internal cross pattern established by the tile manufacturer. Sufficient adhesive must be placed on the prescribed areas to have full coverage across the 2" width of the adhesive locator and shall be applied to within ¼" continuously around the perimeter edge of the tile. The entire tube of adhesive shall be applied to the back of each tile, sizes 24 x 36 in. and greater.
- I. Set the tile true and square to the curb ramp area as detailed in the design drawings.
- J. Working from the center of the tile outwards, proceed to drill and install all fasteners in the tile's molded recesses.
- K. Standing with both feet applying pressure around the molded recess provided in the tile, drill a hole true and straight to a depth of 3 ½" using a ¼" masonry drill bit. Drill through the tile without hammer option (on the drill) until the tile has been successfully penetrated, then with hammer option (on the drill) to drill into the concrete. Maintaining foot pressure on both sides of the hole while drilling prevents concrete dust from accumulating between the tile and concrete which can affect the tile being installed flush and may compromise installation integrity.
- L. Immediately after drilling each hole, before moving on to the next, and while still applying foot pressure, mechanically fasten tiles to the concrete substrate using a leather bound or hard plastic mallet to set the fasteners. Ensure the fastener has been placed to full depth in the dome, straight, and flush to the top of dome. Drive the pin of the fastener with the mallet, taking care to avoid any inadvertent blows to the truncated dome or tile surface.
- M. Following the installation of the fasteners, the concrete dust should be vacuumed, brushed or blown away from the tile's surface and adjacent concrete. Using Acetone on a rag, wipe the concrete around the tile's perimeter to ensure a clean, dry surface to receive perimeter sealant.

- N. TBS perimeter caulking sealant should be applied following the sealant manufacturer's recommendations. Tape all perimeter edges of the tile back 1/16" from the tile's perimeter edge and tape the adjacent concrete back 1/2" from the tile's perimeter edge to maintain a straight and even caulking line. Apply sealant around tile perimeter using care to work sealant into any void between the tile and concrete interface. Tool the perimeter caulking with a rounded plastic applicator or spatula to create a cove profile between the tile and adjacent concrete. Remove tape immediately after tooling perimeter caulking sealant.
- O. Do not allow foot traffic on installed tiles until the perimeter caulking sealant has cured sufficiently to avoid tracking. Curing time is weather dependent (average cure time at 75° F is 30 minutes). Adhesive or caulking on the surface of the Armor-Tile can be removed with Acetone.
- P. If installing adjacent tiles, note the orientation of each tile. Careful attention will reveal that one of the long edges of the tile is different than the other in regard to the tiny dotted texture. You may also note a larger perimeter margin before the tiny dotted texture pattern begins. Consistent orientation of each Armor-Tile is required in order that the truncated domes on adjacent tiles line up with each other.
- Q. In order to maintain proper spacing between truncated domes on adjacent tiles refer to the drawings for correct installation. The use of a continuous rim Diamond blade and a straightedge to guide the cut if required. All cuts should be made prior to installation of the tiles. If installing adjacent tiles, care should be taken to leave a 1/8" gap between each tile to allow for expansion and contraction.
- R. If tiles are custom cut to size, if pre-molded recesses (to receive fasteners) are removed by the cut, or to maintain a tight installation to the substrate then any truncated dome can be center-drilled with a 1/4" masonry drill bit to create a through hole, and the through hole must be countersunk with a suitable carbide countersink bit to receive mechanical fasteners. Care should be taken to not countersink too widely or deeply. Fasteners should be flush with the top of the truncated dome when countersunk properly.

3.02 CLEANING, PROTECTING AND MAINTENANCE

- A. Protect tiles against damage during construction period to comply with Warning tile manufacturer's specification.
- B. Protect tiles against damage from rolling loads following installation by covering with plywood or hardwood.
- C. Clean tiles not more than four days prior to date scheduled for inspection intended to establish date of substantial completion in each area of project. Clean tile by method specified by tile manufacturer.
- D. Comply with manufacturer's maintenance manual for cleaning and maintaining tile surface and it is recommended to perform annual inspections for safety and integrity.

END OF SECTION

©2006 ENGINEERED PLASTICS
 CONFIDENTIAL AND PROPRIETARY DOCUMENT
 ANY ONE OR MORE OF THE FOLLOWING
 PATENTS MAY APPLY
 U. S. PATENT NO. 5,303,669, 5,775,835,
 6,449,790, AND 6,895,622 BS
 C.O.N. PATENT NO. 2,032,532, 2,070,984
 US PATENTS PENDING.
 DR. KENNETH E. SZEKELY

MATERIAL LIST

#	DESCRIPTION	PART No.	QTY
1	ARMOR-TILE	ADA-S-2424-**	1
2	EXPANSION ANCHOR	ADA-FAST	8
3	ARMOR-BOND	ADA-ADBE-EA	1
4	ARMOR-SEAL	ADA-SEAL-EA	1

** COLOR CODE
 YELLOW (YW), RED (RD), BLACK (BK),
 DARK GRAY (DG), LIGHT GRAY (LG),
 WHITE (WH), COFFEE YELLOW (CY),
 BLUE (BL), COGNAC RED (CR)
 CUSTOM COLORS AVAILABLE

No.	DATE	REVISION	APPR.

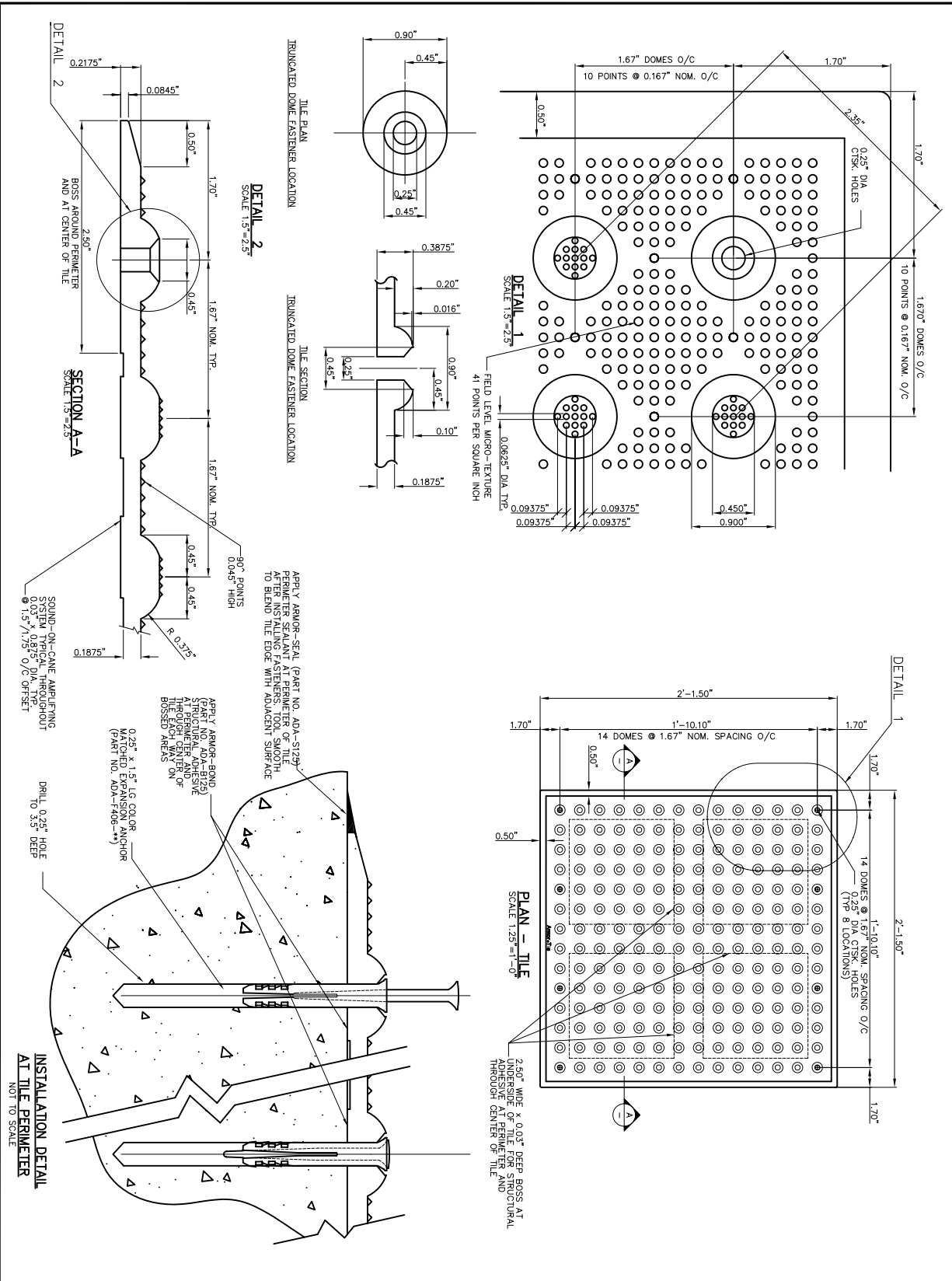

SCALE	DESIGNED BY	DATE
	K.S.	08/30
	D.G.	2/22/2006

PROJECT NUMBER	PART No.
	ADA-S-2424-**

TITLE	SUBJECT
DETAILED WARNING SURFACE ADA-S-2424-**	VITRIFIED POLYMER COMPOSITE

Armor-Tile™ ADA
 SOUND APPEARING DETECTABLE/TACTILE
 WARNING SURFACE TILE

Armor - Tile™
 DETECTABLE/TACTILE
 WARNING SURFACE TILE
 24" x 24" SURFACE APPLIED
 NINE-DOME TACTILE TILE
 PLANS AND DETAILS

PROJECT: ADA-S-2424

GRAPHIC No: ADA-S-2424

REV No: 0

© 2007 ENGINEERED PLASTICS CORPORATION AND PROPRIETARY DOCUMENT ANY ONE OR MORE OF THE FOLLOWING PATENTS MAY APPLY
 U.S. PATENT NO. 5,303,668; 5,775,535; 6,449,790; AND 6,886,622; 65; C.D.N. PATENT NO. 2,032,532; 2,070,984
 US PATENTS PENDING.
 © KENNETH E. SZERKELY

MATERIAL LIST

#	DESCRIPTION	PART No.	QTY
1	ARMOR-TILE	ADA-S-2448-**	1
2	EXPANSION ANCHOR	ADA-FAST	8
3	ARMOR-BOND	ADA-ADH-EA	1
4	ARMOR-SEAL	ADA-SEAL-EA	1

** COLOR CODE
 YELLOW (YW), RED (RD), BLACK (BK), DARK GRAY (DG), LIGHT GRAY (LG), WHITE (WH), OCHRE, TELLOW (OT), BLUE (BL), ORANGE, TEALON (TS), CUSTOM COLORS AVAILABLE

No:	DATE	REVISION	APPR.

SCALE

DESIGNED BY	DATE
FR K.S.	09/90
DRAWN BY	DATE
D.G.	08/02/2007
CHECKED BY	DATE

PROJECT NUMBER: PART No. ADA-S-2448-**

TITLE: DETECTABLE WARNING SURFACE ADA-S-2448-**
 MATERIAL: VITRIFIED POLYMER COMPOSITE

SUBJECT: **Armor-Tile™ ADA**
 SOUND AMPLIFYING DETECTABLE/TACTILE WARNING SURFACE TILE

PROJECT: **Armor-Tile™**
 DETECTABLE/TACTILE WARNING SURFACE TILE
 24" x 48" SURFACE APPLIED INLINE DETECTABLE TILE PLANS AND DETAILS

DRAWING No. ADA-S-2448 REV. No. 1

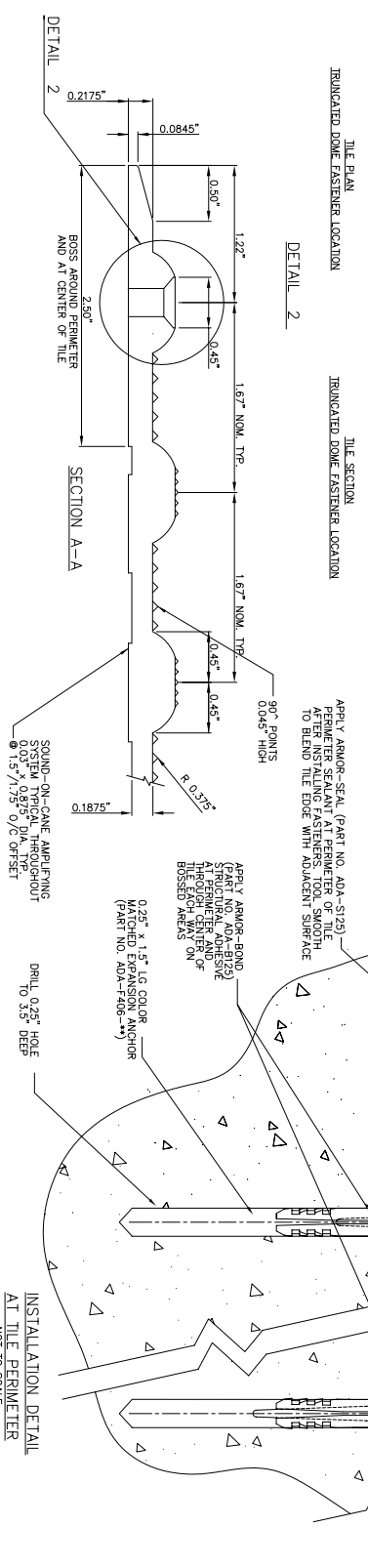
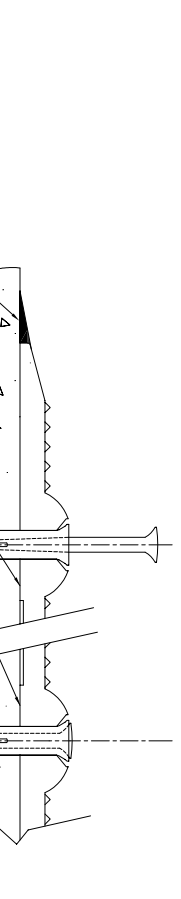
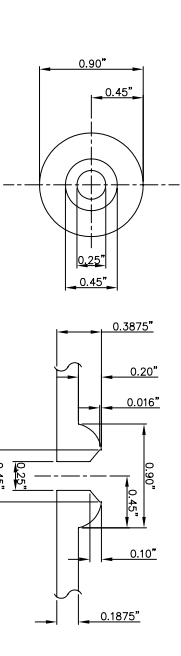
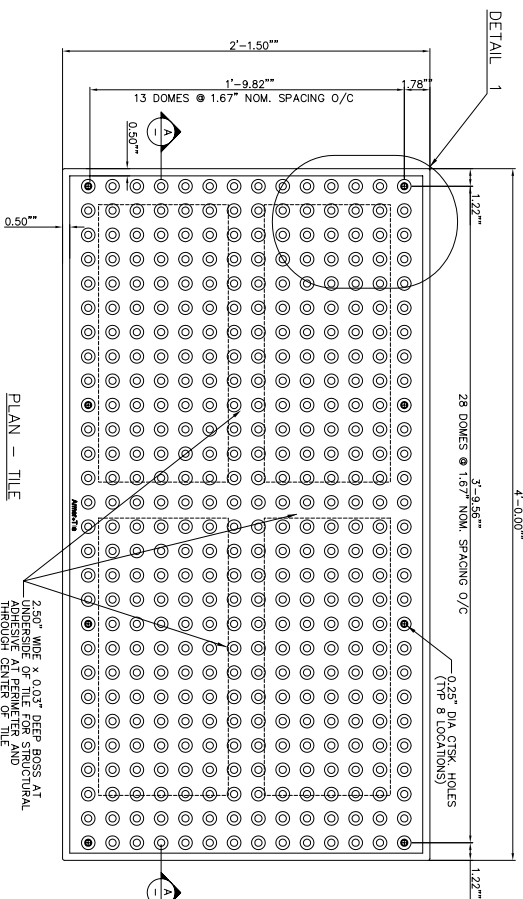
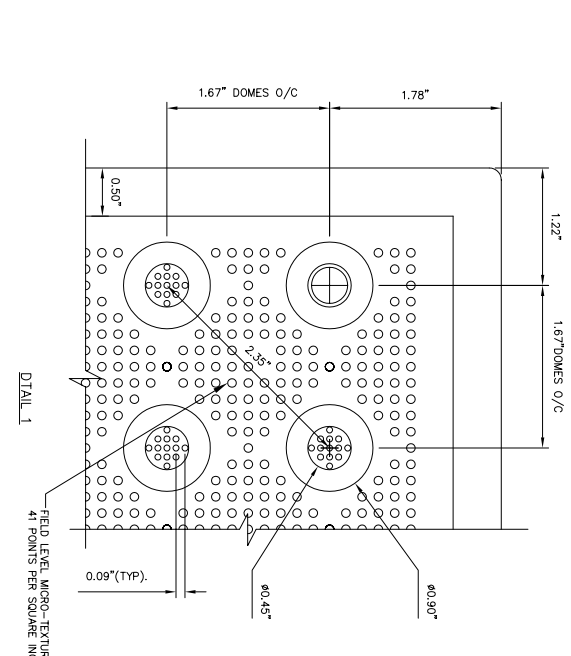

DETAIL 1

DETAIL 2

INSTALLATION DETAIL AT TILE PERIMETER NOT TO SCALE

© 2006 ENGINEERED PLASTICS
 CONFIDENTIAL AND PROPRIETARY DOCUMENT
 ANY ONE OR MORE OF THE FOLLOWING
 PATENTS MAY APPLY
 U. S. PATENT NO. 5,303,669, 5,775,835,
 6,449,790, AND 6,895,622 BS
 C.O.N. PATENT NO. 2,032,532, 2,070,984
 US PATENTS PENDING.
 DR. KENNETH E. SEZELNY

MATERIAL LIST

#	DESCRIPTION	PART No.	QTY
1	ARMOR-TILE	ADA-S-2460	1
2	EXPANSION ANCHOR	ADA-FAST	10
3	ARMOR-BOND	ADA-ADHE-EA	1
4	ARMOR-SEAL	ADA-SEAL-EA	1

** COLOR CODE
 YELLOW (YW), RED (RD), BLACK (BK),
 DARK GRAY (DG), LIGHT GRAY (LG),
 WHITE (WH), COBBLE YELLOW (CY),
 BLUE (BL), COGNAC RED (CR)
 CUSTOM COLORS AVAILABLE

No.	DATE	REVISION	APPR.

SCALE: 1.25"=1'-0"

REASONED BY: K.S. DATE: 08/30

DRAWN BY: D.G. DATE: 2/22/2006

CHECKED BY: [] DATE: []

PROJECT NUMBER: []

TITLE: DETECTABLE WARNING SURFACE ADA-S-2460-**

MATERIAL: VITRIFIED POLYMER COMPOSITE

SUBJECT: ARMOR-TILE™ ADA
 SOUND APPLICATING DETECTABLE/TACTILE
 WARNING SURFACE TILE

PRODUCT: ARMOR-TILE™
 DETECTABLE/TACTILE
 WARNING SURFACE TILE
 24" x 60" SURFACE APPLIED
 INLINE DOME TACTILE TILE
 PLANS AND DETAILS

DRAWING No: ADA-S-2460

REV No: 0

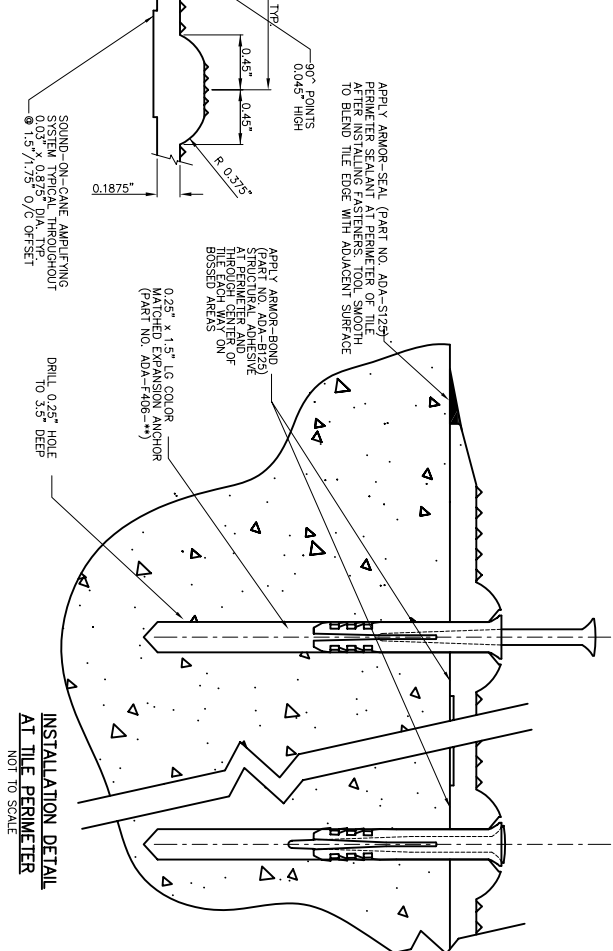
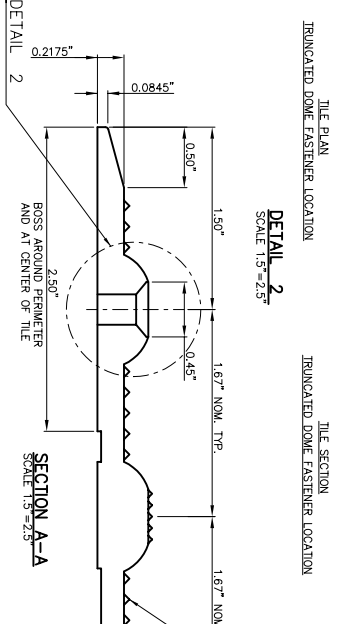
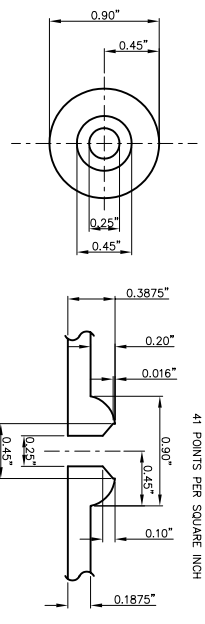
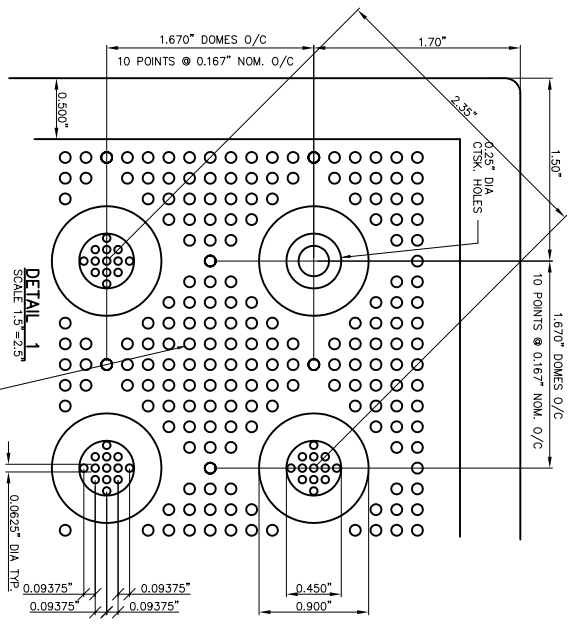
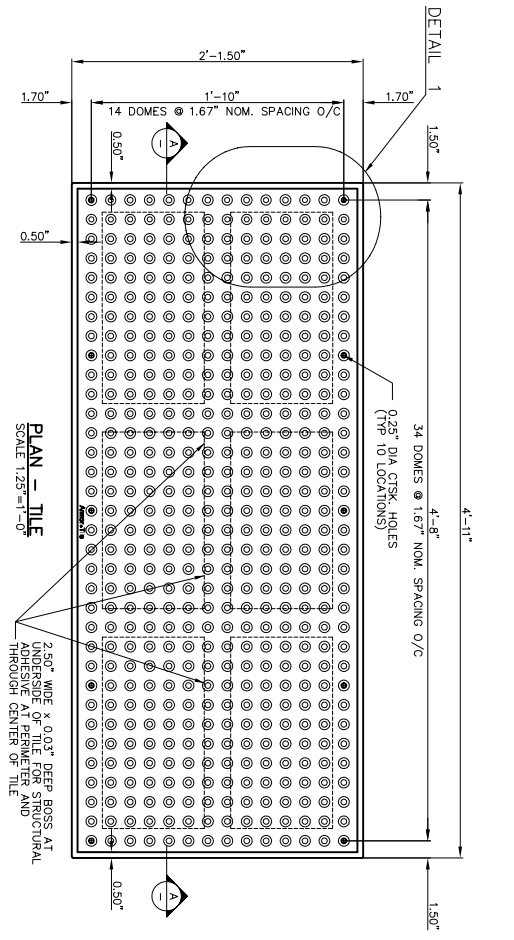



© 2013 ENGINEERED PLASTICS
 CONFIDENTIAL AND PROPRIETARY DOCUMENT
 ANY ONE OR MORE OF THE FOLLOWING
 PATENTS MAY APPLY
 U. S. PATENT NO. 5,303,669, 5,775,835,
 6,449,790, AND 6,895,622 B5
 C.D.N. PATENT NO. 2,032,532, 2,070,984
 US PATENTS PENDING.
 KENNETH E. SZEKELY

MATERIAL LIST			
#	DESCRIPTION	PART No.	QTY
1	ARMOR-TILE	ADA-S-3660-W	1
2	EXPANSION ANCHOR	ADA-S-ANCH	15
3	TACTILE BOND AND SEAL	TBS-010	2

** COLOR CODE
 YELLOW (YW), RED (RD), BLACK (BK),
 DARK GRAY (DG), LIGHT GRAY (LG),
 WHITE (WH), OCHRE, YELLOW (OY),
 BLUE (BL), COGNAC, RED (RS)
 CUSTOM COLORS AVAILABLE

No.	DATE	REVISION	APPR.

DESIGNED	BY	DATE
	K.S.	09/08/2013

PROJECT NUMBER	PART No.
	ADA-S-3660-W

TITLE: DETECTABLE WARNING SURFACE ADA-S-3660-W
 MATERIAL: VITRIFIED POLYMER COMPOSITE

PROJECT: **Armor - Tile™ ADA**
 SOUND AMPLIFYING DETECTABLE/TACTILE
 WARNING SURFACE TILE

Armor - Tile™
 DETECTABLE/TACTILE
 WARNING SURFACE TILE
 36" x 60" SURFACE APPLIED
 INLINE DOME TACTILE TILE
 PLANS AND DETAILS

DRAWING No.	REV. No.
ADA-S-3660W	0

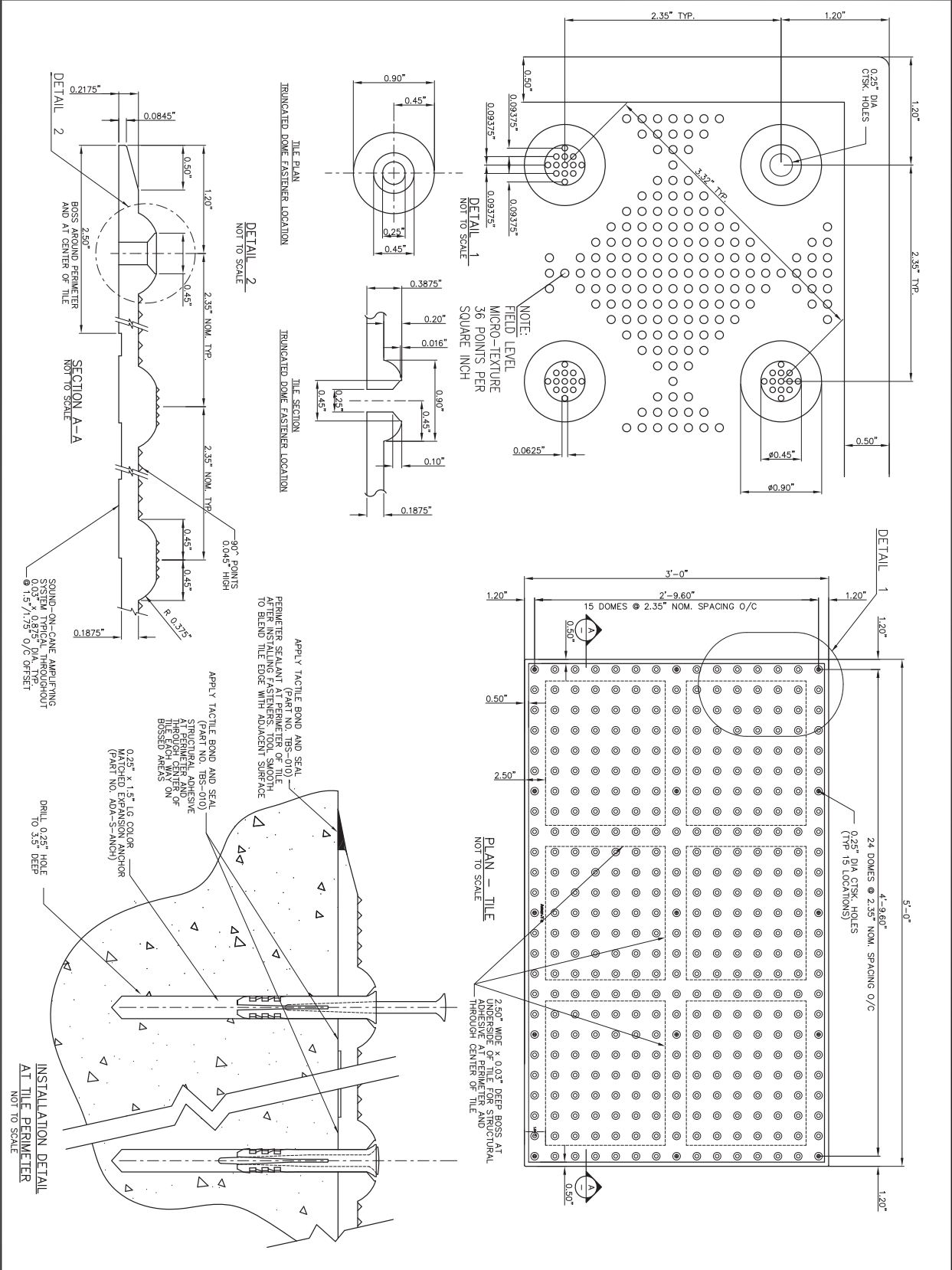

SCALE: AS SHOWN

Installation Manual Armor-Tile Surface Applied Inline Dome Detectable/ Tactile Warning Surface Tile

- A. During all surface preparation and Surface Applied Detectable/Tactile Warning Surface Tile installation procedures, ensure adequate safety guidelines are in place and that they are in accordance with the applicable industry and government standards.
- B. The application of all tiles, adhesives, mechanical fasteners, and caulking shall be in strict accordance with the guidelines set by their respective manufacturers. Not recommended for asphalt applications.
- C. Coordinate with the Contractor or Engineer to ensure that the surfaces being prepared and fabricated to receive the tiles are constructed correctly and adequately for tile installation. Review design drawings with the Contractor prior to the construction and refer any and all discrepancies to the Engineer.
- D. Set the tile true and square to the curb ramp area as detailed in the design drawings, so that its location can be marked on the concrete surface. A thin permanent marker works well. Remove tile when done marking its location.
- E. The surface to receive the Surface Applied Detectable/Tactile Warning Surface Tile is to be mechanically cleaned with a diamond cup grinder or shot blaster to remove any dirt or foreign material. This cleaning and roughening of the concrete surface should include at least 4 inches around the perimeter of the area to receive the tile, and also along the cross pattern established by the corresponding areas on the backside of the tile. Those same areas should then be cleaned with a clean rag soaked in Acetone.
- F. Immediately prior to installing the Surface Applied Detectable/Tactile Warning Surface Tile, the concrete surfaces must be inspected to ensure that they are clean, dry, free of voids, curing compounds, projections, loose material, dust, oil, grease, sealers and determined to be structurally sound and cured for a minimum of 30 days.
- G. Using Acetone, wipe the backside of the tile around the perimeter and along the internal cross pattern, to remove any dirt or dust particles from the area to receive the adhesive.
- H. Apply Tactile Bond & Seal adhesive to the backside of the tile, following the perimeter and internal cross pattern established by the tile manufacturer. Sufficient adhesive must be placed on the prescribed areas to have full coverage across the 2" width of the adhesive locator and should be applied to within 1/4" continuously around the perimeter edge of the tile. The entire tube of adhesive should be applied to the back of each tile, sizes 24" x 36" and greater.
- I. Set the tile true and square to the curb ramp area as detailed in the design drawings.
- J. Working from the center of the tile outwards, proceed to drill and install all fasteners in the tile's molded recesses.
- K. Standing with both feet applying pressure around the molded recess provided in the tile, drill a hole true and straight to a depth of 3½" using a 1/4" drill bit. Drill through the tile without hammer option until the tile has been successfully penetrated, then with hammer option to drill into the concrete. Maintaining foot pressure on both sides of the hole while drilling prevents concrete dust from accumulating between the tile and concrete which can affect the tile being installed flush and may compromise installation integrity.
- L. Immediately after drilling each hole, before moving on to the next, and while still applying foot pressure, mechanically fasten tiles to the concrete substrate using a leather bound or hard plastic mallet to set the fasteners. Ensure the fastener has been placed to full depth in the dome, straight, and flush to the top of dome. Drive the pin of the fastener with the mallet, taking care to avoid any inadvertent blows to the truncated dome or tile surface.
- M. Following the installation of the fasteners, the concrete dust should be vacuumed, brushed or blown away from the tile's surface and adjacent concrete. Using Acetone on a rag, wipe the concrete around the tile's perimeter to ensure a clean, dry surface to receive perimeter sealant.
- N. Tactile Bond & Seal perimeter caulking sealant should be applied following the sealant manufacturer's recommendations. Tape all perimeter edges of the tile back 1/16" from the tile's perimeter edge and tape the adjacent concrete back 1/2" from the tile's perimeter edge. Apply sealant around tile perimeter using care to work sealant into any void between the tile and concrete interface. Tool the perimeter caulking with a plastic applicator or spatula to create a straight edge in a cove profile between the tile and adjacent concrete. Remove tape immediately after tooling perimeter caulking sealant.
- O. Do not allow foot traffic on installed tiles until the perimeter caulking sealant has cured sufficiently to avoid tracking. Adhesive or caulking on the surface of the Armor-Tile can be removed with Acetone.
- P. If installing adjacent tiles, note the orientation of each tile. Careful attention will reveal that one of the long edges of the tile is different than the other in regard to the tiny dotted texture. You may also note a larger perimeter margin before the tiny dotted texture pattern begins. Consistent orientation of each Armor-Tile is required in order that the truncated domes on adjacent tiles line up with each other.
- Q. In order to maintain proper spacing between truncated domes on adjacent tiles, the tapered edge should be trimmed off using a continuous rim diamond blade in a circular saw or mini-grinder. The use of a straightedge to guide the cut is required. All cuts should be made prior to installation of the tiles. If installing adjacent tiles, care should be taken to leave a 1/8 inch gap between each tile to allow for expansion and contraction.
- R. If tiles are custom cut to size, if pre-molded recesses (to receive fasteners) are removed by the cut, or to maintain a tight installation to the substrate then any truncated dome can be center-drilled with a 1/4 inch through hole, and countersunk with a suitable bit, to receive mechanical fasteners. Care should be taken to not countersink too widely or deeply. Fasteners should be flush with the top of the truncated dome when countersunk properly.

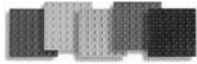

Installation Instructions

Surface Applied Inline Dome Tile

View installation slide show, drawings and specifications on our website – www.armor-tile.com
Call 1-800-682-2525 if you have any questions

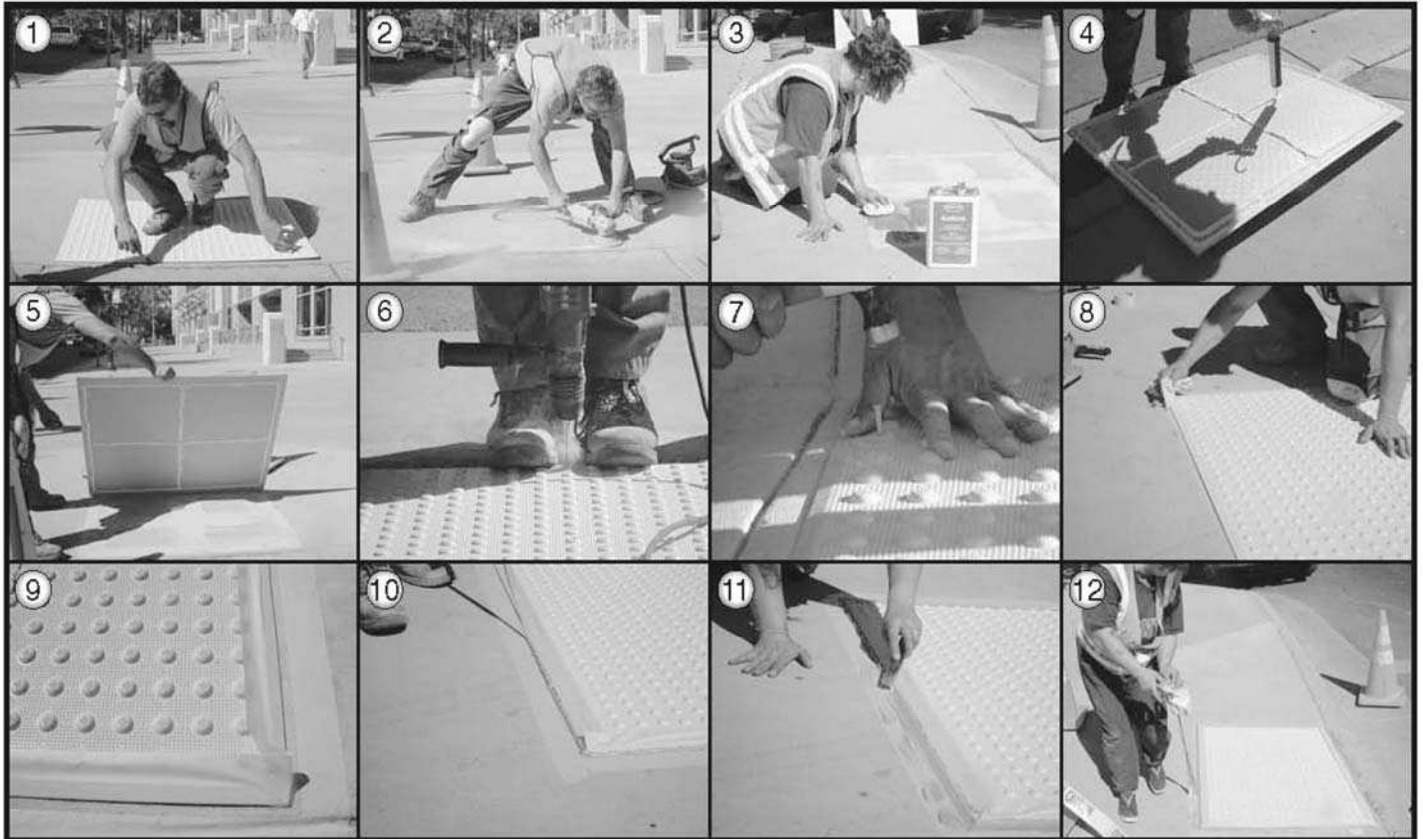

1. Place the tile on the designated location and trace the perimeter with a thin permanent marker.
2. Set the tile aside and using a 4" diamond cup grinder, scour the concrete within the marked location and on a cross pattern corresponding with the boss on the backside of the tile to remove any dirt or foreign material. (Not recommended for asphalt surfaces).
3. Clear away the dust with a leaf blower then clean the back of the tile and the concrete with rag soaked in Acetone.
4. Apply the entire tube of adhesive (Tactile Bond & Seal) to the back of the tile following the perimeter and cross pattern. The first bead should be applied thin, $\frac{3}{4}$ " from the perimeter edge and a second bead applied 1" inside of the first. Extra adhesive can be applied to each corner should extra adhesive (Tactile Bond & Seal) be available.
5. Set the tile true and square to the curb ramp and press down firmly.
6. Keeping weight on either side of the pilot hole, drill down 3 $\frac{1}{2}$ " into the concrete using a hammer drill and the recommend diameter drill bit. Drill through the tile without the hammer option until the tile has been penetrated, then with the hammer option drill into the concrete.
7. While still applying pressure, remove the dust and any adhesive that surfaces and carefully set the mechanical fastener with a hammer. To prevent damage to the tile, a plastic dead blow or leather hammer is recommended. Repeat 6 & 7.
8. Clean the perimeter of the tile and the immediate surrounding concrete with Acetone making sure to remove any adhesive that has escaped from beneath the tile.
9. Mask the edge of the tile and the concrete leaving a $\frac{1}{2}$ " gap back from the tile's perimeter edge.
10. Apply the perimeter sealant (Tactile Bond & Seal).
11. Using a plastic applicator or spatula smooth out the sealant (Tactile Bond & Seal) in a cove profile between the tile and adjacent concrete.
12. Carefully remove the masking tape immediately after tooling the perimeter sealant.



Armor-Tile

Tactile Systems

Instrucciones de instalación

Para instalar en concreto curado

Vea la presentación con fotos, diagramas y especificaciones en nuestra página web - www.armor-tile.com
Si tiene cualquier pregunta, llame al 1-800-682-2525

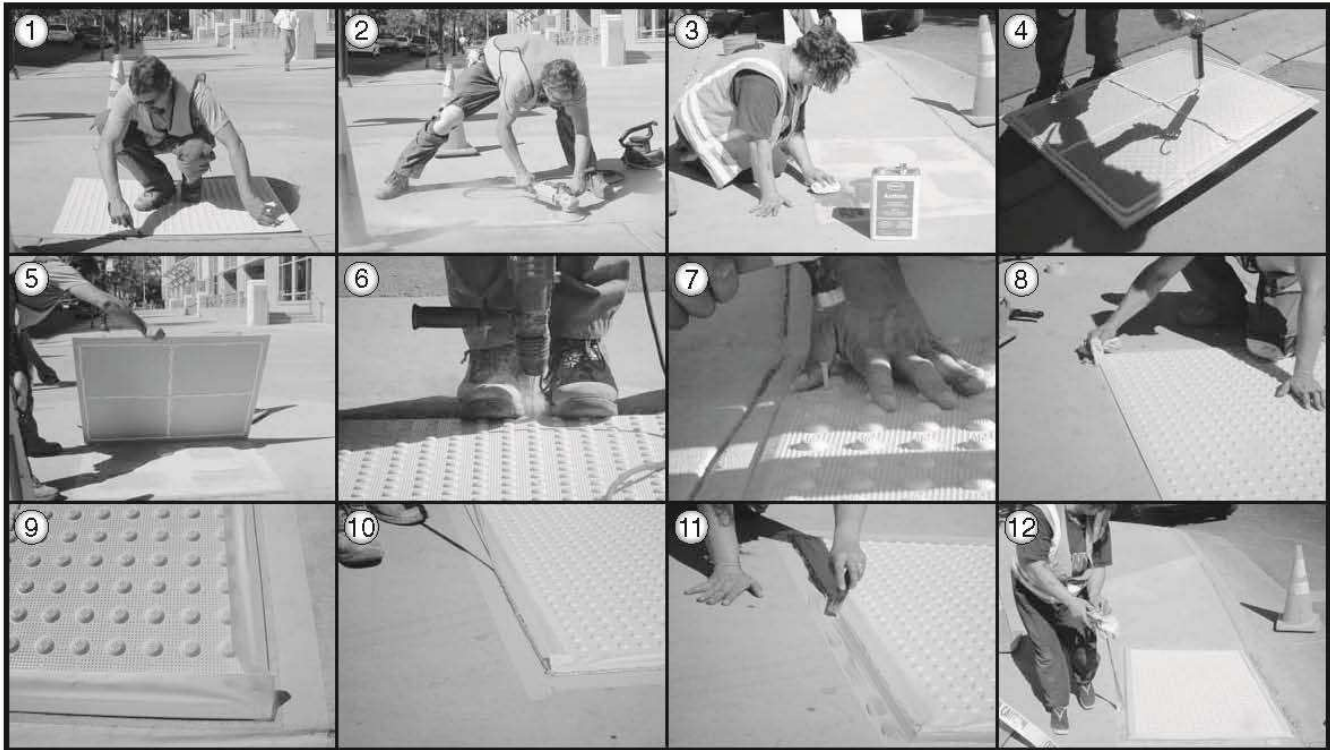

1. Coloque la baldosa en el lugar designado y trace su perímetro en el piso con un marcador permanente de punta fina.
2. Ponga la baldosa a un lado y usando una esmeriladora con disco cortador diamantado cónico de 10cm (4") raspe la superficie del piso a lo largo del perímetro y en patrón cruzado similar al patrón marcado en el revés de la baldosa. (No se recomienda para superficies de asfalto.)
3. Elimine el polvo creado en el piso con un soplador de hojas y limpie el concreto y el revés de la baldosa con un trapo remojado en acetona.
4. Aplique el tubo completo de pegamento (Tactile Bond & Seal) en el revés de la baldosa siguiendo el perímetro y el patrón cruzado. Comience con una línea fina a 19mm (3/4") del borde. Luego aplique una segunda línea de pegamento paralela a la anterior y a unos de 2,5cm (1") hacia adentro. Si sobra pegamento (Tactile Bond & Seal) aplíquelo en las esquinas.
5. Coloque la baldosa sobre el piso, alinéandola a escuadra con el borde de la acera o cara del bordillo y presiónela firmemente.
6. Manteniendo peso a ambos lados de uno de los agujeros de guía de la baldosa, perforo un agujero de 9cm (3 1/2") en el concreto con un taladro percutor con un barreno (broca) del diámetro recomendado. Desactive la acción percutora del taladro hasta atravesar la baldosa completamente, luego actívela para taladrar en el concreto.
7. Mientras sigue aplicando presión a la baldosa, elimine el polvo de concreto y los residuos de pegamento que hubiesen escapado e instale cuidadosamente el electro de anclaje mecánico con un martillo. Para evitar dañar la baldosa se recomienda aplicar golpes secos con un mazo o martillo con cabeza de plástico o cuero. Repita los pasos 6 y 7 para los demás agujeros de guía de la baldosa.
8. Limpie el perímetro de la baldosa y el concreto directamente a su alrededor con acetona, cerciorándose de remover todo el pegamento que hubiese escapado por debajo de la baldosa.
9. Forre el borde de la baldosa y el concreto alrededor con cinta para enmascarar, dejando una separación de 13mm (1/2") entre el borde de la baldosa y la cinta aplicada al concreto.
10. Aplique sellador (Tactile Bond & Seal) alrededor del perímetro.
11. Usando un aplicador plástico o una espátula, alise el sellador (Tactile Bond & Seal) con un perfil cóncavo entre la baldosa y el concreto adyacente.
12. Retire cuidadosamente la cinta de enmascarar inmediatamente después de alisar con una herramienta el sellador a lo largo del perímetro de la baldosa.



ENGINEERED PLASTICS INC.

300 International Dr., Suite 100, Williamsville, NY 14221 Tel: 1-800-682-2525 Fax: 1-800-769-4463
www.armor-tile.com

r1015

Armor-Tile

Tactile Systems

CLEANING AND MAINTENANCE MANUAL

The Armor-Tile Detectable Tile is unique in its visual and tactile properties and requires a slight variation in cleaning procedures. Due to the undulation and texture of the tile surface, it is necessary to reach the grime that rests on the low parts of the tile. Standard wet mopping will not be completely effective in cleaning these textured surfaces. A major benefit of the vitrified polymer composite tile is that the composition is virtually non-porous, and prevents liquids, dust and grime seeping into the body of the tile. The unique, non-porous nature of the tile therefore lends itself to regular and frequent cleaning in order to maintain and enhance the visual contrast that the bright yellow tile provides. Visual contrast is an essential safety feature of the tactile tiles, and this contrast must be rigorously maintained with regular cleaning in order to provide the contrast that the visually impaired rely on for their safety. The use of general purpose commercial floor cleaners or machine bristle scrubbing will not harm Armor-Tile. However, as these cleaning practices may weaken or dissolve the adjacent floor finish, careful attention must be paid to the selection and application of the cleaning solution. It is advisable to check with the manufacturer of the cleaning solution in order to be certain that the product intended to be used will not harm the Armor-Tile, grout, or the adjacent floor finish in any way.

Regular Maintenance

Many neutral general purpose cleaners are effective for the regular maintenance and cleaning of Armor-Tile. It is important that the cleaner to be used has a non-oil, non-animal fat, non-soap base. Cleaners with these bases may cause problems due to oil-residues which tend to trap dirt in the cleaning process.

Please remember to treat any cleaning product you wish to use on a small, out of the way test area of the tactile surface and adjacent floor area before applying it to the entire Armor-Tile surface. This will ensure that it performs as desired, not only on the Armor-Tile surface but also on the adjacent floor finish, thus avoiding unexpected problems.

Avoid Surface Coatings

Armor-Tile does not require the use of sealants or waxes. Adding surface coatings increases the number of unnecessary steps in maintenance procedures without improving either the appearance of the tile, or the resistance to dirt build-up. In fact, using a surface coating turns a low maintenance vitrified polymer composite finish into a high maintenance tile.

In addition, surface coatings will actually diminish the unique performance characteristics that make Armor-Tile exceptional among tactile tiles. Such surface coatings create a thin barrier that may modify the skid resistance and visibility properties, thereby reducing an important safety feature of the flooring.



ENGINEERED PLASTICS INC.

300 International Dr., Suite 100, Williamsville, NY 14221 Tel: 1-800-682-2525 Fax: 1-800-769-4463

www.armor-tile.com

Armor-Tile

Tactile Systems

October 8, 2015

Certificate of Compliance

Engineered Plastics Inc. certifies that the Armor-Tile and the specified installation materials are in compliance with following:

Americans with Disabilities Act (ADA) (Title III Regulations, 28 CFR Part 36 ADA STANDARDS FOR ACCESSIBLE DESIGN, Appendix A, Section 4.29.2 DETECTABLE WARNINGS ON WALKING SURFACES).

California Code of Regulations (CCR): Provide only approved DSAAC detectable warning products as provided in the California Code of Regulations (CCR) Title 24, Chapter 2, Section 202 definition of "Detectable Warning". Section 11B-247 and 11B-705 "Detectable Warnings and Detectable Directional Texture"

Please visit our web site www.armor-tile.com or call us directly for additional information regarding our products and services.

Sincerely,

John A Heffner
Vice President
Engineered Plastics Inc.

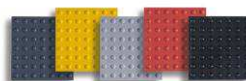

ENGINEERED PLASTICS INC.

300 International Dr., Suite 100, Williamsville, NY 14221 Tel: 1-800-682-2525 Fax: 1-800-769-4463

www.armor-tile.com

Armor-Tile

Tactile Systems

MATERIAL WARRANTY*

Contract No./Date:
Project Description:
Contractor/Sub:
Owner:
Product Installed:

***issued on a per project basis**

Engineered Plastics Inc. warrants to the Owner that Armor-Tile Detectable Warning Tiles manufactured by Engineered Plastics Inc. are free from defects in workmanship and material including deformation, breakage and delamination for a period of Five (05) years from the date of acceptance of the project.

EXCLUSIVE REMEDIES. Engineered Plastics Inc., at its cost, will repair or replace defective material promptly reported to Engineered Plastics Inc. during the warranty period. This warranty includes labor costs and cost of removal of the product. Repair or replacement will be done on site.

WARRANTY LIMITATIONS. Engineered Plastics Inc. warranty of Armor-Tile products does not apply to conditions resulting from improper installation, improper use, external causes, intentional misuse or abuse, neglected or improper annual maintenance, vandalism, modifications to the Armor-Tile products or installation procedures with the exception of the Owner's right to immediately eliminate an unsafe condition.

DISCLAIMER OF WARRANTIES The above warranties are the Owner's exclusive warranties. No other warranty, express or implied, shall apply. Engineered Plastics Inc. specifically makes no warranty of merchantability and/or fitness for a particular purpose.

IN NO EVENT WILL ENGINEERED PLASTICS INC. BE LIABLE FOR ANY DAMAGES, LOST PROFIT, DIRECT, CONSEQUENTIAL OR ECONOMIC DAMAGES.

MATERIAL SUPPLIER:

Engineered Plastics Inc.

Authorized Signature

Name: _____
Title: _____
Date: _____



ENGINEERED PLASTICS INC.

300 International Dr., Suite 100, Williamsville, NY 14221 Tel: 1-800-682-2525 Fax: 1-800-769-4463
www.armor-tile.com