

SIMPLECURVE® AND KAM

Knurled Angle Molding



SUSTAIN™
High Performance
Sustainable
Ceiling Systems

KEY SELECTION ATTRIBUTES



- Hemmed edges are easier to handle than standard "shiny ninety" framing angle
- Easier to install – prepunched holes on the top edge and ScrewStop™ reverse hem catch screws, preventing slip off
- Quick to open and chop saw to length
- Packaged 10 pcs/bundle
- Sourced and manufactured in the USA

KAM

- Runs straight and true – 25 gauge KAM (meets ANSI C645 for framing)
- Available in popular 1-1/4", 1-1/2", and 2" sizes in the right gauges for your project

SimpleCurve®

- Available in 1-1/2" and 2" sizes in the right gauges for your project
- Bend to create curves as tight as 32" radius



▲ SimpleCurve® Knurled Angle Molding

VISUAL SELECTION

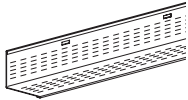
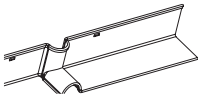
	Item No.	Height	Length	Metal Thickness	Packaging Pcs.	Lin. Ft.
Knurled Angle Molding 	KAM10	1-1/4"	120"	0.018"	10	100
	KAM12	1-1/4"	144"	0.018"	10	120
	KAM12G90	1-1/4"	144"	0.018"	10	120
	KAM12HRC	1-1/4"	144"	0.018"	10	120
	KAM1510	1-1/2"	120"	0.018"	10	100
	KAM1512	1-1/2"	144"	0.018"	10	120
	KAM151020E	1-1/2"	120"	0.028"	10	100
	KAM151220E	1-1/2"	144"	0.028"	10	120
	KAM151020	1-1/2"	120"	0.033"	10	100
	KAM151020G90	1-1/2"	120"	0.033"	10	100
	KAM1525G90	1-1/2"	120"	0.128"	10	100
	KAM1520G90	1-1/2"	120"	0.128"	10	100
	KAM21025	2"	144"	0.018"	10	100
	KAM21020EQ	2"	120"	0.028"	10	100
KAM21020	2"	120"	0.033"	10	100	
SimpleCurve® KAM 	SC151220EQ (37" Radius)	1-1/2"	148"	0.028"	10	124
	SC151225 (32" Radius)	1-1/2"	148"	0.018"	10	124
	SC21220EQ (55" Radius)	2"	148"	0.028"	10	124
	SC21225 (40" Radius)	2"	148"	0.018"	10	124

NOTE: .018" metal thickness meets ASTM C645 for framing



SIMPLECURVE® AND KAM

Knurled Angle Molding



LEED® WELL | LBC

UP TO 61% RECYCLED CONTENT

- energy management
- construction waste mgmt
- regional materials
- design for flexibility
- EPD
- recyclable/producer resp.
- biobased materials
- recycled content
- sourcing of raw materials
- material ingredient reporting
- low emitting materials
- lighting quality
- acoustics

Calculate sustainability with Green Genie™ armstrongceilings.com/greengenie

LOCATION DEPENDENT

Well Building Standard™ (WELL) Living Building Challenge® (LBC)

Knurled Angle Molding

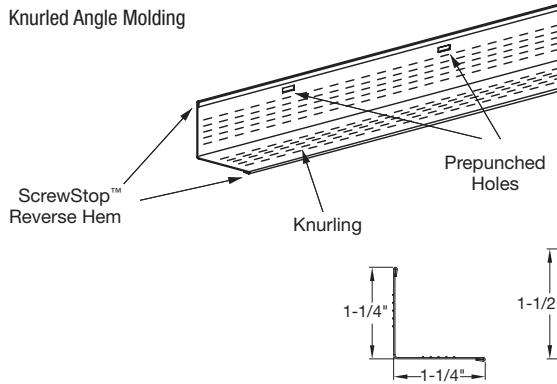

SimpleCurve® KAM

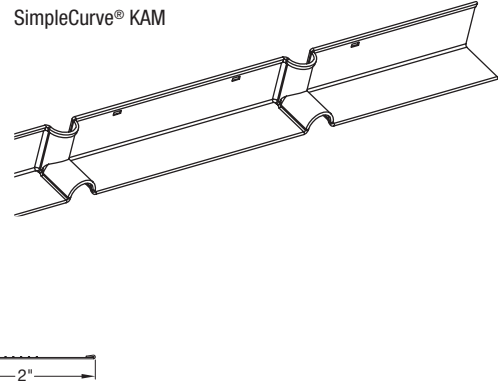

ACCESSORIES

Drywall Attachment Clip facilitates transition from drywall to acoustical ceiling; locks under bulb of grid section to prevent upward movement and provides secure attachment surface on one side of exposed grid.

DWACS – 100 pcs
FZDWACS – 50 pcs

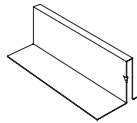

30-, 45-, 60-, and 90-degree Drywall Angle Clips are used to create positive and secure angles for drywall and ceiling installations on either main beams or cross tees.

DW30C – 250 pcs
FZDW30C – 50 pcs
DW45C – 250 pcs
FZDW45C – 50 pcs

DW60C – 250 pcs
FZDW60C – 50 pcs
DW90C – 250 pcs
FZDW90C – 50 pcs

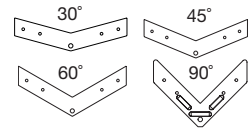

Partition Top Trim is used to finish the top of a drywall partition for a continuous drywall/acoustical ceiling interface.

TT10 – 30 pcs

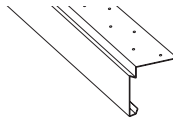

Transition Clip for 5/8" Drywall (DW58LT and FZDW58LT) or 1/2" Drywall (DW50LT or FZDW50LT) with Locking Tabs; facilitates transition from drywall to acoustical ceiling; one-sided hold down clip; eliminates need for drywall bead. Locking tabs provide secure location for DGS tees.

DW58LT – 125 pcs
FZDW58LT – 50 pcs

DW50LT – 125 pcs
FZDW50LT – 50 pcs

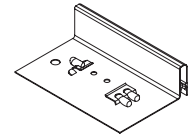

DW58LT and DW50LT

Main Beam Adapter Clip attaches to web of grid section; provides larger surface for screw attachment; used as a hold down clip for thin material (metal or plastic lay-in panels); fastens drywall track to underside of exposed grid with lay-in panels, leaving grid face free of screw holes

MBAC – 70 pcs

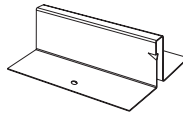

Adjustable Grid Spacer Clip is used to space two parallel main beams for light fixtures, air diffusers, etc.; allows for 1/4" adjustments with three different clips.

GSC9 – 100 pcs
FZGSC9 – 50 pcs
GSC12 – 100 pcs
FZGSC12 – 50 pcs

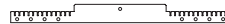

GSC16 – 100 pcs
FZGSC9 – 50 pcs

Cross Tee Adapter Clip is used to attach field-cut cross tees to main beams.

XTAC – 100 pcs
FZXTAC – 50 pcs

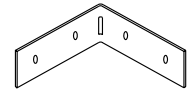

Double Drywall Clip to hang suspension system below existing 1-1/2" grid face, transferring weight directly to hanger wire; may be used to preserve the fire rating of an existing ceiling and to support heavy accessories; allows for double layer of 5/8" gypsum board.

DDC – 250 pcs
FZDDC – 50 pcs



Direct Load Ceiling Clip to hang suspension system below existing 15/16" grid face, transferring weight directly to hanger wire; may be used to preserve the fire rating of an existing ceiling and to support heavy accessories.

DLCC – 250 pcs
FZDLCC – 50 pcs

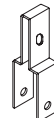

Drywall Clip allows for a "second" ceiling to be installed below a drywall ceiling; attach through installed drywall to supporting structure.

DWC – 250 pcs
FZDWC – 50 pcs

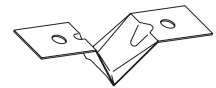

Sound Isolation Clip provides up to eight points of Impact Insulation Class improvement in drywall ceiling installations using Armstrong drywall grid main beam HD8906IIC to help ensure your project meets International Building Code requirements.

IIC – 36 pcs/box

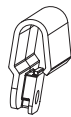

DRYWALL INSTALLATION SYSTEMS – Standard