

PRELUDE® XL MAX®

Exposed Tee System



SUSTAIN™
High Performance
Sustainable
Ceiling Systems



▲ Prelude® XL Max® with Ultima® (item 1927) ceiling panels

This suspension system is designed to offer maximum air flow management, load-carrying capacity, and adaptability in data center applications.

KEY SELECTION ATTRIBUTES

Prelude® XL Max® 15/16" Suspension System

- 24" x 24" and 24" x 48" suspension system supports point loads up to 300 lbs. using 3/8" threaded rod and integrated hanging clips to provide:
 - Flexible and reconfigurable overhead cable tray and electrical distribution to meet client needs without a separate strut channel system
 - Eliminates unsightly threaded rod penetrations through the ceiling plane for improved access and aesthetics
 - Reduced ceiling penetrations help minimize unwanted air infiltration
- Prelude® XL Max® is part of the Sustain™ portfolio and meets the most stringent industry sustainability compliance standards today
- CleanAssure™ family of products – includes disinfectable panels, suspension systems, and trim (Cleaning and CDC approved disinfecting options available on armstrongceilings.com/cleaning)
- Suspension system meets ASTM C635, ASTM C636, ASTM E580, ICC-ES AC156 with Seismic D, E, F available
- 30-Year Limited System Warranty

- Standard 24" x 24" and 24" x 48" grid layouts allow for use of standard size lighting and specially sized Prelude® XL Max® ceiling tile options
- For custom layout information and technical guidelines, contact TechLine customer support at 877 276-7876.

TYPICAL APPLICATIONS

- Data Centers
- Laboratories
- Hospitals
- Industrial Warehouses/
Distribution Centers
- Retail/Convenience Stores

COLORS

Due to printing limitations, shade may vary from actual product.

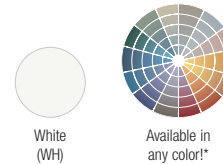

White (WH)

Available in any color!*

*Colors that are pre-qualified to meet Sustain™ portfolio requirements are available upon request. Other made-to-order colors must be evaluated if sustainability criteria is required. Lead time will increase.

White is standard color for main beams and cross tees. All clips are unfinished.
Custom colors and finishes are available for main beams, cross tees, load connector clips, and ceiling panels
For custom layout information and technical guidelines, contact TechLine customer support at 1 877 276 7876

VISUAL SELECTION

	Item No.	Description	Dimensions Nominal (Inches)	MAX LOADING* LBS./LIN. FT.	
				2 Ft.	4 Ft.
Prelude® XL Max® 15/16"	730145	12' HD Main Beam	144 x 15/16 x 2-7/16"	135.5	40.17
	XL7345	4' Cross Tee	48 x 15/16 x 2-7/16"	N/A	40.17
	XL7325	2' Cross Tee	24 x 15/16 x 2-7/16"	93.82	N/A
Molding 7/8"	SWA9878HRC	12' Structural Wall Angle	144 x 7/8 x 7/8"	N/A	N/A

*Simple Span

PERFORMANCE

Fire Guard™	Seismic Category	CleanAssure™ Disinfectable Grid		
		Fog	Spray	Wipe
DEF	DEF			

PACKAGING

Pieces/ Carton	LFT/ Carton
10	120
30	120
30	60
12	144

Dots represent high level of performance.



PRELUDE® XL MAX®

Exposed Tee System



Declare.

LEED WELL™ LBC

50% RECYCLED CONTENT

energy management, construction waste mgmt, regional materials, design for flexibility, EPD, recyclable/extended producer resp., biobased materials, recycled content, sourcing of raw materials, material ingredient reporting, low emitting materials, lighting quality, acoustics

Calculate sustainability with Green Genie™ armstrongceilings.com/greengenie

LOCATION DEPENDENT

Well Building Standard™ (WELL) Living Building Challenge® (LBC)

VISUAL SELECTION

NOTE: These panels are specially sized and engineered for Prelude® XL Max® and must be used with the system. These panels do not fit in other suspension systems.

	Item No.	Dimensions (Inches)
Fine Fissured™ for Prelude® XL Max®	1778	23-13/16 x 23-13/16 x 5/8"
Square Lay-in	1779	23-13/16 x 47-13/16 x 5/8"
	1747ABL (Black)	23-13/16 x 23-13/16 x 5/8"
	1748ABL (Black)	23-13/16 x 47-13/16 x 5/8"
Canyon® for Prelude® XL Max®	1488	23-13/16 x 23-13/16 x 5/8"
Square Lay-in	1489	23-13/16 x 47-13/16 x 5/8"
Ultima® for Prelude® XL Max®	1927	23-13/16 x 23-13/16 x 3/4"
Square Lay-in	1928	23-13/16 x 47-13/16 x 3/4"
Clean Room™ FL for Prelude® XL Max®	1815	23-13/16 x 23-13/16 x 3/4"
Square Lay-in	1816	23-13/16 x 47-13/16 x 3/4"

PERFORMANCE SELECTION

Dots represent highest level of performance.

Sound Absorption	Sound Blocking	Total Acoustics ¹	Articulation Class	Fire Performance	Light Reflect	Bio-Block	Humi-Guard+	Certified Low VOC Emissions	Durability	Recycled Content	Recycle Program	30-Yr Warranty
NRC	CAC	NRC CAC	AC	Class	Light	Anti-Mold/Mildew	Sag Resistant	Low VOC	Std	Std	Recycle	Warranty
0.55	35	N/A	N/A	Class A	0.82	•	•	•	•	•	•	•
0.55	35	N/A	N/A	Class A	0.82	•	Std	•	•	•	•	1-Yr
0.55	35	N/A	N/A	Class A	N/A	•	•	•	•	•	•	•
0.55	35	N/A	N/A	Class A	N/A	•	Std	•	•	•	•	1-Yr
0.65	35	GOOD	N/A	Class A	0.80	•	•	•	•	Std	•	•
0.65	35	GOOD	N/A	Class A	0.80	•	•	•	•	Std	•	•
0.75	35	BETTER	170	Class A	0.88	•	•	•	•	•	•	•
0.75	35	BETTER	170	Class A	0.88	•	•	•	•	•	•	•
0.55	35	N/A	N/A	Class A	0.79	•	•	•	•	•	-	•
0.55	35	N/A	N/A	Class A	0.79	•	•	•	•	•	-	•

¹ Total Acoustics® ceiling panels have an ideal combination of noise reduction and sound blocking performance in one product. **GOOD** (NRC 0.60-0.65; CAC 35+) **BETTER** (NRC 0.70-0.75; CAC 35+) **BEST** (NRC 0.80+; CAC 35+)

ACCESSORIES

PMHC – Prelude® Max Hanging Clip – Used to carry the ceiling system with 3/8" threaded rod from structure. (Machine screws, Heavy Hex Nut, and Locknut included)

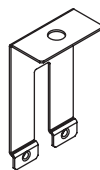

PMHC – 150 pcs
FZPMHC – 50 pcs

PMLC – Prelude® XL Max® Load Connector – Used to support busbar, cable trays, and other components with 3/8" threaded rod from the suspension system face. (Heavy Hex Nut & Locknut included)

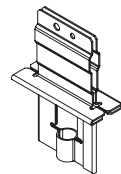

PMLC – 100 pcs
FZPMLC – 50 pcs

IJC – Intersection Joint Clip – Used to connect all cross tees together for rigid connection. (Machine screws included)

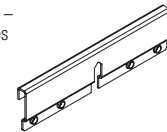

IJC – 250 pcs
FZIJC – 50 pcs

XTAC – Cross Tee Adapter Clip – Securely attaches cross tees or main beams to the structural wall molding around the perimeter of the ceiling installation.

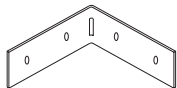

XTAC – 100 pcs
FZXTAC – 50 pcs

TLMBS – Top Lock Main Beam Splice Clip – Locks two main beams together for a secure connection.

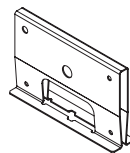

TLMBS – 50 pcs

PMHDC – Prelude® XL Max® Hold-Down Clip – Attaches to the top bulb of the Prelude® XL Max® suspension system to hold ceiling panels in place; helps to prevent ceiling panel movement.

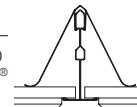

PMHDC – 100 pcs
FZPMHDC – 50 pcs

LSB – Lateral Support Bar (Seismic Zone DEF Only)

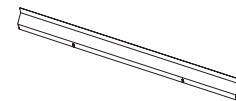

LSB12HRC – 10 pcs/120 LF
LSB10HRC – 10 pcs/100 LF
LSB8HRC – 10 pcs/80 LF

PRELUDE® XL MAX® Exposed Tee System



Declare.

LEED® WELL | LBC

50% RECYCLED CONTENT

ALUMINIUM

- energy management
- construction waste mgmt
- regional materials
- design for flexibility
- EPD
- recyclable/producer resp.
- biobased materials
- recycled content
- sourcing of raw materials
- material ingredient reporting
- low emitting materials
- lighting quality
- acoustics

Calculate sustainability with Green Genie™
armstrongceilings.com/greengenie

LOCATION DEPENDENT

Well Building Standard™ (WELL)
Living Building Challenge® (LBC)

PRELUDE® XL MAX® INSTALLATION OVERVIEW

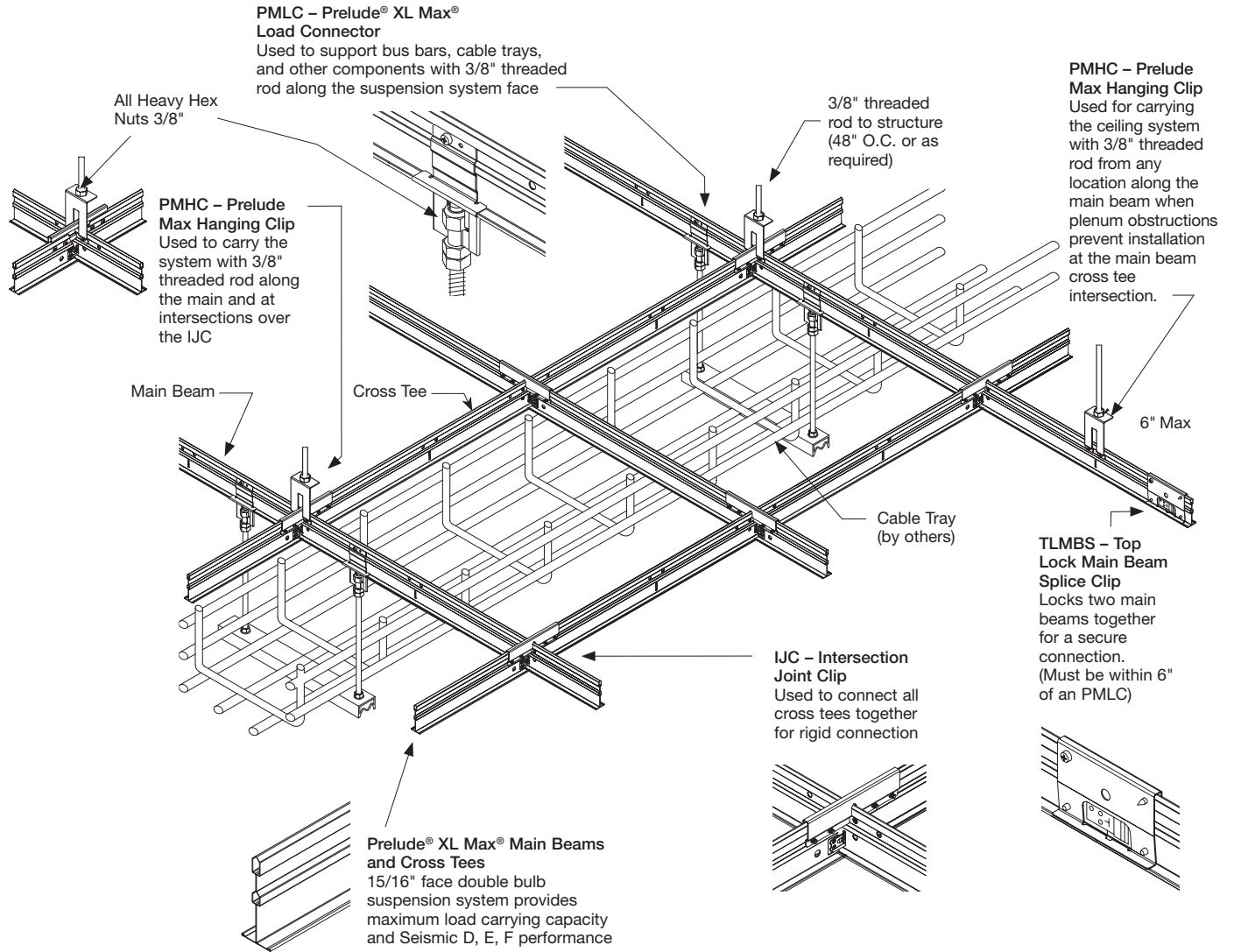

SUSPENSION SYSTEMS – DATA CENTERS

PRELUDE® XL MAX®

Exposed Tee System



Declare

LEED WELL LBC

50% RECYCLED CONTENT

- energy management
- construction waste mgmt
- regional materials
- design for flexibility
- EPD
- recyclable/extended producer resp.
- biobased materials
- recycled content
- sourcing of raw materials
- material ingredient reporting
- low emitting materials
- lighting quality
- acoustics

Calculate sustainability with Green Genie™
armstrongceilings.com/greengenie

LOCATION DEPENDENT

Well Building Standard™ (WELL)
Living Building Challenge® (LBC)

LIGHTING INTEGRATION

Lighting solutions are available through partner companies.

JLC • tech

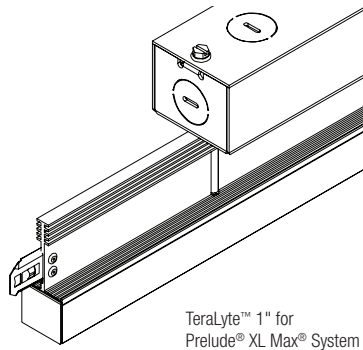

TeraLyte™ 1" for Prelude® XL Max® System

DETAILS

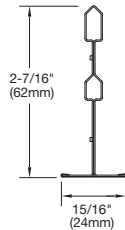
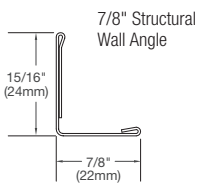

Prelude® XL Max®
Main Beam
& Cross Tee

GRID PHYSICAL DATA

Material
Hot dipped galvanized steel

Surface Finish
Baked polyester paint or powder coated

Manufactured and tested in accordance with ASTM C635

Face Dimension
15/16"

Profile
Exposed tee

Cross Tee/Main Beam Interface
Override

End Detail
Main Beam: Staked-on clip
Cross Tee: Staked-on clip

Duty Classification
Heavy-duty

CEILING PANELS PHYSICAL DATA

Ceiling Panels ASTM E1264 Classification
Type XII, Form 2, Pattern E
Fire Class A

Pieces/Carton;
Square Feet/Carton
1927 – 12 pcs/ctn; 48 SF/ctn
1928 – 6 pcs/ctn; 48 SF/ctn
3398 – 32 pcs/ctn; 128 SF/ctn
3399 – 16 pcs/ctn; 128 SF/ctn
1488 – 16 pcs/ctn; 64 SF/ctn
1489 – 8 pcs/ctn; 64 SF/ctn

1747ABL – 16 pcs/ctn; 64 SF/ctn
1748ABL – 12 pcs/ctn; 96 SF/ctn
1778 – 14 pcs/ctn; 56 SF/ctn
1779 – 8 pcs/ctn; 64 SF/ctn
1815 – 12 pcs/ctn; 48 SF/ctn
1816 – 8 pcs/ctn; 64 SF/ctn

