

Step 1.1 Check to make sure wood nailer and waterproofing membrane are installed correctly.

Note: Wood Nailer should be installed flush with the face of the Wall. Waterproofing Membrane should extend below the nailer at the Face.

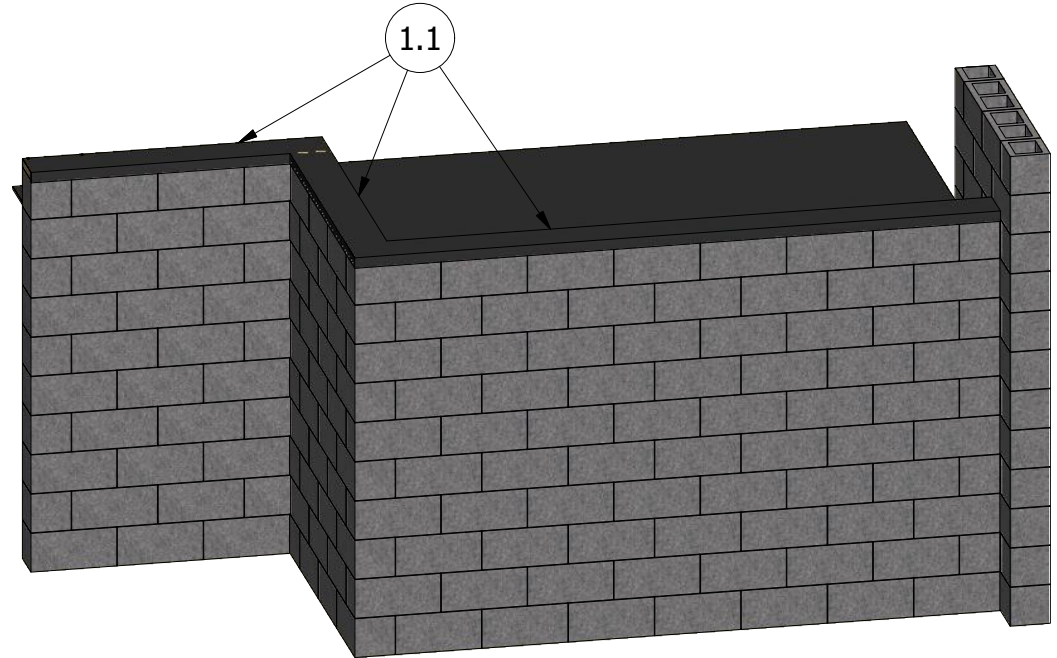
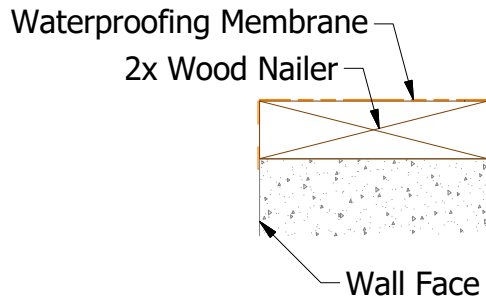

Step 1

Step 2.1 Install Intermediate Cleats and Splice Cleats on top of Wall using pre-punched holes.

Step 2.2 Intermediate Cleats and Splice Cleats should be installed 48" O.C. for 4"-12" wide copings, and 36" O.C. for 12"-32" wide copings. (4"-12" coping shown)

Step 2.3 Corner Supports are Installed Only on the Outside Corners for Mitered Corner Cap.

Note: Splice Cleats should be installed at Coping Cover Transitions (end walls and inside/outside corners). Intermediate Cleats should be installed with straight lengths of Coping Covers.

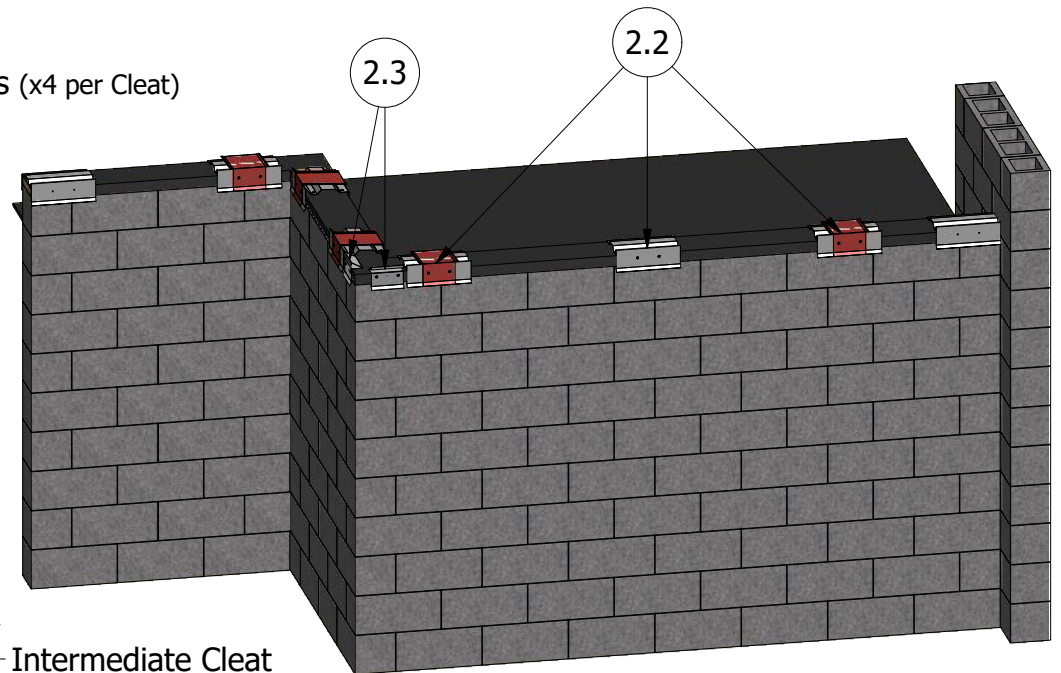
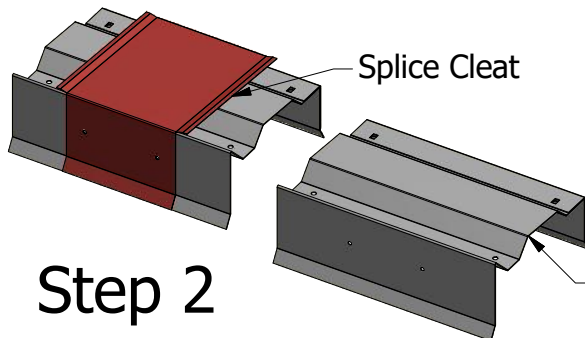
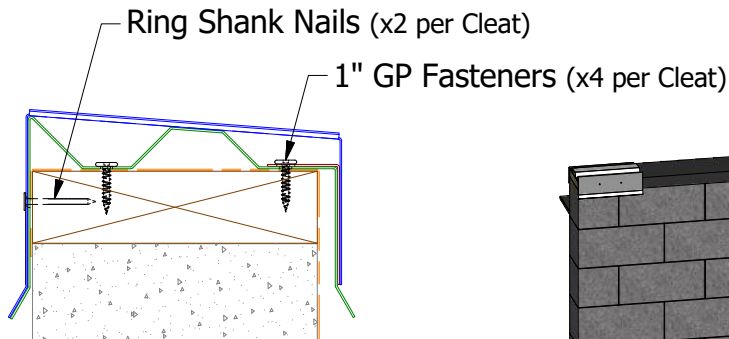

Step 2

Step 3.1 Install Inside and Outside Mitered Corners.

Step 3.2 Mitered Corners should be installed on Splice Cleats.

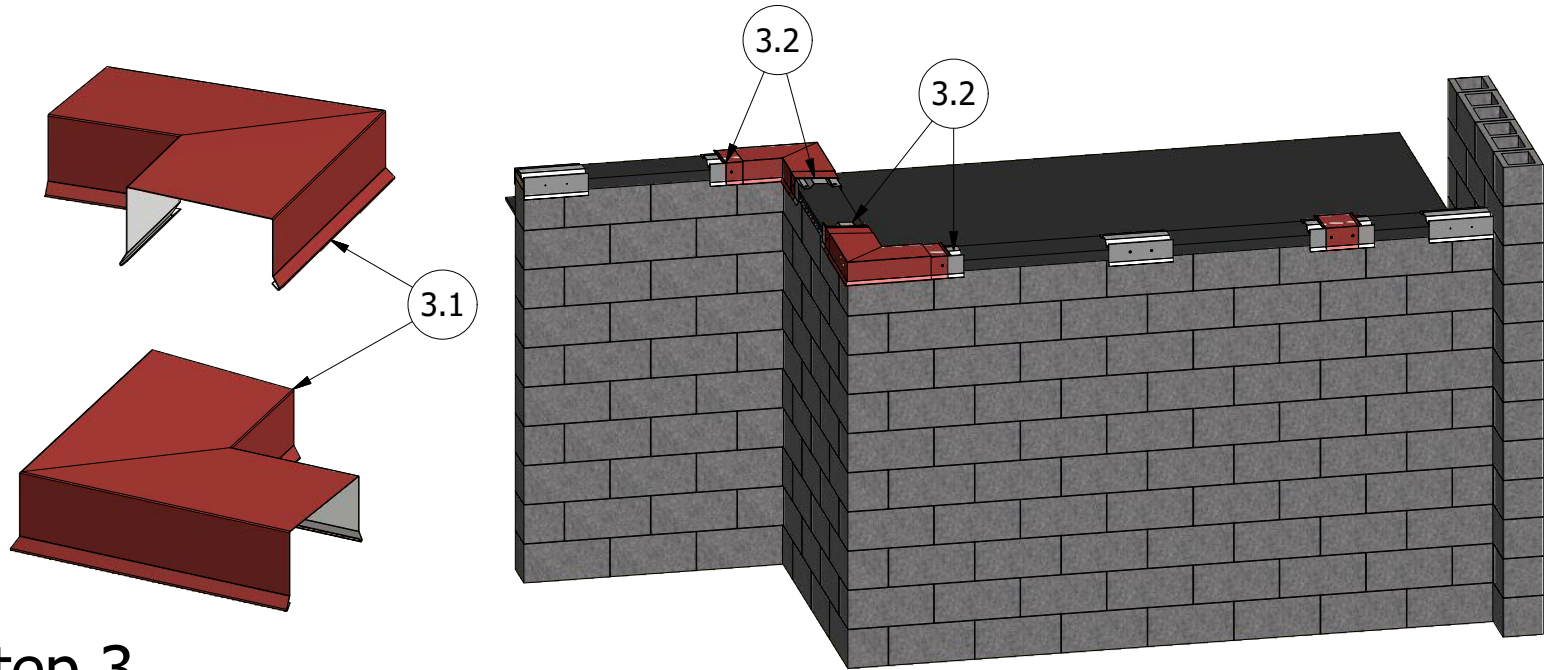

Step 3

Step 4.1 When Ending Coping into another wall use Factory installed End Term Section.

Step 4.2 When Ending Coping at end use Factory Installed End Closure Section.

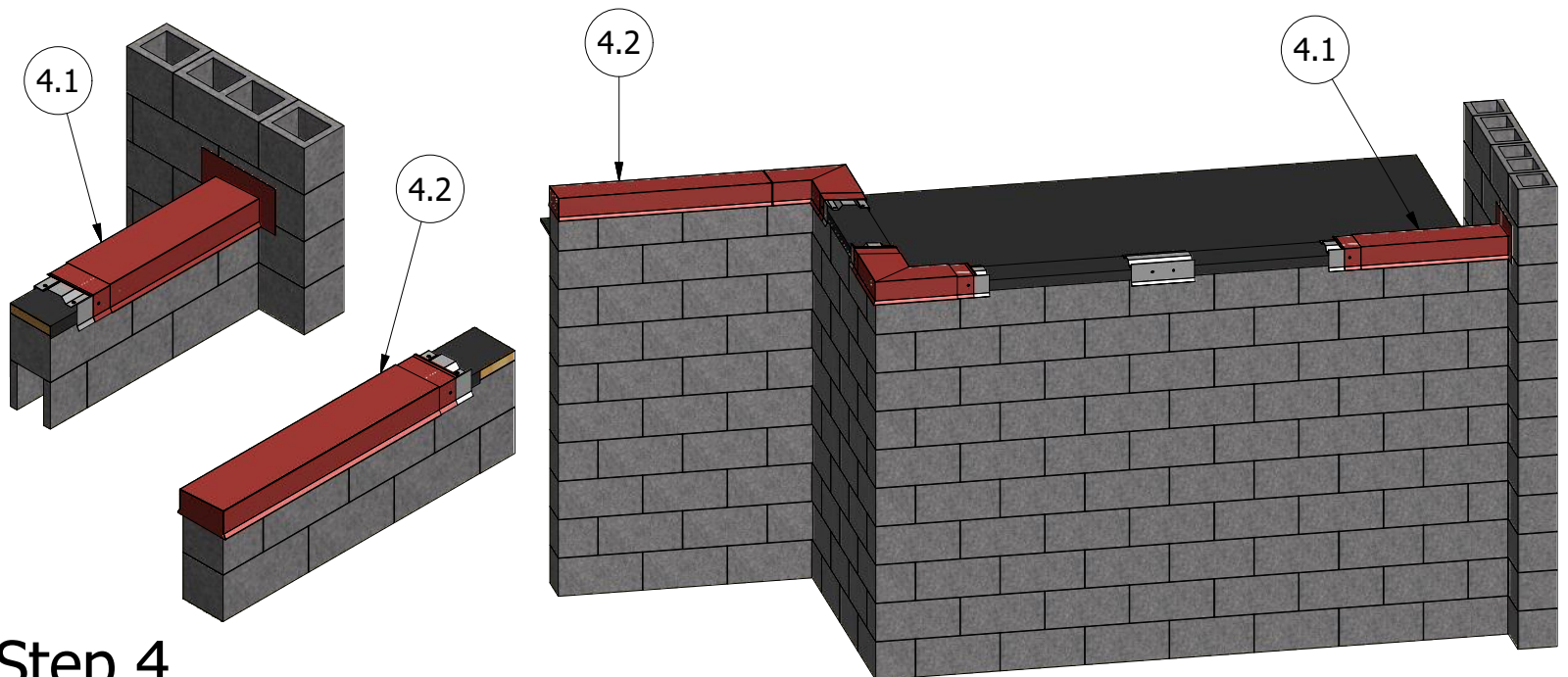

Step 4

Step 5.1 Install Rapid-Lok Coping Cover onto Cleat.

Step 5.2 Leave a Gap for expansion and contraction of Material.

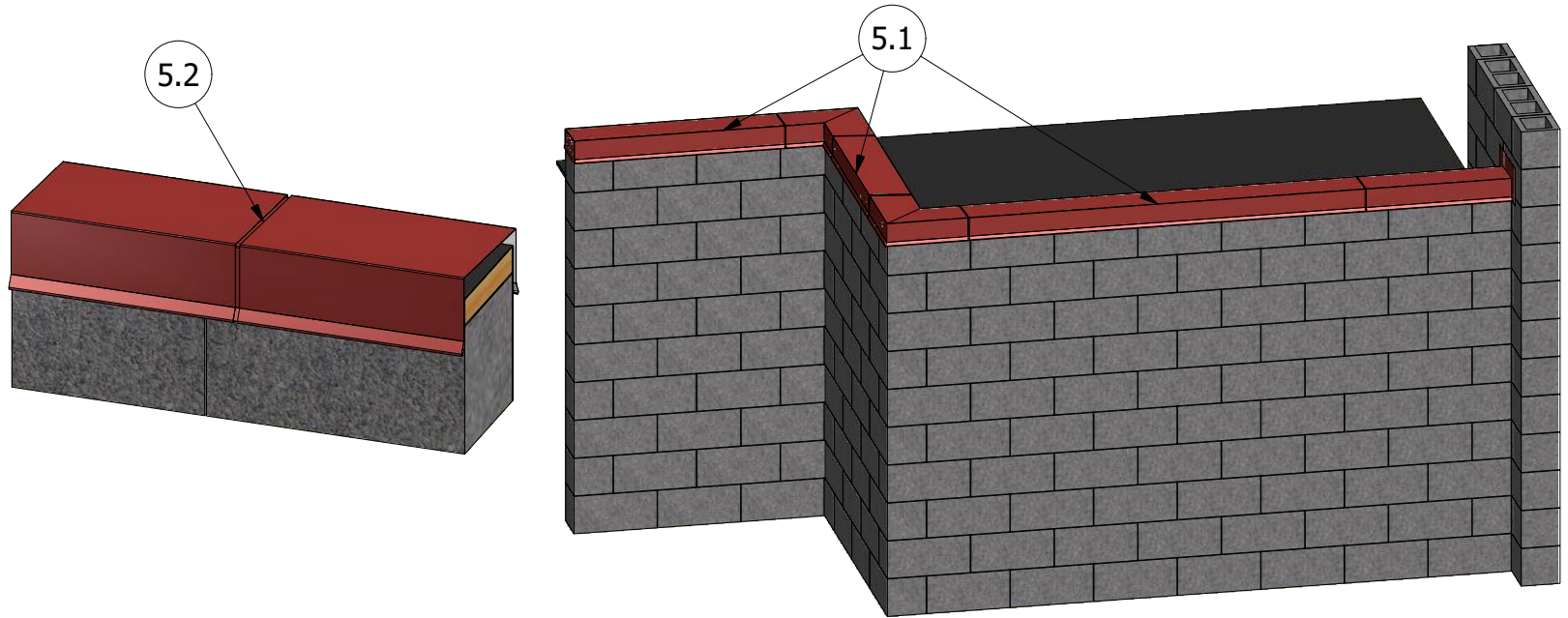

Step 5

Additional Details

For more information, please visit:

www.atas.com

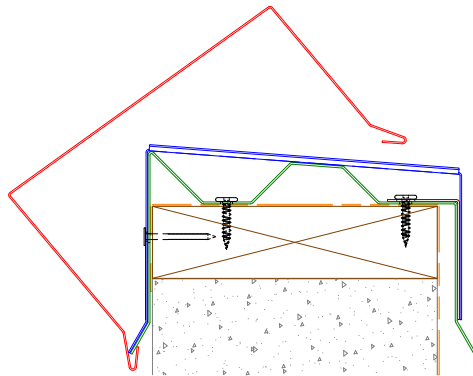

Engage Coping Cover Hem onto from Cleat as shown.

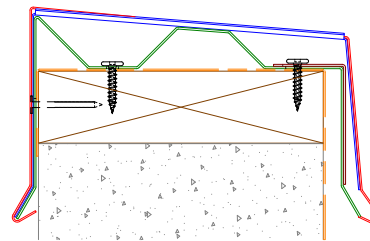

Roll Coping Cover Back onto Wall. Push down on top of Coping as shown.

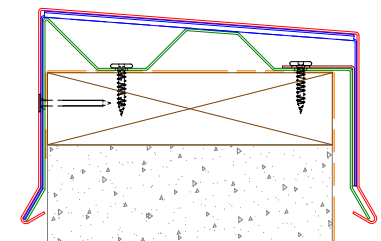

Release Coping once back Hem engages the Cleat

