



# FASTENING PATTERN GUIDE

---

# CONTENTS

Installation Guidelines.....	3
<b>BUR-8</b> Built-up or Selected Modified Bitumen Systems.....	4
<b>FA-8</b> Fully Adhered Single Ply Systems.....	5
<b>FA-11</b> Fully Adhered Single Ply Systems.....	6
<b>FA-16</b> Fully Adhered Single Ply Systems.....	7
<b>FA/HD-12</b> Fully Adhered Single Ply Systems.....	8
<b>FA/HD-16</b> Fully Adhered Single Ply Systems.....	9
<b>MF-5</b> Mechanically Fastened Single Ply Systems.....	10
<b>MF/RB-6</b> Mechanically Fastened Systems.....	11
<b>NB.1</b> Nailable Insulation Systems.....	12
<b>NB.2</b> Nailable Insulation Systems.....	13
<b>NB.3</b> Nailable Insulation Systems.....	14
Manufacturing and Sales Locations.....	15

# GENERAL INSTRUCTIONS & WARRANTY INFORMATION FOR ACFOAM® PRODUCTS

---

Before installation begins, the roof deck should be firm, well attached, even, clean and dry. Proper attachment of the insulation is necessary to prevent roof failures. Atlas is not responsible for any damage caused by improper attachment. ACFoam® products can be attached to decks that are approved by FM Approvals and local codes.

Atlas is not responsible for determining the suitability of the deck.

ACFoam® shall be kept dry before, during and after installation. Install only as much ACFoam® as can be covered the same day with completed roofing. Although ACFoam® has been designed to withstand normal foot traffic, protection from damage by construction traffic and/or abuse is extremely important. Roof surface protection such as plywood shall be used in areas where storage and staging are planned and heavy or repeated traffic is anticipated during or after installation. Refer to Atlas Technical Bulletin TB-5.

## MULTI-LAYER INSTALLATION

To minimize the effects of thermal bridging, Atlas strongly recommends the use of multiple layers when the total desired or specified R-value requires an insulation thickness greater than 2.7" thick. The joints in each layer should be offset in order to avoid a vertically continuous joint through the total insulation thickness. Two layers (or more) with joints staggered can provide improved insulation performance by eliminating thermal bridges. This method also reduces condensation potential.

## MECHANICAL ATTACHMENT

Mechanical fastening is the recommended method of attachment over nailable decks. General fastening frequency and spacing for steel, wood, cast-in-place structural concrete and poured gypsum decks is covered in the ACFoam® & Nailable Roof Insulation Fastening Pattern Guide. Refer to the current FM Loss Prevention Data Sheet 1-29 for special considerations regarding perimeter and corners of the roof. For further recommendations regarding attachment of insulation to lightweight insulating concrete decks or poured gypsum concrete decks, follow the instructions as outlined in the current NRCA Roofing Manual. ACFoam® products shall not be adhered directly to these decks by any bitumen or adhesive attachment method. Refer to the Nailable Insulation Guide for additional ACFoam® Nail Base and CrossVent® fastening recommendations.

## ADHESIVE ATTACHMENT

**(DOES NOT APPLY TO ACFOAM® COMPOSITE INSULATIONS, NAIL BASE OR CROSSVENT®.)**

For installing ACFoam® to a structural concrete deck, adhesive/bitumen attachment is the recommended method. When using hot bitumen on concrete decks, priming is necessary. Precautions must be taken to prevent bitumen drippage. When using hot-applied bitumen for insulation attachment, the temperature of the bitumen should be approximately 50°F below the interply hand mopping EVT. The deck must be dry and care must be taken to apply the bitumen in sufficient quantity to totally cover the available deck surface. Use 18 to 30 pounds of bitumen per square to ensure proper attachment. To ensure embedment, the board must also be "stepped in" at several points while the bitumen is still hot enough to allow positive attachment. The recommended ACFoam® insulation size for hot bitumen attachment is 4' x 4'. When using polyurethane adhesives or cold applied asphalt adhesive follow the adhesive manufacturer's installation recommendation. In any case, roll or weigh down the insulation to ensure contact between the adhesive and the insulation board.

## VAPOR/AIR RETARDERS

Moisture vapor tends to migrate from warmer to cooler areas. In building construction, vapor/air retarders are used to inhibit or block the passage of warm, moisture-laden air into walls or roofing assemblies. To determine whether a vapor/air retarder is necessary, calculations based on interior relative humidity, interior temperature, and the outside design temperature must be performed. Consult the current NRCA Roofing Manual for more information regarding vapor/air retarders and dew point calculations.

Special consideration should be given to construction-generated moisture as well. For example, construction generated moisture will be released when concrete floor slabs are placed after the roof has been installed, which can drive large quantities of moisture into the roof system. Therefore, Atlas is not responsible for damage to the insulation when exposed to construction-generated moisture. Refer to the current NRCA Roofing Manual for recommendations regarding the use of a vapor retarder when construction-generated moisture is present. Refer to Atlas Technical Bulletin TB-5. Consult vapor/air retarder manufacturer for recommended applications and details.

## STORAGE

Factory applied packaging is intended only for protection during transit. When stored outdoors or on the job site, the insulation should be stacked on pallets at least three inches above ground level and completely covered with a weatherproof covering such as a tarpaulin. The temporary factory-applied packaging should be slit or removed to prevent accumulation of condensation. Roof insulation which has become wet or damaged should be removed and replaced with solid, dry insulation.

## WARNING—DO NOT LEAVE EXPOSED

This product is a polyiso organic plastic foam and will burn if exposed to an ignition source of sufficient heat and intensity, or open flame, such as a welder's torch. Like other organic materials, this product will release smoke if ignited. Do not apply flame directly to ACFoam® roof insulations. This product should be used only in strict accordance with Atlas recommended uses and application instructions.

## LIMITATIONS OF LIABILITY

Other than the aforementioned representations and descriptions, Atlas Roofing Corporation (hereafter, "Seller") makes no other representations or warranties as to the insulation sold herein. The Seller disclaims all other warranties, express or implied, including the warranty of merchantability and the warranty of fitness for a particular purpose. Seller does, however, have a limited warranty as to the LTTR-value of the insulation, the terms of which are available upon request from the Seller.

The Seller shall not be liable for any incidental or consequential damages including the cost of installation, removal, repair or replacement of this product. The Buyer's remedies shall be limited exclusively to, at Seller's option, the repayment of the purchase price or resupply of product manufactured by Atlas in a quantity equal to that of the nonconforming product. Atlas distributors, agents, salespersons or other independent representatives have no authority to waive or alter the above limitation of liability and remedies.

CONNECTING FUNCTION WITH FACILITY™

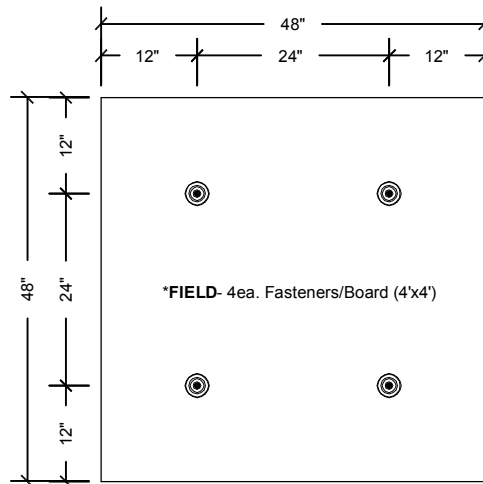
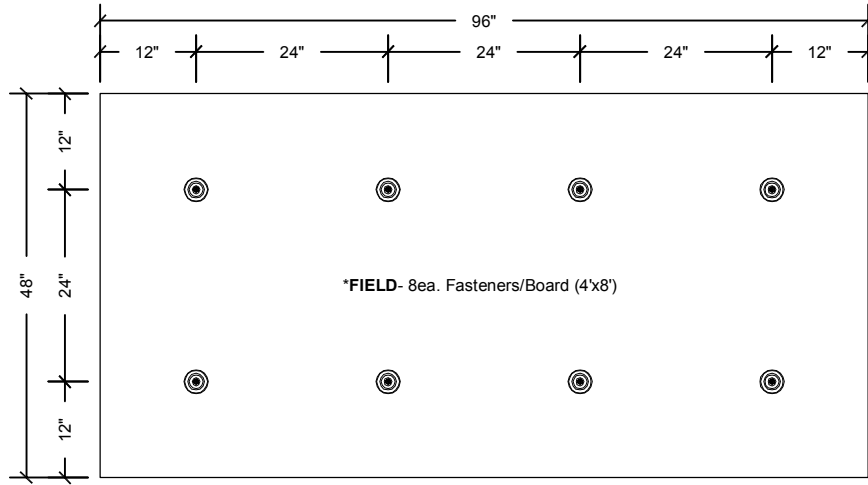

**NOTES:**

1. Minimum thickness of insulation shall be 1.3" ACFoam<sup>®</sup>-II or -III with mopped 0.5" Factory Mutual approved perlite overlay.
2. Minimum thickness of insulation shall be 1.5" ACFoam<sup>®</sup>-II or -III with mopped 0.5" Factory Mutual approved high density wood fiber overlay.
3. Refer to Factory Mutual Approval Guide for approved fasteners and plates.
4. Factory Mutual 1-90 Fastening Pattern.
5. Refer to Factory Mutual Global Property Loss Prevention Data Sheets (1-29) or consult roof system manufacturer for perimeter and corner design enhancement recommendations.



**ACFoam<sup>®</sup>-II | ACFoam<sup>®</sup>-III [ BUILT-UP OR SELECTED MODIFIED BITUMEN SYSTEMS ]**

ATLAS ROOFING CORPORATION HAS PRODUCED THIS INFORMATION FOR CONCEPTUAL DESIGN PURPOSES ONLY. Prior to installation, Atlas Roofing Corporation recommends that you consult your local building code(s), contract documents, professional engineer, FM Global, Miami-Dade County and membrane manufacturer for additional installation guidelines as well as design enhancements. Use of Atlas Roofing Corporation conceptual fastening patterns constitutes that the user has personally accepted all responsibility for verifying project specific fastening requirements prior to product installation.

DWG #: **BUR-8**

REVISION #: **2**

ISSUE DATE: **12/01/2016**

CONNECTING FUNCTION WITH FACILITY™

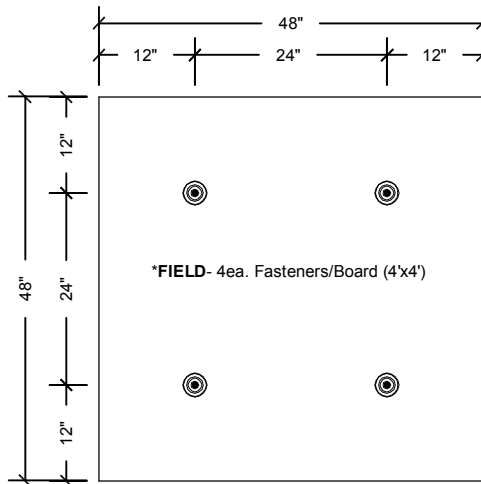
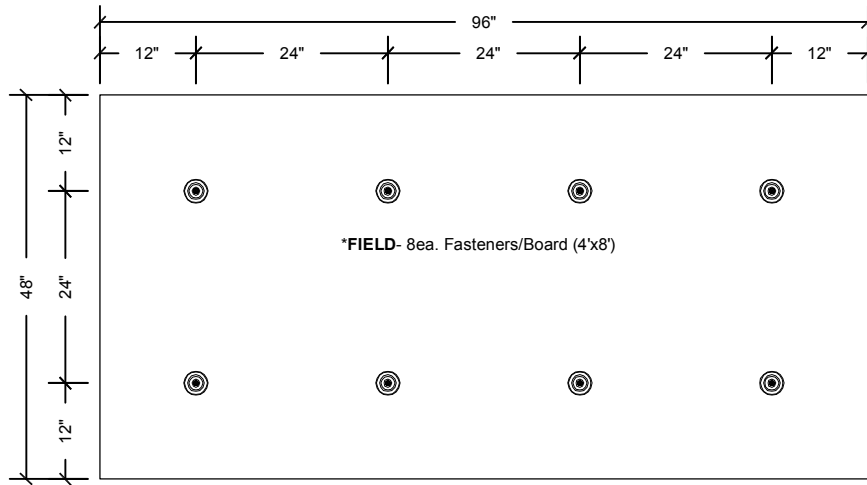

**NOTES:**

1. Minimum single layer thickness of insulation shall be 2.0".
2. Refer to Factory Mutual Approval Guide for approved fasteners and plates.
3. Factory Mutual 1-90 Fastening Pattern.
4. Refer to Factory Mutual Global Property Loss Prevention Data Sheets (1-29) or consult roof system manufacturer for perimeter and corner design enhancement recommendations.



**ACFoam<sup>®</sup>-II | ACFoam<sup>®</sup>-III [ FULLY ADHERED SINGLE PLY SYSTEMS ]**

ATLAS ROOFING CORPORATION HAS PRODUCED THIS INFORMATION FOR CONCEPTUAL DESIGN PURPOSES ONLY. Prior to installation, Atlas Roofing Corporation recommends that you consult your local building code(s), contract documents, professional engineer, FM Global, Miami-Dade County and membrane manufacturer for additional installation guidelines as well as design enhancements. Use of Atlas Roofing Corporation conceptual fastening patterns constitutes that the user has personally accepted all responsibility for verifying project specific fastening requirements prior to product installation.

**DWG #: FA-8**

**REVISION #: 1**

**ISSUE DATE: 12/01/2016**

CONNECTING FUNCTION WITH FACILITY™

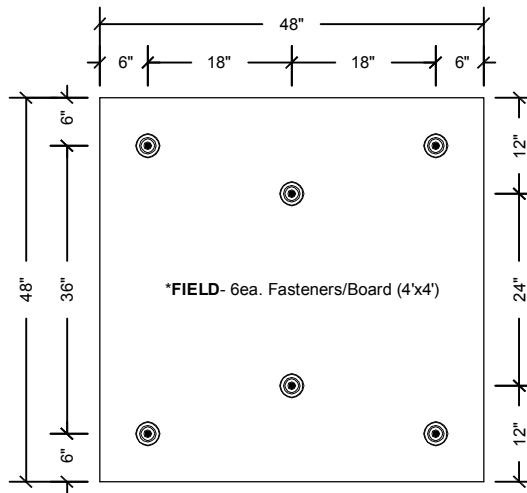
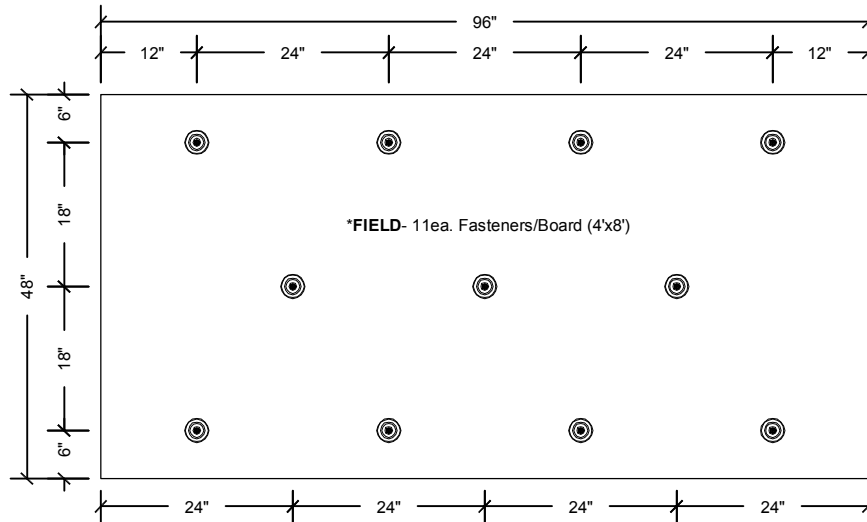

**NOTES:**

1. Minimum single layer thickness of insulation shall be 1.5" to 1.9".
2. Refer to Factory Mutual Approval Guide for approved fasteners and plates.
3. Factory Mutual 1-90 Fastening Pattern.
4. Refer to Factory Mutual Global Property Loss Prevention Data Sheets (1-29) or consult roof system manufacturer for perimeter and corner design enhancement recommendations.



**ACFoam<sup>®</sup>-II | ACFoam<sup>®</sup>-III [ FULLY ADHERED SINGLE PLY SYSTEMS ]**

ATLAS ROOFING CORPORATION HAS PRODUCED THIS INFORMATION FOR CONCEPTUAL DESIGN PURPOSES ONLY. Prior to installation, Atlas Roofing Corporation recommends that you consult your local building code(s), contract documents, professional engineer, FM Global, Miami-Dade County and membrane manufacturer for additional installation guidelines as well as design enhancements. Use of Atlas Roofing Corporation conceptual fastening patterns constitutes that the user has personally accepted all responsibility for verifying project specific fastening requirements prior to product installation.

DWG #: **FA-11**

REVISION #: **1**

ISSUE DATE: **12/01/2016**

CONNECTING FUNCTION WITH FACILITY™

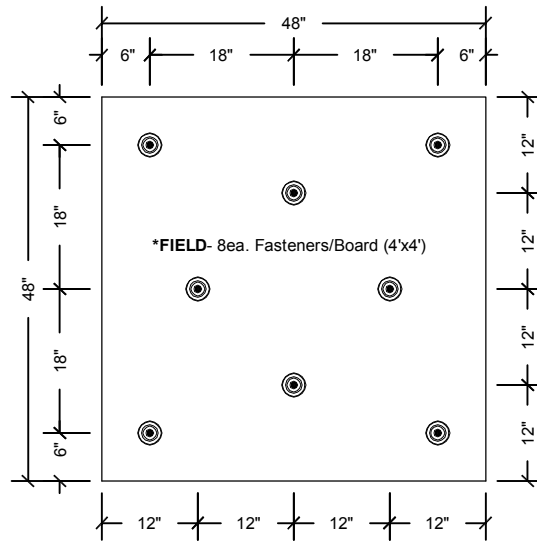
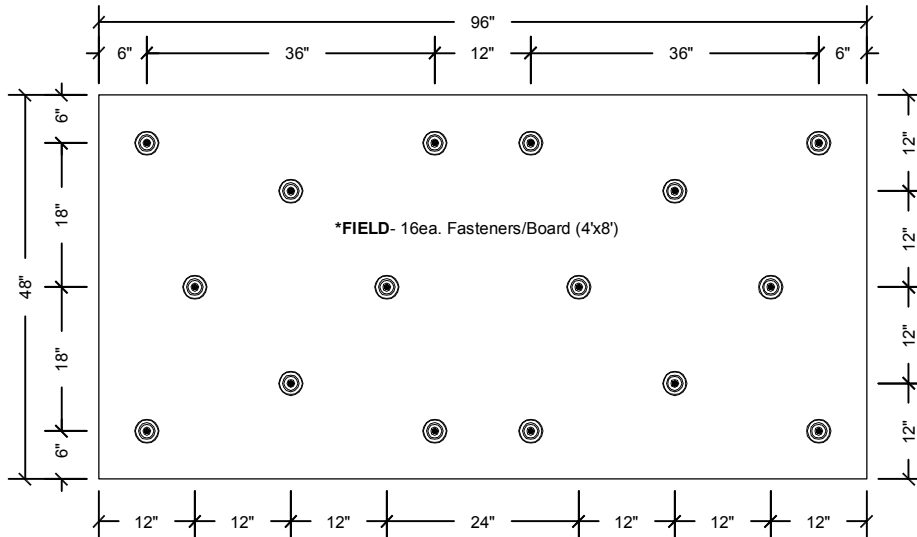

**NOTES:**

1. Minimum single layer thickness of insulation shall be 1.3" to 1.4".
2. Refer to Factory Mutual Approval Guide for approved fasteners and plates.
3. Factory Mutual 1-90 Fastening Pattern.
4. Refer to Factory Mutual Global Property Loss Prevention Data Sheets (1-29) or consult roof system manufacturer for perimeter and corner design enhancement recommendations.



**ACFoam<sup>®</sup>-II | ACFoam<sup>®</sup>-III [ FULLY ADHERED SINGLE PLY SYSTEMS ]**

ATLAS ROOFING CORPORATION HAS PRODUCED THIS INFORMATION FOR CONCEPTUAL DESIGN PURPOSES ONLY. Prior to installation, Atlas Roofing Corporation recommends that you consult your local building code(s), contract documents, professional engineer, FM Global, Miami-Dade County and membrane manufacturer for additional installation guidelines as well as design enhancements. Use of Atlas Roofing Corporation conceptual fastening patterns constitutes that the user has personally accepted all responsibility for verifying project specific fastening requirements prior to product installation.

**DWG #: FA-16**

**REVISION #: 1**

**ISSUE DATE: 12/01/2016**

CONNECTING FUNCTION WITH FACILITY™

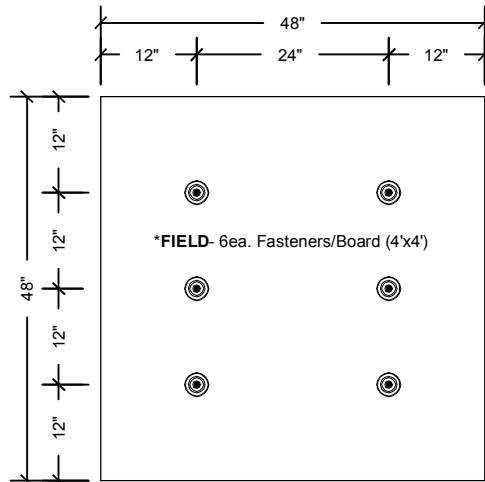
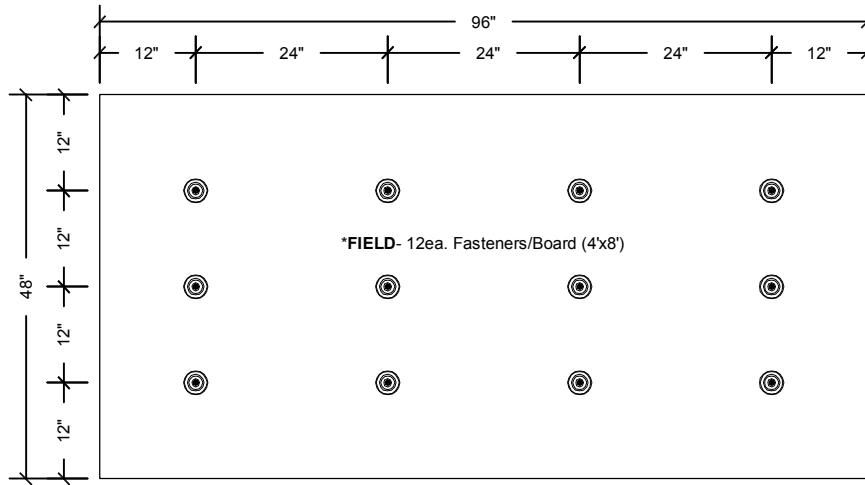

**NOTES:**

1. Refer to Factory Mutual Approval Guide for approved fasteners and plates.
2. Factory Mutual 1-75 Fastening Pattern.
3. Refer to Factory Mutual Global Property Loss Prevention Data Sheets (1-29) or consult roof system manufacturer for perimeter and corner design enhancement recommendations.



**ACFoam<sup>®</sup>-HD CoverBoard [ FULLY ADHERED SINGLE PLY SYSTEMS ]**

ATLAS ROOFING CORPORATION HAS PRODUCED THIS INFORMATION FOR CONCEPTUAL DESIGN PURPOSES ONLY. Prior to installation, Atlas Roofing Corporation recommends that you consult your local building code(s), contract documents, professional engineer, FM Global, Miami-Dade County and membrane manufacturer for additional installation guidelines as well as design enhancements. Use of Atlas Roofing Corporation conceptual fastening patterns constitutes that the user has personally accepted all responsibility for verifying project specific fastening requirements prior to product installation.

**DWG #: FA/HD-12**

**REVISION #: 1**

**ISSUE DATE: 12/01/2016**



CONNECTING FUNCTION WITH FACILITY™

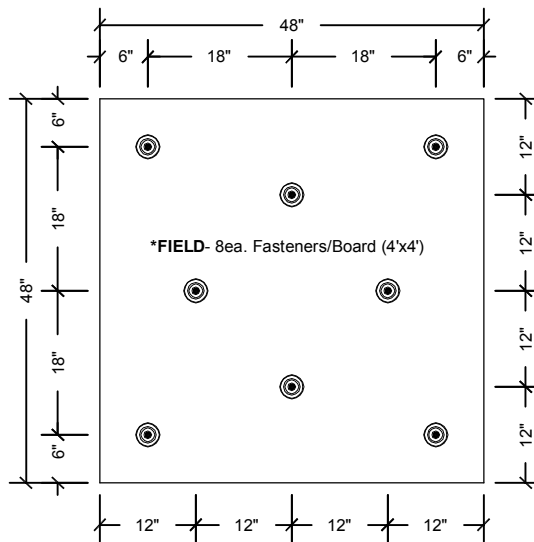
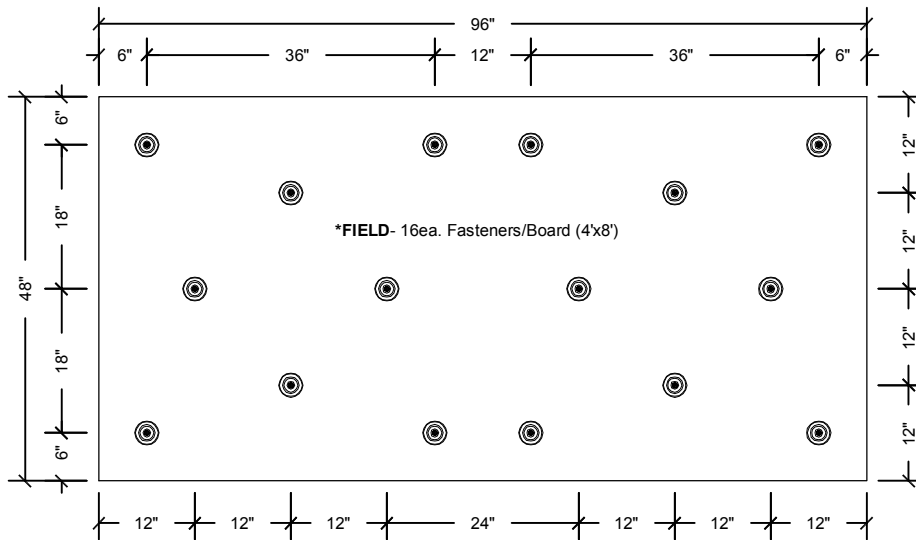

**NOTES:**

1. Refer to Factory Mutual Approval Guide for approved fasteners and plates.
2. Factory Mutual 1-90 Fastening Pattern.
3. Refer to Factory Mutual Global Property Loss Prevention Data Sheets (1-29) or consult roof system manufacturer for perimeter and corner design enhancement recommendations.



**ACFoam<sup>®</sup>-HD CoverBoard [ FULLY ADHERED SINGLE PLY SYSTEMS ]**

ATLAS ROOFING CORPORATION HAS PRODUCED THIS INFORMATION FOR CONCEPTUAL DESIGN PURPOSES ONLY. Prior to installation, Atlas Roofing Corporation recommends that you consult your local building code(s), contract documents, professional engineer, FM Global, Miami-Dade County and membrane manufacturer for additional installation guidelines as well as design enhancements. Use of Atlas Roofing Corporation conceptual fastening patterns constitutes that the user has personally accepted all responsibility for verifying project specific fastening requirements prior to product installation.

DWG #: **FA/HD-16**

REVISION #: **1**

ISSUE DATE: **12/01/2016**

CONNECTING FUNCTION WITH FACILITY™

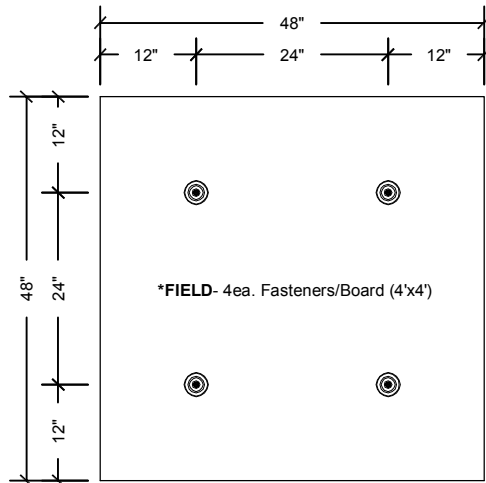
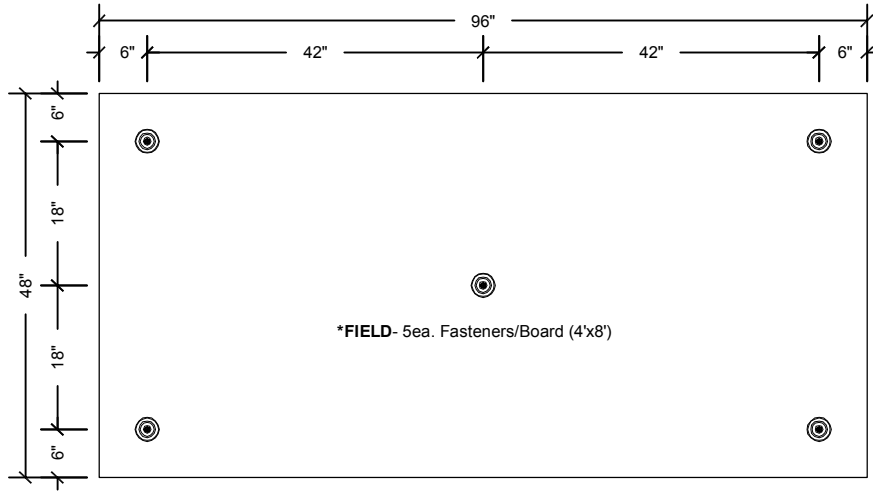

**NOTES:**

1. Minimum single layer thickness of insulation shall be 1.3".
2. Refer to Factory Mutual Approval Guide for approved fasteners and plates.
3. Factory Mutual 1-90 Fastening Pattern.
4. Refer to Factory Mutual Global Property Loss Prevention Data Sheets (1-29) or consult roof system manufacturer for perimeter and corner design enhancement recommendations.



**ACFoam<sup>®</sup>-II | ACFoam<sup>®</sup>-III [MECHANICALLY FASTENED SYSTEMS]**

ATLAS ROOFING CORPORATION HAS PRODUCED THIS INFORMATION FOR CONCEPTUAL DESIGN PURPOSES ONLY. Prior to installation, Atlas Roofing Corporation recommends that you consult your local building code(s), contract documents, professional engineer, FM Global, Miami-Dade County and membrane manufacturer for additional installation guidelines as well as design enhancements. Use of Atlas Roofing Corporation conceptual fastening patterns constitutes that the user has personally accepted all responsibility for verifying project specific fastening requirements prior to product installation.

DWG #: **MF-5**

REVISION #: **1**

ISSUE DATE: **12/01/2016**

CONNECTING FUNCTION WITH FACILITY™

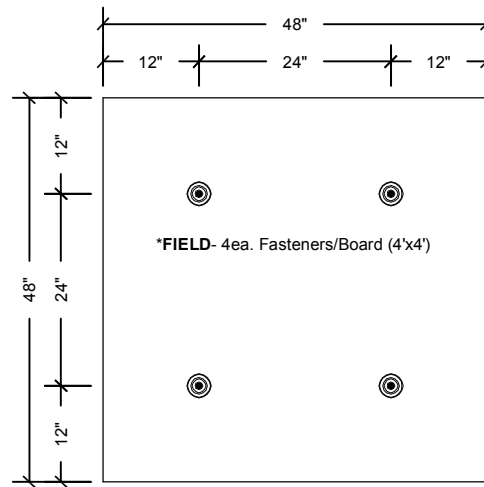
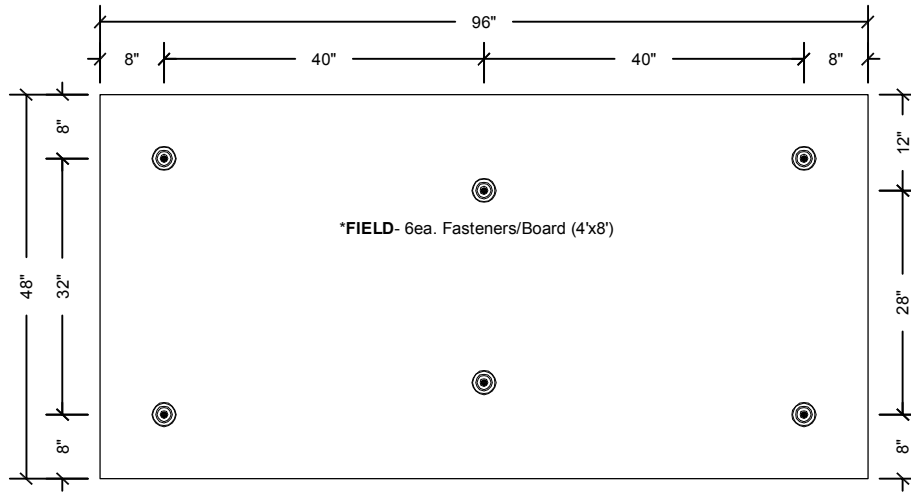

**NOTES:**

1. Minimum single layer thickness of insulation shall be 0.5".
2. Refer to Factory Mutual Approval Guide for approved fasteners and plates.
3. Factory Mutual 1-90 Fastening Pattern.
4. Refer to Factory Mutual Global Property Loss Prevention Data Sheets (1-29) or consult roof system manufacturer for perimeter and corner design enhancement recommendations.



**ACFoam**<sup>®</sup>-Recover Board [MECHANICALLY FASTENED SYSTEMS]

ATLAS ROOFING CORPORATION HAS PRODUCED THIS INFORMATION FOR CONCEPTUAL DESIGN PURPOSES ONLY. Prior to installation, Atlas Roofing Corporation recommends that you consult your local building code(s), contract documents, professional engineer, FM Global, Miami-Dade County and membrane manufacturer for additional installation guidelines as well as design enhancements. Use of Atlas Roofing Corporation conceptual fastening patterns constitutes that the user has personally accepted all responsibility for verifying project specific fastening requirements prior to product installation.

DWG #: **MF/RB-6**

REVISION #: **1**

ISSUE DATE: **12/01/2016**

CONNECTING FUNCTION WITH FACILITY™

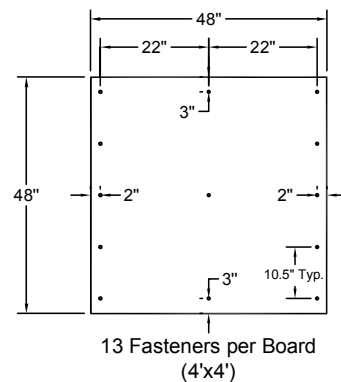
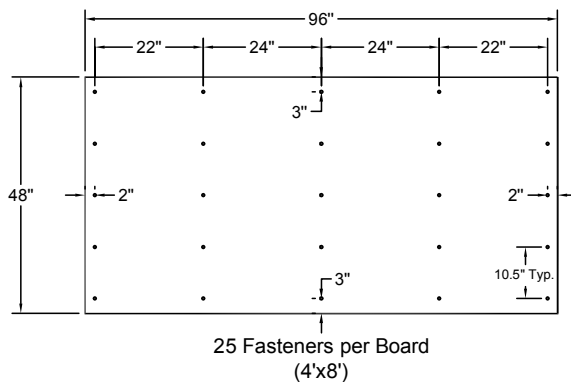
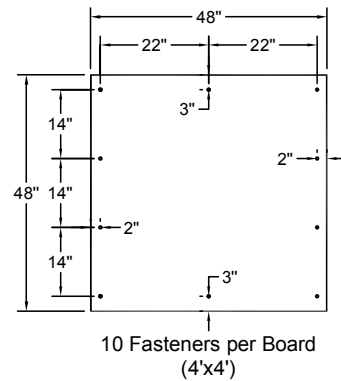
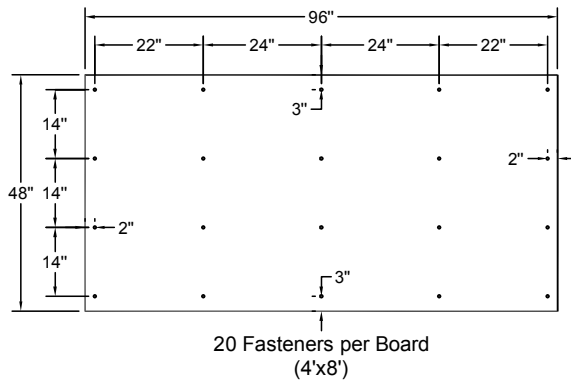
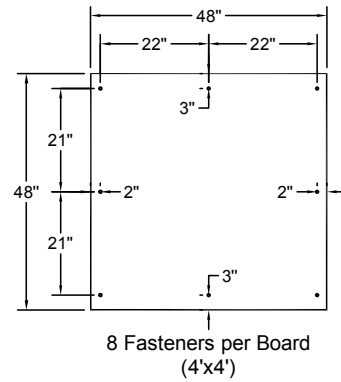
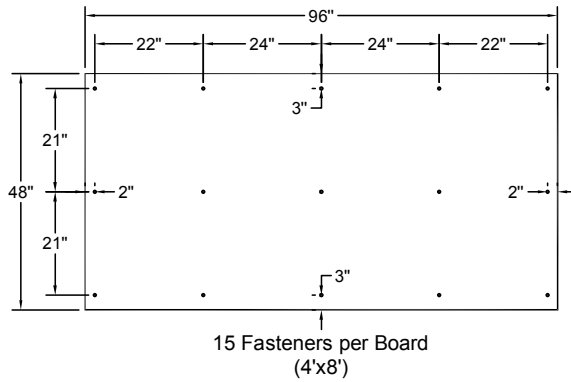

**NOTES:**

1. Minimum thickness of ACFoam<sup>®</sup> CrossVent<sup>®</sup> shall be 2.5" to meet FM 1-60, 1-90 or 1-105 requirements.
2. Minimum thickness of ACFoam<sup>®</sup> Nail Base shall be 1.5" to meet FM 1-60, 1-90 or 1-105 requirements.
3. Atlas Nail Base Fasteners required for attachment as part of Atlas ACFoam<sup>®</sup> Nailable Insulation Systems.
4. Refer to Atlas Nailable Insulation Guide for additional fastening requirements.



**ACFoam<sup>®</sup> Nail Base | ACFoam<sup>®</sup> CrossVent<sup>®</sup> [NAILABLE INSULATION SYSTEMS]**

ATLAS ROOFING CORPORATION HAS PRODUCED THIS INFORMATION FOR CONCEPTUAL DESIGN PURPOSES ONLY. Prior to installation, Atlas Roofing Corporation recommends that you consult your local building code(s), contract documents, professional engineer, FM Global, Miami-Dade County and membrane manufacturer for additional installation guidelines as well as design enhancements. Use of Atlas Roofing Corporation conceptual fastening patterns constitutes that the user has personally accepted all responsibility for verifying project specific fastening requirements prior to product installation.

DWG #: **NB.1**  
REVISION #: **1**  
ISSUE DATE: **12/01/2016**

CONNECTING FUNCTION WITH FACILITY™

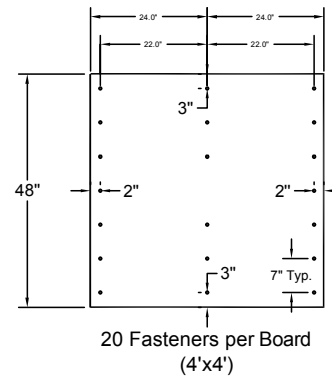
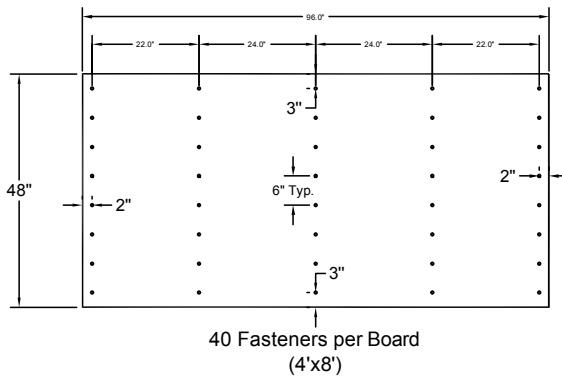
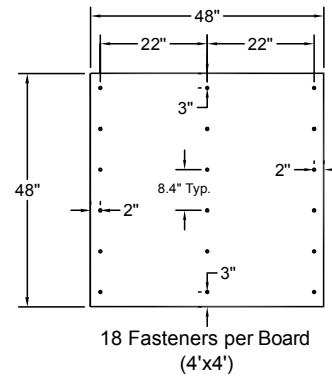
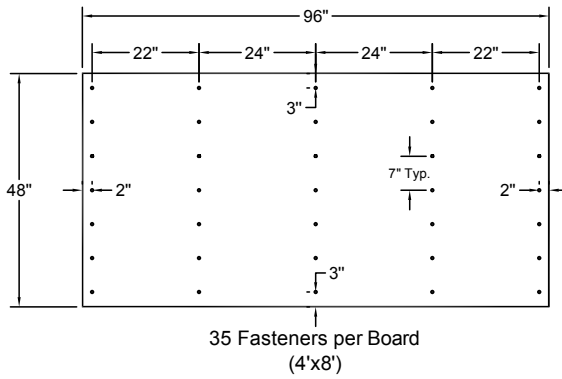
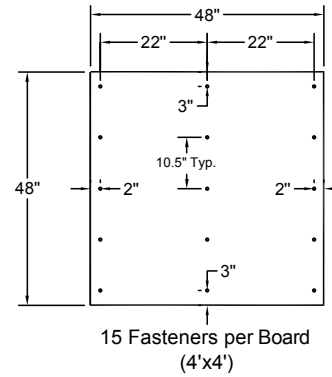
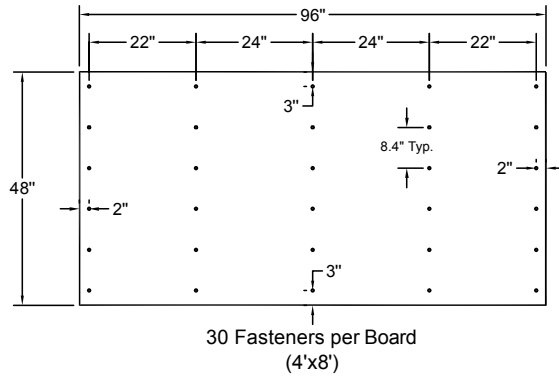

**NOTES:**

- Minimum thickness of ACFoam<sup>®</sup> CrossVent<sup>®</sup> shall be 2.5" to meet FM 1-60, 1-90 or 1-105 requirements.
- Minimum thickness of ACFoam<sup>®</sup> Nail Base shall be 1.5" to meet FM 1-60, 1-90 or 1-105 requirements.
- Atlas Nail Base Fasteners required for attachment as part of Atlas ACFoam<sup>®</sup> Nailable Insulation Systems.
- Refer to Atlas Nailable Insulation Guide for additional fastening requirements.



**ACFoam<sup>®</sup> Nail Base** | **ACFoam<sup>®</sup> CrossVent<sup>®</sup>** [ **NAILABLE INSULATION SYSTEMS** ]

ATLAS ROOFING CORPORATION HAS PRODUCED THIS INFORMATION FOR CONCEPTUAL DESIGN PURPOSES ONLY. Prior to installation, Atlas Roofing Corporation recommends that you consult your local building code(s), contract documents, professional engineer, FM Global, Miami-Dade County and membrane manufacturer for additional installation guidelines as well as design enhancements. Use of Atlas Roofing Corporation conceptual fastening patterns constitutes that the user has personally accepted all responsibility for verifying project specific fastening requirements prior to product installation.

DWG #: **NB.2**

REVISION #: **1**

ISSUE DATE: **12/01/2016**

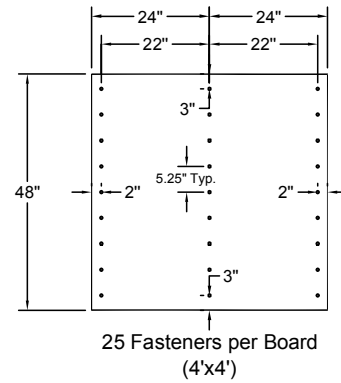
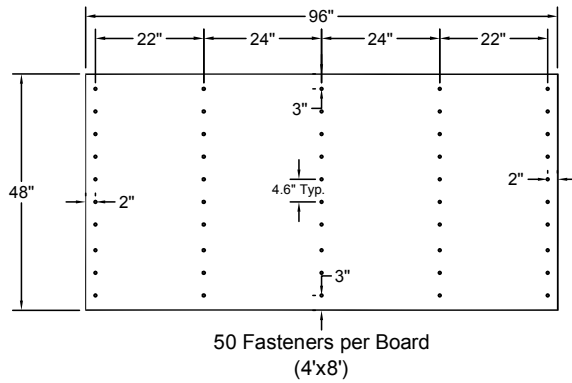
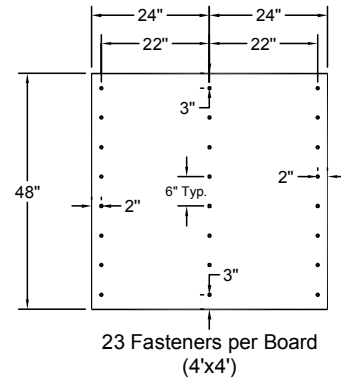
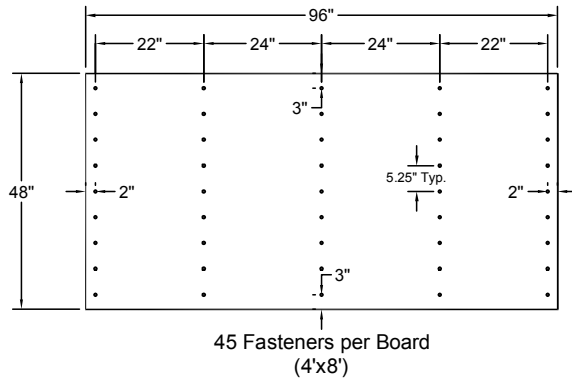

**NOTES:**

- Minimum thickness of ACFoam<sup>®</sup> CrossVent<sup>®</sup> shall be 2.5" to meet FM 1-60, 1-90 or 1-105 requirements.
- Minimum thickness of ACFoam<sup>®</sup> Nail Base shall be 1.5" to meet FM 1-60, 1-90 or 1-105 requirements.
- Atlas Nail Base Fasteners required for attachment as part of Atlas ACFoam<sup>®</sup> Nailable Insulation Systems.
- Refer to Atlas Nailable Insulation Guide for additional fastening requirements.



**ACFoam<sup>®</sup> Nail Base | ACFoam<sup>®</sup> CrossVent<sup>®</sup> [NAILABLE INSULATION SYSTEMS]**

ATLAS ROOFING CORPORATION HAS PRODUCED THIS INFORMATION FOR CONCEPTUAL DESIGN PURPOSES ONLY. Prior to installation, Atlas Roofing Corporation recommends that you consult your local building code(s), contract documents, professional engineer, FM Global, Miami-Dade County and membrane manufacturer for additional installation guidelines as well as design enhancements. Use of Atlas Roofing Corporation conceptual fastening patterns constitutes that the user has personally accepted all responsibility for verifying project specific fastening requirements prior to product installation.

DWG #: **NB.3**

REVISION #: **1**

ISSUE DATE: **12/01/2016**

**CONTACT US:**



**ATLAS ROOFING CORPORATION**

**Corporate Sales and Marketing**

2000 RiverEdge Parkway, Suite 800, Atlanta, GA 30328  
(770) 952-1442

[AtlasRoofing.com](http://AtlasRoofing.com)

**Sales Offices:**

**Camp Hill, PA**

(800) 688-1476

Fax: (717) 975-6957



**Northglenn, CO**

(800) 288-1476

Fax: (303) 252-4417

**Diboll, TX**

(800) 766-1476

Fax: (936) 829-5363

**Phoenix, AZ**

(800) 477-1476

Fax: (602) 477-8897

**East Moline, IL**

(800) 677-1476

Fax: (866) 740-6019



**Toronto, ON**

(888) 647-1476

Fax: (877) 909-4001

**LaGrange, GA**

(800) 955-1476

Fax: (706) 882-4047

**Vancouver, BC**

(855) 265-1476

Fax: (604) 395-8365