

Atlas Roofing Corporation

INSULATING SHEATHING



www.AtlasRoofing.com

▶ Sales Offices

Camp Hill, PA
(800) 688-1476
Fax: (717) 975-6957

Toronto, ONT
(888) 647-1476
Fax: (877) 909-4001

East Moline, IL
(800) 677-1476
Fax: (309) 752-7127

Diboll, TX
(800) 766-1476
Fax: (936) 829-5363

Northglenn, CO
(800) 288-1476
Fax: (303) 252-4417

Phoenix, AZ
(800) 477-1476
Fax: (480) 655-9209

LaGrange, GA
(800) 955-1476
Fax: (706) 882-4047



▶ WARRANTY:

Other than the preceding representations and descriptions, Atlas Roofing Corporation (hereafter, "Seller") makes no other representations or warranties as to the insulation sold herein. THE SELLER DISCLAIMS ALL OTHER WARRANTIES, EXPRESS OR IMPLIED, INCLUDING THE WARRANTY OF MERCHANTABILITY AND THE WARRANTY OF FITNESS FOR A PARTICULAR PURPOSE.

▶ LIMITATIONS OF LIABILITY:

Other than the aforementioned representations and descriptions, Atlas Roofing Corporation (hereafter, "Seller") makes no other representations or warranties as to the insulation sold herein. The Seller disclaims all other warranties, express or implied, including the warranty of merchantability and the warranty of fitness for a particular purpose. Seller does, however, have a limited warranty as to the R-value of the insulation, the terms of which are available upon request from the Seller.

The Seller shall not be liable for any incidental or consequential damages including the cost of installation, removal, repair or replacement of this product. The Buyer's remedies shall be limited exclusively to, at Seller's option, the repayment of the purchase price or resupply of product manufactured by Atlas in a quantity equal to that of the nonconforming product. Atlas distributors, agents, salespersons or other independent representatives have no authority to waive or alter the above limitation of liability and remedies.

WARNING: THIS PRODUCT WILL BURN.

DO NOT LEAVE EXPOSED. Sheathings must have 1/2" gypsum wallboard or other code-approved fire barrier installed between it and the occupied area of a building.

Atlas Roofing Corporation

INSULATING SHEATHING INSTALLATION GUIDE



TABLE OF CONTENTS	2
WHY POLYISO WALL INSULATION	2
ASHRAE STANDARD AND ROI	3
SHEATHING PRODUCTS	
Rboard®	4
Energy Shield®, Energy Shield® Plus, Energy Shield® Cavity Wall	5
Stucco-Shield®	6
3 PART SPECIFICATIONS	7
▶ INSTALLATION DETAILS	
Comparative R-values	8
Exterior Wall Applications	8
Fire-Resistant Wall Assembly (1 Hour)	9
Insulated Crawl Space	9
Interior Insulation Slab on Grade	10
Masonry Basement Wall (Above Grade)	10
Cavity Wall/Masonry Insulation	11
Cavity Wall	11
Metal Stud Wall Applications	12
Re-Siding	12
Stucco Applications (Hardcoat)	13
Stucco-Shield® Applications	13
Water Resistive Barrier Applications	14
Water Resistive Barrier Installation	15
Water Resistive Barrier Installation (continued)	15
WARRANTY & CONTACT INFORMATION	16

Zero Ozone Depleting, CFC and HCFC-Free polyiso insulating sheathing for any exterior wall application.



Why Polyiso Wall Insulation

There is a lot of talk today about looking for energy savings solutions that help reduce carbon footprints and make a positive impact on the environment. Atlas believes strongly in incorporating those ideas into the way we craft our products. While energy costs continue to rise, solution based building components have never been more important.

Benefits of Using Polyiso Wall Insulation

- Minimal weight
- Acts as vapor retarder
- Used in Water Resistive Barrier Systems
- Energy tax credits available
- Reduced energy cost in buildings
- Leed points available
- Energy Star rated product
- Acts as continuous insulation

▶ ASHRAE STANDARD 90.1 AND CONTINUOUS INSULATION

ASHRAE Standard 90.1 is the energy code reference in the International Building Code (IBC) and the International Energy Conservation Code (IECC). As such, this standard defines code minimums for the classes of constructions covered. In 2008, for the first time in over 19 years, ASHRAE increased the minimum required prescriptive R-value (resistance to heat flow) for roof and wall insulation levels in Standard 90.1.

The next IRC and IBC code cycles will require the installation of a layer of continuous insulation over the entire exterior of walls of residential and commercial construction. This requirement will provide for a “thermal break” and added R-value to the structure - making the building much more airtight and energy efficient, as compared to current and past required construction. Foam insulation with an R-value of 5 will be the minimum acceptable continuous insulation. Atlas can help you meet these needs with our versatile line of wall insulation products:

- Energy Shield®
- Energy Shield® Plus
- Energy Shield® Cavity Wall
- Rboard®
- Stucco Shield®

Atlas recommends installing thicker insulation than code requirements dictate and promotes Beyond the Code initiatives that work to create more energy efficient buildings today for a greener tomorrow.



▶ RETURN ON INVESTMENT

Measuring ROI

Measuring something as important as Return on Investment is not an easy task. ROI is dependent on many factors, including material cost, energy cost, building type, building use, government incentives, and much more. Many case studies have shown the benefits of using polyiso insulation in both energy savings and monetary return, however it is important to note that every situation will vary to some degree. What is certain is that increased R-values and proper installation of polyiso rigid board insulation can help dramatically reduce the energy loss through the building envelope. Polyiso is typically specified in both roof and wall applications and carries the highest R-value per inch of any rigid board insulation in the marketplace. For more information about tax incentives and credits specific to polyiso wall insulation Please visit [WWW. ATLASROOFING.COM](http://WWW.ATLASROOFING.COM).



Atlas is an industry pioneer, being the first to develop blowing agent technology for our polyiso insulation products that have both zero ozone depletion potential (ODP) and zero global warming potential (GWP). Atlas polyiso wall insulation provides the same sealing qualities as old-fashioned wood sheathing products, but offers the added benefits of high insulating R-values. The added R-values of Atlas insulating sheathing will save energy costs, year after year, throughout the life of your investment.

Atlas insulating sheathing materials are the most cost effective, energy efficient exterior wall insulation available in the marketplace. R-values range from 3.3 to 22.0, depending on thickness and facers. When properly installed, Atlas insulating sheathing will provide added insulation and yield immediate energy savings in both Commercial and Residential applications.





RBOARD®

Rboard® polyiso insulating sheathing is a versatile substrate that can be used behind a variety of exterior cladding. Rboard® is one of the most cost effective, energy efficient sheathing materials available in the marketplace. Builders who prefer the strongest available non-reflective polyiso faced insulation choose Rboard® for superior insulation qualities and easy installation. R-values range from 3.0 to 21.7, depending on thickness. Rboard® sheathing is a rigid polyiso foam insulation panel with a specially

coated patented facer on both surfaces. Rboard® is available for imprinting with your company name and is available in a variety of thicknesses.

Rboard® polyiso insulating sheathing can help meet or exceed the Model Energy Code. Don't burn money with high energy costs, insulate when you build or retrofit with Rboard® high performance sheathing.

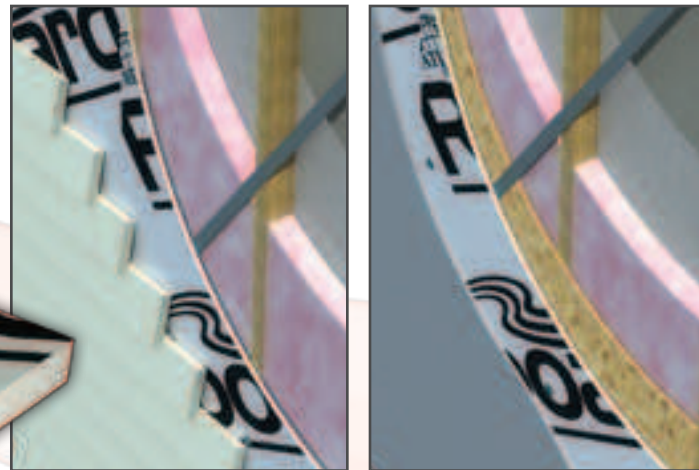

RBOARD® TECHNICAL DATA

Standard Thickness	in.	1/2"	5/8"	3/4"	1.0"	1.5"	2.0"	2.5"	3.0"	3.5"
	mm.	13	16	19	25	38	51	63.5	76.2	88.9
R-value*		3.0	3.8	4.5	6.0	9.0	12.1	15.3	18.5	21.7
RSI		.53	.67	.79	1.06	1.58	2.13	2.69	3.26	3.82

* Conditioned thermal values were determined by ASTM Test Method C 518 at 75 F mean temperature. All test specimens were conditioned in accordance with procedures outlined in ASTM C 1289-02, Section 11.1.2.1

CODES AND COMPLIANCES

Rboard® installed in a cavity wall complies with the requirements of the following building codes when properly installed:

- International Building Code, Section 1404.2 (ESR-1375)
- International Residential Code, Section R703 (ESR-1375)
- BOCA Building Code, Section 1404.3 (ESR-1375)
- Standard Building Code, Section 2603.3 (ESR-1375)
- Uniform Building Code, Section 1402.1 & 2506.4 (ESR-1375)
- Federal Specification, HH-1-1972
- ASTM C 1289 Standard for Polyiso Insulation - Type II, Class 2
- CCMC Evaluation Report, No. 12423-L (Meets CAN/CGSB 51.86-M86-Type 2)
- Miami-Dade County, Florida, 4/14/13, NOA No. 08-0111.01
- California State Insulation Quality Standards and Title 25 Foam Flammability Criteria- #TC 1231
- CAN/ULC S704-01, Type 2, Class C



ENERGY SHIELD®

Energy Shield® has trilaminate facers (foil-kraft-foil) on the top side and a trilaminate or solid foil facer on the unprinted back side. Energy Shield® can help meet or exceed the Model Energy Code and is available in a variety of thicknesses. R-values range from 3.3 to 22.0, depending on thickness.

ENERGY SHIELD® PLUS

Energy Shield® Plus sheathing is a rigid polyiso foam insulation panel with non-reflective trilaminate facer (foil-kraft-foil) on the top side and a trilaminate or solid foil facer on the unprinted back side. Energy Shield® Plus can help meet or exceed the Model Energy Code and is available in a variety of thicknesses. R-values range from 3.3 to 22.0, depending on thickness.

ENERGY SHIELD® CAVITY WALL

Energy Shield® Cavity Wall with its high R-value & moisture resistance installs into the narrow cavities of masonry construction. The optional 16" and 24" widths will fit between the masonry ties. Optionally, install Energy Shield® on the interior or the exterior side for increased R-value.

Foil-based facers help prevent moisture accumulation in the wall cavity. The stability provided by the thermoset foam core assures optimum performance. When sealed with a self adhering, flashing grade tape, the Energy Shield® envelope also acts as an air barrier and water resistive barrier. Can be used in foundation underslab applications. R-values range from 3.3 to 22.0, depending on thickness.



ENERGY SHIELD® TECHNICAL DATA

Product	Standard Thickness	in.	1/2"	5/8"	3/4"	1.0"	1.5"	2.0"	2.5"	3.0"	3.5"
		mm.	13	16	19	25	38	51	63.5	76.2	88.9
Energy Shield® Plus	R-value*		3.3	4.1	5.0	6.5	9.6	12.8	16.0	19.0	22.0
	RSI		.58	.72	.88	1.14	1.69	2.25	2.82	3.34	3.87
Energy Shield®	R-value*		3.3	4.1	5.0	6.5	9.6	12.8	16.0	19.0	22.0
	RSI		.58	.72	.88	1.14	1.69	2.25	2.82	3.34	3.87
Energy Shield® Cavity Wall	System R-value* with 3/4" Dead Air Space		-	-	-	9.3	12.4	15.6	18.8	21.8	-
	R-value*		-	-	-	6.5	9.6	12.8	16.0	19.0	-
	RSI		-	-	-	1.14	1.69	2.25	2.82	3.34	-

* System R-value is the product R-value plus the R-value of 2.8 as indicated in the ASHRAE Handbook Fundamentals, for 3/4" dead airspace with reflective foil one side. This information is for use in designing wall systems to comply with FTC Regulations.

** Conditioned thermal values were determined by ASTM Test Method C 518 at 75 F mean temperature. All test specimens were conditioned in accordance with procedures outlined in ASTM C 1289-07, Section 11.1.2.1

NOTE: Canada's CCMC has set all polyiso foam R-values at 6.0 per inch - straight line - for all available thicknesses. Published R-values are determined by ASTM C518 as noted above.



Energy Shield®

Energy Shield® Plus

Energy Shield® Cavity Wall



CODES AND COMPLIANCES

Energy Shield® installed in a cavity wall complies with the requirements of the following building codes when properly installed:

- International Building Code, Section 1404.2 (ESR-1375)
- International Residential Code, Section R703 (ESR-1375)
- BOCA National Building Code, Section 1404.3 (ESR-1375)
- Standard Building Code, Section 2303.3 (ESR-1375)
- Uniform Building Code, Section 1402.1 & 2506.4 (ESR-1375)
- Federal Specification, HH-1-1972
- ASTM C 1289 Standard for Polyiso Insulation - Type I, Class 1
- CCMC Evaluation Report, No. 12422-R (Meets CAN/CGSB 51.86-M86-Type 2)
- Miami-Dade County, Florida, 4/14/13, NOA No. 08-0111.01
- California State Insulation Quality Standards and Title 25 Foam Flammability Criteria- #TC 1231.
- CAN/ULC S704-01, Type 2, Class C

▶ STUCCO-SHIELD®

Stucco-Shield®, specialty polyiso insulating sheathing, is used as a substrate for polymer type & hard coat stucco systems. Stucco-Shield® is one of the most cost effective, energy efficient sheathing materials available in the marketplace. Builders who prefer a heavy coated facer for their stucco applications rely on Stucco-Shield®, the strongest available coated, non-reflective faced polyiso insulation panel available in the marketplace. R-values range from 3.0 to 12.1, depending on thickness.

Stucco-Shield® specialty sheathing is a rigid polyiso foam insulation panel with a specially coated patented facer on both surfaces. Stucco-Shield® polyiso insulated sheathing can help meet or exceed the Model Energy Code.

Don't burn money with high energy costs, insulate when you build or retrofit with Stucco-Shield® high performance sheathing.

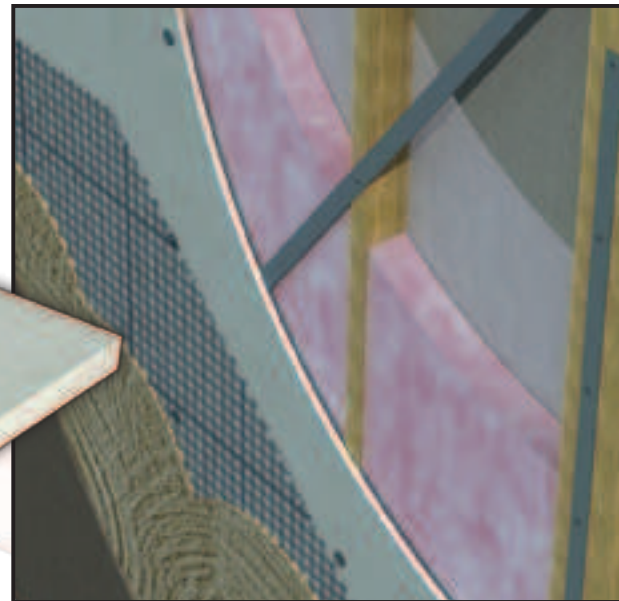

STUCCO-SHIELD® TECHNICAL DATA

Standard Thickness	in.	1/2"	3/4"	1.0"	1.5"	2.0"
	mm.	13	19	25	38	51
R-value*		3.0	4.5	6.0	9.0	12.1
RSI		.53	.79	1.06	1.58	2.13

* Conditioned thermal values were determined by ASTM Test Method C 518 at 75 F mean temperature. All test specimens were conditioned in accordance with procedures outlined in ASTM C 1289-02, Section 11.1.2.1

CODES AND COMPLIANCES

Stucco-Shield® installed in a cavity wall complies with the requirements of the following building codes when properly installed:

- International Building Code, Section 1404.2 (ESR-1975)
- International Residential Code, Section 2603
- Uniform Building Code, Section 2602
- International Conference of Building Officials, Section 2603.
- BOCA Building Code, Section 2603
- Standard Building Code, Section 2603
- Federal Specification, HH-1-1972
- ASTM C 1289 Standard for Polyiso Insulation - Type II, Class 2
- CCMC Evaluation Report, No. 12423-L (Meets CAN/CGSB 51.86-M86-Type 2)
- Miami-Dade County, Florida, 4/14/13, NOA No. 08-0111.01
- California State Insulation Quality Standards and Title 25 Foam Flammability Criteria- #TC 1231
- CAN/ULC S704-01, Type 2, Class C

ARCHITECTURAL SPECIFICATIONS : POLYISO FOAM INSULATING SHEATHING PANELS

SECTION 07210: BUILDING INSULATION

PART 1 GENERAL

1.01 SECTION INCLUDES

A. Rigid board type wall insulation(s) for thermal protection as part of wall assemblies.

B. Related Sections:

1. Section 06100: Rough Carpentry (framing).

1.02 REFERENCES

A. Refer to specific products for applicable standards and specifications of the following organizations / agencies:

1. American Society for Testing and Materials (ASTM).
2. Factory Mutual (FM).

1.03 SUBMITTALS

A. Comply with submittal procedures specified in Section 01330.

B. Product data: Manufacturer's specifications and installation instructions for polyiso foam core insulation board and fasteners.

C. Samples:

1. Submit 5 inch x 9 inch sample(s) of each board type required.
2. Submit sample(s) of each fastener type required.

D. Shop drawings: Wall framing design plan and fastening patterns.

E. Certificates: Manufacturer's certification that materials meet specification requirements.

1.04 QUALITY ASSURANCE

A. Regulatory Requirements:

*** VERIFY WITH APPLICABLE GOVERNING AGENCIES THE SPECIFIC STANDARDS TO BE COMPLIED WITH AND RETAIN, DELETE OR ADD ADDITIONAL REQUIREMENTS BELOW. ***

1. American Society for Testing and Materials (ASTM).
2. Federal Specifications (FS).
3. Factory Mutual (FM).
4. Metro-Dade County, Florida Product Control.
5. California State Insulation Quality Standards and Title 25 Foam Flammability Criteria.

6. IBC, BOCA, ICBO and SBCCI Sections on Foam Insulation.

7. Canadian Compliance: CAN/ULC-S704, CGSB-51.33-M89/CGSB-51.26-M86

1.05 DELIVERY, STORAGE AND HANDLING

A. Comply with general requirements specified in Section 01650.

B. Deliver insulation in packages labeled with material name, thermal value and product code.

C. When stored outdoors, stack insulation on pallets above ground and cover with tarpaulin or other suitable waterproof coverings. Slit or remove manufacturer's original packaging before covering with the job site waterproof covering, to prevent condensation accumulation.

1.06 PROJECT CONDITIONS

A. Comply with building code and / or insurance underwriter's requirements applicable for products of this Section.

B. Do not install insulation when insulation and / or framing is wet.

PART 2 PRODUCTS

2.01 MANUFACTURER

A. Provide polyiso insulating sheathing products as manufactured by Atlas Roofing Corporation, 2000 RiverEdge Parkway, Suite 800, Atlanta, GA 30328.

Ph. (770) 952-1442, Fax (770) 952-3170.

B. Local representative: *** INSERT NAME, ADDRESS AND PHONE NUMBER. ***

2.02 MATERIALS

A. *** SELECT ONE OR MORE OF THE INSULATION TYPES FROM THE LISTING BELOW, AS APPROPRIATE / CHOSEN BY THE DESIGNER. DELETE THE UNUSED ITEMS, AND RENUMBER APPROPRIATELY. ALSO - TYPICALLY MAKE PROPER PRODUCT SELECTION FROM ITEMS IN BRACKETS [] AND PARENTHESIS () AND DELETE ITEMS NOT USED. ***

1. Rboard®: Closed-cell polyiso foam core manufactured using patented, HCFC-free blowing agent technology and integrally laminated to heavy, coated, glass fiber facers; ASTM C1289, Type II, Class 1.

2. Stucco-Shield®: Closed-cell polyiso foam core manufactured using patented, HCFC-free blowing agent technology and integrally laminated to heavy, coated, glass fiber facers; ASTM C1289, Type II, Class 1

3. Energy Shield® and Energy Shield® Plus: Closed-cell polyiso foam core manufactured using patented, HCFC-free blowing agent technology and integrally laminated to tri-laminate foil or foil facers; ASTM C1289, Type I, Class 1
*** INSERT REQUIRED "R" VALUE BELOW. ***
B. Insulation "R" Value: _____ Determined in accordance with ASTM C 1289.

PART 3 EXECUTION

3.01 EXAMINATION

Examine framing for suitability to receive insulation. Verify that substrate is dry, straight, clean and free of foreign material that will damage insulation or impede installation.

1. Start of installation indicates installer accepts conditions of existing framing surfaces.

3.02 APPLICATION / INSTALLATION

*** VERIFY POSSIBLE NEED FOR A VAPOR RETARDER WITH DESIGNER IN ACCORDANCE WITH CURRENT VAPOR RETARDER THEORY AND ENGINEERING FORMULAS. WHEN REQUIRED, INSERT INSTALLATION REQUIREMENTS OF VAPOR RETARDER MANUFACTURER. ***

A. Install specified wall insulation panels using approved [mechanical fasteners] [adhesives] in accordance with manufacturer's latest written instructions and as required by governing codes and Owner's Design Professional.

B. Install with tight board to board joints to assure proper edge contact and thermal performance.

3.03 CLEANING / PROTECTION

A. Remove trash and construction debris from insulation and / or framing surfaces prior to application.

B. Do not leave installed insulation exposed to weather, long term. Cover within 60 days after installation.

1. Remove and replace installed insulation that has become damaged, with new insulation.
2. Allow wet insulation to air dry prior to installing the wall cladding.

END OF SECTION

COMPARATIVE R-VALUES OF SHEATHINGS IN AVAILABLE THICKNESSES

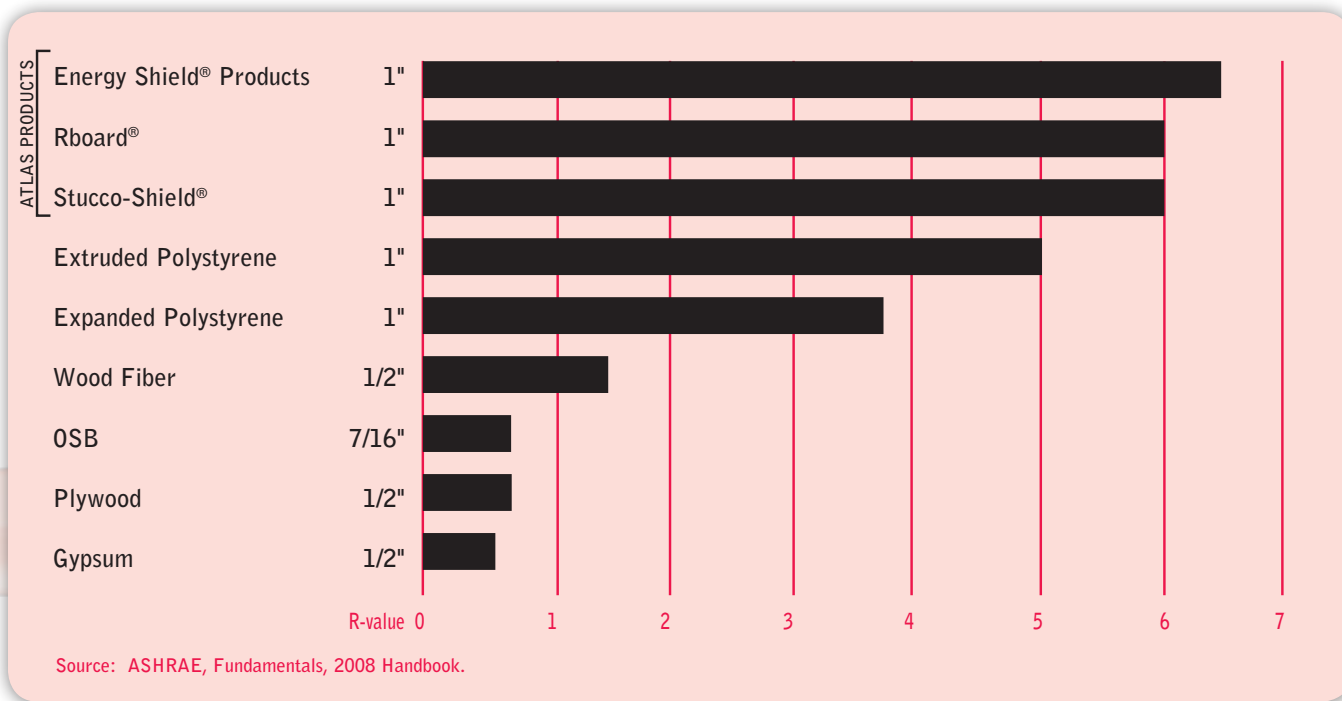

What you should know about R-values

R means resistance to heat flow. The higher the R-value, the greater the insulating power. Compare insulation R-values before you buy. There are other factors to consider. The amount of insulation you need depends mainly on the climate you live in. Also, your fuel savings from insulation will depend upon the climate, the type and size of your house, the amount of insulation already in your house, and your fuel use patterns and family size. To get the marked R-value, it is essential that this insulation be installed properly.

EXTERIOR WALL APPLICATIONS

1. Since Energy Shield®, Energy Shield® Plus and Rboard® are non-structural, an acceptable type diagonal corner bracing, using either metal strapping or "let-in-wood," must be installed.
2. Energy Shield®, Energy Shield® Plus and Rboard® sheathing should be installed vertically with sheathing edges bearing directly on framing members and vertical edges of abutting panels in moderate contact with each other. Avoid horizontal joints unless sheathing edges bear on horizontal framing members, printed side away from framing.
3. Secure the sheathing to framing member with 3/8" diameter head galvanized roofing nails long enough to penetrate framing a minimum of 3/4". Do not allow the nail head to penetrate the sheathing facer. Space fasteners 12" o.c. in both the field and perimeter.
4. Wood, brick, vinyl, hardboard and aluminum exterior sidings may be applied over Energy Shield®, Energy Shield® Plus or Rboard® and fastened through to the wall framing. Apply wood siding shingles in accordance with the shingle manufacturer's instructions after either furring strips or a plywood nailer base is installed over the sheathing. Some exterior hardboard and vinyl siding manufacturers do not recommend their products for use over foil faced insulation. Consult siding manufacturer.
5. 16" o.c. or 24" o.c. framing may be successfully used by following the spacing guide for fasteners printed on the insulation.

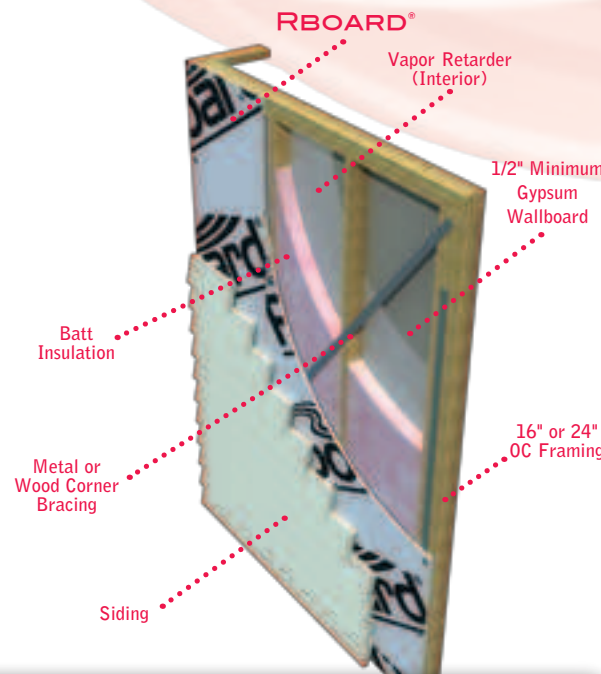

Energy Shield®, Energy Shield® Plus or Rboard® are ideally suited for most exterior wall applications because their light weight makes installation of high efficiency insulation easy and economical.

FIRE-RESISTANT WALL ASSEMBLY (1 HOUR)

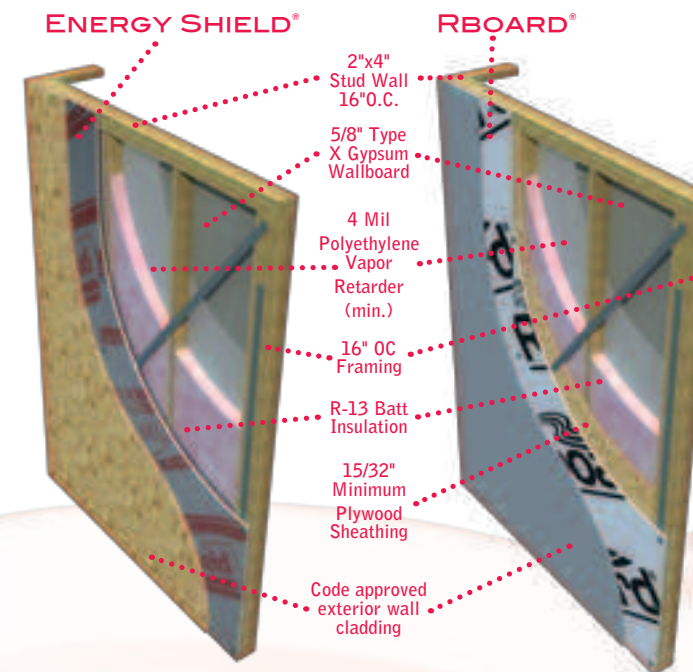

The wall assemblies shown with Energy Shield®, Energy Shield® Plus or Rboard® sheathing in the cavity are one-hour, load-bearing, fire-resistive wall systems. Energy Shield® & Energy Shield® Plus - WH Test Report #495-0585 and #495-0587. Rboard® - SwRI Report #01-4511-607.

1. Since Energy Shield® and Energy Shield® Plus are non-structural, an acceptable type of diagonal corner bracing using either metal strapping or "let-in-wood" must be installed. Rboard® installation does not require corner bracing because of the placement of plywood sheathing. (See diagram)
2. Energy Shield®, Energy Shield® Plus or Rboard® sheathing should be installed vertically, with sheathing edges bearing directly on framing members and vertical edges of abutting panels in moderate contact with each other. Avoid horizontal joints unless sheathing edges bear on horizontal framing members, printed side away from framing.
3. Secure to framing member with 3/8" diameter head galvanized roofing nails long enough to penetrate framing a minimum of 3/4". Do not allow the nail head to penetrate the sheathing facer. Space fasteners 12" o.c. in both the field and perimeter.
4. Any code-approved exterior wall cladding may be applied and fastened through to the wall framing. Apply exterior wall cladding in accordance with the specific manufacturer's installation instructions and in accordance with local code requirements.
5. 16" o.c. framing must be used.

NOTE: Contact Atlas for specific technical bulletins - Energy Shield® & Energy Shield® Plus: 92-1005; Rboard®: 92-1003.

Energy Shield®, Energy Shield® Plus and Rboard® can provide highly efficient insulation in fire-resistant wall assemblies.

INSULATED CRAWL SPACE

Foundation Wall:

1. Install a vapor retarder (minimum 4 mil polyethylene) over fill, up to and secured to the sill plate.
2. Install Energy Shield®, Energy Shield® Plus or Rboard® sheathing against wall, attaching to sill plate with galvanized roofing nails, or use adhesive beads to adhere to masonry.
3. Cover sheathing with a code approved thermal barrier, as required by local building codes.

Floor:

1. Grade crawl space floor to eliminate low spots and provide drainage to a soil pipe or sump.
2. Install a vapor retarder (minimum 4 mil polyethylene) over the entire grade. Lap all joints at least 24" and tape with vapor retarder tape.
3. Cover vapor retarder with Energy Shield®, Energy Shield® Plus or Rboard®.
4. Cover Rboard®, Energy Shield® or Energy Shield® Plus with aggregate, concrete or other suitable material.

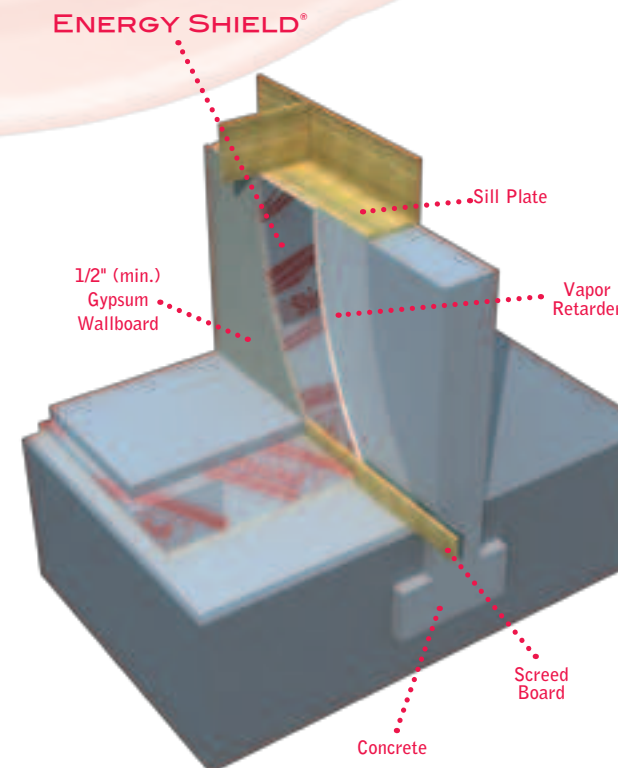

Energy Shield®, Energy Shield® Plus and Rboard® are ideally suited for insulating crawl spaces because of their light weight and easy fabrication.

▶ INTERIOR INSULATION SLAB ON GRADE

1. Install vapor retarder (minimum 4 mil polyethylene) over level, compacted fill. Extend vapor retarder up side walls, to sole plate.
2. Place Energy Shield®, Energy Shield® Plus or Rboard® sheathing over vapor retarder and up foundation wall as shown.
3. Pour concrete directly over Energy Shield®, Energy Shield® Plus or Rboard® sheathing.
4. Avoid damage during pouring of concrete.

Energy Shield®, Energy Shield® Plus or Rboard® will provide highly efficient insulation under concrete slab systems.

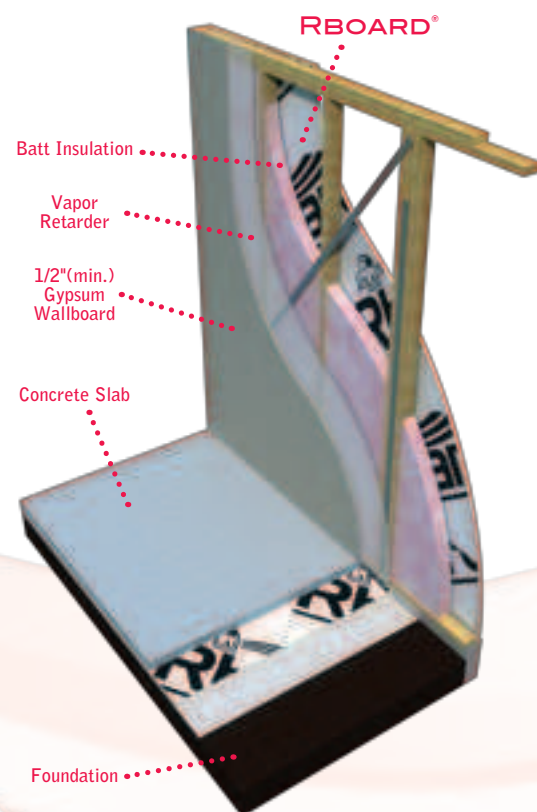

▶ CAVITY WALL/MASONRY INSULATION

Install 16" or 24" wide Energy Shield®, Energy Shield® Plus or Rboard® sheathing horizontally between masonry wall ties. Attach the insulation with masonry fasteners or construction adhesive to ensure complete contact with the wall.

Energy Shield®, Energy Shield® Plus: System R-value is the total R-value achieved when aluminum foil faced sheathing is installed next to a 3/4" air space in a wall. The product R-value added to 2.77 R-value of the air space (rounded to 2.8) provides the system R-value (See ASHRAE Handbook Fundamentals).

Energy Shield®, Energy Shield® Plus and Rboard® are recommended for cavity wall insulation in new masonry construction.

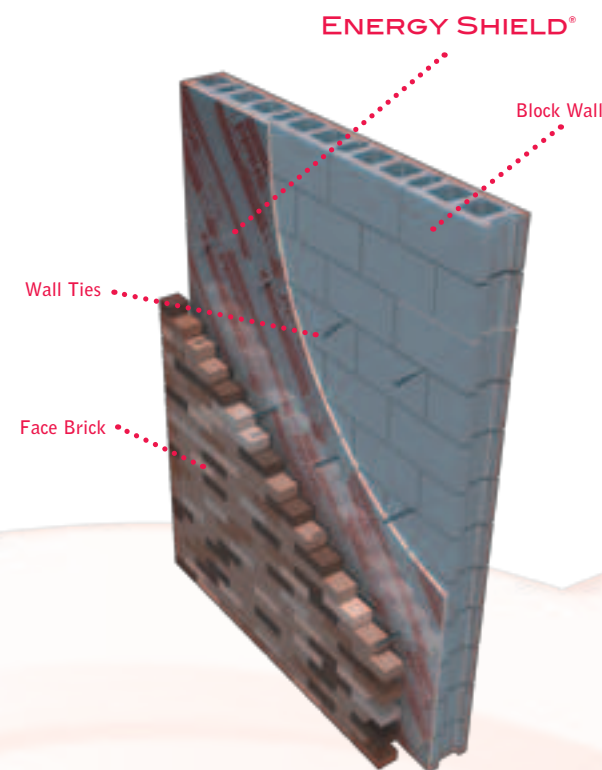

▶ FIRE-RESISTANT WALL ASSEMBLY (1 HOUR)

1. Install Energy Shield®, Energy Shield® Plus or Rboard® sheathing against the masonry using a small amount of construction adhesive and install a furring strip directly over the sheathing.
2. Space the furring strips a maximum of 16" o.c. and attach to the masonry with fasteners designed for this purpose, (e.g., Tapcon screws, or masonry nails) spaced 12" o.c. and penetrating the masonry a minimum of 1".
3. Cover the sheathing and furring strips with a minimum 1/2" gypsum wallboard, staggering the wallboard and sheathing joints.
4. Nail the 1/2" gypsum wallboard into the furring strips per gypsum board manufacturer's instructions.
5. Finish the gypsum wallboard with desired finishing materials.

Energy Shield®, Energy Shield® Plus and Rboard® should be selected as perimeter thermal insulations for above grade masonry basement wall installations because of their high thermal efficiency and thin profile.

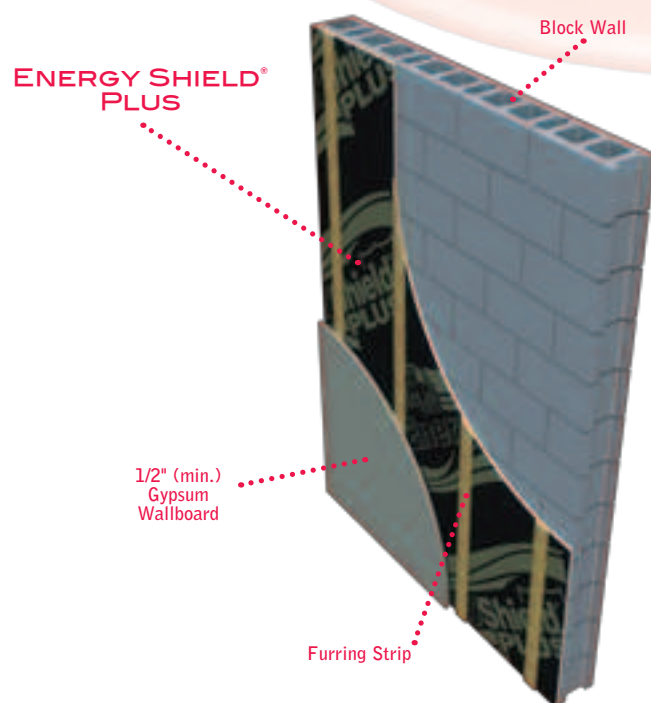

▶ CAVITY WALL TYPICAL CROSS SECTION

Cavity Walls install thin profile Energy Shield®, with its high R-value and moisture resistance, into the narrow cavities of masonry construction. Energy Shield® is easily installed as the exterior wall is being constructed. The optional 16" and 24" widths fit between the masonry ties. Energy Shield® is easily fabricated on the job. Block masonry walls' efficiency can also be supplemented for greater thermal resistance by the installation of Energy Shield®, on the interior or the exterior side.

The foil based facers shed water to help prevent moisture accumulation in the wall cavity. The stability provided by the thermoset foam core assures optimum performance at all extremes of temperatures found in a normal structure. When the board joints are sealed with a self adhering, flashing grade tape, the Energy Shield® envelope also acts as an air barrier.

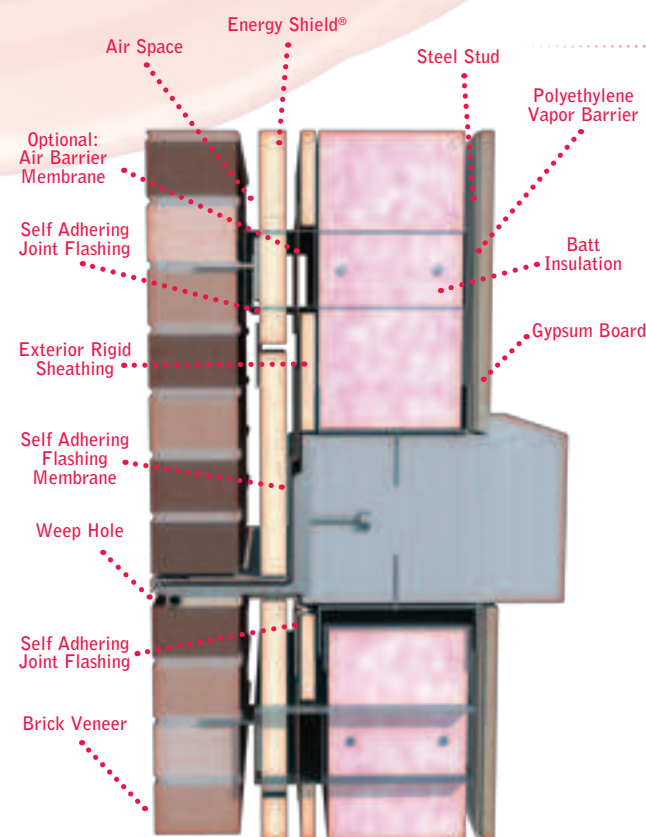

METAL STUD WALL APPLICATIONS

1. Adequate wind bracing must be incorporated into the wall assemblies.
2. Energy Shield®, Energy Shield® Plus or Rboard® sheathing should be installed vertically, with sheathing edges bearing directly on metal studs and vertical edges of abutting panels in moderate contact with each other. Avoid horizontal joints unless sheathing edges bear on horizontal framing members. The printed face should always be installed away from the framing.
3. Attach insulation boards with metal screws and washers or use construction adhesive to ensure full contact with the studs. Space fasteners 12" o.c. on all framing members.

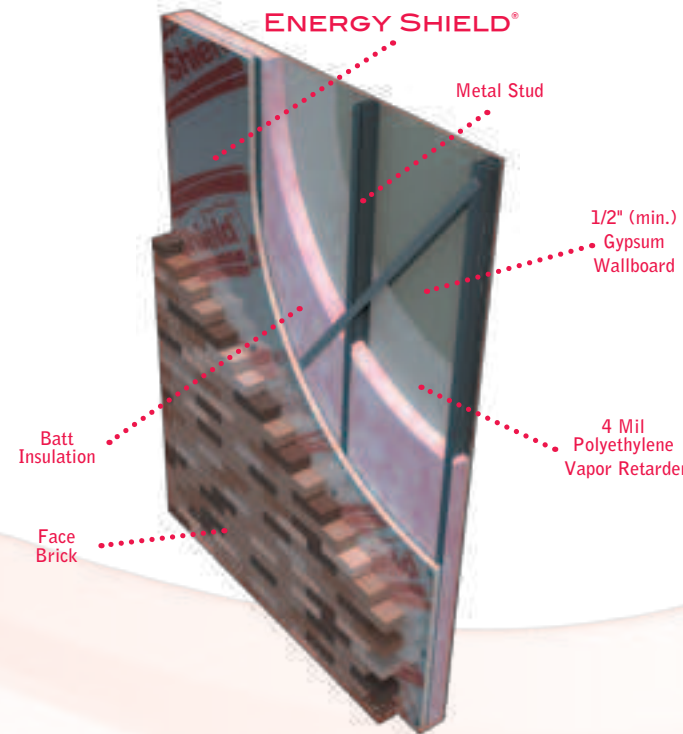

STUCCO APPLICATIONS (HARDCOAT)

1. Since Energy Shield®, Energy Shield® Plus, Rboard® or Stucco-Shield® are non structural, an acceptable type of diagonal corner bracing using either metal strapping or "let-in-wood" must be installed.
2. Vertically install Energy Shield®, Energy Shield® Plus, Rboard® or Stucco-Shield sheathing with minimum 1" thickness, making certain sheathing edges bear directly on framing members and vertical edges of abutting panels are in moderate contact with each other. Avoid horizontal joints unless sheathing edges bear on a horizontal framing member. Install with printed side facing the exterior.
3. Attach self-furring, corrosion-resistant metal lath to framing with 3/8" diameter head galvanized nail 1" longer than the sheathing. Space nails a maximum 6" o.c. on all framing.
4. Apply stucco in accordance with lath and stucco manufacturer's recommendations.

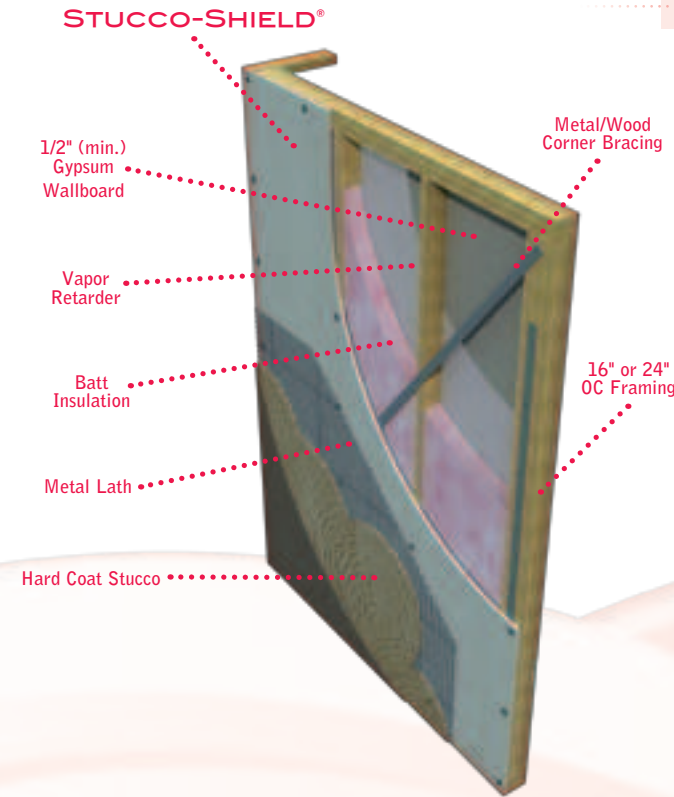

Either Energy Shield®, Energy Shield® Plus, Rboard® and Stucco-Shield® are recommended substrates between a hard coat exterior stucco finish and concrete, masonry or frame wall construction using metal lath.

RE-SIDING

1. Attach Energy Shield®, Energy Shield® Plus or Rboard® sheathing with 3/8" diameter head galvanized roofing nails long enough to penetrate solid wood 3/4" or 16 gauge wire staples having a minimum crown of 3/4" and legs long enough to penetrate solid wood 1/2". Space nails 12" o.c. on both the sheathing field and perimeter.
2. Corrective action should be taken where obvious moisture related damage has occurred. Possible corrective steps:
 - A. Repair and replacement of damaged areas.
 - B. Install an interior vapor retarder (paint-on or polyethylene sheet) to preclude future damage by moisture.
 - C. Provide adequate attic ventilation.
3. Install new siding per siding manufacturer's application instructions. Fasten new siding through the insulating sheathing into solid wood.

Energy Shield®, Energy Shield® Plus or Rboard® sheathing can be installed in a vertical or horizontal direction attached directly to old wood siding sound enough to support insulation.

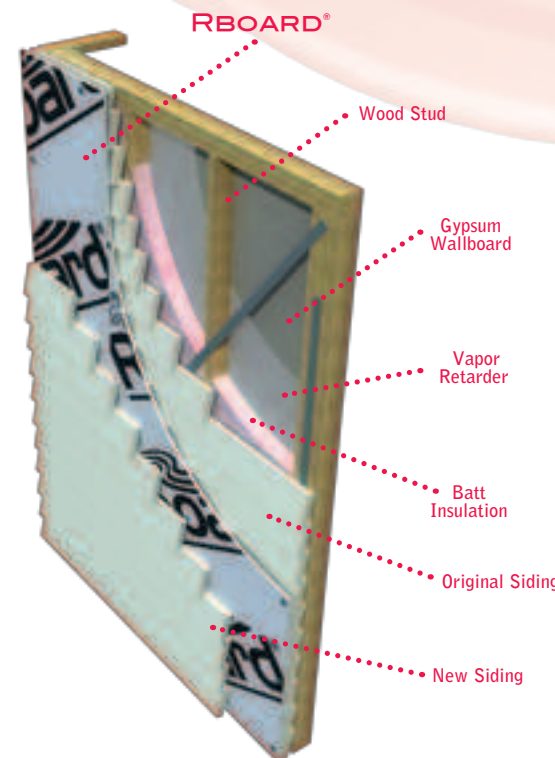

STUCCO-SHIELD® APPLICATION (EIFS)

- Stucco-Shield® as used in a typically installed EIFS on wood or metal framing.
1. Stucco-Shield®, printed side to building.
 2. Metal bracing or "let-in wood" for racking strength.
 3. Fasten 12" o.c. with plate and fastener as approved by stucco manufacturer.
 4. Metal or vinyl corner protector.
 5. Fiberglass reinforcement mesh. Full glass mesh coverage over the entire wall is necessary for best impact resistance and the long, maintenance-free life of the EIFS System.
 6. 16" o.c. stud spacing recommended. 24" spacing requires a horizontal nailer between studs, at mid-height.
 7. See edge detail drawings for proper edge wrap treatments. The stucco manufacturers' instructions should be followed for edge and joint treatments.

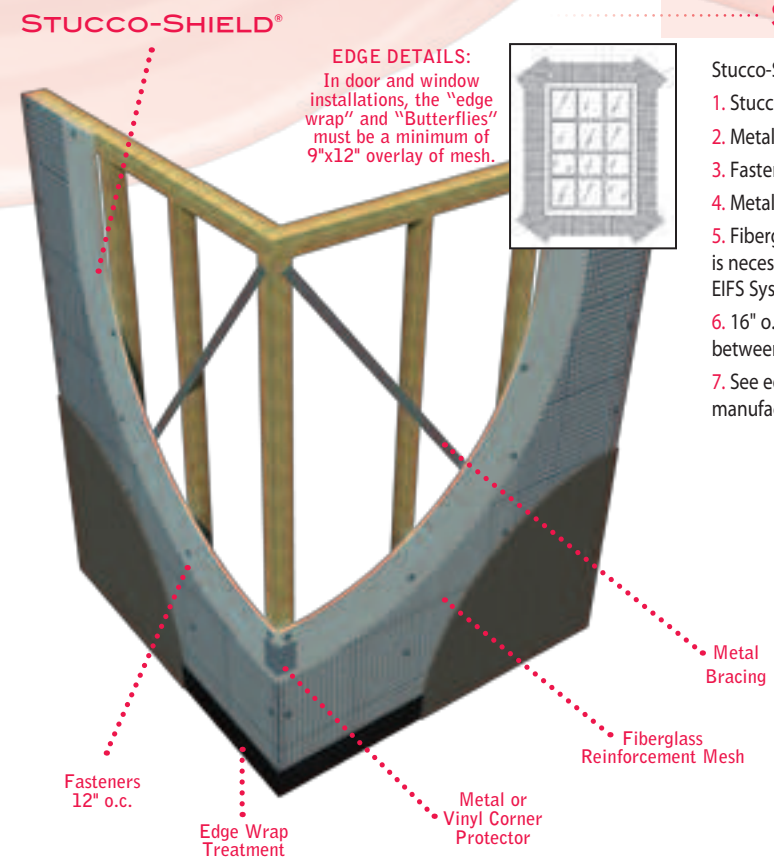

▶ WATER RESISTIVE BARRIER APPLICATIONS

An installed assembly of the following components will provide for a wall system recognized as a Water Resistive Barrier by the International Residential Code Report #ESR-1375.

- Install all insulating sheathing panels of Energy Shield®, Energy Shield® Plus, and/or Rboard®, per the standard sheathing installation instructions as shown in the Atlas Product Data Sheet:

Wood Framing—Fasten with min. 3/8" diameter head roofing nails, long enough to penetrate at least 3/4" into all supporting framing members. Install adjacent panels snugly to installed panels and assure reasonably good workmanship in cutting panels to fit around the features of the structure. Space fasteners @ 12" OC.

Steel Framing—Follow the same fastening pattern and procedure as above. Fasten with self drilling screws using minimum 3/4" diameter washer caps. Use care to avoid breaking the facing material when drawing the washer cap down to the face. Space fasteners @ 12" OC. Seal any broken panel facing areas with caulking, or flashing tape.

- Install window and door flanges over the surface of the Atlas insulating sheathing, per the installation instructions of the window or door manufacturer—assuring that all proper flashing and sealing is provided per those instructions.
- Flange mount units must have sealant (caulking) applied to the mounting surface of the Atlas insulating sheathing prior to positioning and securing the window flange through to the framing.
- Door unit installations must also follow the manufacturer's instructions regarding flashing details and all required sealant applications.
- Atlas recommends a minimum 1/4" wide bead of sealant under all of the door and window mounting flanges.

Energy Shield®, Energy Shield® Plus and Rboard® Applications: Flashing Tapes;

- Atlas WRB flashing tape 4" width Peel & Stick SBS modified, self-adhering flashing tape.
- Protecto-Wrap, BT-20XL brand, SBS modified, self-adhering flashing tape, minimum 4" width.
- RGM, Inc., KWIKWRAP brand, SBS modified, self-adhering flashing tape, minimum 4" width.

WATER RESISTIVE BARRIER SYSTEM

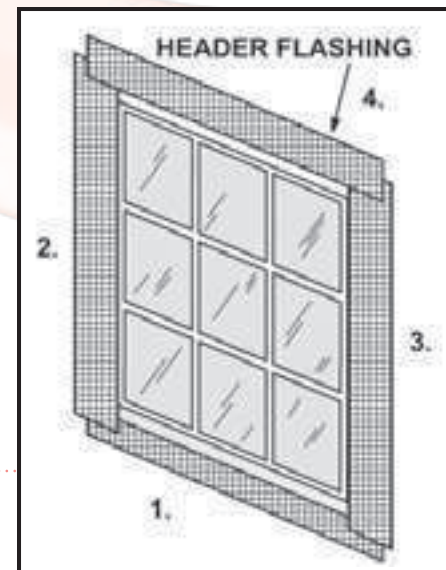

▶ WATER RESISTIVE BARRIER INSTALLATION

Taping and Sealing Procedures:

Follow all application instructions of the tape manufacturer. Assure that the mounting surface areas of the sheathing are clean where the flashing tape and sealant materials are to be applied. This is important to the adhesion qualities of the flashing tape and sealant products. Start the flashing tape application at the bottom of the wall assembly and work upward as you install the system's components. This will assure the basic function of the water shedding action of the flashing materials.

At ambient temperatures of less than 50 Degrees Fahrenheit, an asphalt-based primer, such as "Protecto Tac," is recommended to assure proper adhesion to various substrates and the foam panels.

Utilize a hard, hand roller to press the tape thoroughly onto the surface for best adhesive contact.

- Apply the flashing tape to all previously sealed/caulked and mounted, window flanges and door edge openings. Center the tape over the mounting flange edges. Tape all areas per the following procedures:

..... WATER RESISTIVE BARRIER INSTALLATION (CONTINUED)

1. Apply the flashing tape to the horizontal joints. The tape should be centered over all panel joints. Overlap all joints in the flashing tape by at least 3".
2. Apply the flashing tape to all vertical joints of the insulating panels, continuing over the junctures of the previously taped, horizontal joints.
3. All insulating panel joints must be taped. All window and door openings must be sealed and taped per these instructions as well as the window and door manufacturer's installation requirements. These instructions are designed to augment, not replace, the installation instructions of the door and window manufacturers. Apply tape in the numbered sequence shown below.
4. Tape all joints where insulating panes and wood structural panels meet. Do the same when taping insulating panel joints.
 - All other penetrations through the exterior of the wall assembly must be sealed and/or taped with these same materials to ensure a full Water Resistive Barrier system. Hose bibs, electrical access, dryer vents or any other wall penetration must be fully sealed/caulked.
 - Cover the wall assembly with a code approved exterior wall cladding as soon as is practical.

Atlas recommends that all of the wall cladding materials be installed within 60 days of installing this Water Resistive Barrier system of materials.

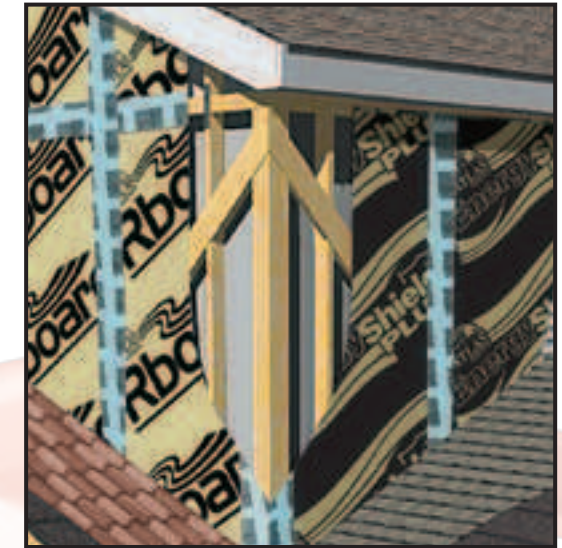

..... POLYISO EXTERIOR ROOF APPLICATIONS

Polyiso insulation can be used in exterior roof applications for Cathedral or A-frame ceilings. While Energy Shield and Rboard are suitable for these applications*, Atlas has specifically engineered products to accommodate the specific needs of steep slope roofs. The Atlas line of Polyiso Nailable insulations include ACFoam CrossVent, CrossVent RB, and Nail Base, all of which are manufactured with either a plywood or OSB substrate on the outer layer for ease of application. CrossVent provides a cross ventilating air space in various thicknesses, combining essential ventilation and energy efficient insulation. CrossVent is also available with a Radiant Barrier on the underside of the OSB, giving it the ability to transfer radiant heat away from the roof, thus keeping the attic cooler in the hot summer months. For information about ACFoam Nailable polyiso insulation, please visit www.AtlasRoofing.com/Nailable.

*Please contact the Atlas technical department for specific instructions before attempting this application.

