



INSTALLATION INSTRUCTIONS

EnergyShield® and EnergyShield® CGF

EnergyShield® and EnergyShield® CGF Installation Instructions

Conditions of Use

EnergyShield and EnergyShield CGF rigid foam insulation board complies with, or is a suitable alternative to, the applicable sections of the 2006, 2009 and 2012 IRC, and IBC and are subject to the following conditions:

- Installed in compliance with:
 - The applicable building code sections, which always supersede this instruction
 - Structural requirements
 - Fire requirements
 - Wind pressure requirements
 - Exterior wall covering requirements
 - Flashing requirements
 - Moisture barrier requirements
 - Air barrier requirements
 - Vapor barrier requirements
- TER No. 1205-05 Construction Details for the Use of Foam Plastic Insulating Sheathing (FPIS) in Light-Frame Construction, which always supersedes this instruction.
- NTA Report ATL041713-23 issued July 11, 2013, "Guide to Attaching Sheathing, Furring, and/or Cladding through Atlas Continuous Foam Insulation to Wood Framing, Steel Framing, Concrete, and CMU Substrates."
- Accessory manufacturer's instructions and recommendations for application over or behind foam board.
- This installation instruction. **See Note #1.**
- EnergyShield/EnergyShield CGF is not a nailing base for attachment of any kind.
- EnergyShield/EnergyShield CGF is not structural. **See Note #2.**
- This instruction pertains to EnergyShield and EnergyShield CGF.

Examination

- Inspect EnergyShield/EnergyShield CGF for damage related to transportation and handling.
- Ensure EnergyShield/EnergyShield CGF is suitable for installation.

- Segregate and discard EnergyShield/EnergyShield CGF damaged beyond repair and not fit for intended use.

Preparation

- Store EnergyShield/EnergyShield CGF indoors on risers elevated at least 4 inches above floor/grade. When EnergyShield/EnergyShield CGF must be stored outdoors, completely protect EnergyShield/EnergyShield CGF from moisture (Manufacturer's packaging is not sufficient protection from moisture).
- If building interior is not protected from exterior moisture, protect EnergyShield/EnergyShield CGF as if stored outdoors.
- Do not allow standing water to collect on top of protection or below EnergyShield/EnergyShield CGF.
- EnergyShield/EnergyShield CGF damaged by moisture is not fit for intended use and must be discarded.
- Take appropriate measures to secure EnergyShield/EnergyShield CGF from wind events. Do not exceed weight of 25 lbs. per square foot.
- If exterior temperature and/or materials are less than 55°F, a primer (check with tape manufacturer) may be required prior to installing sheathing tape and/or flashing tape.
- Follow sheathing tape and flashing tape manufacturer's instructions for specific EnergyShield/EnergyShield CGF preparation, primer application and required installation temperature.
- Install EnergyShield/EnergyShield CGF over clean, dry suitable framing spaced no more than 24 inches on center.
- EnergyShield/EnergyShield CGF may be left exposed no more than 60 days from date of installation.
- All wall applications are for above grade installations only.
- Keep open flame away from EnergyShield/EnergyShield CGF at all times.

APPLICATION #1

Installation of EnergyShield/EnergyShield CGF over structural sheathing or direct to structural wood/metal stud framing for continuous insulation.

EnergyShield/EnergyShield CGF Orientation

- Fasten EnergyShield/EnergyShield CGF through structural sheathing to wood/metal stud framing with printed facer visible. There are structural framing requirements to attach EnergyShield/EnergyShield CGF direct to framing. **See Note# 2.**
- Install EnergyShield/EnergyShield CGF with long edges parallel to wood/metal stud framing. Accessories such as masonry ties or other cladding attachments may dictate suitable orientation. **See Note# 3.**

Note #1: Instructions are for EnergyShield and EnergyShield CGF. Any recommendations for accessories are designed to supplement and defer to the window, door, tape, sealant, flashing, water resistive barrier, air barrier and fastener manufacturer's written instructions. Follow water resistive barrier and air barrier manufacturer's written instruction for attachment to EnergyShield/EnergyShield CGF. Follow cladding manufacturer's written, instruction for cladding attachment through EnergyShield/EnergyShield CGF to structure.

Note #2: Structural requirements can typically be achieved by code accepted shear or corner bracing such as advanced framing techniques, 1 inch by 4 inch wood let-in-bracing, metal strap cross bracing, inset shear panels, and structural sheathing at corners and at regular intervals to meet lateral loads. Always consult local building codes for appropriate solution.

Note #3: For multiple layer EnergyShield/EnergyShield CGF installations, offset vertical joints between first and second layers of EnergyShield/EnergyShield CGF by at least one stud cavity and horizontal joints by at least 6 inches.

Fasteners to Attach EnergyShield®/EnergyShield® CGF

- 3/8 inch head (9.5 mm) galvanized roofing nails, 3/4 inch wood stud framing penetration.
- 6D ring shank nails with 15/16 inch diameter plastic washers, 3/4 inch wood stud framing penetration. 7/16 inch crown 16 gage staples, minimum 1/2 inch wood stud framing penetration.
- 1 3/4 inches or larger diameter washer style fasteners, minimum 3/4 inch wood stud framing penetration or 1/4 inch minimum for metal stud framing. Plasti-Grip® IV Flat PM Washers by Rodenhouse or equivalent. One 1 3/4 inch or larger diameter washer style fastener at joint can bridge two boards. **See Note #3 and #4.**

Fastener Spacing to Attach EnergyShield/EnergyShield CGF

- EnergyShield/EnergyShield CGF field—every 16 inches on center. EnergyShield/EnergyShield CGF perimeter—every 12 inches on center. Place perimeter fasteners 3/8 of an inch from edge of board. When 1 3/4 inches or larger diameter washer style fastener are used, one fastener at perimeter joints can bridge two boards. **See Figure B.**
- Drive correct length fastener flush to EnergyShield/ EnergyShield CGF surface. Do not countersink fastener or washer.

EnergyShield/EnergyShield CGF Layout

- Use maximum length EnergyShield/EnergyShield CGF to minimize joints.

- Cut or split EnergyShield/EnergyShield CGF to fit between masonry ties if applicable or purchase EnergyShield/ EnergyShield CGF 16 or 24 inches wide.
- For a footing with a masonry veneer brick ledge, attach bottom edge of first course of EnergyShield/EnergyShield CGF to structural sheathing or sill plate 1/4 inch–1/2 inch above footing to allow clearance for drainage. If wood framing is installed flush with footing, place bottom edge of first course of EnergyShield/EnergyShield CGF even with bottom edge of structural sheathing or sill plate.
- Stagger EnergyShield/EnergyShield CGF joints from those of underlying exterior structural sheathing.
- Place the bottom edge of first course of EnergyShield/ EnergyShield CGF flush with exterior structural sheathing or bottom plate.
- Locate EnergyShield/EnergyShield CGF so that starting and ending edges overlap at outside AND inside corners and are fastened to the nearest wood stud or blocking. See Figure A.
- Fit EnergyShield/EnergyShield CGF tight at all joints, penetrations and features. **See Figure A.**
- Place top edge of last course of EnergyShield/EnergyShield CGF flush with vertical termination of structural sheathing or top plate.

IMAGE 1: WOOD FRAMING, WOOD SHEATHING, CONTINUOUS INSULATION, AIR/MOISTURE BARRIER WITH CLADDING OVER FURRING STRIPS

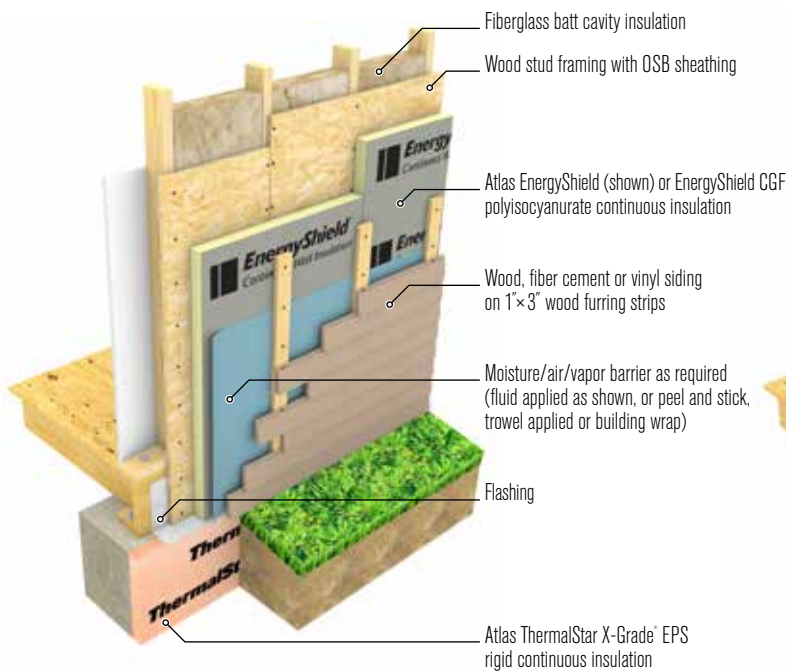
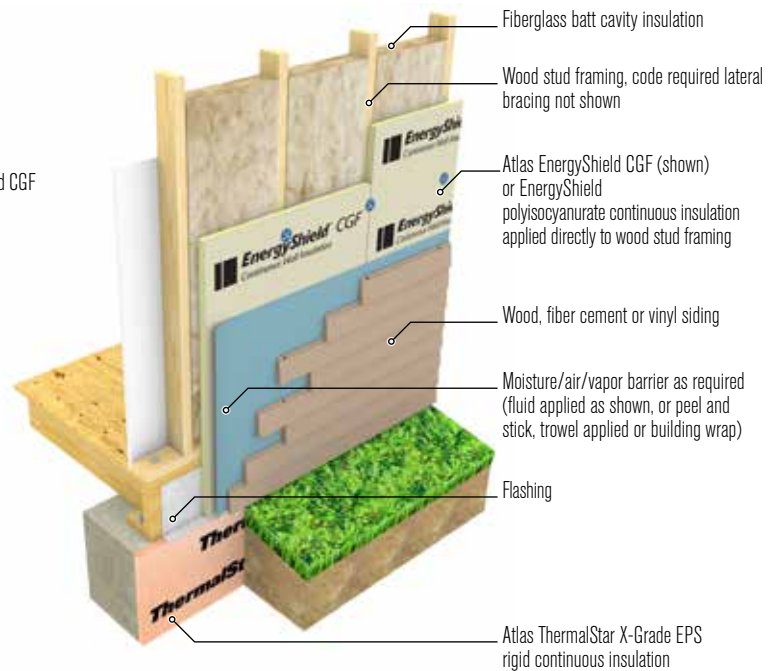

IMAGE 2: LATERALLY BRACED WOOD FRAMING, CONTINUOUS INSULATION, AIR/MOISTURE BARRIER WITH CLADDING



Note #3: For multiple layer EnergyShield/EnergyShield CGF installations, offset vertical joints between first and second layers of EnergyShield/EnergyShield CGF by at least one stud cavity and horizontal joints by at least 6 inches.

Note #4: Multiple layer EnergyShield/EnergyShield CGF installations may require specialty fasteners with sufficient length and engineering to span total EnergyShield/EnergyShield CGF thicknesses of 1 inch and greater. EnergyShield/EnergyShield CGF fasteners by Rodenhouse, CI Windlock and Hilti or equivalent are such examples. First layer may be tacked or glued in place until the second layer is installed with fasteners through to structure.

Note #5: Exterior cladding fastening systems which fasten to wood stud framing through EnergyShield/EnergyShield CGF are often sufficient to fasten EnergyShield/EnergyShield CGF for a complete installation. In these cases, the installer can determine sufficient fasteners or adhesives to temporarily secure EnergyShield/EnergyShield CGF to meet project environmental conditions until the cladding system can anchor EnergyShield/EnergyShield CGF to structure.

APPLICATION #2

Installation of EnergyShield/EnergyShield CGF over masonry wall for interior OR exterior continuous insulation.

Orientation for Masonry Wall

- Fasten or adhere EnergyShield®/EnergyShield® CGF to face of masonry wall with printed facer visible.
- For footings with masonry veneer brick ledges, place bottom edge of first course of EnergyShield/EnergyShield CGF ¼ inch–½ inch above footing to allow clearance for drainage.
- Install EnergyShield/EnergyShield CGF with long edges parallel to footing. Accessories such as masonry ties or other cladding attachments may dictate suitable orientation.

Fasteners For Masonry Wall When Brick Ties Are Installed Through EnergyShield/EnergyShield CGF joints.

- Masonry fastener with minimum 1¾ inch diameter washer, 1 inch minimum masonry penetration. Plasti Grip IV Flat PM Washer by Rodenhouse or equivalent.

Fastener Spacing for Masonry Wall

- EnergyShield/EnergyShield CGF field—every 16 inches on center. EnergyShield/EnergyShield CGF perimeter—every 12 inches on center. One 1¾ inch washer style fastener at joint can bridge two boards. **See in Figure B.**
- Drive correct length fastener flush to EnergyShield/EnergyShield CGF surface. Do not countersink fasteners or washers.

EnergyShield/EnergyShield CGF Adhered to Masonry Wall

- An alternative to using fasteners alone, adhere EnergyShield/EnergyShield CGF to masonry wall with suitable construction adhesive. Follow adhesive manufacturer's installation instructions for conditions, preparation, installation and curing time.
- As a guide, apply adhesive in ¾ inch thick by 3 inch diameter pads to the back of EnergyShield/EnergyShield CGF in 4 rows with a minimum of 7 pads per row. Space adhesive pads evenly across the board's length at no more than 16 inches on center. Space pads in rows no more than 16 inches on center and no

more than 3 inches from ends and edges. Immediately place against the wall surface before adhesive "skins." If adhesive "skins," remove and apply fresh material.

- Supplement EnergyShield/EnergyShield CGF adhesive attachment with 3–5 Rodenhouse Plasti Grip IV Flat PM Washer 1¾ inch diameter masonry fasteners or equivalent per board.

Layout for Masonry Wall

- Use maximum length EnergyShield/EnergyShield CGF to minimize joints.
- Stagger EnergyShield/EnergyShield CGF joints in horizontal rows from one course to the next a minimum of 6 inches so no two vertical joints meet.
- Cut or split EnergyShield/EnergyShield CGF to fit between masonry ties or purchase EnergyShield/EnergyShield CGF 16 or 24 inches wide.
- Overlap EnergyShield/EnergyShield CGF at corners. **See Figure A.**
- Fit EnergyShield/EnergyShield CGF tight at all joints, penetrations and features. **See Figure A.**
- Install masonry ties, exterior claddings or interior finishes per manufacturer's instructions and registered design professional's specification.

Interior Masonry Wall

- Secure EnergyShield/EnergyShield CGF to interior masonry walls or ceilings using cut nails, adhesive, a combination of both or with metal/wood furring. Follow preceding instructions for orientation, layout, spacing of fasteners, and adhesive.
- If an interior gypsum board thermal barrier is required, hold foam board in place until wood/metal furring is attached through foam to structure. See gypsum board manufacturer's instructions for attachment to furring.

IMAGE 3: MASONRY CAVITY WALL WITH EXTERIOR CONTINUOUS INSULATION

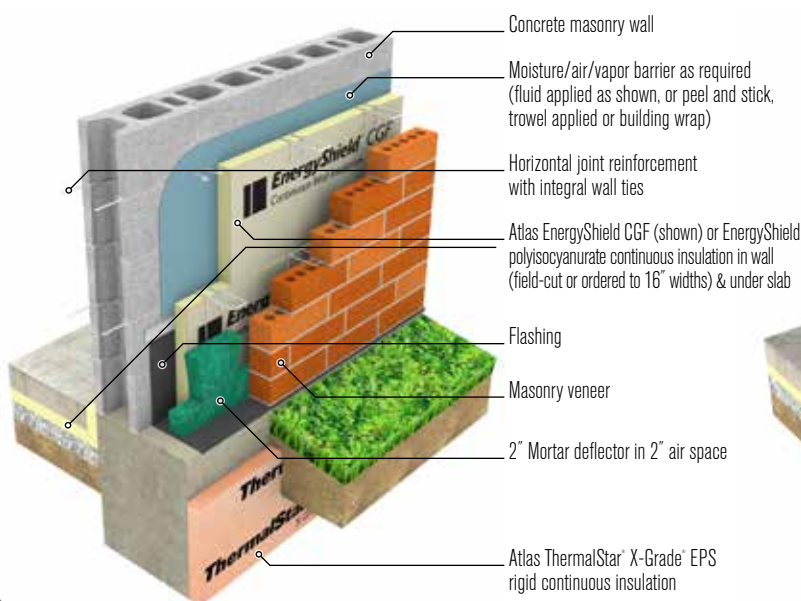
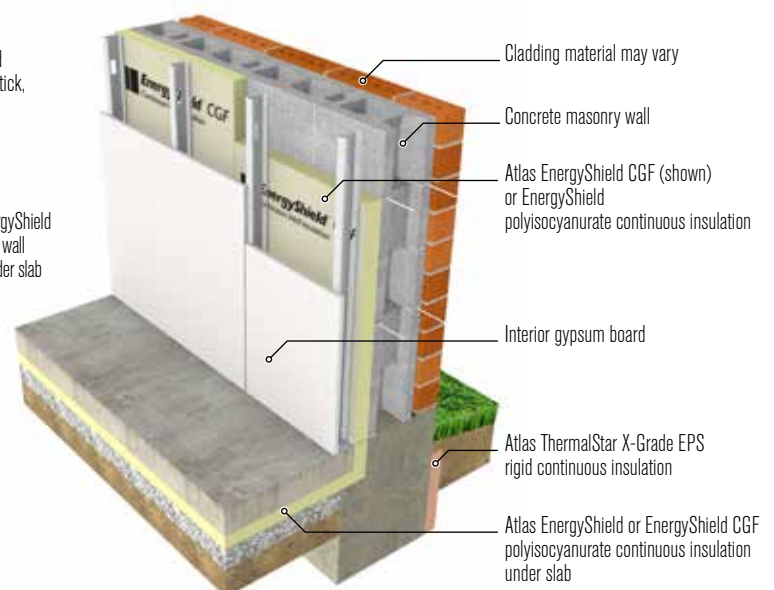

IMAGE 4: MASONRY CAVITY WALL WITH INTERIOR CONTINUOUS INSULATION



Follow all requirements in Application #1 or #2 then proceed as follows. **See Note #9.**

Brick Ties

- Consider using a threaded fastener style tie such as a Heckmann “Pos-i-Tie™” or Hohmann & Barnard “2-Seal™ Tie” or equivalent to reduce/eliminate the amount of horizontal EnergyShield®/EnergyShield® CGF joints created by brick ties which fasten directly to wood/gypsum sheathing or wood/metal stud framing such as corrugated sheet metal anchors or straps.

Flashing Tape

- Prepare facer at joints of EnergyShield/EnergyShield CGF per flashing tape manufacturer’s recommended instructions to insure a clean, dry, bondable surface. Use a sample of flashing tape to test adhesion prior to taping. Only prepare as much EnergyShield/EnergyShield CGF facer as you intend to tape in a day’s work.
- Apply minimum 4 inch wide flashing tape to joints of clean, dry EnergyShield/EnergyShield CGF. **See Note #6.**
- Use tape manufacturer’s recommended primer for improved adhesion.
- Use 3 inch “J” Roller with firm pressure to apply flashing tape centered over all joints, corners, fastener heads, and joints between dissimilar materials.
- Center flashing tape on vertical joints starting at lowest point and work upward in shingle fashion to ensure correct lap of intersecting tapes for water shed. **See Figure B.**
- “Terminate” horizontal flashing joints by adhering 2/3 of a self flashing 2–3 mil acrylic sheathing tape to EnergyShield/EnergyShield CGF and remaining 1/3 to the thicker flashing tape. **See Figure C and Note #7.**
- Cut pieces of flashing tape to cover every fastener head which is not already covered with flashing tape. Extend tape a minimum of 1 inch past fastener head in all directions.

Prepare Rough Openings

- Install pan flashing tape in rough opening prior to installation of window, door, feature and/or penetration.

- Pan flash the window/door sill with flashing tape to direct moisture to face of EnergyShield/EnergyShield CGF. Extend pan flashing tape no less than 6 inches up each side of the rough jam and no less than 1 ½ inches on to EnergyShield/EnergyShield CGF. **See Figure C.**

Windows and Doors

- Use flange-type windows and doors. **See Figure C.**
- Install window, door, feature, and penetration according to applicable code and/or window/door manufacturer instructions.
- Prior to setting window/door into rough opening, apply a continuous bead of sealant to the header and side window flanges only. **See Note #8.**
- After window has been properly installed in rough opening and fastened to structure, install window side flashing tapes. Completely cover the window side flanges extending a minimum of 2 inches on to the face of EnergyShield/EnergyShield CGF. **See Figure C.**
- Install window head flashing tape completely covering the window head flange and each window side flashing to extend onto EnergyShield/EnergyShield CGF no less than 2 inches past side window flashing tapes. **See Figure C.**
- “Terminate” header flashing tape with a self flashing 2–3 mil acrylic sheathing tape by adhering 2/3 sheathing tape to EnergyShield/EnergyShield CGF and remaining 1/3 to the thicker flashing tape. **See Figure C.**

Penetrations and Features

- Seal wall penetrations and features such as pipe, electrical access and dryer vents with compatible sheathing tape, flashing tape, caulk and/or sealant. **See Figure A.**
- “Terminate” uppermost horizontal flashing tape with a self flashing 2–3 mil acrylic sheathing tape by adhering 2/3 sheathing tape to EnergyShield/EnergyShield CGF and remaining 1/3 to the thicker flashing tape. **See Figure C.**

Note #6: There are several building tapes that may be used on EnergyShield/EnergyShield CGF. Consult tape manufacturer for specific compatibility. For the purposes of these instructions, flashing tape is typically opaque, commonly butyl but often acrylic, 10 mil thick or greater, whereas sheathing tape is thin, often translucent acrylic type, 2–3 mils thick. Following is a partial list of tapes with good adhesion and long term performance:

FLASHING TAPES

- Polyester metalized foil acrylic adhesive tapes (Protecto Super Stick Building Tape)
- Polypropylene backed, self-adhering tape with acrylic adhesive (such as 3M 8067, Dow WEATHERMATE™, DuPont™ Tyvek™ Tape)
- Butyl, self-adhering flashing tape (such as Protecto BT20XL Butyl™, BT25XL™, Protecto Form Flash 1™, Protecto Sill Pan Flashing™, Protecto Flex)

SHEATHING TAPES

- Polyethylene backed contractors sheathing tape (ThermalStar™ 007, IPG Sheathing Tape, 3M 8087)
- Aluminum foil coated, acrylic adhesive self-adhering tape (hard foil tapes, such as VentureTape™ 1519CW, IPG Cold Weather Aluminum Foil Tape)

Note #7: Leading building science experts often recommend thicker flashing tapes such as a 18 mil or greater flashing tape be “terminated” with a second application of thinner “self flashing” sheathing tape. The second application of a self flashing sheathing tape is a “belt and suspenders” approach that promotes water shed and prevents any moisture from getting behind header and other horizontal flashing tapes due to separation from “fish mouth” or poor adhesion. Thinner acrylic or butyl flashing tapes such as 10–15 mils tend to be self-flashing and may not need to be terminated with a sheathing tape to promote water shed.

Note #8: Common trade practice is to not apply sealant to bottom window flange so that any trapped moisture may escape the sill pan flashing and drain. For the same reason, the bottom window flange is also not typically flashed with tape. Consult window manufacturers’ instructions for specific flashing guidance when installing flange type windows over rigid EnergyShield/EnergyShield CGF.

Note #9: In applications where a WRB is installed over EnergyShield/EnergyShield CGF, follow WRB manufacturer’s instructions for attaching to/or through EnergyShield/EnergyShield CGF. In applications where WRB is installed behind EnergyShield/EnergyShield CGF, taping of EnergyShield/EnergyShield CGF seams is not recommended unless all other EnergyShield/EnergyShield CGF flashing details are followed. It is strongly advised that penetrations in the wall envelope such as windows, doorways, etc. are flashed to the exterior surface of EnergyShield/EnergyShield CGF, regardless of the presence of a separate WRB under EnergyShield/EnergyShield CGF layer.

IMAGE 5: LATERALLY BRACED WOOD FRAMING, CONTINUOUS INSULATION DETAILED AS A WRB AND DRAINAGE PLANE WITH TAPED JOINTS AND CLADDING FASTENED THROUGH FOAM TO STRUCTURE

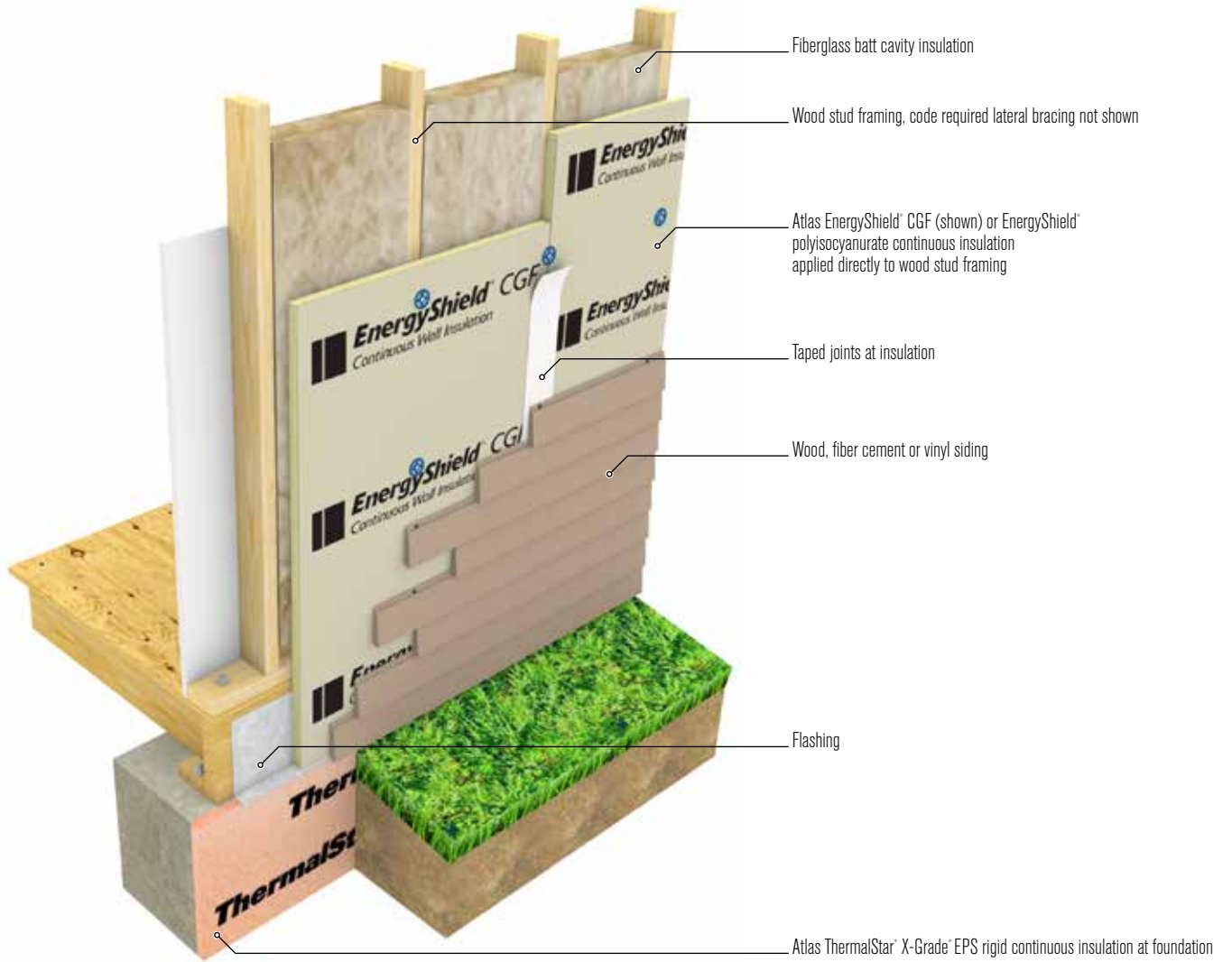

FIGURE A: FOAM BOARD AS CONTINUOUS INSULATION—CORNER PENETRATION CONDITIONS

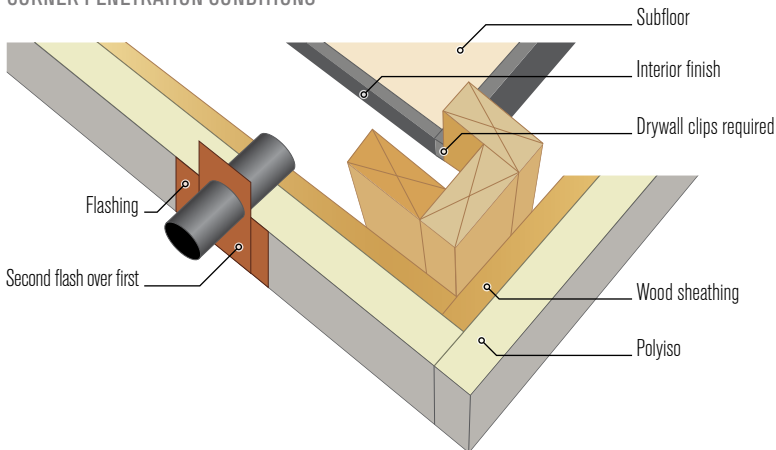

FIGURE B: FOAM BOARD AS CONTINUOUS INSULATION AND WRB OVER EXTERIOR WOOD SHEATHING FASTENED TO WOOD STUD FRAMING

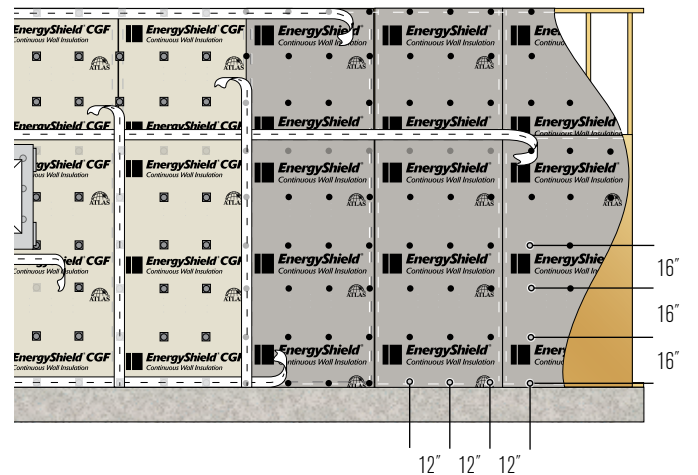
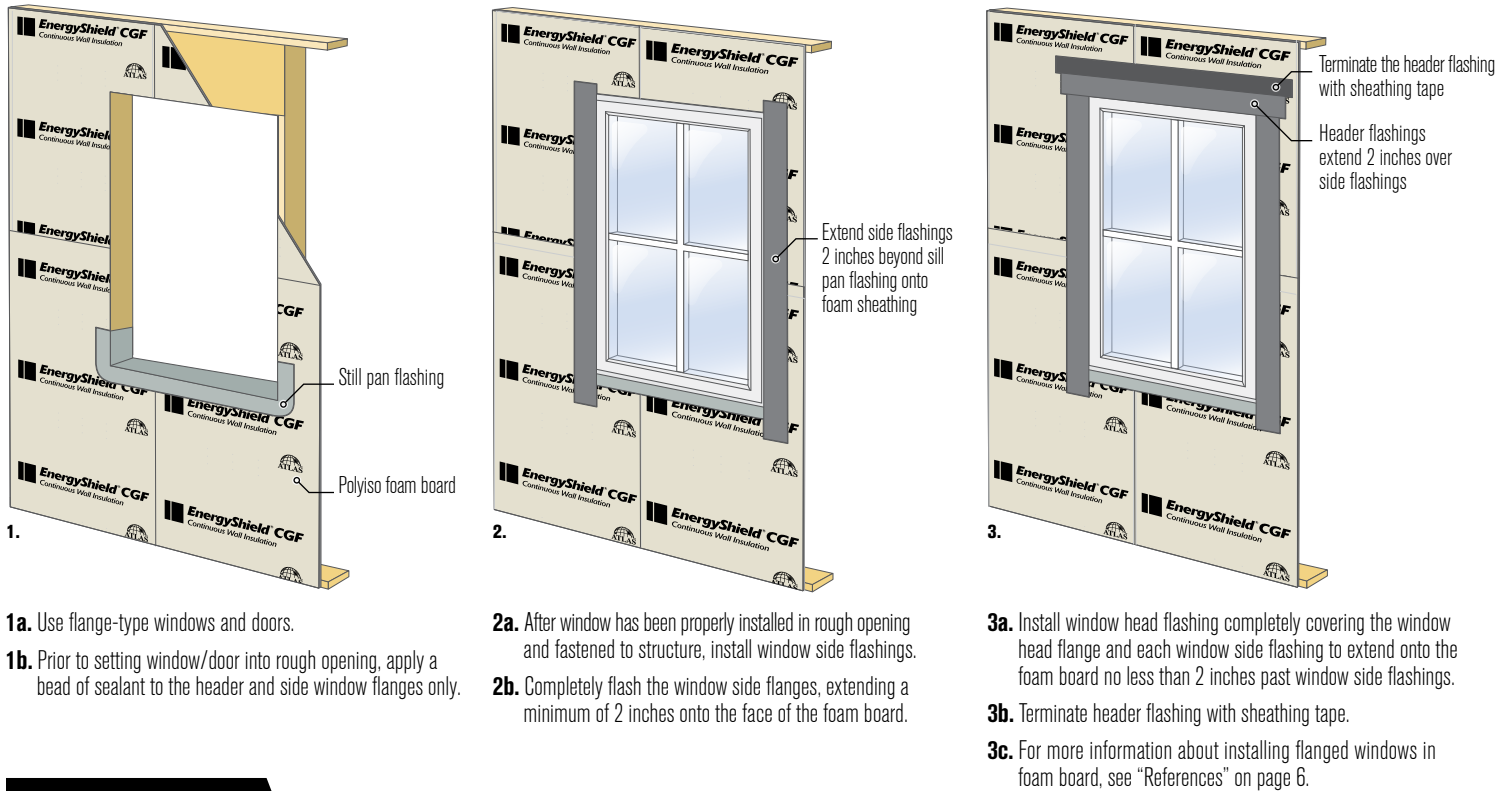

FIGURE C: FLANGED WINDOW INSTALLATION



APPLICATION #4 Installation of EnergyShield/EnergyShield CGF as under slab insulation.

Site Preparation

- Prepare suitable, drainable sub-grade, aggregate base or a combination of both.
- Cover installation area with protective membrane, minimum 10 mil polyethylene or equivalent.
- Overlap membrane joints by 24 inches and tape overlapping membrane joints with compatible tape.
- Extend membrane 6 feet on all sides of installation area.

Orientation

- Place first course of EnergyShield®/EnergyShield® CGF on membrane with printed side visible.

Layout

- Stagger joints of subsequent layers so that no two joints meet.

Joint Treatment

- Taping joints of initial, intermediate through final layers of foam board is recommended.

Membrane Cover

- Fold the 6 foot extensions of membrane over the last course of EnergyShield/EnergyShield CGF taping membrane ends to board facer.
- Apply a layer of 10 mil membrane over the last course of EnergyShield/EnergyShield CGF. Overlap membrane joints by 24 inches and tape overlapping membrane joints with compatible tape. Ensure membrane extends 6 inches past each edge and down each side. Secure to membrane with compatible tape or bury/back-fill with sub-grade or aggregate.

REFERENCES AND HELPFUL LINKS

- Technical Evaluation Report—TER #1205-05, Construction Details for the Use of Foam Plastic Insulating Sheathing (FPIS) in Light-frame Construction, SBC Research Institute, November 2012.
- ICC-ES Evaluation Report—ESR-1375. Reissued June 1, 2006. Revised September 2012.
- Installing Windows with Foam Sheathing on a Wood-frame Wall, Building Science Corporation/Building America U.S. Department of Energy, May 2005. NREL/SR-550-37583.
- Guidance on Taped Insulating Sheathing Drainage Planes: Final Report, Aaron Grin and Joseph W. Lstiburek, Building Science Corp., December 2012.
- Stuck On You, by Joseph W. Lstiburek, ASHRAE Journal, February 2013.
- Engineering Evaluation Report-Guide to Attaching Sheathing, Furring and/or Cladding through Continuous Foam Insulation to Wood Framing, Steel Framing, Concrete and CMU Substrates with TruFast SIP TP, SIP LD and Tru-Grip Fasteners, NTA, Inc., March 2012.
- ASTM E2112-07 Standard Practice for Installation of Exterior Windows, Doors and Skylights.

About Atlas

Atlas EnergyShield® products are designed and manufactured in the United States and Canada by Atlas Roofing Corporation for the ultimate utility in modern building envelopes. For 30-plus years, Atlas Roofing Corporation has served as an innovative, customer-oriented manufacturer of residential and commercial building materials. Atlas Roofing Corporation promotes 18 state-of-the-art manufacturing plants in North America, with eight dedicated to the Atlas EnergyShield product family.

Atlas International Polyiso Manufacturing

Coverage to support LEED and local building needs. Most U.S. and Canada locations can help earn LEED credit for local/regional materials, with <500 mile distance from project to production facility.

Why Atlas EnergyShield?

Leading performance compared with Extruded Polystyrene (XPS), Expanded Polystyrene (EPS) and rock wool. True CI with no thermal bridging.

Air and moisture barriers that are field proven, code compliant and material tested. Energy efficiency levels to match IECC and current building codes, as well as ASHRAE 90.1, required per LEED

Meets fire ratings and codes with low flame/smoke propagation, and a preferred response to fire over polystyrenes. It's stable, durable, non-corrosive and compatible with solvents.

Atlas EnergyShield is lightweight and easy to work with standard tools and available fasteners, and can be installed in almost any temperature.

Atlas provides a 15-year thermal performance warranty—for CI that lasts.

CONTACT US:



ATLAS ROOFING CORPORATION

Corporate Sales and Marketing

2000 RiverEdge Parkway, Suite 800, Atlanta, GA 30328

(770) 952-1442

wall.atlasrwi.com

Sales Offices:

1. Vancouver, BC

(855) 265-1476

Fax: (604) 395-8365

2. Toronto, ON

(888) 647-1476

Fax: (877) 909-4001



3. Denver, CO

(800) 288-1476

Fax: (303) 252-4417

4. East Moline, IL

(800) 677-1476

Fax: (866) 740-6019



5. Camp Hill, PA

(800) 288-1476

Fax: (717) 975-6957

6. Phoenix, AZ

(800) 477-1476

Fax: (602) 477-8897

7. Diboll, TX

(800) 766-1476

Fax: (936) 829-5363

8. LaGrange, GA

(800) 955-1476

Fax: (706) 882-4047

