



Boise Cascade®
ENGINEERED WOOD PRODUCTS

Specifier Guide | East
BCI® Joists and Versa-Lam® LVL



BCI JOIST AND VERSA-LAM LVL SPECIFIER GUIDE

BCI Joists 4500s, 5000s, 6000s, 6500s, 60s, 90s
Versa-Lam LVL 3100

bc.com/ewp

Reorder #MTP-E7000

What You're Made of Matters

The Boise Cascade Difference

When specifying products, choices matter. Finding the right balance of durability, cost-effectiveness, and proven performance is no small task. With Boise Cascade, you're choosing a product that's backed by our commitment to quality and reliability that has earned the trust of specifiers for over 60 years.

- ▶ EWP sourced from sustainably managed forests.
- ▶ Peace of mind with our limited lifetime warranty.
- ▶ Engineered and manufactured with reliability in mind.
- ▶ Dedicated product support from knowledgeable engineers.
- ▶ Boise Cascade® suite of software helps design, size, and analyze projects.

BCI® Joist Advantages

High-performance floors start with BCI® joists — providing strong, high-quality results along with the consistency and easy handling needed to get the job done efficiently.

- ▶ 20% stronger than comparably sized dimension lumber.
- ▶ Light weight reduces installation times.
- ▶ Greater strength = longer span capability.
- ▶ Pre-stamped knockouts and allowances for on-site hole cutting.
- ▶ Flanges made with Versa-Lam® LVL.

Versa-Lam® LVL Advantages

Get industry-leading overall value without sacrificing strength. Versa-Lam LVL beams and headers resist twisting, shrinking, and splitting — creating flatter, quieter floors that keep customers happy.

- ▶ Longer spans while remaining stable.
- ▶ No camber for flat floors and walls.
- ▶ Wide range of applications.
- ▶ Best-in-class bending strength and stiffness.
- ▶ Depths designed to match BCI® and AJS® joists.

TABLE OF CONTENTS

Boise Cascade Chain-Of-Custody Certifications	2
Product Storage and Handling	2
BCI JOISTS	3
Product Profiles	3
Architectural Specifications	3
Residential Floor Span Tables	4
One-Hour Fire Resistance Assembly	4
Floor Framing Details	5-6
Hole Location and Sizing	7
Large Rectangular Holes	7
Cantilevers Bearing and Non-Bearing	8-9
Web Stiffener Requirements	9
Floor Load Tables	10-12
Roof Framing Details	13-14
Roof Span Tables	15-8
Roof Load Tables	19-23
BCI Joist Design Properties	24
Closest Allowable Nail Spacing	24
Rim Board Details and Properties	25
Versa-Lam LVL Beams	26
Product Profiles and Architectural Specifications	26
Versa-Lam LVL Allowable Holes	26
Versa-Lam LVL Beam Details	27
Versa-Lam LVL Beam Multiple Member Connections	27
Versa-Lam LVL Beam Floor Load Table	28
Versa-Lam LVL Beam Roof Load Tables	29-30
Versa-Lam LVL Beam Allowable Nailing	31
Versa-Lam LVL Beam Design and Allowable Stress Values	31
Versa-Lam LVL Columns and Studs	32
Framing Connectors	34-35

Boise Cascade Chain-Of-Custody Certifications

Boise Cascade Engineered Wood Products (EWP) has a proven track record of providing quality wood products and a nationwide building materials distribution network for our customers, helping them to enhance their own businesses.

Boise Cascade engineered wood products build better homes with stronger, stiffer floors using only wood purchased in compliance with a number of green building programs.

Take a moment to view our sustainability certification at bc.com/certification-wp/ or go to bc.com/sustainability for more information.

Boise Cascade engineered wood products throughout North America can be ordered FSC® Chain-of-Custody (COC) certified, enabling homebuilders to achieve LEED® points residential and commercial green building programs including LEED for Homes and LEED for New Construction.

Boise Cascade engineered wood products are available as PEFC® Chain-of-Custody certified, SFI® Chain-of-Custody certified and SFI® Fiber-Sourcing certified, as well as NAHB Research Center Green Approved, enabling homebuilders to also obtain green building points through the Green Building Standards.

Code Evaluation Report: ICC-ES®/APA® ESR-1336 (IBC®, IRC®)

Protect product from rain and sun.

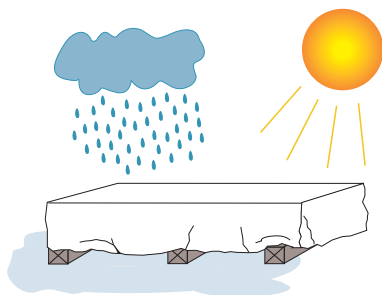

Keep product level and off the ground.

PRODUCT STORAGE AND HANDLING

- ▶ BCI® and AJS® joists and Versa-Lam® LVL
 - must be stored, installed and used in accordance with the Boise Cascade EWP Installation Guide, building codes and, to the extent not inconsistent with the Boise Cascade EWP Installation Guide, usual and customary building practices and standards.
 - must be wrapped, covered, and stored off of the ground on stickers at all times prior to installation.
 - are intended only for applications that ensure no exposure to weather or the elements and an environment that is free from moisture from any source, or any pest, organism or substance which degrades or damages wood or glue bonds.
- ▶ Unload products carefully and support to reduce excessive bowing. Use forklifts and cranes carefully to avoid damaging product
- ▶ Do not use a visibly damaged product. Contact your local Boise Cascade representative for assistance.
- ▶ Failure to correctly store, use, or install BCI® and AJS® joists or Versa-Lam® LVL in accordance with the Boise Cascade EWP Installation Guide will void the limited warranty.

BCI JOISTS



Product Profiles

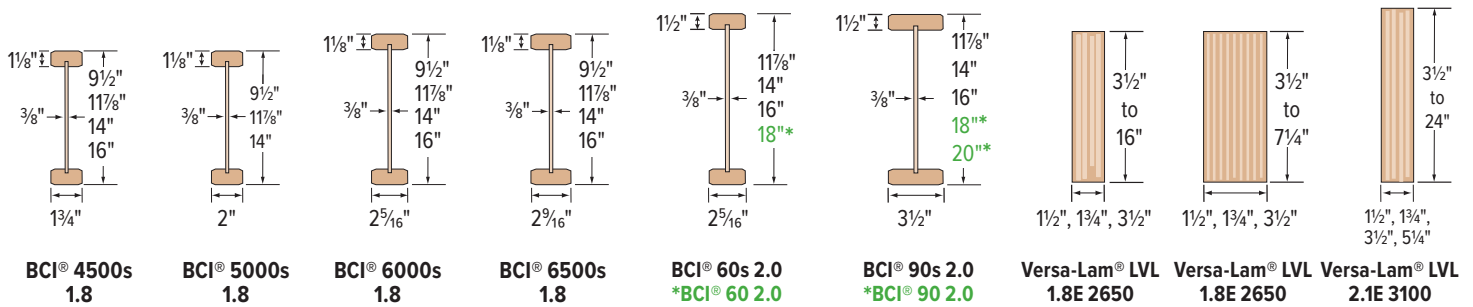

*Deep depth BCI® 60 and 90 joists are special order.

Some products may not be available in all markets; Contact your Boise Cascade EWP representative for availability.

BCI® joists and Versa-Lam® LVL products shall be installed in dry-use applications only, per their respective ICC-ES/APA ESR evaluation reports.

Architectural Specifications

Scope — This work includes the complete furnishing and installation of all BCI® joists as shown on the drawings, herein specified and necessary to complete the work.

Materials — BCI® joists shall be manufactured by Boise Cascade Engineered Wood Products with oriented strand board webs, Versa-Lam® laminated veneer lumber flanges, and waterproof, structural adhesives.

Joist webs shall be rated Structural I Exposure 1 by an agency listed by a model code evaluation service. Strands on the face layers of the web panels shall be oriented vertically in the joist. The web panels shall be glued together to form a continuous web member. The web panels shall be machined to fit into a groove in the center of the wide face of the flange members to form a pressed glue joint at that junction.

Design — The BCI® joists shall be sized and detailed to fit the dimensions and loads indicated on the plans. All designs shall be in accordance with allowable values and section properties developed in accordance with ASTM D5055, and listed in the governing code evaluation service's report.

Drawing — Additional drawings showing layout and detail necessary for determining fit and placement in the building are (are not) to be provided by the supplier.

Fabrication — The BCI® joists and section properties shall be manufactured in a plant evaluated for fabrication by the governing code evaluation service and under the supervision of a third-party inspection agency listed by the corresponding evaluation service.

Storage and Installation — The BCI® joists, if stored prior to erection, shall be stored in a vertical and level position and protected from the weather. They shall be handled with care so they are not damaged.

The BCI® joists are to be installed in accordance with the plans and the Boise Cascade Engineered Wood Products Installation Guide. Temporary construction loads which cause stresses beyond design limits are not permitted. Erection bracing shall be provided to keep the BCI® joists straight and plumb as required and to assure adequate lateral support for the individual BCI® joists and the entire system until the sheathing material has been applied.

Codes — The BCI® joists shall be evaluated by a model code evaluation service.

Residential Floor Span Tables

About Floor Performance

Homeowner's expectations and opinions vary greatly due to the subjective nature of rating a new floor. Communication with the ultimate end user to determine their expectation is critical. **Vibration** is usually the cause of most complaints. Installing lateral bridging may help; however, squeaks may occur if not installed properly. Spacing the joists closer together does little to affect the perception of the floor's performance. The most common methods used to increase the performance and reduce vibration of wood floor systems is to **increase the joist depth, limit joist**

deflections, glue and screw a thicker, tongue-and-groove subfloor, install the joists vertically plumb with level-bearing supports, and install a direct-attached ceiling to the bottom flanges of the joists.

The floor span tables listed below offer three very different performance options, based on performance requirements of the homeowner.

Joist Depth	BCI® Joist Series	★★★ THREE STAR ★★★					★★★★ FOUR STAR ★★★★★					CAUTION	★ MINIMUM STIFFNESS ALLOWED BY CODE ★	CAUTION		
		Live Load deflection limited to L/480: The common industry and design community standard for residential floor joists, 33% stiffer than L/360 code minimum. However, floor performance may still be an issue in certain applications, especially with 9½" and 11⅞" deep joists without a direct-attached ceiling.					Live Load deflection limited to L/960+: In addition to providing a floor that is 100% stiffer than the three star floor, field experience has been incorporated into the values to provide a floor with a premium performance level for the more discriminating homeowner.					Live Load deflection limited to L/360: Floors that meet the minimum building code L/360 criteria are structurally sound to carry the specified loads; however, there is a much higher risk of floor performance issues. This table should only be used for applications where floor performance is not a concern.				
		12" o.c.	16" o.c.	19.2" o.c.	24" o.c.	32" o.c.	12" o.c.	16" o.c.	19.2" o.c.	24" o.c.	32" o.c.	12" o.c.	16" o.c.	19.2" o.c.	24" o.c.	32" o.c.
9½"	4500s	16'-11"	15'-6"	14'-8"	13'-7"	11'-9"	11'-6"	11'-6"	10'-0"	10'-0"	9'-7"	18'-9"	16'-8"	15'-3"	13'-7"	11'-9"
	5000s	17'-6"	16'-0"	15'-2"	14'-1"	12'-5"	11'-6"	11'-6"	10'-0"	10'-0"	9'-11"	19'-4"	17'-9"	16'-4"	14'-7"	12'-5"
	6000s	18'-2"	16'-8"	15'-8"	14'-8"	13'-4"	11'-6"	11'-6"	10'-0"	10'-0"	10'-0"	20'-2"	18'-5"	17'-5"	15'-9"	13'-8"
	6500s	18'-8"	17'-1"	16'-1"	15'-0"	13'-8"	11'-6"	11'-6"	10'-0"	10'-0"	10'-0"	20'-8"	18'-11"	17'-10"	16'-7"	14'-3"
11⅞"	4500s	20'-0"	18'-4"	17'-3"	15'-5"	13'-4"	15'-6"	14'-3"	13'-5"	12'-6"	11'-4"	21'-10"	18'-11"	17'-3"	15'-5"	13'-4"
	5000s	20'-9"	19'-0"	17'-11"	16'-7"	13'-4"	15'-6"	14'-9"	13'-11"	12'-11"	11'-9"	23'-0"	20'-4"	18'-6"	16'-7"	13'-4"
	6000s	21'-7"	19'-8"	18'-7"	17'-4"	14'-10"	15'-6"	15'-4"	14'-5"	13'-5"	12'-1"	23'-10"	21'-10"	20'-0"	17'-11"	14'-10"
	6500s	22'-2"	20'-3"	19'-2"	17'-10"	14'-10"	16'-0"	15'-10"	14'-11"	13'-10"	12'-7"	24'-6"	22'-5"	21'-1"	18'-10"	14'-10"
	90s	26'-7"	24'-3"	22'-10"	21'-3"	19'-4"	19'-0"	18'-10"	17'-8"	16'-5"	14'-10"	29'-5"	26'-10"	25'-3"	23'-6"	19'-4"
14"	4500s	22'-9"	20'-7"	18'-9"	16'-9"	13'-11"	17'-10"	16'-3"	15'-4"	14'-3"	13'-0"	23'-10"	20'-7"	18'-9"	16'-9"	13'-11"
	5000s	23'-7"	21'-7"	20'-2"	18'-0"	13'-11"	18'-6"	16'-10"	15'-11"	14'-9"	13'-5"	25'-7"	22'-1"	20'-2"	18'-0"	13'-11"
	6000s	24'-6"	22'-5"	21'-2"	19'-6"	15'-5"	19'-2"	17'-6"	16'-6"	15'-4"	13'-11"	27'-1"	23'-11"	21'-10"	19'-6"	15'-5"
	6500s	25'-2"	23'-0"	21'-8"	20'-2"	15'-5"	19'-8"	17'-11"	16'-11"	15'-8"	14'-3"	27'-9"	25'-2"	22'-11"	20'-6"	15'-5"
	60s	26'-9"	24'-5"	23'-0"	21'-5"	16'-4"	20'-11"	19'-0"	17'-11"	16'-7"	15'-1"	29'-7"	27'-0"	25'-6"	21'-10"	16'-4"
	90s	30'-1"	27'-5"	25'-10"	24'-0"	19'-6"	23'-6"	21'-4"	20'-0"	18'-6"	16'-9"	33'-3"	30'-4"	28'-7"	26'-0"	19'-6"
16"	4500s	25'-2"	22'-0"	20'-1"	17'-11"	14'-1"	19'-9"	18'-0"	17'-0"	15'-10"	14'-1"	25'-5"	22'-0"	20'-1"	17'-11"	14'-1"
	6000s	27'-0"	24'-9"	23'-4"	20'-10"	15'-9"	21'-2"	19'-4"	18'-2"	16'-11"	15'-4"	29'-6"	25'-6"	23'-4"	20'-10"	15'-9"
	6500s	27'-9"	25'-4"	23'-11"	21'-1"	15'-9"	21'-9"	19'-9"	18'-8"	17'-4"	15'-8"	30'-8"	26'-11"	24'-6"	21'-1"	15'-9"
	60s	29'-7"	27'-0"	25'-6"	21'-10"	16'-4"	23'-2"	21'-1"	19'-10"	18'-5"	16'-4"	32'-8"	29'-10"	27'-4"	21'-10"	16'-4"
	90s	33'-4"	30'-4"	28'-7"	26'-2"	19'-7"	26'-0"	23'-7"	22'-2"	20'-6"	18'-7"	36'-10"	33'-7"	31'-8"	26'-2"	19'-7"

NOTES

- ▶ Tables are based on
 - residential floor load of 40 psf live load and 10 psf dead load (12 psf dead load for 90s 2.0 joists).
 - 23/32" minimum plywood/OSB rated sheathing glued and nailed to joists for composite action (joists spaced at 32" o.c. require sheathing rated for such spacing, such as 5/8" plywood/OSB).
 - the most restrictive of simple or multiple span applications. Analyze multiple span joists with BC Calc® sizing software if the length of any span is less than half the length of an adjacent span.
 - maximum allowable clear distance between supports.
 - minimum bearing lengths without web stiffeners for joist depths of 16" and less.

- ▶ Floor tile will increase dead load and may require specific deflection limits, contact Boise Cascade EWP Engineering for further information.
- ▶ This table was designed to apply to a broad range of applications. It may be possible to exceed the limitations of this table by analyzing a specific application with the BC Calc® sizing software.

Gold-shaded values may not satisfy the requirements of the North Carolina State Building Code. Refer to the THREE STAR table when spans exceed 20 feet.

One-Hour Fire Resistance Assembly (ICC-ES/APA ESR-1336)

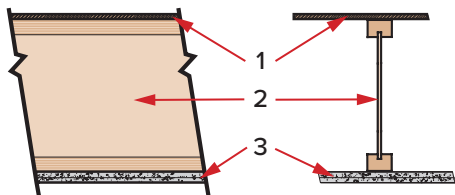

Fire Assembly Components

- (1) Min. 23/32" thick tongue and groove sheathing (exterior glue), installed with long edge perpendicular to joist length, staggered one joist spacing with adjacent sheets, and glued to joists with construction adhesive.
- (2) BCI® joists at 24" o.c. or less.
- (3) Two layers 5/8" Type X or two layers 1/2" Type C gypsum board, installed per Figures 2 or 3 of ICC-ES®/APA® ESR-1336.

Sound Assembly Components (when constructed with resilient channels)

- Add carpet and pad to fire assembly STC=54 IIC=68 or
- Add 3½" glass fiber insulation to fire assembly STC=55 IIC=46 or
- Add an additional layer of minimum 5/8" sheathing and 9½" glass fiber insulation to fire assembly STC=61 IIC=50

See the US version of the *Boise Cascade Fire Design and Installation Guide* for specific assembly information and other fire resistance assemblies and details.

Floor Framing

The illustration below is showing several suggested applications for the Boise Cascade EWP products. It is not intended to show an actual house under construction.

NO MIDSPAN BRIDGING IS REQUIRED FOR BCI® JOISTS

FOR INSTALLATION STABILITY:

Temporary strut lines (1x4 min.) 8' o.c. max.
Fasten at each joist with two 2½" (8d) nails minimum.

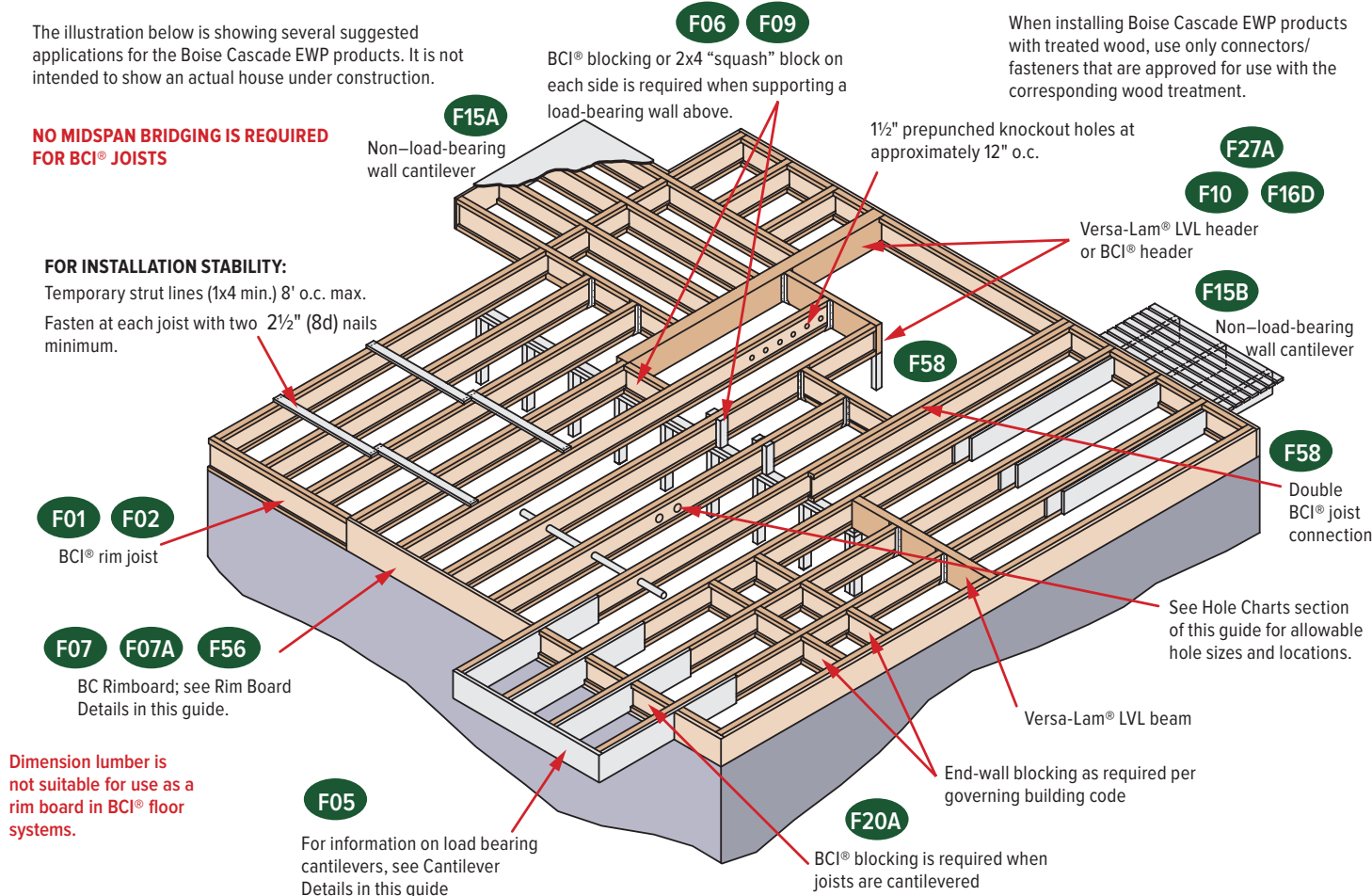

Dimension lumber is not suitable for use as a rim board in BCI® floor systems.

SAFETY WARNING

DO NOT allow workers on BCI® joists until all hangers, BCI® rim joists, rim boards, BCI® blocking panels, x-bracing and temporary 1x4 strut lines are installed as specified below. Serious accidents can result from insufficient attention to proper bracing during construction. Accidents can be avoided under normal conditions by following these guidelines:

- ▶ Build a braced end wall at the end of the bay, or permanently install the first eight feet of BCI® joists and the first course of sheathing. As an alternate, temporary sheathing may be nailed to the first four feet of BCI® joists at the end of the bay.
- ▶ All rim joists, rim boards, x-bracing, blocking panels and hangers must be completely installed and properly nailed as each BCI® joist is set.
- ▶ Install temporary 1x4 strut lines at 8' on-center or closer as additional BCI® joists are set. Nail the strut lines to the sheathed area or braced end wall, and to each BCI® joist with two 2½" (8d) nails.
- ▶ The ends of cantilevers must be temporarily secured by strut lines on both the top and bottom flanges.
- ▶ Straighten the BCI® joists to within ½" of true alignment before attaching strut lines and sheathing.
- ▶ Remove the temporary strut lines only as required to install the permanent sheathing.
- ▶ Failure to install temporary bracing may result in sideways buckling or roll-over under light construction loads.
- ▶ Do not stack construction materials (sheathing, drywall, etc.) in the middle of BCI® joist spans. Contact Boise Cascade EWP Engineering for proper storage and shoring information.

Nailing Requirements

- ▶ **BCI® rim joist, rim board or closure panel to BCI® joist:**
 - **Rim or closure panel:** Two nails, one each in the top and bottom flange. For rim 1-1/2" thick or less, use 8d x 2½" nails; 1¾" thick rim, use 10d x 3" box nails.
 - **BCI® 4500s/5000s rim joist:** Two 10d box nails, one each in the top and bottom flange.
 - **BCI® 6000s/60s rim joist:** Two 16d box nails, one each in the top and bottom flange.
 - **BCI® 6500s/90s rim joist:** Toe-nail top flange to rim joist with two 10d box nails, one each side of flange.
- ▶ **BCI® rim joist, rim board or BCI® blocking panel to support:**
 - Min. 8d nails at 6" o.c. per IRC®.
 - Connect per design professional of record's specification for shear transfer.
- ▶ **BCI® joist to support:**
 - Two 8d nails, one on each side of the web, placed 1½" minimum from the end of the BCI® joist to limit splitting.
- ▶ **Sheathing to BCI® joist:**
 - Prescriptive nailing for residential floor sheathing requires 8d common nails at 6" o.c. at edges and 12" o.c. in the field (IRC® Table R602.3(1)).
 - See Closest Allowable Nail Spacing limits on page 24 for floor diaphragm nailing specified at closer spacing than IRC®.
 - For full lateral stability, maximum nail spacing for bracing is 18" for BCI® 4500s and 5000s, and 24" for larger BCI® joist series.
 - 14 gauge staples may be substituted for 8d nails if the staples penetrate at least 1" into the joist.
 - Wood screws may be acceptable, contact local building official and/or Boise Cascade EWP Engineering for more information.

BCI® Joist Slope Cut Reinforcement

Detail below restores the original allowable shear/ reaction value to cut end of BCI® joist. BCI® joists shall not be used as a collar or rafter tension tie.

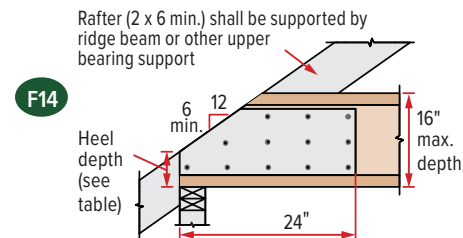

2x blocking required at bearing (not shown for clarity). 2½" min. plywood/OSB-rated sheathing as reinforcement. Install reinforcement with face grain horizontal. Install on both sides of the joist, tight to bottom flange. Leave minimum ¼" gap between reinforcement and bottom of top flange. Apply construction adhesive to contact surfaces and fasten with 3 rows of min. 10d box nails at 6" o.c. Alternate nailing from each side and clinch.

End Wall	Minimum Heel Depth					
	Roof Pitch					
Bearing	6:12	7:12	8:12	9:12	10:12	12:12
2 x 4	4⅜"	4⅝"	4¾"	4¾"	4¾"	4¾"
2 x 6	3⅝"	3⅞"	2⅝"	2¾"	2⅞"	2¼"

PROTECT BCI® JOISTS FROM THE WEATHER

BCI® joists are intended only for applications that provide permanent protection from the weather. Product bundles should be covered and stored off of the ground on stickers. Also see **PRODUCT STORAGE AND HANDLING** on page 2.

Floor Framing Details

End Bearing Details

F07

Dimension lumber is not suitable for use as rim board with BCI® joists.

Rim board: Nail to BCI® joists with 2½" (8d) nail into each flange.

F07A

Dimension lumber is not suitable for use as rim board with BCI® joists.

Blocking may be required perpendicular to wall, consult design professional of record and/or local building official.

F01

BCI® joist blocking

F02

BCI® rim joist

BCI® rim joist requires 2x6 wall for minimum bearing

F27A

Top flange or face mount joist hanger

Versa-Lam® LVL

F52

One 8d nail each side at bearing

½" minimum bearing length

To limit splitting flange, start nails at least ½" from end. Nails may need to be driven at an angle to limit splitting of bearing plate.

F08

Use solid blocking under all posts above for support to the bearing plate.

F03

Boise Cascade® rimboard

BCI® floor joist must be designed to carry wall above when not stacked over wall below.

Blocking required underneath braced wall panels and shear walls. Consult design profession of record.

Intermediate Bearing Details

F06 For load bearing wall above (stacked over wall below)

BCI® joist blocking

Per IRC, blocking may be required at intermediate bearing for floor diaphragm in high seismic areas; consult local building official.

F09

Load bearing wall above (stacked over wall below)

2x block

F10

Backer block (minimum 12" wide). Nail with ten 10d nails.

Joist hanger

Filler block. Nail with ten 10d nails.

A backer block is required where the top flange hanger load exceeds 250 lbs. All face mount hangers require backer blocks on both sides of the supporting joist's web. For top flange hangers install tight to top flange. For face mount hangers, install tight to the bottom flange.

F58 **Double BCI® Joist Connection**

Filler block (if required).

Web filler nailing

- ▶ Filler block not required when all loads are top loaded and evenly applied to each ply (except BCI® 90 joist).
- ▶ Side loads or uneven top loads require filler block.
- ▶ Fasten floor sheathing to each ply per diaphragm nailing schedule.

See BC Tech Note 1J-13 for more information on nailing and filler block requirements.

Size	Joist Spacing			
	12"	16"	19.2"	24"
2x4	4,463	3,347	2,789	2,231
2x6	7,013	5,259	4,383	3,506

▶ Squash blocks are to be in full contact with upper floor and lower wall plate.

▶ Capacities shown are for double squash blocks at each joist, SPF or better.

F05

Sheathing or rim board closure

BCI® joist blocking required for cantilever

For load bearing cantilever, see page 9. Uplift on backspan shall be considered in all cantilever designs.

Lateral Support

- ▶ BCI® joists shall be laterally supported at the ends with hangers, rim board, BCI® rim joists or blocking panels. BCI® blocking panels or rim board are required at cantilever supports.
- ▶ Per IRC®, blocking may be required at intermediate bearings for floor diaphragm. In high seismic areas, consult local building official.

Minimum Bearing Length For BCI® Joists

- ▶ 1½" is required at end supports. 3½" is required at cantilever and intermediate supports.
- ▶ Longer bearing lengths allow higher reaction values. Refer to the building code evaluation report or the BC Calc® software.

Web Stiffeners

- ▶ See **Web Stiffener Requirements** on page 9.

Backer and Filler Block Dimensions

Series	Backer Block Thickness	Filler Block Thickness
4500s	5/8" or 3/4" wood panels	Two 5/8" wood panels or 2 x _
5000s	3/4" or 7/8" wood panels	Two 3/4" wood panels or 2 x _
6000s	1 1/8" or two 1/2" wood panels	2 x _ + 7/16" or 1/2" wood panel
6500s	1 1/8" or two 5/8" wood panels	2 x _ + 5/8" or 3/4" wood panel
60s	1 1/8" or two 1/2" wood panels	2 x _ + 7/16" or 1/2" wood panel
90s	2 x _ lumber	Double 2 x _ lumber

▶ Cut backer and filler blocks to a maximum depth equal to the web depth minus ¼" to avoid a forced fit.

BCI® Rim Joists and Blocking

Depth	Series	Vertical Load Capacity (PLF)	
		No W.S. ⁽¹⁾	W.S. ⁽²⁾
9½"	4500s, 5000s, 6000s, 6500s	2,300	N/A
	4500s, 5000s, 6000s, 6500s	2,150	N/A
11 7/8"	60s, 90s	2,500	N/A
	4500s, 5000s, 6000s, 6500s	2,000	N/A
14"	60s, 90s	2,400	N/A
	4500s, 6000s, 6500s	1,900	2,500
16"	60s, 90s	2,300	2,700

(1) No web stiffeners required.

(2) Web stiffeners required at each end of blocking panel, values not applicable to rim joists.

N/A: Not applicable

Hole Location and Sizing

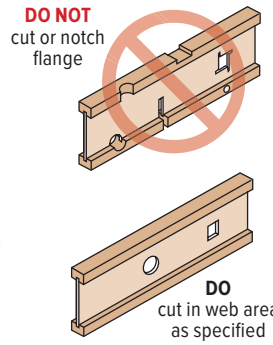
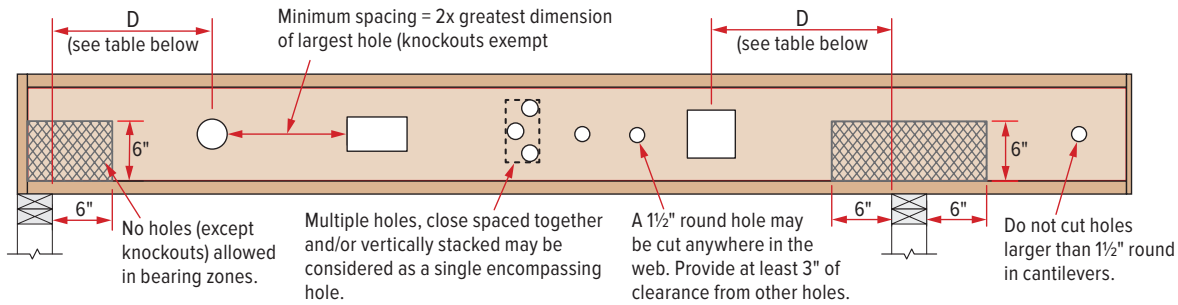

BCI® joists are manufactured with 1/2" round perforated knockouts in the web at approximately 12" o.c. Minimum distance from support, listed in table below, is required for all holes greater than 1/2".

Minimum Distance (D) From Any Support To The Centerline Of The Hole																
Round Hole Diameter		2"	3"	4"	5"	6"	6 1/2"	7"	8"	8 3/8"	9"	10"	11"	12"	13"	
Rectangular Hole Side		-	-	-	3"	5"	6"	7"	-	-	-	-	-	-	-	
Any 9 1/2" Joist	Span	8'	1'-0"	1'-1"	1'-5"	2'-1"	2'-9"	3'-1"	3'-5"							
		12'	1'-0"	1'-2"	2'-2"	3'-2"	4'-2"	4'-8"	5'-2"							
		16'	1'-0"	1'-7"	2'-11"	4'-3"	5'-7"	6'-3"	6'-11"							
Round Hole Diameter		2"	3"	4"	5"	6"	6 1/2"	7"	8"	8 3/8"	9"	10"	11"	12"	13"	
Rectangular Hole Side		-	-	-	2"	3"	4"	5"	7"	8"	-	-	-	-	-	
Any 11 7/8" Joist	Span	8'	1'-0"	1'-1"	1'-5"	1'-10"	2'-4"	2'-7"	2'-10"	3'-4"	3'-9"					
		12'	1'-0"	1'-4"	2'-1"	2'-10"	3'-7"	3'-11"	4'-3"	5'-0"	5'-8"					
		16'	1'-0"	1'-10"	2'-10"	3'-9"	4'-9"	5'-3"	5'-9"	6'-9"	7'-7"					
		20'	1'-1"	2'-3"	3'-6"	4'-9"	5'-11"	6'-7"	7'-2"	8'-5"	9'-6"					
Round Hole Diameter		2"	3"	4"	5"	6"	6 1/2"	7"	8"	8 3/8"	9"	10"	11"	12"	13"	
Rectangular Hole Side		-	-	-	-	2"	3"	3"	5"	6"	6"	8"	9"	-	-	
Any 14" Joist	Span	8'	1'-0"	1'-1"	1'-2"	1'-3"	1'-8"	1'-10"	2'-1"	2'-6"	2'-10"	2'-11"	3'-4"	3'-8"		
		12'	1'-0"	1'-1"	1'-3"	1'-10"	2'-6"	2'-10"	3'-1"	3'-9"	4'-3"	4'-4"	5'-0"	5'-7"		
		16'	1'-0"	1'-1"	1'-8"	2'-6"	3'-4"	3'-9"	4'-2"	5'-0"	5'-8"	5'-10"	6'-8"	7'-5"		
		20'	1'-0"	1'-1"	2'-1"	3'-2"	4'-2"	4'-8"	5'-2"	6'-3"	7'-2"	7'-3"	8'-4"	9'-4"		
		24'	1'-0"	1'-4"	2'-6"	3'-9"	5'-0"	5'-8"	6'-3"	7'-6"	8'-7"	8'-9"	10'-0"	11'-2"		
Round Hole Diameter		2"	3"	4"	5"	6"	6 1/2"	7"	8"	8 3/8"	9"	10"	11"	12"	13"	
Rectangular Hole Side		-	-	-	-	-	2"	3"	5"	5"	6"	8"	9"	10"		
Any 16" Joist	Span	8'	1'-0"	1'-1"	1'-2"	1'-2"	1'-3"	1'-3"	1'-3"	1'-7"	1'-11"	2'-0"	2'-5"	2'-9"	3'-2"	3'-7"
		12'	1'-0"	1'-1"	1'-2"	1'-2"	1'-3"	1'-6"	1'-10"	2'-5"	2'-11"	3'-0"	3'-7"	4'-2"	4'-9"	5'-4"
		16'	1'-0"	1'-1"	1'-2"	1'-2"	1'-8"	2'-1"	2'-6"	3'-3"	3'-11"	4'-0"	4'-10"	5'-7"	6'-4"	7'-2"
		20'	1'-0"	1'-1"	1'-2"	1'-2"	2'-1"	2'-7"	3'-1"	4'-1"	4'-11"	5'-1"	6'-0"	7'-0"	8'-0"	8'-11"
		24'	1'-0"	1'-1"	1'-2"	1'-4"	2'-6"	3'-1"	3'-9"	4'-11"	5'-11"	6'-1"	7'-3"	8'-5"	9'-7"	10'-9"

HOW TO USE THIS TABLE

- Select a table row based on joist depth and the actual joist span rounded up to the nearest span shown in the table.
- Scan across the row to the column for the appropriate round hole diameter or rectangular hole side. Use the longest side of a rectangular hole.
- The table value shown is the closest that the centerline of the hole may be to the edge or face of the nearest support.

NOTES

- ▶ **DO NOT** cut joist flanges.
- ▶ Holes apply to either single or multiple joists in repetitive member conditions.
- ▶ For multiple holes, the amount of horizontal uncut web between holes must equal at least twice the diameter (or longest side) of the largest hole.
- ▶ Table assumes one hole per horizontal location. Holes located above or below another should be considered as a single hole that encompasses all the holes.
- ▶ 1/2" round knockouts in the web may be removed by using a short piece of metal pipe and hammer.
- ▶ Single holes may be positioned anywhere vertically in the web, provided they do not extend into either flange.
- ▶ This table was designed to apply *only* to the design conditions covered by tables elsewhere in this publication (maximum uniform PLF load).
- ▶ Use the BC Calc® software to check other hole sizes or holes in other design conditions. It may be possible to exceed the limitations of this table by analyzing a specific application with the BC Calc® software.

Large Rectangular Holes

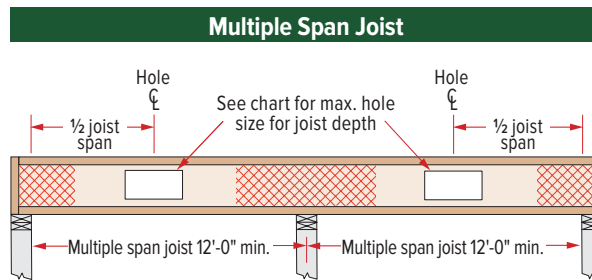
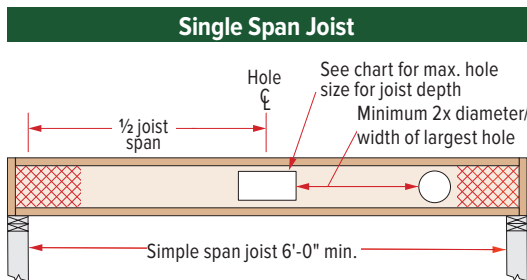

Maximum Hole Size

Joist Depth	Simple Span	Multiple Span
9 1/2"	6" x 14"	6" x 12"
11 7/8"	7" x 16" 8" x 15"	8" x 12"
14"	9" x 16" 10" x 15"	8" x 15"
16"	9" x 18" 11" x 16"	10" x 14"

- ▶ Hole sizes in table below are based on maximum uniform load of 40 psf live load and 10 psf dead load, at maximum spacing of 24" on-center.
- ▶ Additional holes may be cut in the web provided they meet the specifications shown in the Minimum Distance hole chart above or as allowed using BC Calc® sizing software.

Larger holes may be possible for either single or multiple span joists; use BC Calc® sizing software for specific analysis.

Reinforced Load-Bearing Cantilever Details

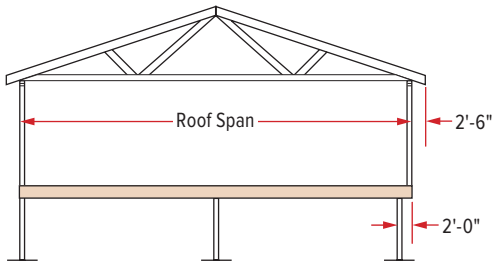

► The tables and details on pages 8 and 9 indicate the type of reinforcements, if any, that are required for load-bearing cantilevers up to a maximum length of 2'-0". Cantilevers longer than 2'-0" cannot be reinforced. However, longer cantilevers with lower loads may be allowable without reinforcement. Analyze specific applications with the BC Calc® software.

PLYWOOD / OSB REINFORCEMENT (If required, per table on page 8 or per BC Calc® analysis)

- 2³/₃₂" min. x 48" long plywood/OSB rated sheathing must match the full depth of the BCI® joist. Nail to the BCI® joist with 8d nails at 6" o.c. and nail with 4-8d nails into backer block. When reinforcing both sides, stagger nails to limit splitting. Install with face grain horizontal.
- The tables on page 8 assume a wall weight of 100 PLF, in addition to the roof loading shown. Applications with loading that exceeds the loads shown shall be analyzed with BC Calc® software.

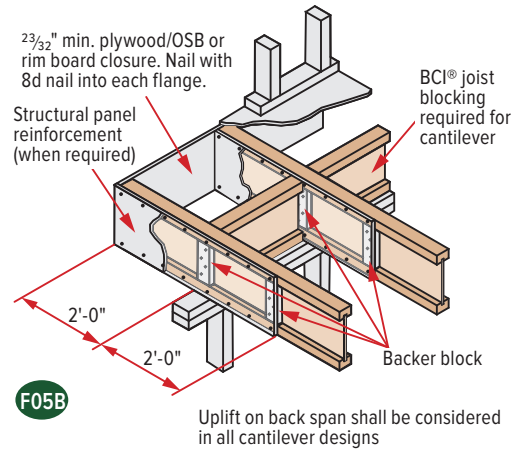

Non-Load-Bearing Wall Cantilever Details

BCI® joists are intended only for applications that provide permanent protection from the weather. Impervious moisture barrier systems shall be detailed and installed in details F15A and F15B in accordance with 2018 IBC® Sections 107.2.5 and 110.3.6.

- Fasten the 2x8 minimum to the BCI® joist by nailing through the backer block and joist web with two rows of 10d nails at 6" o.c. Clinch all nails. For BCI® 90s joists, use two rows of 16d nails on each side (four rows total) at 6" o.c.

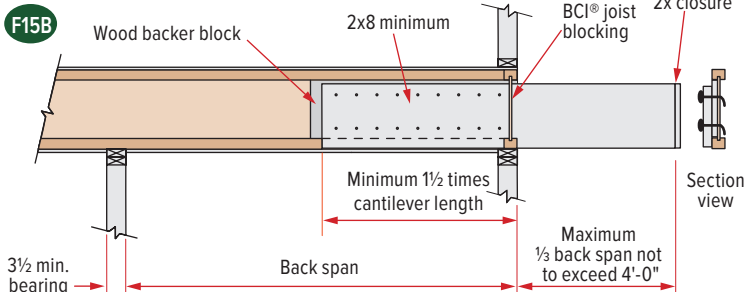
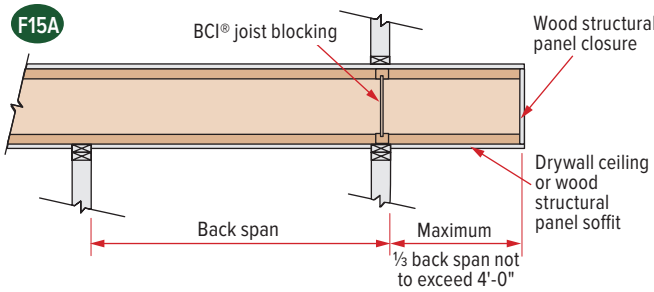

- These details apply to cantilevers with uniform loads only.
- Analyze BCI® joist cantilever condition with BC Calc® software.

- Loading shall not exceed 60 psf live load and 10 psf dead load. At least three joist members shall be present and spaced at 24" o.c. or less.
- Lumber joist shall be No. 2 Dense Southern Pine, No.1/No.2 SPF, No.2 Hem-fir, or No.2 Douglas fir, or higher grade.
- Provide positive drainage, durable materials, and venting as required in 2018 IBC Sections 2304.12.2.5 and 2304.12.2.6. Lumber joist shall be sloped.

Web Stiffener Requirements

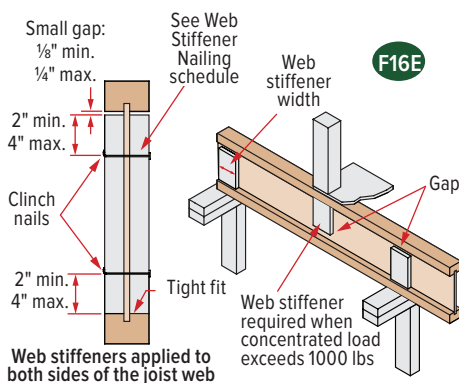

Web Stiffener Specifications

BCI® Joist Series	For Structural Capacity (Min. Thick)	Lateral Restraint in Hanger	Minimum Width
4500s	5/8"	5/8"	2 ⁵ / ₁₆ "
5000s	5/8"	3/4"	2 ⁵ / ₁₆ "
6000s	3/4"	7/8"	2 ⁵ / ₁₆ "
6500s	3/4"	1" or 1 ¹ / ₈ "	2 ⁵ / ₁₆ "
60s	3/4"	7/8"	2 ⁵ / ₁₆ "
90s	2x4 lumber (vertical)		

NOTES

Web stiffeners are optional except as noted below.

- Web stiffeners are always required:
 - for all 18" and 20" joists at all bearing locations.
 - in hangers that do not extend up to support the top flange of the BCI® joist. Web stiffeners may be required with certain sloped or skewed hangers or to achieve uplift values. Refer to the hanger manufacturer's installation requirements.
 - in certain roof applications. See Roof Framing Details on page 14.
 - under concentrated loads that exceed 1000 pounds. Install the web stiffeners snug to the top flange in this situation. Follow the nailing schedule for intermediate bearings.
 - when hanger does not laterally support the top flange (e.g., adjustable height hangers). Web stiffeners may be of multiple thickness (e.g., BCI® 6500s, double 1/2" panel OK).
 - as needed for structural capacity, to increase the BCI® joist's reaction capacity at a specific bearing location.
- Web stiffeners may be cut from structural rated wood panels, engineered rimboard or 2x lumber (BCI® 90s only).
- Web stiffeners may be used to increase allowable reaction values. See BCI® Joist Design Properties on page 24 or use BC Calc® software.

Web Stiffener Nailing Schedule

BCI® Joist Series	Depth	Bearing Location	
		End	Intermediate
4500s	9 ¹ / ₂ "	2-8d	2-8d
	11 ⁷ / ₈ "	2-8d	3-8d
	14"	2-8d	5-8d
5000s	9 ¹ / ₂ "	2-8d	2-8d
	11 ⁷ / ₈ "	2-8d	3-8d
	14"	2-8d	5-8d
6000s	9 ¹ / ₂ "	2-8d	2-8d
	11 ⁷ / ₈ "	2-8d	3-8d
	14"	2-8d	5-8d
6500s	9 ¹ / ₂ "	2-8d	2-8d
	11 ⁷ / ₈ "	2-8d	3-8d
	14"	2-8d	5-8d
60s	11 ⁷ / ₈ "	2-8d	3-8d
	14"	2-8d	5-8d
	16"	2-8d	6-8d
90s	11 ⁷ / ₈ "	3-16d	3-16d
	14"	5-16d	5-16d
	16"	6-16d	6-16d

Floor Load Tables

Allowable Uniform Floor Load (in pounds per lineal foot (PLF))

100% Load Duration

Span Length	BCI® 4500s 1.8 Joist 1¾" Flange Width								BCI® 5000s 1.8 Joist 2" Flange Width					
	9½"		11⅞"		14"		16"		9½"		11⅞"		14"	
	Live Load	Total Load	Live Load	Total Load	Live Load	Total Load	Live Load	Total Load	Live Load	Total Load	Live Load	Total Load	Live Load	Total Load
6'	–	280	–	300	–	313	–	316	–	280	–	300	–	313
7'	–	240	–	257	–	268	–	271	–	240	–	257	–	268
8'	–	210	–	225	–	235	–	237	–	210	–	225	–	235
9'	–	186	–	200	–	208	–	211	–	186	–	200	–	208
10'	147	168	–	180	–	188	–	190	163	168	–	180	–	188
11'	113	152	–	163	–	170	–	172	126	152	–	163	–	170
12'	89	131	144	150	–	156	–	158	99	140	–	150	–	156
13'	71	111	115	138	–	144	–	146	79	128	129	138	–	144
14'	57	96	94	123	–	134	–	135	64	111	105	128	–	134
15'	47	83	77	107	112	125	–	126	53	96	86	120	–	125
16'			64	94	93	112	–	118	44	85	72	108	104	117
17'			54	83	79	99	105	111			61	96	88	110
18'			46	74	67	88	89	100			51	86	75	101
19'					57	79	76	90			44	77	64	91
20'					49	71	66	81					55	82
21'					43	65	57	74					48	74
22'							50	67					42	68
23'							44	61						
24'														
25'														

NOTES

- ▶ This table was designed to apply to a broad range of applications. It may be possible to exceed the limitations of this table by analyzing a specific application with the BC Calc® software.
- ▶ Live Load values are limited by deflection equal to L/480. For deflection limits of L/360 and L/960, multiply the Live Load values by 1.33 and 0.50 respectively.
- ▶ Total Load values are limited by shear, moment, or deflection equal to L/240.
- ▶ Both the Total Load and Live Load columns must be checked. Where a Live Load value is not shown, the Total Load value will control.
- ▶ Total Load values assume minimum bearing lengths without web stiffeners for joist depths of 16" and less.
- ▶ Table values
 - apply to either simple or multiple span joists. Span is measured center to center of the minimum required bearing length. Analyze multiple span joists with the BC Calc® software if the length of any span is less than half the length of an adjacent span.
 - do not consider composite action from gluing and nailing floor sheathing (composite action is considered in floor span tables on page 4).
- ▶ For assistance with floor design, consult the section About Floor Performance on page 4.

Floor Load Tables

Allowable Uniform Floor Load
(in pounds per lineal foot (PLF))

100% Load Duration

Span Length	BCI® 6000s 1.8 Joist 2 ⁵ / ₁₆ " Flange Width								BCI® 6500s 1.8 Joist 2 ⁹ / ₁₆ " Flange Width							
	9½"		11 ⁷ / ₈ "		14"		16"		9½"		11 ⁷ / ₈ "		14"		16"	
	Live Load	Total Load	Live Load	Total Load	Live Load	Total Load	Live Load	Total Load	Live Load	Total Load	Live Load	Total Load	Live Load	Total Load	Live Load	Total Load
6'	–	320	–	333	–	346	–	353	–	320	–	333	–	346	–	353
7'	–	274	–	285	–	297	–	302	–	274	–	285	–	297	–	302
8'	–	240	–	250	–	260	–	265	–	240	–	250	–	260	–	265
9'	–	213	–	222	–	231	–	235	–	213	–	222	–	231	–	235
10'	183	192	–	200	–	208	–	212	–	192	–	200	–	208	–	212
11'	141	174	–	181	–	189	–	192	153	174	–	181	–	189	–	192
12'	112	160	–	166	–	173	–	176	121	160	–	166	–	173	–	176
13'	89	147	144	153	–	160	–	163	97	147	–	153	–	160	–	163
14'	73	129	117	142	–	148	–	151	79	137	129	142	–	148	–	151
15'	60	112	97	133	–	138	–	141	65	124	106	133	–	138	–	141
16'	50	98	81	125	117	130	–	132	54	109	89	125	127	130	–	132
17'	42	84	68	112	99	122	–	124	46	92	75	117	107	122	–	124
18'			58	100	84	115	112	117			64	110	91	115	–	117
19'			50	89	72	106	96	111			54	99	78	109	104	111
20'			43	81	62	96	83	106			47	89	68	104	90	106
21'					54	87	72	99			41	81	59	96	78	100
22'					47	79	63	90					51	88	69	96
23'					42	72	56	83					45	80	60	92
24'							49	76					40	74	53	84
25'							44	70							47	77
26'															42	72
27'																
28'																
29'																
30'																

NOTES

- ▶ Total Load values are limited by shear, moment, or deflection equal to L/240.
- ▶ Live Load values are limited by deflection equal to L/480. For deflection limits of L/360 and L/960, multiply the Live Load values by 1.33 and 0.50 respectively.
- ▶ Both the Total Load and Live Load columns must be checked. Where a Live Load value is not shown, the Total Load value will control.
- ▶ Table values apply to either simple or multiple span joists. Span is measured center to center of the minimum required bearing length. Analyze multiple span joists with the BC Calc® software if the length of any span is less than half the length of an adjacent span.
- ▶ Table values do not consider composite action from gluing and nailing floor sheathing (composite action is considered in floor span tables on page 4).
- ▶ Total Load values assume minimum bearing lengths without web stiffeners for joist depths of 16" and less.
- ▶ For assistance with floor design, consult the section *About Floor Performance* on page 4.
- ▶ This table was designed to apply to a broad range of applications. It may be possible to exceed the limitations of this table by analyzing a specific application with the BC Calc® software.

Floor Load Tables

Allowable Uniform Floor Load
(in pounds per lineal foot (PLF))

100% Load Duration

Span Length	BCI® 60s 2.0 Joist 2 ⁵ / ₁₆ " Flange Width						BCI® 90s 2.0 Joist 3 ¹ / ₂ " Flange Width					
	11 ⁷ / ₈ "		14"		16"		11 ⁷ / ₈ "		14"		16"	
	Live Load	Total Load	Live Load	Total Load	Live Load	Total Load	Live Load	Total Load	Live Load	Total Load	Live Load	Total Load
6'	–	366	–	366	–	366	–	450	–	453	–	456
7'	–	314	–	314	–	314	–	385	–	388	–	391
8'	–	275	–	275	–	275	–	337	–	340	–	342
9'	–	244	–	244	–	244	–	300	–	302	–	304
10'	–	220	–	220	–	220	–	270	–	272	–	274
11'	–	200	–	200	–	200	–	245	–	247	–	249
12'	–	183	–	183	–	183	–	225	–	226	–	228
13'	–	169	–	169	–	169	–	207	–	209	–	210
14'	155	157	–	157	–	157	–	192	–	194	–	195
15'	128	146	–	146	–	146	–	180	–	181	–	182
16'	107	137	–	137	–	137	152	168	–	170	–	171
17'	90	129	–	129	–	129	129	158	–	160	–	161
18'	77	122	110	122	–	122	110	150	–	151	–	152
19'	66	115	95	115	–	115	95	142	134	143	–	144
20'	57	110	82	110	109	110	83	135	117	136	–	137
21'	50	100	72	104	95	104	72	128	102	129	–	130
22'	43	87	63	100	84	100	63	122	90	123	119	124
23'			55	95	74	95	56	112	79	118	105	119
24'			49	91	65	91	49	99	70	113	94	114
25'			43	87	58	88	44	88	63	108	83	109
26'					52	84			56	104	75	105
27'					47	81			50	100	67	101
28'					42	78			45	91	61	97
29'									41	82	55	94
30'											50	91

NOTES

- ▶ Total Load values are limited by shear, moment, or deflection equal to L/240.
- ▶ Live Load values are limited by deflection equal to L/480. For deflection limits of L/360 and L/960, multiply the Live Load values by 1.33 and 0.50 respectively.
- ▶ Both the Total Load and Live Load columns must be checked. Where a Live Load value is not shown, the Total Load value will control.
- ▶ Table values apply to either simple or multiple span joists. Span is measured center to center of the minimum required bearing length. Analyze multiple span joists with the BC Calc® software if the length of any span is less than half the length of an adjacent span.
- ▶ Table values do not consider composite action from gluing and nailing floor sheathing (composite action is considered in floor span tables on page 4).
- ▶ Total Load values assume minimum bearing lengths without web stiffeners for joist depths of 16" and less.
- ▶ For assistance with floor design, consult the section *About Floor Performance* on page 4.
- ▶ This table was designed to apply to a broad range of applications. It may be possible to exceed the limitations of this table by analyzing a specific application with the BC Calc® software.

Roof Framing

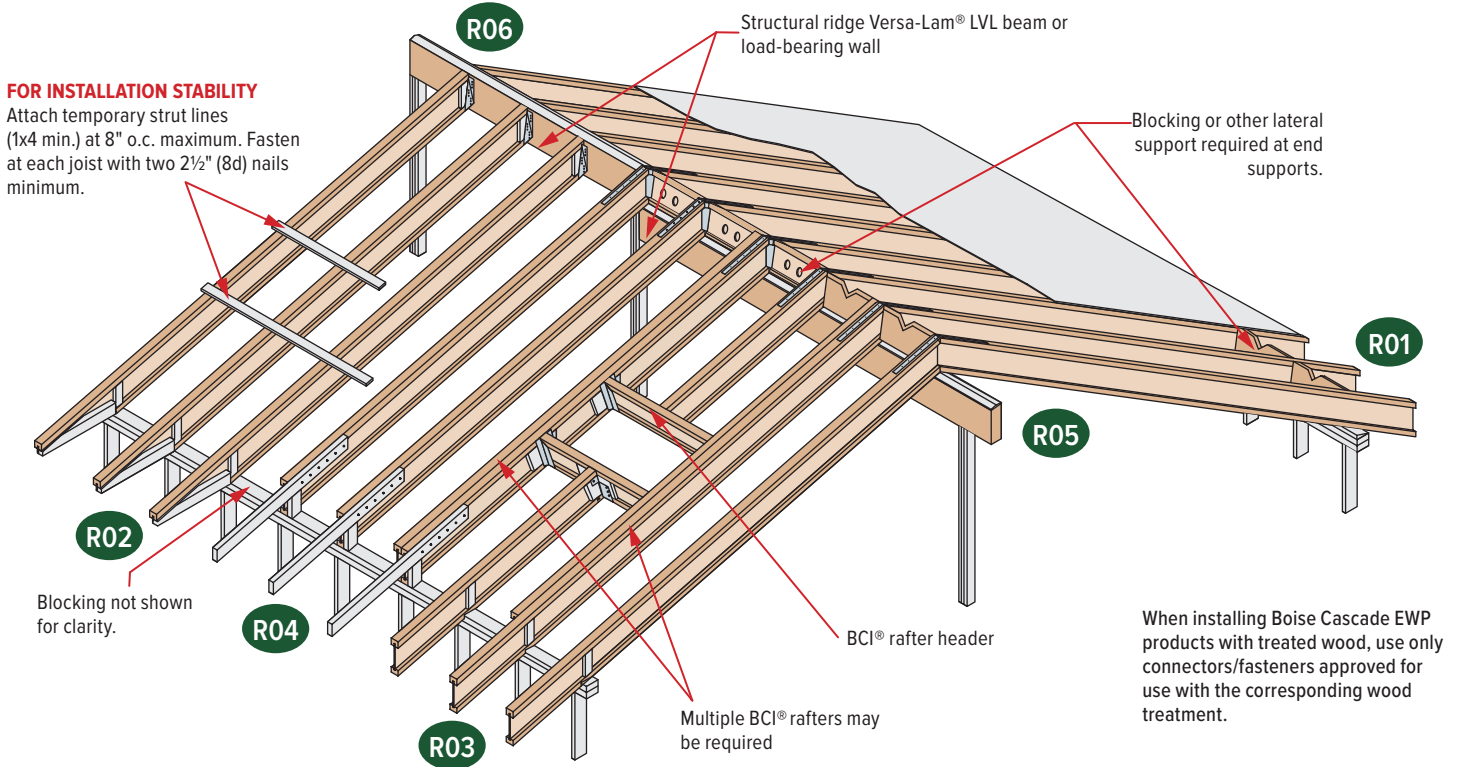

SAFETY WARNING

DO NOT ALLOW WORKERS ON BCI® JOISTS UNTIL ALL HANGERS, BCI® RIM JOISTS, RIM BOARDS, BCI® BLOCKING PANELS, X-BRACING AND TEMPORARY 1x4 STRUT LINES ARE INSTALLED AS SPECIFIED BELOW. SERIOUS ACCIDENTS CAN RESULT FROM INSUFFICIENT ATTENTION TO PROPER BRACING DURING CONSTRUCTION. ACCIDENTS CAN BE AVOIDED UNDER NORMAL CONDITIONS BY FOLLOWING THE GUIDELINES BELOW.

- ▶ Build a braced end wall at the end of the bay, or permanently install the first eight feet of BCI® joists and the first course of sheathing. As an alternate, temporary sheathing may be nailed to the first four feet of BCI® joists at the end of the bay.
- ▶ All hangers, BCI® rim joists, rim boards, BCI® blocking panels, and x-bracing must be completely installed and properly nailed as each BCI® joist is set.
- ▶ Install temporary 1x4 strut lines at no more than eight feet on-center as additional BCI® joists are set. Nail the strut lines to the sheathed area, or braced end wall, and to each BCI® joist with two 2½" (8d) nails.
- ▶ The ends of cantilevers must be temporarily secured by strut lines on both the top and bottom flanges.
- ▶ Straighten the BCI® joist to within ½" of true alignment before attaching strut lines and sheathing.
- ▶ Remove the temporary strut lines only as required to install the permanent sheathing.
- ▶ Failure to install temporary bracing may result in sideways buckling or roll-over under light construction loads.

BCI® Ceiling Joist with Bevel End Cut (For limited-access attics only)

CAUTION: DO NOT use BCI® joists as a collar/tension tie. Roof rafters shall be supported by ridge beam or other upper bearing support.

NOTES:

- ▶ Ceiling joist must be designed to carry all roof load transferred through rafter struts as shown.
- ▶ BCI® ceiling joist end reaction may not exceed 550 pounds.
- ▶ Minimum roof slope is 6:12.
- ▶ Detail is to be used only for ceiling joists with no access to attic space.
- ▶ Nail roof rafter to BCI® top flange with one 3" (10d) sinker or box nail.
- ▶ 1x4 nailers must be continuous and nailed to a braced end wall.
- ▶ Install a web stiffener on each side of BCI® joist at beveled ends. Connect roof rafter to bearing per code.

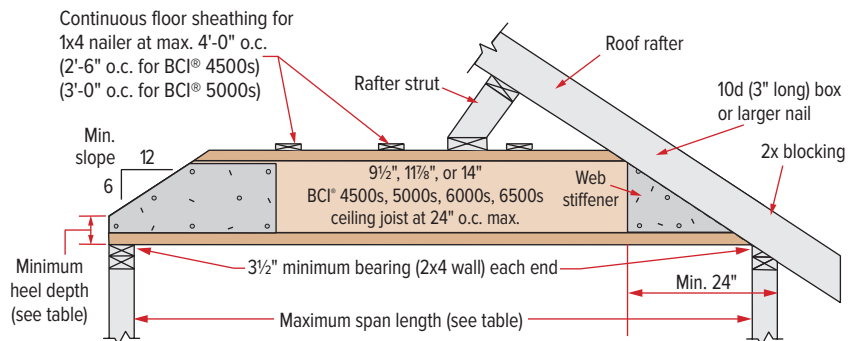

Ceiling loads: Live Load 10 psf, Dead Load 7 psf

Minimum Heel Depths

Joist Depth	End Wall	
	2 x 4	2 x 6
9½"	2½"	1½"
11⅞"	3½"	2½"
14"	4½"	3½"

Maximum Span Lengths Without Roof Loads

9½" BCI® 4500s/5000s/6000s/6500s	20'-0"
11⅞" BCI® 4500s/5000s/6000s/6500s	22'-6"
14" BCI® 4500s/5000s/6000s/6500s	24'-6"

▶ If roof loads are present, see first two notes at left.

Roof Framing Details

Additional roof framing details available with BC Framers® software

<p>R01</p> <p>2x beveled plate for slope greater than 1/4:12</p> <p>Simpson Strong-Tie VPA or MiTek TMP connectors or equal can be used in lieu of beveled plate for slopes from 3:12 to 12:12.</p>	<p>R02</p> <p>Rim board/Versa-Lam LVL blocking. Ventilation "V" cut: 1/3 of length, 1/2 of depth.</p> <p>2x4 blocking for soffit support</p> <p>16" max. joist depth for birdsmouth cut</p> <p>2'-6" max.</p> <p>BCI® joist flanges may be birdsmouth cut only at the low end of the joist, and cut flange must bear fully on plate. Web stiffener required on each side.</p>	<p>R03</p> <p>Rim board/Versa-Lam LVL blocking. Ventilation "V" cut: 1/3 of length, 1/2 of depth.</p> <p>Tight fit for lateral stability</p> <p>16" max. joist depth for birdsmouth cut</p> <p>2'-6" max.</p> <p>BCI® joist flanges may be birdsmouth cut only at the low end of the joist, and cut flange must bear fully on plate. Web stiffener required on each side.</p>
<p>R04</p> <p>10d nails at 6" o.c.</p> <p>2x4 one side for 135 PLF max. 2x6 one side for 240 PLF max.</p> <p>Backer block: Thickness per corresponding BCI® joist series</p> <p>4'0" horiz.</p> <p>2'6" horiz.</p> <p>2x block</p> <p>BCI® joist blocking holes cut for ventilation</p>	<p>R05</p> <p>Simpson Strong-Tie or MiTek LSTA24 strap, nail per governing building code</p> <p>BCI® blocking holes cut for ventilation</p> <p>Blocking on both sides of ridge may be required for shear transfer per design professional of record.</p> <p>Double-bevel wood plate</p> <p>Versa-Lam LVL support beam</p>	<p>R06</p> <p>Simpson Strong-Tie or MiTek LSTA24 strap where slope exceeds 7:12 (straps may be required for lower slopes in high-wind areas). Nail per building code.</p> <p>Versa-Lam LVL support beam</p> <p>Simpson Strong-Tie LSSUI or MiTek TMU hanger</p> <p>Beveled web stiffener on each side</p>
<p>R07</p> <p>Backer block (minimum 12" wide). Nail with ten 10d nails.</p> <p>Joist hanger</p> <p>Filler block: Nail with ten 10d nails.</p> <p>A backer block is required where the top flange hanger load exceeds 250 lbs. All face mount hangers require backer blocks on both sides of the supporting joist's web. For top flange hangers install tight to top flange. For face mount hangers, install tight to the bottom flange.</p>	<p>R11</p> <p>Double joist may be required when L exceeds rafter spacing.</p> <p>Blocking as required</p> <p>Nail outrigger through BCI® joist web</p> <p>2" x _ outrigger notched around BCI® joist top flange. Outrigger spacing no greater than 24" o.c.</p> <p>End wall</p>	<p>DN05</p> <p>DO NOT bevel-cut joist beyond the inside face of wall, except for specific conditions as shown in detail F14 on page 6. Also see page 13.</p>

Lateral Support

- BCI® joists must be laterally supported at the ends (including supports adjacent to overhangs) with hangers, rim board, or blocking (Versa-Lam LVL®, Boise Cascade® Rimboard, or BCI® joist). Metal cross bracing or other x-bracing provides adequate lateral support for BCI® joists. Consult governing building code for roof diaphragm connection provisions.

Minimum Bearing Length For BCI® Joists

- Minimum end bearing: 1 1/2" for all BCI® joists. 3 1/2" required at cantilever and intermediate supports.
- Longer bearing lengths allow higher reaction values. Refer to the building code evaluation report or the BC Calc® software.

Nailing Requirements

- BCI® rim joist, rim board or closure panel to BCI® joist:**
 - Rims or closure panel:** Two nails, one each in the top and bottom flange; Up to 1 1/2" thick rim, use 8d x 2 1/2" nails; for 1 3/4" thick rim, use 10d box x 3" nails.
 - BCI® 5000 rim joist:** Two 10d box nails, one each in the top and bottom flange.
 - BCI® 6000/60 rim joist:** Two 16d box nails, one each in the top and bottom flange.
 - BCI® 6500/90 rim joist:** Toe-nail top flange to rim joist with Two 10d box nails, one each side of flange.
- BCI® rim joist, rim board or BCI® blocking panel to support:**
 - Min. 8d nails at 6" o.c. per IRC®.
 - Connection per design professional of record's specification for shear transfer.

BCI® joist to support:

- Two 8d nails, one on each side of the web, placed 1 1/2" minimum from the end of the BCI® joist to limit splitting.

Sheathing to BCI® joist:

- Prescriptive residential roof sheathing nailing requires 8d common nails at 6" o.c. on edges and at 12" o.c. in the field (IRC® Table R602.3(1)).
- See closest allowable nail spacing limits on page 24 for floor diaphragm nailing specified at closer spacing than IRC®.
- For full lateral stability, maximum nail spacing for bracing is 18" for BCI® 4500s and 5000s, and 24" for larger BCI® joist series.
- 14 gauge staples may be substituted for 8d nails if the staples penetrate at least 1" into the joist.
- Wood screws may be acceptable, contact local building official and/or Boise Cascade EWP Engineering for more information.

Web Stiffeners

- See Web Stiffener Requirements on page 9.

Maximum Slope

- Unless otherwise noted, all roof details are valid for slopes of 12:12 or less.

Ventilation

- All 1 1/2", prepunched knock-out holes spaced at 12" o.c. along the BCI® joist may be knocked out and used for cross ventilation. When designing ventilation, using deeper joists than what is structurally required may be an advantage. Consult local building officials and/or ventilation specialists for specific requirements.

Birdsmouth Cuts

- BCI® joists may be birdsmouth cut only at the low end support.
- BCI® joists with birdsmouth cuts may cantilever up to 2'-6" past the low end support.
- The bottom flange must sit fully on the support and may not overhang the inside face of the support.
- Birdsmouth cuts are NOT allowed at high end or intermediate supports.

Backer and Filler Block Dimensions

Series	Backer Block Thickness	Filler Block Thickness
4500s	5/8" or 3/4" wood panels	Two 5/8" wood panels or 2 x _
5000s	3/4" or 7/8" wood panels	Two 3/4" wood panels or 2 x _
6000s	1 1/8" or two 1/2" wood panels	2 x _ + 7/16" or 1/2" wood panel
6500s	1 1/8" or two 5/8" wood panels	2 x _ + 5/8" or 3/4" wood panel
60s	1 1/8" or two 1/2" wood panels	2 x _ + 7/16" or 1/2" wood panel
90s	2 x _ lumber	Double 2 x _ lumber

- Cut backer and filler blocks to a maximum depth equal to the web depth minus 1/4" to avoid a forced fit.

Roof Span Tables

Maximum clear span in feet and inches, based on horizontal spans.

115% and 125% Load Duration

Condition			BCI® 4500s 1.8 Joist												BCI® 5000s 1.8 Joist									
			9½"			11⅞"			14"			16"			9½"			11⅞"			14"			
O.C. Spacing and Load Duration	Live Load (psf)	Dead Load (psf)	4:12 or Less	4:12 to 8:12	8:12 to 12:12	4:12 or Less	4:12 to 8:12	8:12 to 12:12	4:12 or Less	4:12 to 8:12	8:12 to 12:12	4:12 or Less	4:12 to 8:12	8:12 to 12:12	4:12 or Less	4:12 to 8:12	8:12 to 12:12	4:12 or Less	4:12 to 8:12	8:12 to 12:12	4:12 or Less	4:12 to 8:12	8:12 to 12:12	
12" o.c.	Non-Snow 125%	20	10	23'-10"	22'-6"	20'-10"	28'-5"	26'-9"	24'-10"	32'-3"	30'-5"	28'-3"	35'-9"	33'-8"	31'-3"	24'-10"	23'-5"	21'-9"	29'-7"	27'-11"	25'-11"	33'-8"	31'-9"	29'-5"
		20	15	22'-7"	21'-3"	19'-7"	26'-11"	25'-3"	23'-4"	30'-7"	28'-9"	26'-6"	33'-6"	31'-10"	29'-4"	23'-6"	22'-1"	20'-5"	28'-0"	26'-4"	24'-4"	31'-10"	29'-11"	27'-7"
		20	20	21'-7"	20'-2"	18'-7"	25'-8"	24'-0"	22'-1"	29'-2"	27'-4"	25'-1"	31'-4"	30'-3"	27'-10"	22'-5"	21'-0"	19'-4"	26'-9"	25'-0"	23'-0"	30'-5"	28'-5"	26'-2"
	Snow 115%	25	10	22'-8"	21'-5"	19'-11"	26'-11"	25'-6"	23'-8"	30'-2"	29'-0"	26'-11"	32'-3"	31'-7"	29'-10"	23'-7"	22'-4"	20'-9"	28'-1"	26'-7"	24'-9"	31'-11"	30'-2"	28'-1"
		25	15	21'-7"	20'-4"	18'-10"	25'-9"	24'-2"	22'-5"	28'-2"	27'-5"	25'-6"	30'-1"	29'-4"	28'-3"	22'-6"	21'-2"	19'-7"	26'-10"	25'-3"	23'-4"	30'-3"	28'-8"	26'-7"
		30	10	21'-8"	20'-6"	19'-1"	25'-9"	24'-5"	22'-9"	28'-3"	27'-9"	25'-11"	30'-2"	29'-8"	28'-8"	22'-7"	21'-4"	19'-11"	26'-10"	25'-5"	23'-9"	30'-4"	28'-11"	27'-0"
		30	15	20'-9"	19'-7"	18'-2"	24'-5"	23'-4"	21'-8"	26'-7"	25'-11"	24'-7"	28'-5"	27'-9"	26'-10"	21'-7"	20'-5"	18'-11"	25'-9"	24'-4"	22'-7"	28'-6"	27'-8"	25'-8"
		40	10	19'-8"	18'-11"	17'-10"	23'-2"	22'-6"	21'-3"	25'-3"	24'-11"	24'-2"	27'-0"	26'-8"	26'-1"	20'-6"	19'-8"	18'-7"	24'-5"	23'-5"	22'-2"	27'-2"	26'-8"	25'-2"
		40	15	19'-5"	18'-4"	17'-1"	22'-1"	21'-8"	20'-4"	24'-1"	23'-7"	22'-11"	25'-8"	25'-2"	24'-6"	20'-2"	19'-1"	17'-10"	23'-8"	22'-9"	21'-3"	25'-10"	25'-4"	24'-1"
		50	10	18'-3"	17'-6"	16'-7"	21'-2"	20'-10"	19'-9"	23'-1"	22'-10"	22'-5"	24'-8"	24'-4"	24'-0"	19'-0"	18'-3"	17'-3"	22'-8"	21'-9"	20'-7"	24'-10"	24'-6"	23'-5"
50	15	17'-11"	17'-4"	16'-3"	20'-4"	20'-0"	19'-4"	22'-2"	21'-9"	21'-3"	23'-8"	23'-3"	22'-9"	19'-0"	18'-1"	16'-11"	21'-10"	21'-5"	20'-2"	23'-9"	23'-4"	22'-10"		
16" o.c.	Non-Snow 125%	20	10	21'-7"	20'-5"	18'-11"	25'-9"	24'-3"	22'-6"	29'-3"	27'-7"	25'-7"	31'-5"	30'-7"	28'-4"	22'-6"	21'-3"	19'-8"	26'-10"	25'-4"	23'-6"	30'-6"	28'-9"	26'-8"
		20	15	20'-6"	19'-3"	17'-9"	24'-4"	22'-11"	21'-1"	27'-2"	26'-0"	24'-0"	29'-0"	28'-2"	26'-7"	21'-4"	20'-0"	18'-6"	25'-5"	23'-10"	22'-0"	28'-11"	27'-1"	25'-0"
		20	20	19'-6"	18'-3"	16'-10"	23'-3"	21'-9"	20'-0"	25'-4"	24'-5"	22'-9"	27'-1"	26'-2"	24'-11"	20'-4"	19'-7"	17'-6"	24'-3"	22'-8"	20'-10"	27'-2"	25'-10"	23'-9"
	Snow 115%	25	10	20'-6"	19'-5"	18'-1"	24'-0"	23'-1"	21'-6"	26'-1"	25'-7"	24'-5"	27'-11"	27'-4"	26'-7"	21'-4"	20'-2"	18'-10"	25'-6"	24'-1"	22'-5"	28'-1"	27'-4"	25'-6"
		25	15	19'-7"	18'-5"	17'-1"	22'-4"	21'-9"	20'-4"	24'-4"	23'-9"	22'-11"	26'-0"	25'-4"	24'-5"	20'-5"	19'-2"	17'-9"	24'-0"	22'-10"	21'-2"	26'-2"	25'-6"	24'-1"
		30	10	19'-7"	18'-7"	17'-4"	22'-5"	22'-0"	20'-7"	24'-5"	24'-0"	23'-5"	26'-1"	25'-8"	25'-0"	20'-5"	19'-4"	18'-1"	24'-1"	23'-1"	21'-6"	26'-3"	25'-9"	24'-5"
		30	15	18'-7"	17'-9"	16'-6"	21'-1"	20'-7"	19'-7"	23'-0"	22'-5"	21'-9"	24'-7"	24'-0"	23'-3"	19'-7"	18'-6"	17'-2"	22'-8"	22'-0"	20'-5"	24'-8"	24'-1"	23'-3"
		40	10	17'-8"	17'-1"	16'-2"	20'-1"	19'-9"	19'-3"	21'-10"	21'-7"	21'-1"	23'-4"	23'-0"	22'-7"	18'-7"	17'-10"	16'-10"	21'-7"	21'-3"	20'-1"	23'-6"	23'-2"	22'-8"
		40	15	16'-10"	16'-6"	15'-6"	19'-1"	18'-8"	18'-2"	20'-10"	20'-5"	19'-10"	22'-3"	21'-10"	21'-3"	18'-1"	17'-4"	16'-1"	20'-6"	20'-1"	19'-3"	22'-4"	21'-11"	21'-4"
		50	10	16'-2"	15'-10"	15'-0"	18'-4"	18'-1"	17'-9"	19'-11"	19'-9"	19'-5"	21'-4"	21'-1"	20'-9"	17'-2"	16'-6"	15'-8"	19'-8"	19'-5"	18'-8"	21'-5"	21'-2"	20'-10"
50	15	15'-6"	15'-3"	14'-8"	17'-7"	17'-3"	16'-10"	19'-2"	18'-10"	18'-5"	20'-5"	20'-1"	19'-8"	16'-8"	16'-4"	15'-4"	18'-10"	18'-6"	18'-1"	20'-7"	20'-2"	19'-9"		
19.2" o.c.	Non-Snow 125%	20	10	20'-4"	19'-2"	17'-9"	24'-2"	22'-10"	21'-2"	26'-10"	25'-11"	24'-1"	28'-8"	28'-0"	26'-8"	21'-2"	19'-11"	18'-6"	25'-2"	23'-9"	22'-1"	28'-8"	27'-0"	25'-1"
		20	15	19'-3"	18'-1"	16'-8"	22'-9"	21'-6"	19'-10"	24'-9"	24'-0"	22'-7"	26'-5"	25'-8"	24'-8"	20'-0"	18'-10"	17'-4"	23'-10"	22'-5"	20'-8"	26'-7"	25'-6"	23'-6"
		20	20	18'-4"	17'-2"	15'-9"	21'-2"	20'-5"	18'-9"	23'-1"	22'-4"	21'-3"	24'-8"	23'-10"	22'-9"	19'-1"	17'-10"	16'-5"	22'-9"	21'-4"	19'-7"	24'-10"	23'-11"	22'-3"
	Snow 115%	25	10	19'-3"	18'-3"	17'-0"	21'-10"	21'-5"	20'-2"	23'-10"	23'-4"	22'-8"	25'-6"	24'-11"	24'-3"	20'-1"	19'-7"	17'-8"	23'-6"	22'-7"	21'-1"	25'-7"	25'-1"	23'-11"
		25	15	18'-0"	17'-4"	16'-0"	20'-5"	19'-10"	19'-1"	22'-3"	21'-8"	20'-10"	23'-9"	23'-1"	22'-4"	19'-2"	18'-0"	16'-8"	21'-11"	21'-4"	19'-11"	23'-10"	23'-3"	22'-5"
		30	10	18'-0"	17'-5"	16'-3"	20'-5"	20'-1"	19'-5"	22'-3"	21'-11"	21'-4"	23'-10"	23'-5"	22'-10"	19'-2"	18'-2"	16'-11"	22'-0"	21'-7"	20'-2"	23'-11"	23'-6"	22'-11"
		30	15	16'-11"	16'-7"	15'-6"	19'-3"	18'-9"	18'-2"	20'-11"	20'-5"	19'-10"	22'-5"	21'-10"	21'-2"	18'-3"	17'-4"	16'-1"	20'-8"	20'-2"	19'-2"	22'-6"	22'-0"	21'-3"
		40	10	16'-2"	15'-11"	15'-2"	18'-3"	18'-0"	17'-8"	19'-11"	19'-8"	19'-3"	21'-4"	21'-0"	20'-7"	17'-4"	16'-9"	15'-10"	19'-8"	19'-4"	18'-10"	21'-5"	21'-1"	20'-8"
		40	15	15'-4"	15'-0"	14'-6"	17'-5"	17'-1"	16'-7"	18'-11"	18'-7"	18'-1"	20'-3"	19'-10"	19'-4"	16'-6"	16'-2"	15'-2"	18'-8"	18'-4"	17'-10"	20'-4"	20'-0"	19'-5"
		50	10	14'-9"	14'-6"	14'-1"	16'-8"	16'-6"	16'-2"	18'-2"	18'-0"	17'-8"	19'-5"	19'-3"	18'-11"	15'-10"	15'-6"	14'-8"	17'-11"	17'-9"	17'-5"	19'-7"	19'-4"	19'-0"
50	15	14'-1"	13'-10"	13'-7"	16'-0"	15'-9"	15'-4"	17'-5"	17'-2"	16'-9"	18'-8"	18'-4"	17'-11"	15'-2"	14'-11"	14'-4"	17'-2"	16'-11"	16'-6"	18'-9"	18'-5"	18'-0"		
24" o.c.	Non-Snow 125%	20	10	18'-10"	17'-9"	16'-6"	22'-0"	21'-1"	19'-7"	24'-0"	23'-5"	22'-4"	25'-7"	25'-0"	24'-3"	19'-7"	18'-6"	17'-2"	23'-4"	22'-0"	20'-5"	25'-9"	25'-0"	23'-3"
		20	15	17'-10"	16'-9"	15'-5"	20'-3"	19'-8"	18'-4"	22'-1"	21'-5"	20'-7"	23'-8"	22'-11"	22'-0"	18'-6"	17'-5"	16'-1"	21'-10"	20'-9"	19'-2"	23'-9"	23'-1"	21'-9"
		20	20	16'-8"	15'-11"	14'-7"	18'-11"	18'-3"	17'-5"	20'-8"	19'-11"	19'-0"	22'-1"	21'-3"	20'-4"	17'-8"	16'-7"	15'-3"	20'-4"	19'-8"	18'-2"	22'-2"	21'-5"	20'-5"
	Snow 115%	25	10	17'-3"	16'-10"	15'-9"	19'-6"	19'-2"	18'-7"	21'-3"	20'-10"	20'-3"	22'-9"	22'-3"	21'-8"	18'-6"	17'-7"	16'-4"	21'-0"	20'-7"	19'-6"	22'-10"	22'-5"	21'-9"
		25	15	16'-1"	15'-7"	14'-10"	18'-2"	17'-9"	17'-1"	19'-10"	19'-4"	18'-8"	21'-3"	20'-8"	19'-11"	17'-3"	16'-8"	15'-5"	19'-7"	19'-1"	18'-4"	21'-4"	20'-9"	20'-0"
		30	10	16'-1"	15'-10"	15'-1"	18'-3"	17'-11"	17'-6"	19'-11"	19'-7"	19'-1"	21'-3"	20'-11"	20'-5"	17'-4"	16'-10"	15'-8"	19'-7"	19'-3"	18'-9"	21'-5"	21'-0"	20'-6"
		30	15	15'-2"	14'-9"	14'-4"	17'-2"	16'-9"	16'-3"	18'-9"	18'-3"	17'-8"	20'-0"	19'-6"	18'-11"	16'-3"	15'-11"	14'-11"	18'-5"	18'-0"	17'-5"	20'-1"	19'-8"	19'-0"
		40	10	14'-5"	14'-2"	13'-11"	16'-4"	16'-1"	15'-9"	17'-10"	17'-7"	17'-2"	19'-0"	18'-9"	18'-5"	15'-6"	15'-3"	14'-7"	17'-7"	17'-4"	16'-11"	19'-2"	18'-10"	18'-6"
		40	15	13'-8"	13'-5"	13'-1"	15'-6"	15'-3"	14'-10"	16'-11"	16'-7"	16'-2"	18'-1"	17'-9"	17'-3"	14'-9"	14'-5"	14'-0"	16'-8"	16'-4"	15'-11"	18'-2"	17'-10"	17'-4"
		50	10	13'-2"	13'-0"	12'-9"	14'-11"	14'-9"	14'-6"	16'-3"	16'-1"	15'-9"	17'-4"	17'-2"	16'-10"	14'-2"	13'-11"	13'-7"	16'-0"	15'-10"	15'-7"	17'-5"	17'-2"	16'-7"
50	15	12'-7"	12'-4"	12'-1"	14'-3"	14'-0"	13'-9"	15'-7"	15'-4"	14'-11"	16'-6"	16'-0"	15'-3"	13'-6"	13'-4"	13'-0"	15'-4"	14'-11"	14'-3"	16'-2"	15'-8"	14'-11"		

NOTES

- ▶ Table values
 - are limited by shear, moment, total load deflection equal to L/180 and live load deflection equal to L/240. Check the local building code for other deflection limits that may apply.
 - represent the most restrictive of simple or multiple span applications. Analyze multiple span joists with the BC Calc® software if the length of any span is less than half the length of an adjacent span.
 - assume minimum bearing lengths without web stiffeners for joist depths of 16" and less.
- ▶ This table was designed to apply to a broad range of applications. It may be possible to exceed the limitations of this table by analyzing a specific application with the BC Calc® software.
- ▶ Slope roof joists at least ¼:12 to minimize ponding.
- ▶ Allowable spans and loads shall be adjusted and checked for wind load as required by local building code.

Roof Span Tables

Maximum clear span in feet and inches, based on horizontal spans.

115% and 125% Load Duration

Condition			BCI® 6000s 1.8 Joist												
			9½"			11⅞"			14"			16"			
O.C. Spacing and Load Duration	Live Load (psf)	Dead Load (psf)	4:12 or Less	4:12 to 8:12	8:12 to 12:12	4:12 or Less	4:12 to 8:12	8:12 to 12:12	4:12 or Less	4:12 to 8:12	8:12 to 12:12	4:12 or Less	4:12 to 8:12	8:12 to 12:12	
12" o.c.	Non-Snow 125%	20	10	26'-0"	24'-6"	22'-9"	30'-11"	29'-2"	27'-0"	35'-2"	33'-2"	30'-9"	38'-10"	36'-7"	34'-0"
		20	15	24'-7"	23'-1"	21'-4"	29'-3"	27'-6"	25'-4"	33'-3"	31'-3"	28'-10"	36'-9"	34'-6"	31'-10"
		20	20	23'-6"	22'-0"	20'-2"	27'-11"	26'-1"	24'-0"	31'-9"	29'-9"	27'-4"	35'-1"	32'-10"	30'-2"
	Snow 115%	25	10	24'-8"	23'-4"	21'-8"	29'-4"	27'-9"	25'-10"	33'-4"	31'-6"	29'-4"	36'-10"	34'-10"	32'-5"
		25	15	23'-6"	22'-2"	20'-6"	28'-0"	26'-4"	24'-5"	31'-10"	29'-11"	27'-9"	34'-11"	33'-1"	30'-8"
		30	10	23'-7"	22'-4"	20'-10"	28'-0"	26'-7"	24'-9"	31'-11"	30'-2"	28'-2"	35'-1"	33'-5"	31'-2"
		30	15	22'-7"	21'-4"	19'-9"	26'-11"	25'-4"	23'-6"	30'-7"	28'-10"	26'-9"	33'-0"	31'-11"	29'-7"
		40	10	21'-5"	20'-7"	19'-5"	25'-6"	24'-6"	23'-1"	29'-0"	27'-10"	26'-3"	31'-4"	30'-9"	29'-0"
		40	15	21'-1"	20'-0"	18'-7"	25'-1"	23'-9"	22'-2"	27'-11"	27'-1"	25'-2"	29'-10"	29'-3"	27'-10"
		50	10	19'-10"	19'-1"	18'-1"	23'-7"	22'-8"	21'-6"	26'-9"	25'-9"	24'-6"	28'-8"	28'-3"	27'-1"
50	15	19'-10"	18'-11"	17'-8"	23'-7"	22'-6"	21'-0"	25'-8"	25'-3"	23'-11"	27'-5"	27'-0"	26'-5"		
16" o.c.	Non-Snow 125%	20	10	23'-6"	22'-2"	20'-7"	28'-0"	26'-5"	24'-6"	31'-10"	30'-0"	27'-10"	35'-2"	33'-2"	30'-10"
		20	15	22'-3"	20'-11"	19'-4"	26'-6"	24'-11"	23'-0"	30'-2"	28'-4"	26'-2"	33'-4"	31'-4"	28'-11"
		20	20	21'-3"	19'-11"	18'-4"	25'-3"	23'-8"	21'-9"	28'-9"	26'-11"	24'-9"	31'-5"	29'-9"	27'-5"
	Snow 115%	25	10	22'-4"	21'-1"	19'-8"	26'-7"	25'-1"	23'-5"	30'-3"	28'-7"	26'-7"	32'-5"	31'-7"	29'-5"
		25	15	21'-4"	20'-1"	18'-7"	25'-4"	23'-10"	22'-1"	28'-3"	27'-2"	25'-2"	30'-3"	29'-5"	27'-9"
		30	10	21'-4"	20'-3"	18'-10"	25'-5"	24'-1"	22'-5"	28'-4"	27'-4"	25'-6"	30'-4"	29'-9"	28'-3"
		30	15	20'-6"	19'-4"	17'-11"	24'-4"	23'-0"	21'-4"	26'-8"	26'-0"	24'-3"	28'-6"	27'-10"	26'-10"
		40	10	19'-5"	18'-7"	17'-7"	23'-1"	22'-2"	20'-11"	25'-5"	25'-0"	23'-10"	27'-2"	26'-9"	26'-2"
		40	15	19'-1"	18'-1"	16'-10"	22'-2"	21'-6"	20'-1"	24'-2"	23'-8"	22'-10"	25'-10"	25'-4"	24'-8"
		50	10	18'-0"	17'-3"	16'-4"	21'-3"	20'-6"	19'-6"	23'-2"	22'-11"	22'-2"	24'-9"	24'-6"	24'-1"
50	15	17'-11"	17'-1"	16'-0"	20'-4"	20'-0"	19'-0"	22'-2"	21'-10"	21'-4"	23'-9"	23'-4"	22'-10"		
19.2" o.c.	Non-Snow 125%	20	10	22'-1"	20'-10"	19'-4"	26'-3"	24'-10"	23'-0"	29'-11"	28'-3"	26'-2"	33'-1"	31'-2"	28'-11"
		20	15	20'-11"	19'-8"	18'-2"	24'-11"	23'-5"	21'-7"	28'-4"	26'-7"	24'-7"	30'-8"	29'-5"	27'-2"
		20	20	19'-11"	18'-8"	17'-2"	23'-9"	22'-3"	20'-5"	26'-10"	25'-4"	23'-3"	28'-8"	27'-8"	25'-9"
	Snow 115%	25	10	21'-0"	19'-10"	18'-6"	24'-11"	23'-7"	22'-0"	27'-8"	26'-10"	25'-0"	29'-7"	28'-11"	27'-8"
		25	15	20'-0"	18'-10"	17'-5"	23'-8"	22'-5"	20'-9"	25'-9"	25'-1"	23'-7"	27'-7"	26'-10"	25'-11"
		30	10	20'-1"	19'-0"	17'-9"	23'-9"	22'-7"	21'-1"	25'-10"	25'-5"	24'-0"	27'-8"	27'-2"	26'-6"
		30	15	19'-3"	18'-2"	16'-10"	22'-4"	21'-7"	20'-0"	24'-4"	23'-9"	22'-10"	26'-0"	25'-5"	24'-7"
		40	10	18'-3"	17'-6"	16'-6"	21'-3"	20'-10"	19'-8"	23'-2"	22'-10"	22'-4"	24'-9"	24'-5"	23'-11"
		40	15	17'-10"	17'-0"	15'-10"	20'-2"	19'-10"	18'-10"	22'-0"	21'-7"	21'-0"	23'-6"	23'-1"	22'-6"
		50	10	16'-10"	16'-2"	15'-4"	19'-5"	19'-2"	18'-3"	21'-1"	20'-10"	20'-6"	22'-7"	22'-4"	21'-11"
50	15	16'-4"	16'-1"	15'-0"	18'-7"	18'-3"	17'-10"	20'-3"	19'-11"	19'-5"	21'-8"	21'-3"	20'-10"		
24" o.c.	Non-Snow 125%	20	10	20'-6"	19'-4"	17'-11"	24'-4"	23'-0"	21'-4"	27'-9"	26'-2"	24'-3"	29'-9"	28'-11"	26'-10"
		20	15	19'-4"	18'-2"	16'-10"	23'-0"	21'-8"	20'-0"	25'-8"	24'-8"	22'-9"	27'-5"	26'-7"	25'-2"
		20	20	18'-6"	17'-3"	15'-11"	22'-0"	20'-7"	18'-11"	23'-11"	23'-1"	21'-7"	25'-7"	24'-9"	23'-7"
	Snow 115%	25	10	19'-5"	18'-4"	17'-1"	22'-8"	21'-10"	20'-4"	24'-8"	24'-2"	23'-2"	26'-5"	25'-10"	25'-2"
		25	15	18'-6"	17'-5"	16'-2"	21'-2"	20'-7"	19'-3"	23'-0"	22'-5"	21'-8"	24'-8"	24'-0"	23'-2"
		30	10	18'-7"	17'-7"	16'-5"	21'-2"	20'-10"	19'-6"	23'-1"	22'-8"	22'-2"	24'-9"	24'-3"	23'-8"
		30	15	17'-7"	16'-9"	15'-7"	19'-11"	19'-6"	18'-7"	21'-9"	21'-3"	20'-6"	23'-3"	22'-8"	21'-11"
		40	10	16'-9"	16'-2"	15'-3"	19'-0"	18'-8"	18'-2"	20'-8"	20'-4"	20'-0"	22'-1"	21'-9"	21'-4"
		40	15	15'-11"	15'-7"	14'-8"	18'-0"	17'-8"	17'-2"	19'-8"	19'-3"	18'-9"	21'-0"	20'-7"	19'-8"
		50	10	15'-3"	14'-11"	14'-3"	17'-4"	17'-1"	16'-10"	18'-10"	18'-8"	18'-4"	19'-10"	19'-5"	18'-9"
50	15	14'-7"	14'-4"	13'-11"	16'-7"	16'-4"	15'-11"	17'-11"	17'-4"	16'-6"	18'-3"	17'-8"	16'-10"		

NOTES

- ▶ Table values
 - are limited by shear, moment, total load deflection equal to L/180 and live load deflection equal to L/240. Check the local building code for other deflection limits that may apply.
 - represent the most restrictive of simple or multiple span applications. Analyze multiple span joists with the BC Calc® software if the length of any span is less than half the length of an adjacent span.
 - assume minimum bearing lengths without web stiffeners for joist depths of 16" and less.
- ▶ This table was designed to apply to a broad range of applications. It may be possible to exceed the limitations of this table by analyzing a specific application with the BC Calc® software.
- ▶ Slope roof joists at least ¼:12 to minimize ponding.
- ▶ Allowable spans and loads shall be adjusted and checked for wind load as required by local building code.

Roof Span Tables

Maximum clear span in feet and inches, based on horizontal spans.

115% and 125% Load Duration

Condition			BCI® 6500s 1.8 Joist												
			9½"			11⅞"			14"			16"			
O.C. Spacing and Load Duration	Live Load (psf)	Dead Load (psf)	4:12 or Less	4:12 to 8:12	8:12 to 12:12	4:12 or Less	4:12 to 8:12	8:12 to 12:12	4:12 or Less	4:12 to 8:12	8:12 to 12:12	4:12 or Less	4:12 to 8:12	8:12 to 12:12	
12" o.c.	Non-Snow 125%	20	10	26'-10"	25'-3"	23'-6"	31'-10"	30'-0"	27'-10"	36'-2"	34'-1"	31'-8"	40'-0"	37'-8"	35'-0"
		20	15	25'-5"	23'-10"	22'-0"	30'-2"	28'-4"	26'-1"	34'-3"	32'-2"	29'-8"	37'-10"	35'-7"	32'-10"
		20	20	24'-3"	22'-8"	20'-10"	28'-9"	26'-11"	24'-9"	32'-8"	30'-7"	28'-2"	36'-1"	33'-10"	31'-1"
	Snow 115%	25	10	25'-5"	24'-1"	22'-5"	30'-3"	28'-7"	26'-7"	34'-4"	32'-6"	30'-3"	37'-11"	35'-10"	33'-5"
		25	15	24'-3"	22'-10"	21'-2"	28'-10"	27'-2"	25'-1"	32'-9"	30'-10"	28'-7"	36'-2"	34'-1"	31'-7"
		30	10	24'-4"	23'-0"	21'-6"	28'-11"	27'-4"	25'-6"	32'-10"	31'-1"	29'-0"	36'-3"	34'-4"	32'-1"
		30	15	23'-4"	22'-0"	20'-5"	27'-8"	26'-2"	24'-3"	31'-6"	29'-9"	27'-7"	34'-8"	32'-10"	30'-6"
		40	10	22'-2"	21'-3"	20'-0"	26'-4"	25'-3"	23'-10"	29'-11"	28'-8"	27'-1"	33'-0"	31'-8"	29'-11"
		40	15	21'-9"	20'-7"	19'-3"	25'-11"	24'-6"	22'-10"	29'-5"	27'-10"	25'-11"	31'-5"	30'-9"	28'-8"
		50	10	20'-6"	19'-8"	18'-8"	24'-4"	23'-4"	22'-2"	27'-8"	26'-7"	25'-2"	30'-2"	29'-4"	27'-10"
		50	15	20'-6"	19'-6"	18'-3"	24'-4"	23'-2"	21'-8"	27'-0"	26'-4"	24'-8"	28'-11"	28'-5"	27'-3"
		16" o.c.	Non-Snow 125%	20	10	24'-4"	22'-11"	21'-3"	28'-10"	27'-2"	25'-3"	32'-10"	30'-11"	28'-8"	36'-3"
20	15			23'-4"	21'-7"	19'-11"	27'-4"	25'-5"	23'-8"	31'-1"	29'-2"	26'-11"	34'-4"	32'-3"	29'-9"
20	20			21'-11"	20'-6"	18'-11"	26'-1"	24'-5"	22'-5"	29'-8"	27'-9"	25'-6"	32'-9"	30'-8"	28'-2"
Snow 115%	25		10	23'-1"	21'-10"	20'-4"	27'-5"	25'-11"	24'-1"	31'-2"	29'-5"	27'-5"	34'-1"	32'-6"	30'-3"
	25		15	22'-0"	20'-8"	19'-2"	26'-1"	24'-7"	22'-9"	29'-8"	27'-11"	25'-11"	31'-10"	30'-11"	28'-7"
	30		10	22'-0"	20'-10"	19'-6"	26'-2"	24'-9"	23'-1"	29'-9"	28'-2"	26'-4"	31'-11"	31'-2"	29'-1"
	30		15	21'-1"	19'-11"	18'-6"	25'-1"	23'-8"	22'-0"	28'-1"	26'-11"	25'-0"	30'-0"	29'-4"	27'-7"
	40		10	20'-0"	19'-3"	18'-2"	23'-10"	22'-10"	21'-7"	26'-9"	26'-0"	24'-6"	28'-7"	28'-2"	27'-1"
	40		15	19'-9"	18'-8"	17'-5"	23'-4"	22'-2"	20'-8"	25'-5"	24'-11"	23'-6"	27'-2"	26'-8"	25'-11"
	50		10	18'-6"	17'-9"	16'-11"	22'-1"	21'-2"	20'-1"	24'-5"	24'-1"	22'-10"	26'-1"	25'-9"	25'-3"
	50		15	18'-6"	17'-8"	16'-6"	21'-5"	21'-0"	19'-8"	23'-5"	23'-0"	22'-4"	25'-0"	24'-7"	24'-0"
	19.2" o.c.		Non-Snow 125%	20	10	22'-10"	21'-6"	20'-0"	27'-1"	25'-7"	23'-9"	30'-10"	29'-1"	27'-0"	34'-0"
20		15		21'-7"	20'-3"	18'-9"	25'-8"	24'-1"	22'-3"	29'-2"	27'-5"	25'-4"	32'-3"	30'-3"	27'-11"
20		20		20'-7"	19'-3"	17'-9"	24'-6"	22'-11"	21'-1"	27'-10"	26'-1"	24'-0"	30'-2"	28'-9"	26'-6"
Snow 115%		25	10	21'-8"	20'-6"	19'-1"	25'-9"	24'-4"	22'-8"	29'-1"	27'-8"	25'-9"	31'-1"	30'-6"	28'-5"
		25	15	20'-8"	19'-5"	18'-0"	24'-6"	23'-1"	21'-5"	27'-2"	26'-3"	24'-4"	29'-0"	28'-3"	26'-11"
		30	10	20'-8"	19'-7"	18'-3"	24'-7"	23'-3"	21'-9"	27'-3"	26'-6"	24'-8"	29'-1"	28'-7"	27'-4"
		30	15	19'-10"	18'-9"	17'-5"	23'-6"	22'-3"	20'-8"	25'-7"	25'-0"	23'-6"	27'-5"	26'-9"	25'-11"
		40	10	18'-10"	18'-1"	17'-1"	22'-4"	21'-5"	20'-3"	24'-4"	24'-0"	23'-0"	26'-1"	25'-8"	25'-2"
		40	15	18'-6"	17'-6"	16'-4"	21'-3"	20'-10"	19'-5"	23'-2"	22'-9"	22'-1"	24'-9"	24'-4"	23'-8"
		50	10	17'-5"	16'-8"	15'-10"	20'-5"	19'-10"	18'-10"	22'-3"	22'-0"	21'-5"	23'-9"	23'-6"	23'-1"
		50	15	17'-3"	16'-7"	15'-6"	19'-7"	19'-3"	18'-5"	21'-4"	21'-0"	20'-6"	22'-10"	22'-2"	21'-2"
		24" o.c.	Non-Snow 125%	20	10	21'-1"	19'-11"	18'-6"	25'-1"	23'-8"	22'-0"	28'-6"	26'-11"	25'-0"	31'-4"
20	15			20'-0"	18'-9"	17'-4"	23'-9"	22'-4"	20'-7"	27'-0"	25'-5"	23'-5"	28'-11"	28'-0"	25'-11"
20	20			19'-1"	17'-10"	16'-5"	22'-8"	21'-3"	19'-6"	25'-3"	24'-2"	22'-2"	26'-11"	26'-0"	24'-6"
Snow 115%	25		10	20'-0"	18'-11"	17'-8"	23'-10"	22'-6"	21'-0"	26'-0"	25'-6"	23'-10"	27'-10"	27'-3"	26'-4"
	25		15	19'-1"	18'-0"	16'-8"	22'-3"	21'-5"	19'-10"	24'-3"	23'-7"	22'-6"	25'-11"	25'-3"	24'-4"
	30		10	19'-2"	18'-2"	16'-11"	22'-4"	21'-7"	20'-1"	24'-4"	23'-11"	22'-11"	26'-0"	25'-7"	24'-11"
	30		15	18'-4"	17'-4"	16'-1"	21'-0"	20'-6"	19'-1"	22'-10"	22'-4"	21'-7"	24'-5"	23'-11"	23'-1"
	40		10	17'-5"	16'-8"	15'-9"	20'-0"	19'-8"	18'-9"	21'-9"	21'-5"	21'-0"	23'-3"	22'-11"	22'-3"
	40		15	16'-9"	16'-2"	15'-1"	19'-0"	18'-7"	18'-0"	20'-8"	20'-4"	19'-3"	21'-7"	20'-9"	19'-8"
	50		10	16'-1"	15'-5"	14'-8"	18'-3"	18'-0"	17'-5"	19'-6"	19'-0"	18'-5"	19'-10"	19'-5"	18'-9"
	50		15	15'-5"	15'-2"	14'-4"	17'-3"	16'-8"	15'-11"	17'-11"	17'-4"	16'-6"	18'-3"	17'-8"	16'-10"

NOTES

- ▶ Table values
 - are limited by shear, moment, total load deflection equal to L/180 and live load deflection equal to L/240. Check the local building code for other deflection limits that may apply.
 - represent the most restrictive of simple or multiple span applications. Analyze multiple span joists with the BC Calc® software if the length of any span is less than half the length of an adjacent span.
 - assume minimum bearing lengths without web stiffeners for joist depths of 16" and less.
- ▶ This table was designed to apply to a broad range of applications. It may be possible to exceed the limitations of this table by analyzing a specific application with the BC Calc® software.
- ▶ Slope roof joists at least ¼:12 to minimize ponding.
- ▶ Allowable spans and loads shall be adjusted and checked for wind load as required by local building code.

Roof Span Tables

Maximum clear span in feet and inches, based on horizontal spans.

115% and 125% Load Duration

Condition			BCI® 60s 2.0 Joist									BCI® 90s 2.0 Joist									
			11 7/8"			14"			16"			11 7/8"			14"			16"			
O.C. Spacing and Load Duration	Live Load (psf)	Dead Load (psf)	4:12 or Less	4:12 to 8:12	8:12 to 12:12	4:12 or Less	4:12 to 8:12	8:12 to 12:12	4:12 or Less	4:12 to 8:12	8:12 to 12:12	4:12 or Less	4:12 to 8:12	8:12 to 12:12	4:12 or Less	4:12 to 8:2	8:12 to 12:12	4:12 or Less	4:12 to 8:12	8:12 to 12:12	
12" o.c.	Non-Snow 125%	20	10	34'-1"	32'-2"	29'-10"	38'-9"	36'-7"	33'-11"	42'-11"	40'-6"	37'-7"	39'-0"	36'-10"	34'-2"	44'-3"	41'-9"	38'-9"	49'-0"	46'-3"	42'-11"
		20	15	32'-4"	30'-4"	28'-0"	36'-9"	34'-6"	31'-10"	40'-8"	38'-3"	35'-3"	37'-0"	34'-9"	32'-1"	41'-11"	39'-4"	36'-4"	46'-5"	43'-7"	40'-3"
		20	20	30'-10"	28'-10"	26'-6"	35'-1"	32'-10"	30'-2"	38'-10"	36'-4"	33'-5"	35'-3"	33'-0"	30'-4"	39'-11"	37'-5"	34'-5"	44'-3"	41'-5"	38'-1"
	Snow 115%	25	10	32'-5"	30'-7"	28'-6"	36'-10"	34'-10"	32'-5"	40'-10"	38'-7"	35'-11"	37'-1"	35'-0"	32'-7"	42'-0"	39'-8"	36'-11"	46'-6"	44'-0"	40'-11"
		25	15	30'-11"	29'-1"	26'-11"	35'-2"	33'-1"	30'-7"	38'-11"	36'-8"	33'-11"	35'-4"	33'-3"	30'-10"	40'-1"	37'-9"	34'-11"	44'-4"	41'-9"	38'-8"
		30	10	31'-0"	29'-4"	27'-4"	35'-3"	33'-4"	31'-1"	39'-0"	36'-11"	34'-5"	35'-5"	33'-7"	31'-4"	40'-2"	38'-0"	35'-6"	44'-6"	42'-1"	39'-4"
		30	15	29'-8"	28'-0"	26'-0"	33'-9"	31'-10"	29'-7"	37'-5"	35'-3"	32'-9"	34'-0"	32'-1"	29'-9"	38'-6"	36'-4"	33'-9"	42'-8"	40'-3"	37'-4"
		40	10	28'-2"	27'-0"	25'-6"	32'-1"	30'-9"	29'-0"	35'-6"	34'-1"	32'-2"	32'-3"	30'-11"	29'-2"	36'-6"	35'-0"	33'-1"	40'-6"	38'-10"	36'-8"
		40	15	27'-9"	26'-3"	24'-6"	31'-7"	29'-10"	27'-10"	34'-11"	33'-1"	30'-10"	31'-9"	30'-0"	28'-0"	36'-0"	34'-0"	31'-9"	39'-10"	37'-9"	35'-2"
		50	10	26'-1"	25'-0"	23'-9"	29'-8"	28'-6"	27'-0"	32'-11"	31'-6"	29'-11"	29'-10"	28'-8"	27'-2"	33'-10"	32'-5"	30'-10"	37'-6"	35'-11"	34'-2"
50	15	26'-1"	24'-10"	23'-3"	29'-8"	28'-3"	26'-5"	32'-11"	31'-4"	29'-3"	29'-10"	28'-5"	26'-7"	33'-10"	32'-3"	30'-1"	37'-6"	35'-8"	33'-5"		
16" o.c.	Non-Snow 125%	20	10	30'-11"	29'-2"	27'-1"	35'-2"	33'-2"	30'-9"	38'-11"	36'-9"	34'-1"	35'-4"	33'-4"	31'-0"	40'-1"	37'-10"	35'-1"	44'-5"	41'-11"	38'-11"
		20	15	29'-3"	27'-6"	25'-5"	33'-4"	31'-3"	28'-10"	36'-11"	34'-8"	32'-0"	33'-6"	31'-6"	29'-1"	37'-11"	35'-8"	32'-11"	42'-0"	39'-6"	36'-6"
		20	20	27'-11"	26'-2"	24'-1"	31'-9"	29'-9"	27'-4"	35'-2"	32'-11"	30'-4"	31'-11"	29'-11"	27'-6"	36'-2"	33'-11"	31'-2"	40'-1"	37'-7"	34'-7"
	Snow 115%	25	10	29'-4"	27'-9"	25'-10"	33'-5"	31'-7"	29'-5"	37'-0"	34'-11"	32'-7"	33'-7"	31'-9"	29'-7"	38'-1"	36'-0"	33'-6"	42'-2"	39'-10"	37'-1"
		25	15	28'-0"	26'-4"	24'-5"	31'-10"	30'-0"	27'-9"	35'-3"	33'-2"	30'-9"	32'-0"	30'-2"	27'-11"	36'-3"	34'-2"	31'-8"	40'-2"	37'-10"	35'-1"
		30	10	28'-1"	26'-7"	24'-10"	31'-11"	30'-3"	28'-2"	35'-4"	33'-6"	31'-3"	32'-1"	30'-5"	28'-4"	36'-4"	34'-5"	32'-2"	40'-3"	38'-2"	35'-8"
		30	15	26'-11"	25'-5"	23'-7"	30'-7"	28'-10"	26'-10"	33'-11"	32'-0"	29'-8"	30'-9"	29'-0"	27'-0"	34'-10"	32'-11"	30'-7"	38'-7"	36'-5"	33'-10"
		40	10	25'-6"	24'-6"	23'-1"	29'-0"	27'-10"	26'-4"	32'-2"	30'-10"	29'-2"	29'-2"	28'-0"	26'-5"	33'-1"	31'-9"	30'-0"	36'-8"	35'-2"	33'-3"
		40	15	25'-1"	23'-9"	22'-2"	28'-7"	27'-1"	25'-3"	31'-8"	30'-0"	27'-11"	28'-9"	27'-2"	25'-4"	32'-7"	30'-10"	28'-9"	36'-1"	34'-2"	31'-10"
		50	10	23'-7"	22'-8"	21'-6"	26'-10"	25'-9"	24'-6"	29'-9"	28'-7"	27'-1"	27'-0"	25'-11"	24'-7"	30'-7"	29'-5"	27'-11"	33'-11"	32'-7"	30'-11"
50	15	23'-7"	22'-6"	21'-0"	26'-10"	25'-7"	23'-11"	28'-7"	27'-8"	26'-5"	27'-0"	25'-9"	24'-1"	30'-7"	29'-2"	27'-3"	33'-11"	32'-4"	30'-3"		
19.2" o.c.	Non-Snow 125%	20	10	29'-1"	27'-5"	25'-5"	33'-0"	31'-2"	28'-11"	36'-7"	34'-6"	32'-0"	33'-3"	31'-4"	29'-1"	37'-8"	35'-6"	33'-0"	41'-8"	39'-4"	36'-7"
		20	15	27'-6"	25'-10"	23'-10"	31'-3"	29'-5"	27'-1"	34'-8"	32'-7"	30'-1"	31'-5"	29'-7"	27'-3"	35'-8"	33'-6"	30'-11"	39'-6"	37'-1"	34'-3"
		20	20	26'-3"	24'-7"	22'-7"	29'-10"	27'-11"	25'-8"	33'-0"	30'-11"	28'-6"	30'-0"	28'-1"	25'-10"	34'-0"	31'-10"	29'-3"	37'-8"	35'-3"	32'-5"
	Snow 115%	25	10	27'-7"	26'-1"	24'-3"	31'-4"	29'-8"	27'-7"	34'-9"	32'-10"	30'-7"	31'-6"	29'-10"	27'-9"	35'-9"	33'-10"	31'-6"	39'-7"	37'-5"	34'-11"
		25	15	26'-3"	24'-9"	22'-11"	29'-11"	28'-2"	26'-1"	33'-1"	31'-2"	28'-11"	30'-1"	28'-4"	26'-3"	34'-1"	32'-1"	29'-9"	37'-9"	35'-7"	32'-11"
		30	10	26'-4"	25'-0"	23'-4"	30'-0"	28'-5"	26'-6"	33'-2"	31'-5"	29'-4"	30'-1"	28'-7"	26'-8"	34'-2"	32'-4"	30'-2"	37'-10"	35'-10"	33'-6"
		30	15	25'-3"	23'-10"	22'-2"	28'-9"	27'-1"	25'-2"	31'-10"	30'-0"	27'-11"	28'-10"	27'-3"	25'-4"	32'-9"	30'-11"	28'-8"	36'-3"	34'-3"	31'-10"
		40	10	24'-0"	23'-0"	21'-9"	27'-3"	26'-2"	24'-8"	30'-2"	29'-0"	27'-4"	27'-5"	26'-3"	24'-10"	31'-0"	29'-10"	28'-2"	34'-5"	33'-0"	31'-2"
		40	15	23'-7"	22'-4"	20'-10"	26'-10"	25'-5"	23'-8"	28'-1"	27'-0"	25'-7"	26'-11"	25'-6"	23'-10"	30'-7"	28'-11"	27'-0"	33'-10"	32'-1"	29'-11"
		50	10	22'-2"	21'-3"	20'-3"	25'-3"	24'-2"	23'-0"	25'-10"	25'-3"	24'-5"	25'-4"	24'-4"	23'-1"	28'-8"	27'-7"	26'-2"	31'-10"	30'-7"	29'-1"
50	15	22'-2"	21'-2"	19'-9"	23'-9"	23'-0"	21'-11"	23'-9"	23'-0"	21'-11"	25'-4"	24'-2"	22'-7"	28'-8"	27'-5"	25'-7"	29'-8"	28'-8"	27'-5"		
24" o.c.	Non-Snow 125%	20	10	26'-11"	25'-5"	23'-7"	30'-7"	28'-10"	26'-10"	33'-11"	32'-0"	29'-8"	30'-9"	29'-0"	27'-0"	34'-10"	32'-11"	30'-7"	38'-7"	36'-5"	33'-10"
		20	15	25'-6"	23'-11"	22'-1"	28'-11"	27'-2"	25'-2"	32'-1"	30'-2"	27'-10"	29'-1"	27'-4"	25'-3"	33'-0"	31'-0"	28'-8"	36'-7"	34'-4"	31'-9"
		20	20	24'-3"	22'-9"	20'-11"	27'-7"	25'-10"	23'-10"	30'-7"	28'-8"	26'-4"	27'-9"	26'-0"	23'-11"	31'-5"	29'-6"	27'-1"	34'-10"	32'-8"	30'-1"
	Snow 115%	25	10	25'-6"	24'-2"	22'-6"	29'-0"	27'-6"	25'-7"	32'-2"	30'-5"	28'-4"	29'-2"	27'-7"	25'-9"	33'-1"	31'-4"	29'-2"	36'-8"	34'-8"	32'-4"
		25	15	24'-4"	22'-11"	21'-3"	27'-8"	26'-1"	24'-2"	30'-8"	28'-11"	26'-9"	27'-10"	26'-3"	24'-4"	31'-6"	29'-9"	27'-6"	34'-11"	32'-11"	30'-6"
		30	10	24'-5"	23'-1"	21'-7"	27'-9"	26'-3"	24'-6"	30'-9"	29'-1"	27'-2"	27'-11"	26'-5"	24'-8"	31'-7"	29'-11"	28'-0"	35'-0"	33'-2"	31'-0"
		30	15	23'-4"	22'-1"	20'-6"	26'-7"	25'-1"	23'-4"	27'-4"	26'-1"	24'-5"	26'-9"	25'-3"	23'-5"	30'-3"	28'-7"	26'-7"	33'-7"	31'-8"	29'-5"
		40	10	22'-2"	21'-3"	20'-1"	24'-9"	24'-1"	22'-10"	24'-9"	24'-1"	23'-1"	25'-4"	24'-4"	23'-0"	28'-8"	27'-7"	26'-1"	30'-11"	30'-0"	28'-10"
		40	15	21'-10"	20'-8"	19'-3"	22'-5"	21'-6"	20'-5"	22'-5"	21'-6"	20'-5"	24'-11"	23'-7"	22'-0"	27'-9"	26'-8"	25'-0"	28'-0"	26'-11"	25'-6"
		50	10	20'-6"	19'-8"	18'-9"	20'-8"	20'-2"	19'-6"	20'-8"	20'-2"	19'-6"	23'-5"	22'-6"	21'-5"	25'-7"	24'-11"	24'-1"	25'-9"	25'-2"	24'-4"
50	15	19'-0"	18'-4"	17'-6"	19'-0"	18'-4"	17'-6"	19'-0"	18'-4"	17'-6"	23'-4"	22'-4"	20'-11"	23'-6"	22'-9"	21'-8"	23'-8"	22'-11"	21'-10"		

NOTES

► Table values

- are limited by shear, moment, total load deflection equal to L/180 and live load deflection equal to L/240. Check the local building code for other deflection limits that may apply.
- represent the most restrictive of simple or multiple span applications. Analyze multiple span joists with the BC Calc® software if the length of any span is less than half the length of an adjacent span.
- assume minimum bearing lengths without web stiffeners for joist depths of 16" and less.

► This table was designed to apply to a broad range of applications. It may be possible to exceed the limitations of this table by analyzing a specific application with the BC Calc® software.

► Slope roof joists at least 1/4:12 to minimize ponding.

► Allowable spans and loads shall be adjusted and checked for wind load as required by local building code.

Roof Load Tables

Allowable Uniform Roof Load in pounds per lineal foot (PLF)

115% and 125% Load Duration

Use of these tables should be limited to roof slopes of 3½:12 or less. For steeper slopes, see pages 15–18.

Span Length	BCI® 4500s 1.8 Joist											
	9½"			11⅞"			14"			16"		
	Total Load		Deflection	Total Load		Deflection	Total Load		Deflection	Total Load		Deflection
	Snow (115%)	Non-Snow (125%)	L/240	Snow (115%)	Non-Snow (125%)	L/240	Snow (115%)	Non-Snow (125%)	L/240	Snow (115%)	Non-Snow (125%)	L/240
6'	315	343	–	338	367	–	353	383	–	356	387	–
7'	270	294	–	289	315	–	302	329	–	305	332	–
8'	236	257	–	253	275	–	264	287	–	267	290	–
9'	210	228	–	225	245	–	235	255	–	237	258	–
10'	189	205	–	202	220	–	211	230	–	214	232	–
11'	172	187	–	184	200	–	192	209	–	194	211	–
12'	147	160	–	169	183	–	176	191	–	178	193	–
13'	125	136	–	156	169	–	162	177	–	164	179	–
14'	108	118	107	139	151	–	151	164	–	152	166	–
15'	94	102	88	121	131	–	141	153	–	142	155	–
16'	83	90	73	106	115	–	126	137	–	133	145	–
17'	73	80	61	94	102	–	111	121	–	125	136	–
18'	65	67	51	84	91	–	99	108	–	113	123	–
19'	58	58	44	75	82	73	89	97	–	102	111	–
20'	49	49	38	68	74	63	80	87	–	92	100	–
21'	43	43	33	61	67	54	73	79	–	83	90	–
22'				56	61	47	66	72	–	76	82	–
23'				51	54	42	61	66	–	69	75	–
24'				47	48	37	56	60	54	64	69	–
25'				43	43	32	51	56	48	59	64	–
26'							47	51	42	54	59	–
27'							44	48	38	50	54	–
28'							41	44	34	47	51	46
29'										43	47	41
30'										40	44	37

NOTES

- ▶ Total Load values are limited by shear, moment, or deflection equal to L/180.
- ▶ Deflection values are limited by live load deflection equal to L/240. Check the local building code for other deflection limits that may apply.
- ▶ Both the Total Load and Deflection columns must be checked. Where a deflection value is not shown, the total load value will control.
- ▶ Table values assume minimum bearing lengths without web stiffeners for joist depths of 16" and less.
- ▶ Slope roof joists at least ¼:12 to minimize ponding.
- ▶ Table values apply to either simple or multiple span joists. Span is measured center-to-center of the minimum required bearing length. Analyze multiple span joists with the BC Calc® software if the length of any span is less than half the length of an adjacent span.
- ▶ This table was designed to apply to a broad range of applications. It may be possible to exceed the limitations of this table by analyzing a specific application with the BC Calc® software.
- ▶ Allowable spans and loads shall be adjusted and checked for wind load as required by local building code.

Roof Load Tables

Allowable Uniform Roof Load in pounds per lineal foot (PLF)

115% and 125% Load Duration

Use of these tables should be limited to roof slopes of 3½:12 or less. For steeper slopes, see pages 15–18.

Span Length	BCI® 5000s 1.8 Joist								
	9½"			11⅞"			14"		
	Total Load		Deflection	Total Load		Deflection	Total Load		Deflection
	Snow (115%)	Non-Snow (125%)	L/240	Snow (115%)	Non-Snow (125%)	L/240	Snow (115%)	Non-Snow (125%)	L/240
6'	315	343	–	338	367	–	353	383	–
7'	270	294	–	289	315	–	302	329	–
8'	236	257	–	253	275	–	264	287	–
9'	210	228	–	225	245	–	235	255	–
10'	189	205	–	202	220	–	211	230	–
11'	172	187	–	184	200	–	192	209	–
12'	157	171	–	169	183	–	176	191	–
13'	145	158	–	156	169	–	162	177	–
14'	125	136	120	144	157	–	151	164	–
15'	109	118	98	135	147	–	141	153	–
16'	95	104	81	122	133	–	132	143	–
17'	85	89	68	108	118	–	124	135	–
18'	75	76	58	96	105	–	114	124	–
19'	65	65	49	87	94	82	103	112	–
20'	56	56	42	78	85	71	93	101	–
21'	48	48	37	71	77	61	84	91	–
22'	42	42	32	64	70	54	76	83	–
23'				59	62	47	70	76	68
24'				54	54	41	64	70	60
25'				48	48	37	59	64	54
26'				43	43	33	55	59	48
27'							51	55	43
28'							47	50	38

NOTES

- ▶ Total Load values are limited by shear, moment, or deflection equal to L/180.
- ▶ Deflection values are limited by live load deflection equal to L/240. Check the local building code for other deflection limits that may apply.
- ▶ Both the Total Load and Deflection columns must be checked. Where a deflection value is not shown, the total load value will control.
- ▶ Table values assume minimum bearing lengths without web stiffeners for joist depths of 16" and less.
- ▶ Slope roof joists at least ¼:12 to minimize ponding.
- ▶ Table values apply to either simple or multiple span joists. Span is measured center-to-center of the minimum required bearing length. Analyze multiple span joists with the BC Calc® software if the length of any span is less than half the length of an adjacent span.
- ▶ This table was designed to apply to a broad range of applications. It may be possible to exceed the limitations of this table by analyzing a specific application with the BC Calc® software.
- ▶ Allowable spans and loads shall be adjusted and checked for wind load as required by local building code.

Roof Load Tables

Allowable Uniform Roof Load in pounds per lineal foot (PLF)

115% and 125% Load Duration

Use of these tables should be limited to roof slopes of 3½:12 or less. For steeper slopes, see pages 15–18.

Span Length	BCI® 6000s 1.8 Joist											
	9½"			11⅞"			14"			16"		
	Total Load		Deflection	Total Load		Deflection	Total Load		Deflection	Total Load		Deflection
	Snow (115%)	Non-Snow (125%)	L/240	Snow (115%)	Non-Snow (125%)	L/240	Snow (115%)	Non-Snow (125%)	L/240	Snow (115%)	Non-Snow (125%)	L/240
6'	360	392	–	375	408	–	390	424	–	398	432	–
7'	309	336	–	322	350	–	334	364	–	341	371	–
8'	270	294	–	281	306	–	293	318	–	298	324	–
9'	240	261	–	250	272	–	260	283	–	265	288	–
10'	216	235	–	225	245	–	234	254	–	238	259	–
11'	196	213	–	204	222	–	213	231	–	217	236	–
12'	180	196	–	187	204	–	195	212	–	199	216	–
13'	166	180	–	173	188	–	180	196	–	183	199	–
14'	145	158	135	161	175	–	167	182	–	170	185	–
15'	126	137	111	150	163	–	156	169	–	159	173	–
16'	111	121	92	140	153	–	146	159	–	149	162	–
17'	98	101	78	126	137	–	137	149	–	140	152	–
18'	86	86	66	112	122	108	130	141	–	132	144	–
19'	74	74	56	101	110	92	120	130	–	125	136	–
20'	63	63	48	91	99	80	108	117	–	119	129	–
21'	55	55	42	83	90	69	98	107	–	112	122	–
22'	48	48	36	75	79	60	89	97	88	102	111	–
23'	42	42	32	69	70	53	82	89	78	93	101	–
24'				61	61	47	75	81	68	86	93	–
25'				54	54	42	69	75	61	79	86	–
26'				49	49	37	64	69	54	73	79	–
27'				43	43	33	59	63	48	67	73	65
28'							55	57	44	63	68	58

NOTES

- ▶ Total Load values are limited by shear, moment, or deflection equal to L/180.
- ▶ Deflection values are limited by live load deflection equal to L/240. Check the local building code for other deflection limits that may apply.
- ▶ Both the Total Load and Deflection columns must be checked. Where a deflection value is not shown, the total load value will control.
- ▶ Table values assume minimum bearing lengths without web stiffeners for joist depths of 16" and less.
- ▶ Slope roof joists at least ¼:12 to minimize ponding.
- ▶ Table values apply to either simple or multiple span joists. Span is measured center-to-center of the minimum required bearing length. Analyze multiple span joists with the BC Calc® software if the length of any span is less than half the length of an adjacent span.
- ▶ This table was designed to apply to a broad range of applications. It may be possible to exceed the limitations of this table by analyzing a specific application with the BC Calc® software.
- ▶ Allowable spans and loads shall be adjusted and checked for wind load as required by local building code.

Roof Load Tables

Allowable Uniform Roof Load in pounds per lineal foot (PLF)

115% and 125% Load Duration

Use of these tables should be limited to roof slopes of 3½:12 or less. For steeper slopes, see pages 15–18.

Span Length	BCI® 6500s 1.8 Joist											
	9½"			11⅞"			14"			16"		
	Total Load		Deflection	Total Load		Deflection	Total Load		Deflection	Total Load		Deflection
	Snow (115%)	Non-Snow (125%)	L/240	Snow (115%)	Non-Snow (125%)	L/240	Snow (115%)	Non-Snow (125%)	L/240	Snow (115%)	Non-Snow (125%)	L/240
6'	360	392	–	375	408	–	390	424	–	398	432	–
7'	309	336	–	322	350	–	334	364	–	341	371	–
8'	270	294	–	281	306	–	293	318	–	298	324	–
9'	240	261	–	250	272	–	260	283	–	265	288	–
10'	216	235	–	225	245	–	234	254	–	238	259	–
11'	196	213	–	204	222	–	213	231	–	217	236	–
12'	180	196	–	187	204	–	195	212	–	199	216	–
13'	166	180	–	173	188	–	180	196	–	183	199	–
14'	154	168	147	161	175	–	167	182	–	170	185	–
15'	140	152	121	150	163	–	156	169	–	159	173	–
16'	123	132	101	140	153	–	146	159	–	149	162	–
17'	109	111	85	132	144	–	137	149	–	140	152	–
18'	94	94	72	125	135	118	130	141	–	132	144	–
19'	80	80	61	112	122	101	123	134	–	125	136	–
20'	69	69	53	101	110	87	117	127	–	119	129	–
21'	60	60	46	91	99	76	108	118	–	113	123	–
22'	52	52	40	83	87	66	99	107	96	108	118	–
23'	46	46	35	76	76	58	90	98	84	103	112	–
24'	41	41	31	67	67	51	83	90	74	95	103	–
25'				60	60	45	76	83	66	87	95	–
26'				53	53	40	71	77	59	81	88	79
27'				47	47	36	65	69	53	75	81	71
28'				43	43	32	61	62	47	69	76	63
29'							56	56	43	65	70	57
30'							51	51	39	60	66	52
31'							46	46	35	57	62	47
32'							42	42	32	53	56	43
33'										50	51	39
34'										47	47	36
35'										43	43	33

NOTES

- ▶ Total Load values are limited by shear, moment, or deflection equal to L/180.
- ▶ Deflection values are limited by live load deflection equal to L/240. Check the local building code for other deflection limits that may apply.
- ▶ Both the Total Load and Deflection columns must be checked. Where a deflection value is not shown, the total load value will control.
- ▶ Table values assume minimum bearing lengths without web stiffeners for joist depths of 16" and less.
- ▶ Slope roof joists at least ¼:12 to minimize ponding.
- ▶ Table values apply to either simple or multiple span joists. Span is measured center-to-center of the minimum required bearing length. Analyze multiple span joists with the BC Calc® software if the length of any span is less than half the length of an adjacent span.
- ▶ This table was designed to apply to a broad range of applications. It may be possible to exceed the limitations of this table by analyzing a specific application with the BC Calc® software.
- ▶ Allowable spans and loads shall be adjusted and checked for wind load as required by local building code.

Roof Load Tables

Allowable Uniform Roof Load in pounds per lineal foot (PLF)

115% and 125% Load Duration

Use of these tables should be limited to roof slopes of 3½:12 or less. For steeper slopes, see pages 15–18.

Span Length	BCI® 60s 2.0 Joist									BCI® 90s 2.0 Joist								
	11⅞"			14"			16"			11⅞"			14"			16"		
	Total Load		Deflection	Total Load		Deflection	Total Load		Deflection	Total Load		Deflection	Total Load		Deflection	Total Load		Deflection
	Snow (115%)	Non-Snow (125%)	L/240	Snow (115%)	Non-Snow (125%)	L/240	Snow (115%)	Non-Snow (125%)	L/240	Snow (115%)	Non-Snow (125%)	L/240	Snow (115%)	Non-Snow (125%)	L/240	Snow (115%)	Non-Snow (125%)	L/240
6'	413	449	–	413	449	–	413	449	–	507	551	–	510	555	–	514	559	–
7'	354	385	–	354	385	–	354	385	–	434	472	–	437	476	–	441	479	–
8'	309	336	–	309	336	–	309	336	–	380	413	–	383	416	–	385	419	–
9'	275	299	–	275	299	–	275	299	–	338	367	–	340	370	–	343	372	–
10'	247	269	–	247	269	–	247	269	–	304	330	–	306	333	–	308	335	–
11'	225	245	–	225	245	–	225	245	–	276	300	–	278	302	–	280	305	–
12'	206	224	–	206	224	–	206	224	–	253	275	–	255	277	–	257	279	–
13'	190	207	–	190	207	–	190	207	–	234	254	–	235	256	–	237	258	–
14'	177	192	–	177	192	–	177	192	–	217	236	–	218	238	–	220	239	–
15'	165	179	–	165	179	–	165	179	–	202	220	–	204	222	–	205	223	–
16'	154	168	–	154	168	–	154	168	–	190	206	–	191	208	–	192	209	–
17'	145	158	–	145	158	–	145	158	–	178	194	–	180	196	–	181	197	–
18'	137	149	–	137	149	–	137	149	–	169	183	–	170	185	–	171	186	–
19'	130	141	123	130	141	–	130	141	–	160	174	–	161	175	–	162	176	–
20'	123	134	106	123	134	–	123	134	–	152	165	–	153	166	–	154	167	–
21'	118	121	92	118	128	–	118	128	–	144	157	134	145	158	–	147	159	–
22'	106	106	81	112	122	–	112	122	–	138	150	118	139	151	–	140	152	–
23'	93	93	71	107	117	103	107	117	–	132	136	104	133	144	–	134	145	–
24'	82	82	63	103	112	91	103	112	–	120	120	92	127	138	–	128	139	–
25'	73	73	56	99	106	81	99	107	–	107	107	82	122	133	117	123	134	–
26'	65	65	50	94	94	72	95	103	–	96	96	73	117	128	104	118	129	–
27'	58	58	44	85	85	65	91	99	87	86	86	65	113	123	94	114	124	–
28'	52	52	40	76	76	58	88	96	78	77	77	59	109	110	84	110	119	–
29'	47	47	36	69	69	52	85	92	71	70	70	53	100	100	76	106	115	102
30'	43	43	32	62	62	47	82	84	64	63	63	48	91	91	69	102	111	93
31'				56	56	43	76	76	58	57	57	44	82	82	63	99	108	85
32'				51	51	39	69	69	53	52	52	40	75	75	57	96	101	77
33'				47	47	36	63	63	48	48	48	36	69	69	52	92	92	71
34'				43	43	33	58	58	44	44	44	33	63	63	48	85	85	65
35'							53	53	41	40	40	31	58	58	44	78	78	59

NOTES

- ▶ Total Load values are limited by shear, moment, or deflection equal to L/180.
- ▶ Deflection values are limited by live load deflection equal to L/240. Check the local building code for other deflection limits that may apply.
- ▶ Both the Total Load and Deflection columns must be checked. Where a deflection value is not shown, the total load value will control.
- ▶ Table values assume minimum bearing lengths without web stiffeners for joist depths of 16" and less.
- ▶ Slope roof joists at least ¼:12 to minimize ponding.
- ▶ Table values apply to either simple or multiple span joists. Span is measured center-to-center of the minimum required bearing length. Analyze multiple span joists with the BC Calc® software if the length of any span is less than half the length of an adjacent span.
- ▶ This table was designed to apply to a broad range of applications. It may be possible to exceed the limitations of this table by analyzing a specific application with the BC Calc® software.
- ▶ Allowable spans and loads shall be adjusted and checked for wind load as required by local building code.

BCI Joist Design Properties

BCI® Joist Series	Joist Depth	Weight (PLF)	Moment (ft-lbs)	EI x 10 ⁶ (lb-in ²)	K x 10 ⁶ (lbs)	Shear (lbs)	End Reaction (lbs)				Intermediate Reaction (lbs)			
							1½" Bearing		3½" Bearing		3½" Bearing		5¼" Bearing	
							No WS ⁽¹⁾	WS ⁽²⁾	No WS ⁽¹⁾	WS ⁽²⁾	No WS ⁽¹⁾	WS ⁽²⁾	No WS ⁽¹⁾	WS ⁽²⁾
4500s 1.8	9½"	2.1	2,360	155	5	1,475	950	1,125	1,125	1,275	2,100	2,350	2,525	2,750
	11⅞"	2.4	3,025	260	6	1,625	950	1,425	1,425	1,475	2,250	2,850	2,525	3,000
	14"	2.7	3,585	380	8	1,825	950	1,525	1,450	1,725	2,350	3,050	2,525	3,200
	16"	3	4,090	515	9	1,975	950	1,625	1,475	1,975	2,400	3,200	2,525	3,350
5000s 1.8	9½"	2.3	2,725	175	5	1,475	950	1,125	1,125	1,275	2,100	2,350	2,525	2,750
	11⅞"	2.6	3,485	295	6	1,625	950	1,425	1,425	1,475	2,250	2,850	2,525	3,000
	14"	2.9	4,130	430	8	1,825	950	1,525	1,475	1,725	2,350	3,050	2,525	3,200
	16"	3.1	4,715	580	9	1,975	950	1,625	1,500	1,975	2,400	3,200	2,525	3,350
6000s 1.8	9½"	2.5	3,165	200	5	1,575	1,175	1,375	1,375	1,425	2,400	2,650	2,700	2,750
	11⅞"	2.8	4,060	335	6	1,675	1,175	1,425	1,425	1,475	2,500	2,850	2,900	3,000
	14"	3.1	4,815	490	8	1,925	1,175	1,525	1,525	1,725	2,600	3,150	2,925	3,200
	16"	3.3	5,495	660	9	2,175	1,175	1,625	1,550	1,975	2,650	3,350	2,950	3,350
6500s 1.8	9½"	2.7	3,505	220	5	1,575	1,175	1,375	1,375	1,425	2,400	2,650	2,700	2,750
	11⅞"	3	4,495	365	7	1,675	1,175	1,425	1,425	1,475	2,500	2,850	2,900	3,000
	14"	3.3	5,330	535	8	1,925	1,175	1,525	1,525	1,725	2,600	3,150	2,925	3,200
	16"	3.5	6,085	720	9	2,175	1,175	1,625	1,550	1,975	2,650	3,350	2,950	3,350
60s 2.0	11⅞"	3.2	6,235	450	7	1,675	1,175	1,425	1,425	1,475	2,750	2,850	3,200	3,250
	14"	3.5	7,440	660	8	1,925	1,175	1,525	1,525	1,725	2,750	3,450	3,200	3,650
	16"	3.8	8,520	895	9	2,175	1,175	1,625	1,550	1,975	2,750	3,650	3,200	3,750
90s 2.0	11⅞"	4.3	9,550	675	7	2,150	1,425	1,850	1,800	1,950	3,375	3,700	4,000	4,350
	14"	4.6	11,390	980	8	2,350	1,450	1,950	1,850	2,150	3,400	3,850	4,100	4,450
	16"	4.9	13,050	1,330	9	2,550	1,475	2,150	1,900	2,350	3,425	4,000	4,200	4,650

- (1) No web stiffeners required.
 (2) Web stiffeners required.

NOTES

- ▶ Moment, shear and reaction values based upon a load duration of 100% and may be adjusted for other load durations.
- ▶ Design values listed are applicable for Allowable Stress Design (ASD).
- ▶ No additional repetitive member increase allowed.

$$\Delta = \frac{5wl^4}{384EI} + \frac{wl^2}{K}$$

Δ = deflection (in) EI = bending stiffness (lb-in²)
 w = uniform load (lb/in) K = shear deformation coefficient (lb)
 l = clear span (in)

Code Evaluation Report: ICC-ES®/APA® ESR-1336 (IBC®, IRC®)

Closest Allowable Nail Spacing

Nail Size	All BCI® Joists			
	Nailing Perpendicular to Glue Line (Wide Face)		Nailing Parallel to Glue Line (Narrow Face)	
	O.C. Spacing	End of Joist	O.C. Spacing	End of Joist
8d Box (0.113"ø x 2.5")	2"	1½"	4"	1½"
8d Common (0.131"ø x 2.5")	2"	1½"	4"	3"
10d & 12d Box (0.128"ø x 3", 3.25")	2"	1½"	4"	3"
16d Box (0.135"ø x 3.5")	2"	1½"	4"	3"
10d & 12d Common and 16d Sinkers (0.148"ø x 3", 3.25")	3"	2"	6"	4"
16d Common (0.162"ø x 3.5")	3"	2"	6"	4"

NOTES

- ▶ If more than one row of nails is used, the rows must be offset at least ½".
- ▶ Connectors that mount to sides of flanges (such as Simpson Strong-Tie A35) may only be used on BCI® 60s and 90s joist flanges. Use nails as specified by Simpson Strong-Tie; do not attach connectors on both sides of a flange at the same location.

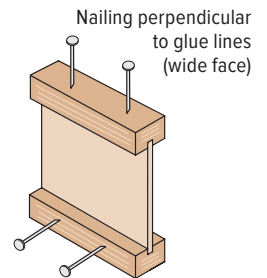

Nailing perpendicular to glue lines (wide face)
 Nailing parallel to glue lines (narrow face)

BCI® Diaphragm Table⁽¹⁾

BCI® Series	Diaphragm Capacity (lb/ft) ^{(2) (3)}	
	Unblocked	Blocked
4500s, 5000s	As permitted for 2x framing in building code	320 lb/ft for 6" o.c. nailing at panel edges 425 lb/ft for 4" o.c. nailing, staggered, at panel edges
6000s, 6500s	As permitted for 3x framing in building code	360 lb/ft for 6" o.c. nailing at panel edges 480 lb/ft for 4" o.c. nailing, staggered at panel edges
60s, 90s	As permitted for 3x framing in building code	As permitted for 3x framing in building code not to exceed 690 lb/ft.

NOTES

- (1) See ICC-ES®/APA® ESR-1336, Table 7.
- (2) As noted in table, BCI® joists may be substituted for solid sawn framing in horizontal wood diaphragms as shown in ANSI/AWC SDPWS, Tables 4.2A and 4.2C (referenced in IBC).
- (3) Diaphragm nailing shall not exceed the limits of BCI® joist closest allowable nail spacing.

Rim Board Details and Properties

Rim Board Product Profiles

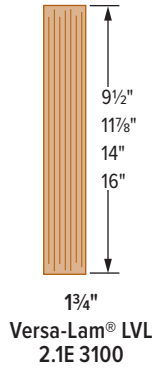
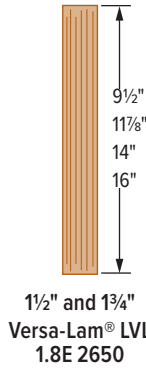
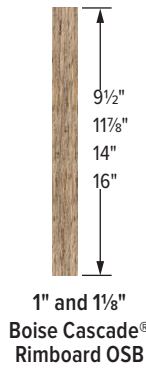

F07

Perpendicular

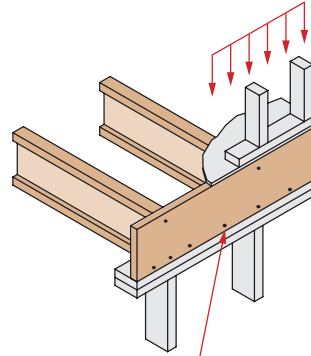

- ▶ Rim board: min. 8d nails at 6" o.c. per IRC. Connection per design professional of record's specification for shear transfer.
- ▶ See table for vertical load capacity

F07A

Parallel

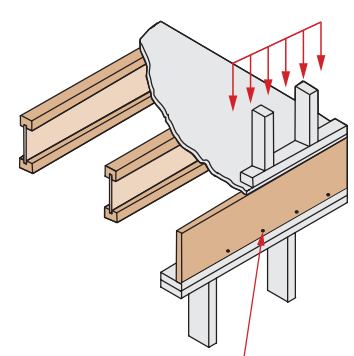

- ▶ Rim board: min. 8d nails at 6" o.c. per IRC. Connection per design professional of record's specification for shear transfer.
- ▶ See table for vertical load capacity

F56

Rim Board with Ledger Attachment

BCI® joists perpendicular or parallel to rim

Exterior wall sheathing maximum thickness 1 5/32"

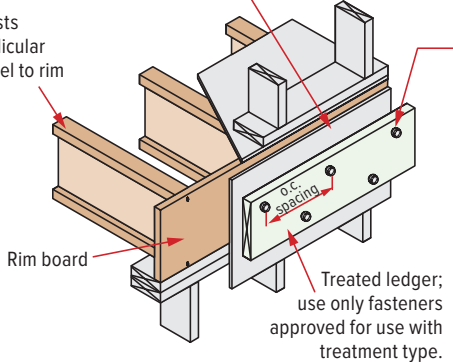

1/2" diameter through bolts (ASTM A307 Grades A & B, SAE J429 Grades 1 or 2, or higher with washer and nuts) or 1/2" diameter lag screws (full penetration), staggered.

Minimum connection for 40/10 psf deck loading:

Deck Joist Length	Connection
12'-0" and less	2 rows 1/2" bolts or lag screws, 24" o.c. (300 PLF max.)
12'-1" to 18'-0"	2 rows 1/2" bolts or lag screws, 16" o.c. (450 PLF max.)

For snow loads greater than 40 psf and/or dead loads greater than 10 psf, size connection per max. PLF values shown above.

NOTES

- ▶ Design of moisture control by others (only structural components shown above).
- ▶ For information on deck lateral load connections per IRC section R507.2.3, contact Boise Cascade EWP Engineering.
- ▶ For use of proprietary screws to attach ledger, consult screw manufacturer literature.
- ▶ For further information on residential deck design, see AWC DCA 6 *Prescriptive Residential Wood Deck Construction Guide*.

Rim Board Properties

Product	Vertical Load Capacity		Maximum Floor Diaphragm Lateral Capacity (lb/ft)	Specific Gravity for Lateral Nail Design	Allowable Design Values			
	Uniform (PLF)	Point (lb)			Flexural Stress (lb/in ²)	Modulus of Elasticity—True (lb/in ²)	Horizontal Shear (lb/in ²)	Compression Perpendicular to Grain (lb/in ²)
1" Boise Cascade® Rimboard OSB (C2) ⁽¹⁾	3,300	3,500	180	0.5	Limited span capabilities, see Note 1			
1 1/8" Boise Cascade® Rimboard OSB (C1) ⁽¹⁾	4,850	3,500	180					
1 1/2" and 1 3/4" Versa-Lam® LVL 1.8E 2650 ⁽²⁾	4,250	3,700	Permitted per building code for all nominal 2" thick framing blocked and unblocked diaphragms (4" nail spacing and greater)		2,650	1,800,000	285	750
1 3/4" Versa-Lam® LVL 2.1E 3100 ⁽²⁾	5,700	4,300			3,100	2,100,000	285	750

(1) Rim board grades C1 and C2 per APA Form W345 U.S. Edition *APA Performance-Rated Rim Boards*.

(2) See ICC-ES/APA ESR-1040 for more information.

Closest Allowable Nail Spacing (Narrow Face)

Nail Size	Boise Cascade® Rimboard OSB ⁽¹⁾		Versa-Lam® LVL Rim Board ⁽²⁾	
	1"	1 1/8"	1 1/2"	1 3/4"
8d box (0.113"ø x 2.5")	3"	3"	3"	2"
8d common (0.131"ø x 2.5")	3"	3"	3"	3"
10d and 12d box (0.128"ø x 3", 3.25")	See publication listed in note (1) for additional nailing information.		3"	3"
16d box (0.135"ø x 3.5")			3"/5"	3"/5"
10d and 12d common and 16d sinker (0.148"ø x 3", 3.25")			4"/6"	4"/6"
16d common (0.162"ø x 3.5")			6"/8"	6"/8"

Red numbers indicate different nail spacing for Versa-Lam® LVL manufactured in Thorsby, AL.

(1) See *Performance Rated Rim Boards*, APA Form #W345 for more product information.

(2) See ICC-ES/APA ESR-1040 for more information.

Versa-Lam LVL Product Profiles

When you specify headers and beams made of Versa-Lam® laminated veneer lumber (LVL), you are building quality into your design. They are excellent for floor and roof framing supports and as headers for doors, windows, and garage doors. Versa-Lam® LVL can even be used in column applications. Because they have no camber, Versa-Lam® LVL products provide flatter, quieter floors—which helps ensure happier customers and significantly fewer builder call backs.



Versa-Lam® LVL products shall be installed in dry-use applications only, per their respective ICC-ES/APA ESR evaluation reports.

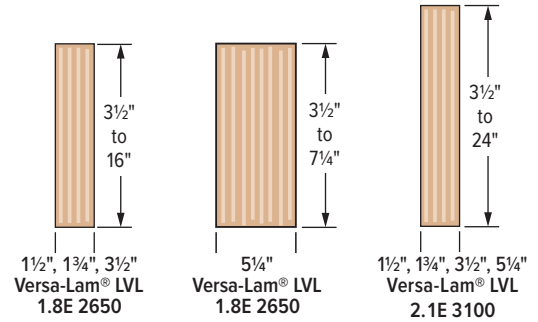

Some products may not be available in all markets. Contact your Boise Cascade EWP representative for availability.

Architectural Specifications

Scope — This work includes the complete furnishing and installation of all Versa-Lam® LVL beams as shown on the drawings, herein specified and necessary to complete the work.

Materials — Southern Pine or Douglas fir veneers, laminated in a press with all grain parallel with the length of the member. Glues used in lamination are phenol formaldehyde and isocyanate exterior-type adhesives which comply with ASTM D2559.

Design — Versa-Lam® LVL beams shall be sized and detailed to fit the dimensions and loads indicated on the plans. All designs shall be in accordance with allowable values developed in accordance with ASTM D5456 and listed in

the governing code evaluation service's report and section properties based upon standard engineering principles. Verification of design of the Versa-Lam® LVL beams by complete calculations shall be available upon request.

Drawings — Additional drawings showing layout and detail necessary for determining fit and placement in the buildings are (are not) to be provided by the supplier.

Fabrication — Versa-Lam® LVL beams shall be manufactured in a plant evaluated for fabrication by the governing code evaluation service and under the supervision of a third-party inspection agency listed by the corresponding evaluation service.

Storage and Installation — Versa-Lam® LVL beams, if stored prior to erection, shall be stored on stickers spaced a maximum of 15 ft. apart. Beams shall be stored on a dry, level surface and protected from the weather. They shall be handled with care so they are not damaged.

Versa-Lam® LVL beams are to be installed in accordance with the plans and Boise Cascade EWP's Installation Guide. Temporary construction loads which cause stresses beyond design limits are not permitted. Erection bracing shall be provided to assure adequate lateral support for the individual beams and the entire system until the sheathing material has been applied.

Codes — Versa-Lam® LVL beams shall be evaluated by a model code evaluation service.

Versa-Lam LVL Allowable Holes

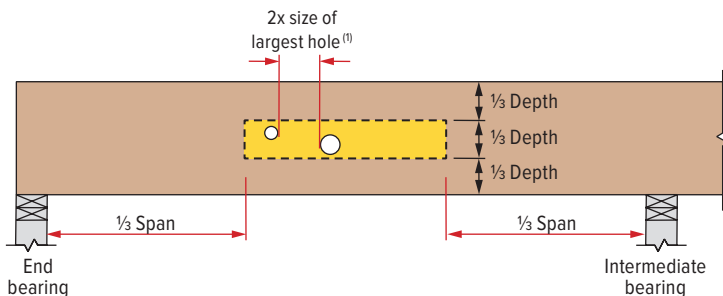

Allowable Round Holes

Table valid only for beams supporting uniform load.

Beam Depth	Max. Hole Diameter
5 1/2" to less than 7 1/4"	3/4"
7 1/4" to less than 9 1/4"	1"
9 1/4" to less than 18"	2"
18" to less than 24"	3"
24"	4"

NOTES

(1) The horizontal distance between adjacent holes must be at least two times the diameter of the larger hole. This restriction also applies to the location of holes relative to bolt holes in multiple ply beams. Holes shall not be stacked vertically.

- ▶ Round holes may be drilled or cut with a hole saw anywhere within the shaded area of the beam.
- ▶ Square and rectangular holes are not permitted.
- ▶ Do not drill more than three access holes in any four foot long section of beam.
- ▶ These limitations apply to holes drilled for plumbing or wiring access only. The size and location of holes drilled for fasteners are governed by the provisions of the *National Design Specification® for Wood Construction*.
- ▶ Beams deflect under load. Size holes to provide clearance where required.
- ▶ Allowable Round Holes table at left is valid for beams supporting uniform load only. For beams supporting concentrated loads or beams with larger holes, use BC Calc® software or contact Boise Cascade EWP Engineering.

Versa-Lam LVL Beam Details

<p>Bearing at Concrete/Masonry Walls</p> <p>1/2" air space required between concrete and wood</p> <p>B01 Provide moisture barrier and lateral restraint at bearing</p>	<p>Bearing for Door or Window Header</p> <p>Strap per code if top plate is not continuous over header.</p> <p>Trimmer studs provide bearing across full width of beam.</p> <p>B02</p>	<p>Beam to Beam Connector</p> <p>Verify hanger capacity with hanger manufacturer</p> <p>B03</p>	<p>Bearing at Column</p> <p>Column connector per design profession of record</p> <p>Versa-Lam® LVL column</p> <p>B04</p>
<p>Slope Seat Cut</p> <p>Sloped seat cut. Not to exceed inside face of bearing</p> <p>Blocking not shown for clarity</p> <p>B06</p>	<p>Bevel Cut</p> <p>DO NOT bevel cut Versa-Lam LVL beyond inside face of wall without approval from Boise Cascade EWP Engineering or BC Calc software analysis.</p> <p>B07</p>	<p>Beam to Concrete/Masonry Walls</p> <p>Wood top plate must be flush with inside of wall</p> <p>Hanger</p> <p>Moisture barrier between concrete and wood</p> <p>B08</p>	<p>Bearing Framing into Wall</p> <p>Strap per code if top plate is not continuous</p> <p>B09</p>

NOTES

- ▶ Minimum of 1/2" air space between beam and wall pocket or adequate barrier must be provided between beam and concrete/masonry.
- ▶ Adequate bearing shall be provided. If not shown on plans, please refer to load tables on pages 28–30 of this guide.
- ▶ Versa-Lam® LVL beams are intended for interior applications only and should be kept as dry as possible during construction.
- ▶ Continuous lateral support of top of beam shall be provided (side or top bearing framing).

Versa-Lam LVL Beam Multiple Member Connections

Side-Loaded Applications — Maximum uniform side load (PLF)

Number of Plies	Nailed ⁽³⁾		1/2" Dia. Through Bolt ⁽¹⁾			5/8" Dia. Through Bolt ⁽¹⁾		
	2 Rows 16d Sinkers @ 12" o.c.	3 Rows 16d Sinkers @ 12" o.c.	2 Rows @ 24" o.c. Staggered	2 Rows @ 12" o.c. Staggered	2 Rows @ 6" o.c. Staggered	2 Rows @ 24" o.c. Staggered	2 Rows @ 12" o.c. Staggered	2 Rows @ 6" o.c. Staggered
1 3/4" Versa-Lam® LVL (Depths of 18" and less)								
2	470	705	505	1,010	2,020	560	1,120	2,245
3 ⁽²⁾	350	525	375	755	1,515	420	840	1,685
4 ⁽⁴⁾	Use bolt schedule		335	670	1,345	370	745	1,495
3 1/2" Versa-Lam® LVL								
2 ⁽⁴⁾	Use bolt schedule		855	1,715	N/A	1,125	2,250	N/A
Number of Plies	Nailed ⁽³⁾		1/2" Dia. Through Bolt ⁽¹⁾			5/8" Dia. Through Bolt ⁽¹⁾		
	3 Rows 16d Sinkers @ 12" o.c.	4 Rows 16d Sinkers @ 12" o.c.	3 Rows @ 24" o.c. 8" Staggered	3 Rows @ 18" o.c. 6" Staggered	3 Rows @ 12" o.c. 4" Staggered	3 Rows @ 24" o.c. 8" Staggered	3 Rows @ 18" o.c. 6" Staggered	3 Rows @ 12" o.c. 4" Staggered
1 3/4" Versa-Lam® LVL (Depths of 24" and less)								
2	705	940	755	1,010	1,515	840	1,120	1,685
3 ⁽²⁾	525	705	565	755	1,135	630	840	1,260
4 ⁽⁴⁾	Use bolt schedule		505	670	1,010	560	745	1,120

Top-Loaded Applications — For top-loaded beams and beams with side loads less than those shown in table above.

Plies	Depth	Number of Rows	Fastening ⁽¹⁾⁽³⁾	Maximum Uniform Load From One Side
Two 1 3/4" plies	11 7/8" and less	2	16d box/sinker nails @ 12" o.c.	400 PLF
	14"–18"	3		600 PLF
	24"	4		800 PLF
Three 1 3/4" plies ⁽²⁾	11 7/8" and less	2		300 PLF
	14"–18"	3		450 PLF
	24"	4		600 PLF
Four 1 3/4" plies	18" and less	2	1/2" bolts @ 24" o.c., staggered	335 PLF
	24"	3	1/2" bolts @ 24" o.c., staggered every 8"	505 PLF
Two 3 1/2" plies	18" and less	2	1/2" bolts @ 24" o.c., staggered	855 PLF
	20"–24"	3	1/2" bolts @ 24" o.c., staggered every 8"	1,285 PLF

- (1) Design values apply to common bolts that conform to ANSI/ASME standard B18.21-1981 (ASTM A307 Grades A&B, SAE J429 Grades 1 or 2, or higher). A washer not less than a standard cut washer shall be between the wood and the bolt head and between the wood and the nut. The distance from the edge of the beam to the bolt holes must be at least 2" for 1/2" bolts and 2 1/2" for 5/8" bolts. Bolt holes shall be the same diameter as the bolt.
- (2) The nail schedules shown apply to both sides of a 3-ply beam.
- (3) 16d box nails = 0.135" diameter x 3.5" length, 16d sinker nails = 0.148" diameter x 3.25" length.
- (4) 7" wide beams must be top-loaded or loaded from both sides (lesser side shall be no less than 25% of opposite side).

NOTES

- ▶ Beams wider than 7" must be designed by the engineer of record.
- ▶ All values in these tables may be increased by 15% for snow-load roofs and by 25% for non-snow load roofs where the building code allows.
- ▶ Use allowable load tables or BC Calc® software to size beams.
- ▶ An equivalent specific gravity of 0.5 may be used when designing specific connections with Versa-Lam® LVL.
- ▶ Connection values are based upon the NDS, 2018 Edition.
- ▶ FastenMaster TrussLOK®, Simpson Strong-Tie SDW or SDS, and MiTek WS screws may also be used to connect multiple member Versa-Lam® LVL beams. Contact Boise Cascade EWP Engineering for more information.

Designing Connections for Multiple-Ply Versa-Lam® LVL Beams

When using multiple ply Versa-Lam® LVL beams to create a wider member, the connection of the plies is as critical as determining the beam size. When side loaded beams are not connected properly, the inside plies do not support their share of the load and thus the load-carrying capacity of the full member decreases significantly.

The following example shows how to size and connect a multiple-ply Versa-Lam® LVL floor beam.

Given: Beam with a 16'-0" span (shown above) supports a residential floor load (40 psf live load, 10 psf dead load). Beam depth is limited to 14".

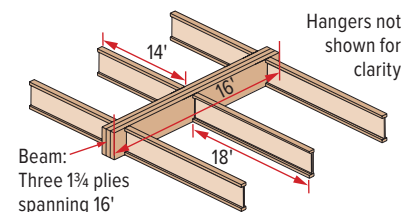

Find: A beam of multiple 1 3/4" plies of Versa-Lam® LVL that can support the design loads, plus the beam's proper connection schedule.

1. Calculate tributary width and load the beam is supporting:
 $14'/2 + 18'/2 = 16$ ft. tributary width
 Live Load: 40 psf x 16 ft. = **640 PLF**
 Dead Load: 10 psf x 16 ft. = **160 PLF**
 Total Load: 640 PLF + 160 PLF = **800 PLF**
2. Use PLF table on page 28 or BC Calc® software to size the beam.
 A 3-ply Versa-Lam® LVL 1 3/4" x 14" beam will adequately support the calculated design load.
3. Calculate the maximum PLF load from longest side (18' in this case).
 Max. Side Load = (18'/2) x (40 + 10 psf) = 450 PLF
4. See the Side-Loaded Applications table (at left) for 1 3/4" Versa-Lam® LVL, 3 plies.
5. The proper connection schedule must have a capacity greater than the maximum side load:

Nailed: 3 rows 16d sinkers at 12" o.c.: **525 PLF is greater than 450 PLF OK**
Bolts: 1/2" diameter 2 rows at 12" staggered: **755 PLF is greater than 450 PLF OK**

Versa-Lam LVL Beam Floor Load Table

Table Key: Top value = Allowable Total Load (PLF)
 Middle value = Allowable Live Load (PLF)
 Bottom value = Min. Required Bearing Length (inches) at End/Intermediate supports

Versa-Lam® LVL 2.1E 3100
(100% Load Duration)

Beam Span	1 3/4" Versa-Lam® LVL				3 1/2" Versa-Lam® LVL 2-Ply 1 3/4" or Single 3 1/2"						5 1/4" Versa-Lam® LVL 3-Ply 1 3/4" or Single 5 1/4"						7" Versa-Lam® LVL 4-Ply 1 3/4" or 2-Ply 3 1/2"					
	Beam Depth				Beam Depth						Beam Depth						Beam Depth					
	7 1/4"	9 1/2"	11 7/8"	14"	7 1/4"	9 1/2"	11 7/8"	14"	16"	18"	9 1/2"	11 7/8"	14"	16"	18"	20"	11 7/8"	14"	16"	18"	20"	24"
6'	763	1,063	1,424	1,795	1,525	2,126	2,849	3,590	4,387	4,794	3,189	4,273	5,384	6,580	7,191	7,188	5,697	7,179	8,773	9,588	9,584	9,576
	693	-	-	-	1,385	-	-	-	-	-	-	-	-	-	-	-	-	-	-	-	-	-
7'	1,844	2,461	3,308	4,103	1,844	2,461	3,308	4,103	5,126	5,513	2,461	3,308	4,103	5,126	5,513	5,513	3,308	4,103	5,126	5,513	5,513	5,513
	636	877	1,160	1,444	1,271	1,753	2,321	2,888	3,482	4,107	2,630	3,481	4,331	5,223	6,160	6,157	4,641	5,775	6,964	8,213	8,209	8,201
8'	462	746	979	1,207	924	1,492	1,957	2,414	2,886	3,402	2,237	2,936	3,622	4,328	5,103	5,384	3,914	4,829	5,771	6,803	7,178	7,170
	310	660	-	-	621	1,321	-	-	-	-	1,981	-	-	-	-	-	-	-	-	-	-	-
9'	1,513	2,357	3,175	3,793	1,513	2,357	3,175	3,793	4,411	5,213	2,357	3,175	3,793	4,411	5,213	5,513	3,175	3,793	4,411	5,213	5,513	5,513
	329	649	846	1,037	658	1,297	1,692	2,074	2,463	2,884	1,946	2,537	3,111	3,694	4,325	4,782	3,383	4,148	4,926	5,767	6,376	6,368
10'	222	477	-	-	444	954	-	-	-	-	1,431	-	-	-	-	-	-	-	-	-	-	-
	1,513	2,256	2,973	3,689	1,513	2,256	2,973	3,689	4,310	5,124	2,256	2,973	3,689	4,310	5,124	5,513	2,973	3,689	4,310	5,124	5,513	5,513
11'	242	527	745	909	484	1,055	1,489	1,817	2,148	2,502	1,582	2,234	2,726	3,222	3,753	4,301	2,978	3,635	4,296	5,003	5,734	5,726
	164	355	660	-	327	710	1,321	-	-	-	1,065	1,981	-	-	-	-	2,642	-	-	-	-	-
12'	1,513	2,511	2,971	3,587	1,513	2,511	2,971	3,587	4,103	4,812	2,511	2,971	3,587	4,103	4,812	5,513	2,971	3,587	4,103	4,812	5,513	5,513
	183	401	665	808	365	803	1,330	1,617	1,904	2,209	1,204	1,995	2,425	2,856	3,313	3,800	2,659	3,233	3,807	4,417	5,067	5,201
13'	124	271	508	798	248	541	1,015	1,595	-	-	812	1,523	2,393	-	-	-	2,031	3,190	-	-	-	-
	1,513	1,743	2,817	3,485	1,513	1,743	2,817	3,485	4,101	4,711	1,743	2,817	3,485	4,101	4,711	5,413	2,817	3,485	4,101	4,711	5,413	5,513
14'	91	312	585	728	282	623	1,170	1,456	1,709	1,977	935	1,755	2,184	2,564	2,965	3,390	2,340	2,912	3,418	3,953	4,519	4,764
	96	211	398	629	193	422	796	1,258	-	-	633	1,194	1,887	-	-	-	1,592	2,517	-	-	-	-
15'	1,513	1,536	2,768	3,484	1,513	1,536	2,768	3,484	3,999	4,611	1,536	2,768	3,484	3,999	4,611	5,213	2,768	3,484	3,999	4,611	5,213	5,513
	111	246	470	662	221	493	941	1,324	1,550	1,789	739	1,411	1,986	2,326	2,683	3,059	1,881	2,647	3,101	3,577	4,078	4,394
16'	76	168	318	504	152	335	635	1,009	1,456	-	503	953	1,513	2,185	-	-	1,270	2,017	2,913	-	-	-
	1,513	1,531	2,459	3,383	1,513	1,531	2,459	3,383	3,997	4,511	1,531	2,459	3,383	3,997	4,511	5,127	2,459	3,383	3,997	4,511	5,127	5,513
17'	88	198	380	585	176	396	759	1,171	1,418	1,633	594	1,139	1,756	2,128	2,449	2,786	1,519	2,342	2,837	3,265	3,715	4,076
	61	135	257	410	123	270	514	820	1,189	-	405	771	1,230	1,783	-	-	1,029	1,640	2,378	-	-	-
18'	1,513	1,533	2,151	3,279	1,513	1,533	2,151	3,279	3,896	4,411	1,533	2,151	3,279	3,896	4,411	5,125	2,151	3,279	3,896	4,411	5,125	5,513
	71	161	310	499	143	322	621	998	1,307	1,502	483	931	1,497	1,960	2,253	2,558	1,242	1,997	2,614	3,003	3,410	3,801
19'	50	111	211	338	100	221	422	675	982	1,359	332	633	1,013	1,473	2,039	-	844	1,350	1,964	2,718	-	-
	1,513	1,533	1,845	2,972	1,513	1,533	1,845	2,972	3,895	4,310	1,533	1,845	2,972	3,895	4,310	4,912	1,845	2,972	3,895	4,310	4,912	5,513
20'	58	132	257	414	117	265	514	829	1,151	1,390	397	770	1,243	1,727	2,085	2,364	1,027	1,658	2,303	2,780	3,151	3,561
	41	92	175	281	83	183	350	562	820	1,138	275	526	843	1,230	1,707	2,279	701	1,124	1,640	2,277	3,038	-
21'	1,513	1,533	1,614	2,664	1,513	1,533	1,614	2,664	3,689	4,310	1,533	1,614	2,664	3,689	4,310	4,912	1,614	2,664	3,689	4,310	4,912	5,513
	110	214	347	96	220	429	695	1,018	1,274	330	643	1,042	1,527	1,911	2,196	858	1,389	2,036	2,547	2,929	3,348	-
22'	77	147	236	69	153	294	473	691	962	230	441	709	1,037	1,443	1,931	588	945	1,382	1,924	2,575	-	-
	1,513	1,536	2,357	3,175	1,513	1,536	2,357	3,175	4,210	5,125	1,536	2,357	3,175	4,210	5,125	5,812	1,536	2,357	3,175	4,210	5,812	5,513
23'	92	181	294	80	185	361	587	865	1,134	277	542	881	1,298	1,701	2,051	723	1,175	1,731	2,268	2,735	3,160	-
	65	124	201	58	130	249	401	588	820	194	373	602	882	1,230	1,650	498	802	1,176	1,640	2,200	-	-
24'	1,513	1,532	2,152	3,276	1,513	1,532	2,152	3,276	4,999	5,513	1,532	2,152	3,276	4,999	5,513	6,115	1,532	2,152	3,276	4,999	5,513	5,513
	78	153	250	67	156	307	500	739	1,016	234	460	751	1,109	1,524	1,863	614	1,001	1,479	2,032	2,484	2,991	-
25'	55	106	172	50	110	213	343	504	704	166	319	515	756	1,056	1,420	425	686	1,008	1,408	1,893	-	-
	1,513	1,533	1,947	2,972	1,513	1,533	1,947	2,972	3,794	4,310	1,533	1,947	2,972	3,794	4,310	4,912	1,533	1,947	2,972	3,794	4,912	5,513
26'	66	131	215	57	133	263	429	636	895	199	394	644	954	1,343	1,678	525	859	1,272	1,790	2,237	2,839	-
	47	92	148	43	95	183	296	435	609	142	275	444	652	913	1,230	366	592	870	1,218	1,640	2,718	-
27'	1,513	1,533	1,742	2,562	1,513	1,533	1,742	2,562	3,587	4,310	1,533	1,742	2,562	3,587	4,310	5,125	1,533	1,742	2,562	3,587	4,310	5,513
	98	161	236	98	196	322	479	678	147	293	483	719	1,016	1,379	391	644	959	1,355	1,839	2,576	-	-
28'	69	112	172	72	138	224	330	464	107	208	336	496	696	940	277	448	661	928	1,253	2,091	-	-
	1,513	1,535	2,357	3,175	1,513	1,535	2,357	3,175	4,210	5,125	1,535	2,357	3,175	4,210	5,125	5,812	1,535	2,357	3,175	4,210	5,812	5,513
29'	74	123	201	58	107	174	257	361	83	161	261	385	542	733	214	348	513	722	978	1,640	-	
	1,513	1,533	1,845	2,972	1,513	1,533	1,845	2,972	3,895	4,310	1,533	1,845	2,972	3,895	4,310	4,912	1,533	1,845	2,972	3,895	4,912	5,513
30'	57	96	156	44	85	137	203	286	65	127	206	305	430	583	169	275	407	573	777	1,308	-	
	1,513	1,533	1,947	2,972	1,513	1,533	1,947	2,972	3,895	4,310	1,533	1,947	2,972	3,895	4,310	4,912	1,533	1,947	2,972	3,895	4,912	5,513
31'	76	155	229	64	135	227	344	492	675	180	303	458	656	900	1,541	-	-	-	-	-	-	-
	55	110	164	231	53	102	166	245	346	470	136	221	327	462	627	1,060	-	-	-	-	-	-
32'	1,513	1,533	1,845	2,972	1,513	1,533	1,845	2,972	3,895	4,310	1,533	1,845	2,972	3,895	4,310	4,912	1,533	1,845	2,972	3,895	4,912	5,513
	60	121	184	265	50	106	181	276	397	547	142	242	368	530	729	1,256	-	-	-	-	-	-
33'	45	90	134	189	43	83	135	200	283	385	111	180	267	378	513	870	-	-	-	-	-	-
	1,513	1,533	1,947	2,972	1,513	1,533	1,947	2,972	3,895	4,310	1,533	1,947	2,972	3,895	4,310	4,912	1,533	1,947	2,972	3,895	4,912	5,513

Versa-Lam LVL Beam Snow Roof Load Table

Table Key: Top value = Allowable Total Load (PLF)
 Middle value = Allowable Live Load (PLF)
 Bottom value = Min. Required Bearing Length (inches) at End/Intermediate supports

Versa-Lam® LVL 2.1E 3100
Snow (115%) Load Duration

Beam Span	1 3/4" Versa-Lam® LVL				3 1/2" Versa-Lam® LVL 2-Ply 1 3/4" or Single 3 1/2"						5 1/4" Versa-Lam® LVL 3-Ply 1 3/4" or Single 5 1/4"						7" Versa-Lam® LVL 4-Ply 1 3/4" or 2-Ply 3 1/2"					
	Beam Depth				Beam Depth						Beam Depth						Beam Depth					
	7 1/4"	9 1/2"	11 7/8"	14"	7 1/4"	9 1/2"	11 7/8"	14"	16"	18"	9 1/2"	11 7/8"	14"	16"	18"	20"	11 7/8"	14"	16"	18"	20"	24"
6'	878	1,223	1,639	2,065	1,755	2,446	3,278	4,130	4,796	4,794	3,669	4,917	6,195	7,194	7,191	7,188	6,556	8,260	9,592	9,588	9,584	9,576
	-	-	-	-	-	-	-	-	-	-	-	-	-	-	-	-	-	-	-	-	-	-
7'	731	1,009	1,335	1,661	1,463	2,018	2,670	3,323	4,007	4,107	3,027	4,006	4,984	6,010	6,160	6,157	5,341	6,646	8,013	8,213	8,209	8,201
	678	-	-	-	1,357	-	-	-	-	-	-	-	-	-	-	-	-	-	-	-	-	-
8'	598	858	1,126	1,389	1,197	1,717	2,252	2,779	3,321	3,591	2,575	3,379	4,168	4,981	5,387	5,384	4,505	5,558	6,642	7,182	7,178	7,170
	466	-	-	-	931	-	-	-	-	-	-	-	-	-	-	-	-	-	-	-	-	-
9'	440	747	974	1,194	880	1,493	1,947	2,387	2,835	3,190	2,240	2,921	3,581	4,252	4,785	4,782	3,894	4,774	5,670	6,380	6,376	6,368
	333	715	-	-	665	1,431	-	-	-	-	2,146	-	-	-	-	-	-	-	-	-	-	-
10'	324	637	857	1,046	648	1,274	1,714	2,092	2,472	2,869	1,912	2,571	3,138	3,709	4,304	4,301	3,429	4,184	4,945	5,738	5,734	5,726
	246	532	-	-	491	1,065	-	-	-	-	1,597	-	-	-	-	-	-	-	-	-	-	-
11'	245	526	765	931	489	1,052	1,531	1,861	2,192	2,543	1,577	2,296	2,792	3,288	3,814	3,907	3,062	3,723	4,383	5,085	5,209	5,201
	186	406	762	-	372	812	1,523	-	-	-	1,218	2,285	-	-	-	-	3,046	-	-	-	-	-
12'	189	417	674	838	378	834	1,347	1,676	1,968	2,276	1,252	2,021	2,514	2,952	3,414	3,579	2,694	3,353	3,936	4,552	4,772	4,764
	144	317	597	-	289	633	1,194	-	-	-	950	1,791	-	-	-	-	2,389	-	-	-	-	-
13'	149	330	573	762	297	660	1,146	1,524	1,785	2,060	991	1,719	2,287	2,678	3,089	3,301	2,292	3,049	3,571	4,119	4,402	4,394
	114	251	476	756	229	503	953	1,513	-	-	754	1,429	2,269	-	-	-	1,905	3,026	-	-	-	-
14'	119	265	493	674	238	531	987	1,349	1,634	1,880	796	1,480	2,023	2,450	2,821	3,063	1,973	2,697	3,267	3,761	4,084	4,076
	92	203	386	615	184	405	771	1,230	-	-	608	1,157	1,845	-	-	-	1,543	2,460	-	-	-	-
15'	96	216	416	586	193	432	832	1,173	1,505	1,730	649	1,248	1,759	2,258	2,595	2,857	1,664	2,346	3,011	3,459	3,809	3,801
	75	166	317	506	150	332	633	1,013	1,473	-	497	950	1,519	2,210	-	-	1,266	2,025	2,946	-	-	-
16'	79	178	344	515	158	356	689	1,029	1,327	1,601	535	1,033	1,544	1,990	2,402	2,677	1,377	2,058	2,653	3,202	3,569	3,561
	62	137	263	421	124	275	526	843	1,230	-	412	788	1,264	1,845	-	-	1,051	1,686	2,460	-	-	-
17'	65	148	288	455	131	297	576	910	1,173	1,468	445	864	1,365	1,760	2,201	2,517	1,152	1,820	2,346	2,935	3,356	3,348
	52	115	220	354	104	230	441	709	1,037	1,443	345	661	1,063	1,555	2,165	-	882	1,418	2,074	2,886	-	-
18'	55	125	243	394	109	249	486	788	1,045	1,307	374	729	1,182	1,567	1,961	2,364	972	1,576	2,089	2,614	3,151	3,160
	44	97	187	301	87	194	373	602	882	1,230	291	560	902	1,322	1,845	-	747	1,203	1,763	2,460	-	-
19'	46	106	207	336	92	211	413	672	936	1,171	317	620	1,008	1,404	1,757	2,147	827	1,344	1,872	2,342	2,862	2,991
	37	83	160	257	74	166	319	515	756	1,056	249	479	772	1,133	1,584	2,130	638	1,029	1,511	2,112	2,839	-
20'	30	62	122	194	62	138	254	413	612	843	214	412	666	975	1,370	1,845	549	887	1,305	1,827	2,460	-
	20	42	84	136	62	138	254	413	612	843	214	412	666	975	1,370	1,845	549	887	1,305	1,827	2,460	-
21'	27	56	112	184	56	124	228	373	559	790	193	373	559	832	1,132	1,513	459	727	1,041	1,414	1,880	-
	22	45	90	145	56	124	228	373	559	790	193	373	559	832	1,132	1,513	459	727	1,041	1,414	1,880	-
22'	24	49	98	157	51	114	218	353	529	760	182	353	529	802	1,082	1,463	428	686	999	1,372	1,846	-
	25	51	102	167	51	114	218	353	529	760	182	353	529	802	1,082	1,463	428	686	999	1,372	1,846	-
24'	21	42	84	136	46	102	194	319	478	696	171	331	497	745	1,015	1,386	396	634	951	1,322	1,796	-
	22	45	90	145	46	102	194	319	478	696	171	331	497	745	1,015	1,386	396	634	951	1,322	1,796	-
26'	19	38	76	129	41	82	164	273	409	614	159	309	463	695	927	1,236	336	560	840	1,120	1,490	-
	18	36	72	123	41	82	164	273	409	614	159	309	463	695	927	1,236	336	560	840	1,120	1,490	-
28'	16	32	64	106	36	72	144	240	360	540	144	288	432	648	864	1,152	288	480	720	960	1,280	-
	15	30	60	100	36	72	144	240	360	540	144	288	432	648	864	1,152	288	480	720	960	1,280	-
30'	14	28	56	90	33	66	132	228	342	513	132	264	396	594	792	1,056	264	440	660	880	1,160	-
	13	26	52	84	33	66	132	228	342	513	132	264	396	594	792	1,056	264	440	660	880	1,160	-

- ▶ Total Load values are limited by shear, moment or deflection equal to L/180. Total Load values are the capacity of the beam in addition to its own weight.
- ▶ Live Load values are limited by deflection equal to L/240. Check the local building code for other deflection limits that may apply. Flat and low slope roofs may require more restrictive deflection limits, consult project's design professional of record.
- ▶ Where a Live Load value is not shown, the Total Load value will control.
- ▶ Table values represent the most restrictive of simple or multiple span applications. Span is measured center-to-center of the supports. Analyze multiple span beams with BC Calc® software if the length of any span is less than half the length of an adjacent span.
- ▶ Table values assume that lateral support is provided at each support and continuously along the top edge and applicable compression edges of the beam.

- ▶ Table values for Minimum Required Bearing Lengths are based on the allowable compression design value perpendicular to grain for the beam and the Total Load value shown. Other design considerations, such as a weaker support material, may warrant longer bearing lengths. Table values assume that support is provided across the full width of the beam.
- ▶ For 2-ply, 3-ply or 4-ply beams; double, triple or quadruple allowable total load and allowable live load values. Minimum required bearing lengths remain the same for any number of plies.
- ▶ 1 3/4" members deeper than 14" are to be used as multiple-member beams only. It may be possible to exceed this limitation by analyzing a specific, properly braced application using BC Calc® software.
- ▶ This table was designed to apply to a broad range of applications. It may be possible to exceed the limitations of this table by analyzing a specific application with BC Calc® software.

Versa-Lam LVL Beam Non-Snow Roof Load Table

Table Key: Top value = Allowable Total Load (PLF)
 Middle value = Allowable Live Load (PLF)
 Bottom value = Min. Required Bearing Length (inches) at End/Intermediate supports

**Versa-Lam® LVL 2.1E 3100
 Non-Snow (125%) Load Duration**

Beam Span	1 3/4" Versa-Lam® LVL				3 1/2" Versa-Lam® LVL 2-Ply 1 3/4" or Single 3 1/2"						5 1/4" Versa-Lam® LVL 3-Ply 1 3/4" or Single 5 1/4"						7" Versa-Lam® LVL 4-Ply 1 3/4" or 2-Ply 3 1/2"					
	Beam Depth				Beam Depth						Beam Depth						Beam Depth					
	7 1/4"	9 1/2"	11 7/8"	14"	7 1/4"	9 1/2"	11 7/8"	14"	16"	18"	9 1/2"	11 7/8"	14"	16"	18"	20"	11 7/8"	14"	16"	18"	20"	24"
6'	954	1,330	1,782	2,245	1,908	2,660	3,564	4,491	4,796	4,794	3,990	5,346	6,736	7,194	7,191	7,188	7,128	8,981	9,592	9,588	9,584	9,576
	-	-	-	-	-	-	-	-	-	-	-	-	-	-	-	-	-	-	-	-	-	-
7'	2.2/5.5	3.1/7.6	4.1/10.2	5.1/12.9	2.2/5.5	3.1/7.6	4.1/10.2	5.1/12.9	5.5/13.8	5.5/13.8	3.1/7.6	4.1/10.2	5.1/12.9	5.5/13.8	5.5/13.8	5.5/13.8	4.1/10.2	5.1/12.9	5.5/13.8	5.5/13.8	5.5/13.8	5.5/13.8
	795	1,097	1,452	1,807	1,591	2,194	2,904	3,613	4,109	4,107	3,291	4,356	5,420	6,163	6,160	6,157	5,807	7,226	8,217	8,213	8,209	8,201
8'	678	-	-	-	1,357	-	-	-	-	-	-	-	-	-	-	-	-	-	-	-	-	-
	2.1/5.3	2.9/7.3	3.9/9.7	4.8/12.1	2.1/5.3	2.9/7.3	3.9/9.7	4.8/12.1	5.5/13.8	5.5/13.8	2.9/7.3	3.9/9.7	4.8/12.1	5.5/13.8	5.5/13.8	5.5/13.8	3.9/9.7	4.8/12.1	5.5/13.8	5.5/13.8	5.5/13.8	5.5/13.8
9'	617	933	1,225	1,511	1,235	1,867	2,449	3,022	3,593	3,591	2,800	3,674	4,532	5,390	5,387	5,384	4,899	6,043	7,186	7,182	7,178	7,170
	466	-	-	-	931	-	-	-	-	-	-	-	-	-	-	-	-	-	-	-	-	-
10'	1.9/4.7	2.9/7.1	3.8/9.4	4.6/11.6	1.9/4.7	2.9/7.1	3.8/9.4	4.6/11.6	5.5/13.8	5.5/13.8	2.9/7.1	3.8/9.4	4.6/11.6	5.5/13.8	5.5/13.8	5.5/13.8	3.8/9.4	4.6/11.6	5.5/13.8	5.5/13.8	5.5/13.8	5.5/13.8
	440	812	1,059	1,298	880	1,624	2,117	2,596	3,083	3,190	2,436	3,176	3,894	4,624	4,785	4,782	4,235	5,192	6,166	6,380	6,376	6,368
11'	333	715	-	-	665	1,431	-	-	-	-	2,146	-	-	-	-	-	-	-	-	-	-	-
	1.5/3.8	2.8/7.7	3.7/9.1	4.5/11.2	1.5/3.8	2.8/7.7	3.7/9.1	4.5/11.2	5.3/13.3	5.5/13.8	3.7/9.1	4.5/11.2	5.3/13.3	5.5/13.8	5.5/13.8	5.5/13.8	3.7/9.1	4.5/11.2	5.3/13.3	5.5/13.8	5.5/13.8	5.5/13.8
12'	324	693	932	1,138	648	1,386	1,864	2,275	2,689	2,869	2,079	2,797	3,413	4,033	4,304	4,301	3,729	4,550	5,378	5,738	5,734	5,726
	246	532	-	-	491	1,065	-	-	-	-	1,597	-	-	-	-	-	-	-	-	-	-	-
13'	1.5/3.1	2.7/6.6	3.6/8.9	4.4/10.9	1.5/3.1	2.7/6.6	3.6/8.9	4.4/10.9	5.2/12.9	5.5/13.8	2.7/6.6	3.6/8.9	4.4/10.9	5.2/12.9	5.5/13.8	5.5/13.8	3.6/8.9	4.4/10.9	5.2/12.9	5.5/13.8	5.5/13.8	5.5/13.8
	245	537	833	1,012	489	1,073	1,665	2,024	2,384	2,607	1,610	2,498	3,037	3,576	3,910	3,907	3,330	4,049	4,767	5,213	5,209	5,201
14'	186	406	762	-	372	812	1,523	-	-	-	1,218	2,285	-	-	-	-	3,046	-	-	-	-	-
	1.5/3	2.3/5.7	3.5/8.8	4.3/10.7	1.5/3	2.3/5.7	3.5/8.8	4.3/10.7	5/12.6	5.5/13.8	2.3/5.7	3.5/8.8	4.3/10.7	5/12.6	5.5/13.8	5.5/13.8	3.5/8.8	4.3/10.7	5/12.6	5.5/13.8	5.5/13.8	5.5/13.8
15'	189	417	733	912	378	834	1,465	1,823	2,141	2,388	1,252	2,198	2,735	3,211	3,582	3,579	2,931	3,647	4,281	4,776	4,772	4,764
	144	317	597	-	289	633	1,194	-	-	-	950	1,791	-	-	-	-	2,389	-	-	-	-	-
16'	1.5/3	1.9/4.8	3.4/8.4	4.2/10.5	1.5/3	1.9/4.8	3.4/8.4	4.2/10.5	4.9/12.3	5.5/13.8	1.9/4.8	3.4/8.4	4.2/10.5	4.9/12.3	5.5/13.8	5.5/13.8	3.4/8.4	4.2/10.5	4.9/12.3	5.5/13.8	5.5/13.8	5.5/13.8
	149	330	623	829	297	660	1,247	1,658	1,942	2,203	991	1,870	2,487	2,913	3,304	3,301	2,494	3,316	3,884	4,406	4,402	4,394
17'	114	251	476	756	229	503	953	1,513	-	-	754	1,429	2,269	-	-	-	1,905	3,026	-	-	-	-
	1.5/3	1.7/4.1	3.1/7.8	4.1/10.4	1.5/3	1.7/4.1	3.1/7.8	4.1/10.4	4.8/12.1	5.5/13.8	1.7/4.1	3.1/7.8	4.1/10.4	4.8/12.1	5.5/13.8	5.5/13.8	3.1/7.8	4.1/10.4	4.8/12.1	5.5/13.8	5.5/13.8	5.5/13.8
18'	119	265	508	734	238	531	1,017	1,467	1,777	2,044	796	1,525	2,201	2,666	3,066	3,063	2,033	2,934	3,554	4,088	4,084	4,076
	92	203	386	615	184	405	771	1,230	-	-	608	1,157	1,845	-	-	-	1,543	2,460	-	-	-	-
19'	1.5/3	1.5/3.6	2.7/6.9	4/9.9	1.5/3	1.5/3.6	2.7/6.9	4/9.9	4.8/12	5.5/13.8	1.5/3.6	2.7/6.9	4/9.9	4.8/12	5.5/13.8	5.5/13.8	2.7/6.9	4/9.9	4.8/12	5.5/13.8	5.5/13.8	5.5/13.8
	96	216	416	638	193	432	832	1,276	1,638	1,882	649	1,248	1,914	2,456	2,823	2,857	1,664	2,552	3,275	3,763	3,809	3,801
20'	75	166	317	506	150	332	633	1,013	1,473	-	497	950	1,519	2,210	-	-	1,266	20,25	2,946	-	-	-
	1.5/3	1.5/3.2	2.4/6	3.7/9.2	1.5/3	1.5/3.2	2.4/6	3.7/9.2	4.7/11.8	5.4/13.6	1.5/3.2	2.4/6	3.7/9.2	4.7/11.8	5.4/13.6	5.5/13.8	2.4/6	3.7/9.2	4.7/11.8	5.4/13.6	5.5/13.8	5.5/13.8
21'	79	178	344	555	158	356	689	1,110	1,443	1,742	535	1,033	1,665	2,165	2,613	2,677	1,377	2,220	2,887	3,484	3,569	3,561
	62	137	263	421	124	275	526	843	1,230	1,707	412	788	1,264	1,845	2,561	-	1,051	1,686	2,460	3,415	-	-
22'	1.5/3	1.5/3	2.1/5.3	3.4/8.6	1.5/3	1.5/3	2.1/5.3	3.4/8.6	4.4/11.1	5.4/13.4	1.5/3	2.1/5.3	3.4/8.6	4.4/11.1	5.4/13.4	5.5/13.8	2.1/5.3	3.4/8.6	4.4/11.1	5.4/13.4	5.5/13.8	5.5/13.8
	65	148	288	466	131	297	576	931	1,277	1,597	445	864	1,397	1,915	2,395	2,517	1,152	1,862	2,553	3,193	3,356	3,348
23'	52	115	220	354	104	230	441	709	1,037	1,443	345	661	1,063	1,555	2,165	-	882	1,418	2,074	2,886	-	-
	1.5/3	1.5/3	1.9/4.8	3.1/7.7	1.5/3	1.5/3	1.9/4.8	3.1/7.7	4.2/10.5	5.2/13.1	1.5/3	1.9/4.8	3.1/7.7	4.2/10.5	5.2/13.1	5.5/13.8	1.9/4.8	3.1/7.7	4.2/10.5	5.2/13.1	5.5/13.8	5.5/13.8
24'	55	125	243	394	109	249	486	788	1,137	1,422	374	729	1,182	1,705	2,133	2,376	972	1,576	2,274	2,845	3,168	3,160
	44	97	187	301	87	194	373	602	882	1,230	291	560	902	1,322	1,845	-	747	1,203	1,763	2,460	-	-
25'	1.5/3	1.5/3	1.7/4.3	2.8/6.9	1.5/3	1.5/3	1.7/4.3	2.8/6.9	4/9.9	4.9/12.3	1.5/3	1.7/4.3	2.8/6.9	4/9.9	4.9/12.3	5.5/13.8	1.7/4.3	2.8/6.9	4/9.9	4.9/12.3	5.5/13.8	5.5/13.8
	46	106	207	336	92	211	413	672	991	1,275	317	620	1,008	1,487	1,912	2,249	827	1,344	1,983	2,549	2,999	2,991
26'	37	83	160	257	74	166	319	515	756	1,056	249	479	772	1,133	1,584	2,130	638	1,029	1,511	2,112	2,839	-
	1.5/3	1.5/3	1.5/3.8	2.5/6.2	1.5/3	1.5/3	1.5/3.8	2.5/6.2	3.6/9.1	4.7/11.7	1.5/3	1.5/3.8	2.5/6.2	3.6/9.1	4.7/11.7	5.5/13.8	1.5/3.8	2.5/6.2	3.6/9.1	4.7/11.7	5.5/13.8	5.5/13.8
27'	39	90	177	289	78	180	354	577	854	1,149	270	531	866	1,280	1,723	2,105	708	1,155	1,707	2,297	2,807	2,839
	32	71	137	222	64	142	275	444	652	913	214	412	666	979	1,370	1,845	549	887	1,305	1,827	2,460	-
28'	1.5/3	1.5/3	1.5/3.5	2.3/5.6	1.5/3	1.5/3	1.5/3.5	2.3/5.6	3.3/8.3	4.4/11.1	1.5/3	1.5/3.5	2.3/5.6	3.3/8.3	4.4/11.1	5.4/13.6	1.5/3.5	2.3/5.6	3.3/8.3	4.4/11.1	5.4/13.6	5.5/13.8
	67	132	217	357	134	265	434	645	909	1,200	397	651	967	1,364	1,735	2,105	529	868	1,289	1,819	2,313	2,576
29'	54	104	168	257	48	107	208	336	496	696	161	311	504	743	1,044	1,410	415	672	991	1,392	1,880	-
	1.5/3	1.5/3	1.9/4.7	1.5/3	1.5/3	1.5/3	1.9/4.7	2.8/6.9	3.9/9.7	4.9/12.3	1.5/3	1.5/3	1.9/4.7	2.8/6.9	3.9/9.7	4.9/12.3	1.5/3	1.9/4.7	2.8/6.9	3.9/9.7	4.9/12.3	5.5/13.8
30'	51	101	167	257	42	101	202	333	497	704	152	303	500	746	1,056	1,436	404	667	994	1,408	1,915	2,357
	42	80	130	217	37	83	161	261	385	542	125	241	391	578	813	1,100	321	521	770	1,083	1,467	-
31'	1.5/3	1.5/3	1.6/4	1.5/3	1.5/3	1.5/3	1.6/4	2.3/5.9	3.3/8.3	4.5/11.2	1.5/3	1.5/3	1.6/4	2.3/5.9	3.3/8.3	4.5/11.2	1.5/3	1.6/4	2.3/5.9	3.3/8.3	4.5/11.2	5.5/13.8
	33	79	130	217	78	157	261	390	555	781	116	236	391	585	832	1,135	314	521	781	1,109	1,513	2,172
32'	39	63	103																			

Versa-Lam LVL Beam Allowable Nailing

Closest Allowable Nail Spacing

Nail Size	Nailing Parallel to Glue Lines (Narrow Face) ⁽¹⁾						Nailing Perpendicular to Glue Lines (Wide Face)	
	Versa-Lam [®] LVL						All Versa-Lam [®] LVL Products	
	1½"		1¾"		3½" and wider		O.C.	End
	O.C.	End	O.C.	End	O.C.	End	O.C.	End
8d Box (0.113"ø x 2.5")	3"	1½"	2"	1"	2"	½"	2"	1"
8d Common (0.131"ø x 2.5")	3"	2"	3"	2"	2"	1"	2"	1"
10d and 12d Box (0.128"ø x 3", 3.25")	3"	2"	3"	2"	2"	1"	2"	1"
16d Box (0.135"ø x 3.5")	3"/5"	2"/2½"	3"/5"	2"/2½"	2"/3"	1"/2½"	2"	2"
10d and 12d Common and 16d Sinker (0.148"ø x 3", 3.25")	4"/6"	3"	4"/6"	3"	2"/4"	2"/3"	2"	2"
16d Common (0.162"ø x 3.5")	6"/8"	4"	6"/8"	3"/4"	2"/4"	2"/3"	2"/3"	2"/2½"

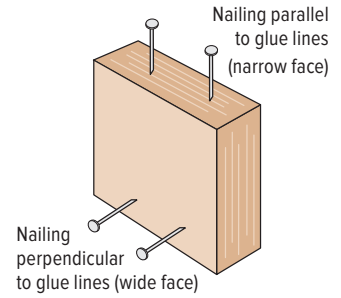

Red numbers indicate different nail spacing for Versa-Lam[®] LVL manufactured in Thorsby, AL.

(1) For 1¾" thickness and greater, two rows of nails (such as for a metal strap) are allowed (use ½" minimum offset between rows and stagger nails).

► Offset and stagger nail rows from floor sheathing and wall sole plate.

► Simpson Strong-Tie A35 and LPT4 connectors may be attached to the side of Versa-Lam[®] LVL. Use nails as specified by Simpson Strong-Tie.

Versa-Lam LVL Beam Design Values

Grade	Width	Depth	Weight (lb/ft)	Allowable Shear (lb)	Allowable Moment (ft-lb)	Moment of Inertia (in ⁴)
Versa-Stud [®] 1.8E 2650	1½"	3½"	1.5	998	776	5.4
		5½"	2.4	1,568	1,821	20.8
		7¼"	3.2	2,066	3,069	47.6
Versa-Lam [®] LVL 2.1E 3100	1¾"	3½"	1.8	1,164	1,058	6.3
		5½"	2.8	1,829	2,486	24.3
		7¼"	3.7	2,411	4,189	55.6
		9¼"	4.7	3,076	6,636	115.4
		9½"	4.8	3,159	6,979	125.0
		11¼"	5.7	3,741	9,605	207.6
		11⅞"	6.0	3,948	10,638	244.2
		14"	7.1	4,655	14,517	400.2
		16"	8.1	5,320	18,682	597.3
		18"	9.1	5,985	23,337	850.5
		24"	12.2	7,980	40,183	2,016.0
		Versa-Lam [®] LVL 2.1E 3100	3½"	5½"	5.6	3,658
7¼"	7.4			4,821	8,377	111.1
9¼"	9.4			6,151	13,272	230.8
9½"	9.6			6,318	13,958	250.1
11¼"	11.4			7,481	19,210	415.3
11⅞"	12.1			7,897	21,275	488.4
14"	14.2			9,310	29,035	800.3
16"	16.2			10,640	37,364	1,194.7
18"	18.3			11,970	46,674	1,701.0
20"	20.3			13,300	56,952	2,333.3

Grade	Width	Depth	Weight (lb/ft)	Allowable Shear (lb)	Allowable Moment (ft-lb)	Moment of Inertia (in ⁴)
Versa-Lam [®] LVL 2.1E 3100	5¼"	5¼"	8.0	5,237	6,830	63.3
		5½"	8.4	5,486	7,457	72.8
		7¼"	11.0	7,232	12,566	166.7
		9¼"	14.1	9,227	19,908	346.3
		9½"	14.5	9,476	20,937	375.1
		11¼"	17.1	11,222	28,814	622.9
		11⅞"	18.1	11,845	31,913	732.6
		14"	21.3	13,965	43,552	1,200.5
		16"	24.4	15,960	56,046	1,792.0
		18"	27.4	17,955	70,011	2,551.5
		20"	30.4	19,950	85,428	3,500.0
		24"	36.5	23,940	120,549	6,048.0
	7"	9¼"	16.6	12,303	26,544	461.7
		9½"	17.1	12,635	27,916	500.1
		11¼"	20.2	14,963	38,419	830.6
		11⅞"	21.4	15,794	42,550	976.8
		14"	25.2	18,620	58,069	1,600.7
		16"	28.8	21,280	74,728	2,389.3
		18"	32.4	23,940	93,348	3,402.0
		20"	36.0	26,600	113,904	4,666.7
		24"	43.2	31,920	160,732	8,064.0

Versa-Lam LVL Beam Allowable Stress Values

Design Property	Grade	Modulus of Elasticity True (Shear-Free) E (x 10 ⁶ psi) ⁽¹⁾⁽⁷⁾	Modulus of Elasticity Apparent E (x 10 ⁶ psi) ⁽¹⁾	Modulus of Elasticity for Stability E _{min} (x 10 ⁶ psi) ⁽¹⁾⁽⁸⁾	Bending F _b (psi) ⁽²⁾⁽³⁾	Horizontal Shear F _v (psi) ⁽²⁾⁽⁴⁾	Tension Parallel to Grain F _t (psi) ⁽²⁾⁽⁵⁾	Compression Parallel to Grain F _c (psi) ⁽²⁾	Compression Perpendicular to Grain F _{c⊥} (psi) ⁽¹⁾⁽⁶⁾	Equivalent Specific Gravity for Fastener Design (SG)
Versa-Lam [®] LVL Beams	2.1E 3100	2.1	2.0	1.1	3,100	285	2,150	3,000	750	0.5
Versa-Lam [®] LVL Studs	1.8E 2650	1.8	1.7	0.9	2,650	285	1,650	3,000	750	0.5
Versa-Lam [®] LVL Columns	1.8E 2650	1.8	1.7	0.9	2,650	285	1,650	3,000	750	0.5

NOTES

(1) Value cannot be adjusted for load duration.

(2) Value is based on 100% load duration and may be adjusted for other load durations.

(3) Fiber stress bending value shall be multiplied by the depth factor, (12/d)^{1/3} where d = member depth [in].

(4) Stress applied perpendicular to the glue lines.

(5) Tension value shall be multiplied by a length factor, (4/L)^{1/8} where L = member length [ft]. Use L = 4 for members less than four feet long.

(6) Stress applied parallel to the glue lines.

(7) True or shear-free modulus of elasticity does not account for shear deformation.

(8) E_{min} is the reference modulus of elasticity for beam and column stability calculations. It is calculated using E_{apparent} in accordance with Appendix D of the 2018 NDS. When calculating E_{min}, the coefficient of modulus of elasticity, COV_E, may be taken as 0.10, and the adjustment factor to convert E to a pure bending basis may be taken as 1.05.

► Design properties are limited to dry conditions of use where the maximum moisture content of the material will not exceed 16%.

Versa-Lam LVL 1.8E 2650 Columns

Allowable Axial Load (lb)

Column Length	3 1/2" x 3 1/2"			3 1/2" x 4 3/8"			3 1/2" x 5 1/4"			3 1/2" x 5 1/2"			3 1/2" x 7"		
	100%	115%	125%	100%	115%	125%	100%	115%	125%	100%	115%	125%	100%	115%	125%
4'	14,700	16,090	16,930	18,390	20,130	21,180	22,070	24,165	25,430	23,130	25,320	26,640	29,450	32,240	33,920
5'	12,270	13,150	13,660	15,350	16,440	17,090	18,425	19,740	20,515	19,300	20,680	21,490	24,580	26,330	27,365
6'	10,080	10,650	10,980	12,610	13,320	13,740	15,140	15,995	16,495	15,860	16,750	17,280	20,195	21,335	22,000
7'	8,310	8,705	8,930	10,400	10,890	11,170	12,480	13,075	13,415	13,080	13,700	14,050	16,650	17,435	17,890
8'	6,930	7,205	7,370	8,660	9,010	9,210	10,405	10,825	11,070	10,900	11,340	11,600	13,880	14,440	14,760
9'	5,840	6,050	6,160	7,300	7,560	7,710	8,770	9,080	9,260	9,190	9,510	9,700	11,700	12,115	12,350
10'	4,980	5,135	5,225	6,230	6,420	6,540	7,480	7,715	7,850	7,830	8,080	8,220	9,975	10,290	10,470
11'	4,290	4,410	4,480	5,360	5,520	5,600	6,445	6,625	6,730	6,750	6,940	7,050	8,595	8,835	8,975
12'	3,730	3,825	3,880	4,660	4,780	4,850	5,600	5,745	5,830	5,870	6,020	6,100	7,475	7,665	7,775
13'	3,270	3,350	3,390	4,090	4,190	4,240	4,915	5,030	5,095	5,150	5,270	5,340	6,555	6,710	6,795
14'	2,890	2,950	2,990	3,610	3,690	3,740	4,340	4,435	4,490	4,550	4,650	4,700	5,790	5,915	5,990
Column Length	3 1/2" x 7 1/4"			5 1/4" x 5 1/4"			5 1/4" x 5 1/2"			5 1/4" x 7"			5 1/4" x 7 1/4"		
	100%	115%	125%	100%	115%	125%	100%	115%	125%	100%	115%	125%	100%	115%	125%
4'	30,500	33,390	35,130												
5'	25,460	27,270	28,340												
6'	20,910	22,090	22,780	33,070	36,220	38,110	34,670	37,950	39,930						
7'	17,250	18,060	18,530	29,420	31,730	33,085	30,830	33,240	34,660						
8'	14,370	14,960	15,290	25,875	27,570	28,565	27,110	28,880	29,930	34,525	36,790	38,115	35,760	38,090	39,480
9'	12,120	12,540	12,790	22,690	23,970	24,715	23,770	25,110	25,900	30,275	31,985	32,980	31,360	33,130	34,160
10'	10,330	10,660	10,840	19,930	20,920	21,495	20,880	21,920	22,520	26,600	27,920	28,685	27,550	28,920	29,710
11'	8,900	9,150	9,300	17,585	18,375	18,820	18,420	19,250	19,720	23,465	24,510	25,125	24,310	25,400	26,010
12'	7,740	7,940	8,050	15,590	16,220	16,585	16,340	16,990	17,380	20,805	21,650	22,130	21,550	22,420	22,930
13'	6,790	6,950	7,040	13,895	14,410	14,700	14,560	15,100	15,400	18,545	19,225	19,620	19,210	19,920	20,320
14'	6,000	6,130	6,200	12,450	12,870	13,115	13,040	13,480	13,740	16,615	17,180	17,500	17,210	17,790	18,130
15'				11,210	11,560	11,760	11,740	12,110	12,320	14,960	15,425	15,695	15,490	15,980	16,260
16'				10,135	10,430	10,600	10,620	10,930	11,110	13,525	13,920	14,150	14,010	14,420	14,650
17'				9,205	9,455	9,600	9,650	9,910	10,060	12,285	12,620	12,810	12,730	13,070	13,270
18'				8,395	8,610	8,735	8,800	9,020	9,150	11,205	11,495	11,655	11,610	11,900	12,070
19'				7,685	7,870	7,975	8,050	8,250	8,360	10,260	10,505	10,645	10,620	10,880	11,030
20'				7,060	7,220	7,310	7,400	7,560	7,660	9,420	9,635	9,760	9,760	9,980	10,110
21'				6,505	6,645	6,725	6,820	6,960	7,050	8,680	8,870	8,980	8,990	9,190	9,300

NOTES

- ▶ Table assumes that the column is braced at column ends only. Effective column length is equal to actual column length.
- ▶ Allowable loads are based upon one-piece (solid) column members used in dry service conditions. BC Calc® software may be used for multi-piece column design.
- ▶ Allowable loads are based on an eccentricity value equal to 0.167 multiplied by either the column thickness or width (worst case).
- ▶ Allowable loads are based on axially loaded columns using the design provisions of the 2018 *National Design Specification (NDS) for Wood Construction*. Table capacity values based upon a buckling length coefficient, (K_e) equal to 1.0 (rotation free, translation fixed at each column end per NDS Appendix G). A K_e coefficient of 1.0 conservatively models typical wood column applications. For other end fixity conditions, contact Boise Cascade EWP Engineering. For side or other combined bending and axial loads, see provisions in 2018 NDS.
- ▶ Load values are not shown for short lengths due to loads exceeding common connector capacities. Load values are not shown for longer lengths if the controlling slenderness ratio exceeds 50 (per NDS).
- ▶ Lateral loads (wind loading) are not considered in this table. BC Calc® software may be used for out-of-plane lateral load column application design.

Versa-Stud LVL 1.8E 2650

Reference Design Values

Product	Bending F_b (psi)	Compression Parallel to Grain $F_{c }$ (psi)	Compression Perp to Grain $F_{c\perp}$ (psi)	Modulus of Elasticity – Apparent E (psi)	Horizontal Shear F_v (psi)
Versa-Stud® 1.8E 2650 1 1/2" x 5 1/2"	2,890	3,000	610	1,700,000	285
Spruce Pine Fir (North) # 1 / 2 Grade 2 x 6	1,138	1,150	425	1,400,000	135
Hem-Fir # 2 Grade 2 x 6	1,105	1,300	405	1,300,000	150
Western Woods # 2 Grade 2 x 6	878	900	335	1,000,000	135

NOTES

- ▶ Design values are for loads applied to the narrow face of the studs.
- ▶ Dimension lumber values per *NDS Supplement, Design Values for Wood Construction*, 2018 Edition.
- ▶ Repetitive member factors have not been applied to the bending values. Depth (size) factors per ICC-ES®/APA® ESR-1040 and 2018 NDS have been applied to the corresponding bending values.

For additional design information, please see the *Versa-Stud Eastern Tall Wall Guide*.

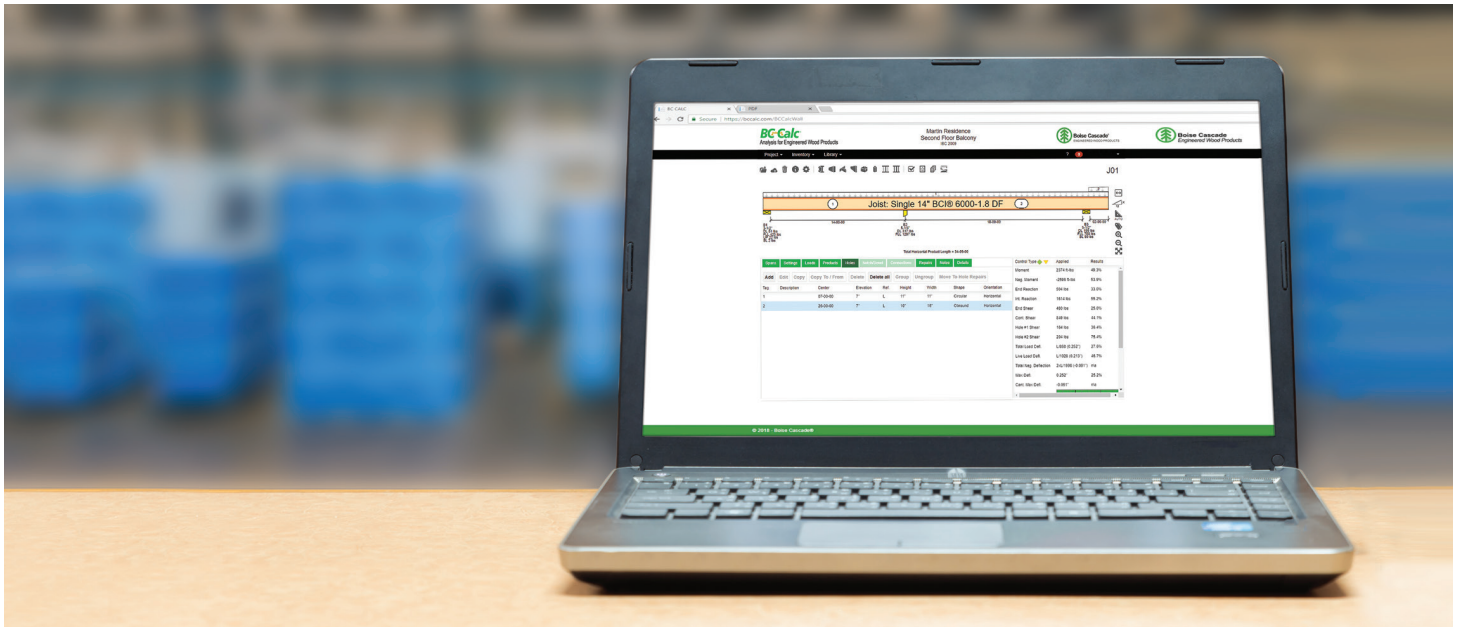

INTEGRATED SOFTWARE FOR EASY SPECIFICATION

All Boise Cascade's engineered wood products are incorporated into Boise Cascade's software suite. BC Framer®, BC Connect®, BC Calc®, and SawTek® all work together, seamlessly integrating design and processing technology into one automated system.

SOFTWARE BENEFITS

- ▶ Design member by member in BC Calc, or create a complete 3D model in BC Framer
- ▶ Dealers can manage projects and material lists and optimize manual or automated saw cut patterns in BC Connect
- ▶ SawTek's processing software cuts, drills, and labels job packs according to your specifications

With Boise Cascade's software suite, there's no need to worry about missing pieces or manual entry errors. The software applications share data digitally, ensuring nothing gets lost or mistyped.

Boise Cascade's software suite is available at www.bc.com/ewp/software/

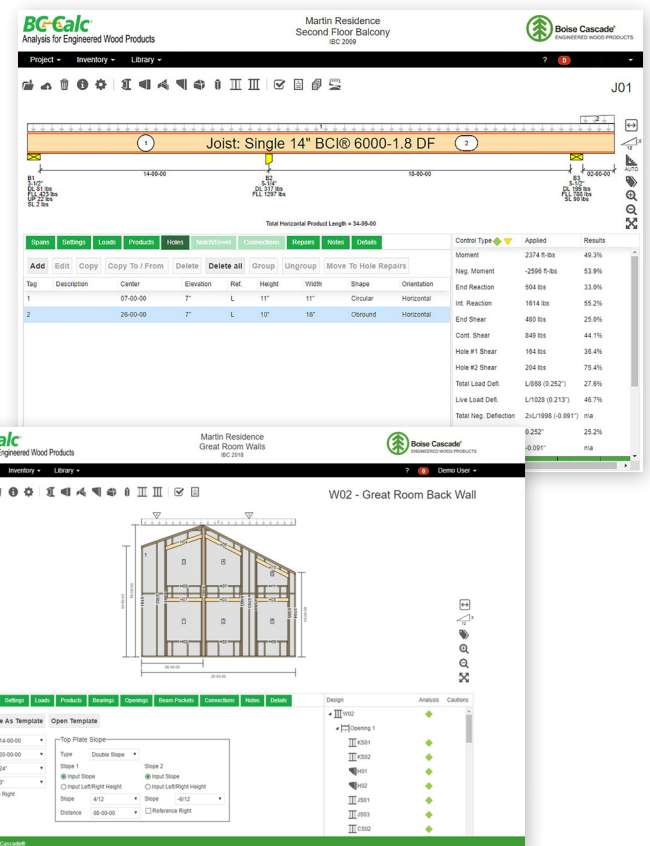

Framing Connectors: Simpson Strong-Tie

Single Joist – Top Flange



Single Joist – Face Mount

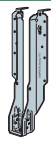

Face Mount Skewed 45° Joist Hanger

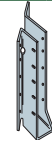

Joist Depth	BCI® Series	Hanger	Capacity (lbs)	Nailing		Joist Depth	BCI® Series	Hanger	Capacity (lbs)	Nailing		Joist Depth	BCI® Series	Hanger	Capacity (lbs)	Nailing	
				Header	Joist					Header	Joist					Header	Joist
9 1/2"	4500s	ITS1.81/9.5	993	6-10d	–	9 1/2"	4500s	IUS1.81/9.5	950	8-10d	–	9 1/2"	4500s	SUR/L1.81/9	1,081	12-16d	2-10dx1 1/2"
	5000s	ITS2.06/9.5	993	6-10d	–		5000s	IUS2.06/9.5	950	8-10d	–		5000s	SUR/L2.06/9	1,097	14-16d	2-10dx1 1/2"
	6000s	ITS2.37/9.5	1,225	6-10d	–		6000s	IUS2.37/9.5	950	8-10d	–		6000s	SUR/L2.37/9	1,343	14-16d	2-10dx1 1/2"
	6500s	ITS2.56/9.5	1,225	6-10d	–		6500s	IUS2.56/9.5	950	8-10d	–		6500s	SUR/L2.56/9	1,343	14-16d	2-10dx1 1/2"
11 7/8"	4500s	ITS1.81/11.88	1,068	6-10d	–	11 7/8"	4500s	IUS1.81/11.88	1,185	10-10d	–	11 7/8"	4500s	SUR/L1.81/11	1,306	16-16d	2-10dx1 1/2"
	5000s	ITS2.06/11.88	1,068	6-10d	–		5000s	IUS2.06/11.88	1,185	10-10d	–		5000s	SUR/L2.06/11	1,350	16-16d	2-10dx1 1/2"
	6000s	ITS2.37/11.88	1,237	6-10d	–		6000s	IUS2.37/11.88	1,185	10-10d	–		6000s	SUR/L2.37/11	1,385	16-16d	2-10dx1 1/2"
	6500s	ITS2.56/11.88	1,237	6-10d	–		6500s	IUS2.56/11.88	1,185	10-10d	–		6500s	SUR/L2.56/11	1,385	16-16d	2-10dx1 1/2"
14"	60s	ITS2.37/11.88	1,237	6-10d	–	14"	60s	IUS2.37/11.88	1,185	10-10d	–	14"	60s	SUR/L2.37/11	1,385	16-16d	2-10dx1 1/2"
	90s	ITS3.56/11.88	1,518	6-10d	–		90s	IUS3.56/11.88	1,420	12-10d	–		90s	SUR/L410	1,906	14-16d	2-10dx1 1/2"
	4500s	ITS1.81/14	1,075	6-10d	–		4500s	IUS1.81/14	1,420	12-10d	–		4500s	SUR/L1.81/14	1,675	20-16d	2-10dx1 1/2"
	5000s	ITS2.06/14	1,081	6-10d	–		5000s	IUS2.06/14	1,420	12-10d	–		5000s	SUR/L2.06/14	1,693	18-16d	2-10dx1 1/2"
16"	6000s	ITS2.37/14	1,262	6-10d	–	16"	6000s	IUS2.37/14	1,420	12-10d	–	16"	6000s	SUR/L2.37/14	1,693	18-16d	2-10dx1 1/2"
	6500s	ITS2.56/14	1,262	6-10d	–		6500s	IUS2.56/14	1,420	12-10d	–		6500s	SUR/L2.56/14	1,693	18-16d	2-10dx1 1/2"
	60s	ITS2.37/14	1,262	6-10d	–		60s	IUS2.37/14	1,420	12-10d	–		60s	SUR/L2.37/14	1,693	18-16d	2-10dx1 1/2"
	90s	ITS3.56/14	1,520	6-10d	–		90s	IUS3.56/14	1,420	12-10d	–		90s	SUR/L414	2,050	18-16d	2-10dx1 1/2"
16"	4500s	ITS1.81/16	1,081	6-10d	–	16"	4500s	IUS1.81/16	1,660	14-10d	–	16"	4500s	SUR/L1.81/14	1,887	20-16d	2-10dx1 1/2"
	5000s	ITS2.06/16	1,087	6-10d	–		5000s	IUS2.06/16	1,660	14-10d	–		5000s	SUR/L2.06/11	1,920	18-16d	2-10dx1 1/2"
	6000s	ITS2.37/16	1,268	6-10d	–		6000s	IUS2.37/16	1,660	14-10d	–		6000s	SUR/L2.37/14	1,920	18-16d	2-10dx1 1/2"
	6500s	ITS2.56/16	1,268	6-10d	–		6500s	IUS2.56/16	1,660	14-10d	–		6500s	SURI/L2.56/14	1,920	18-16d	2-10dx1 1/2"
16"	60s	ITS2.37/16	1,268	6-10d	–	16"	60s	IUS2.37/16	1,660	14-10d	–	16"	60s	SUR/L2.37/14	1,920	18-16d	2-10dx1 1/2"
	90s	ITS3.56/16	1,520	6-10d	–		90s	IUS3.56/16	1,425	14-10d	–		90s	SUR/L414	2,250	18-16d	2-10dx1 1/2"

Double Joist – Top Flange

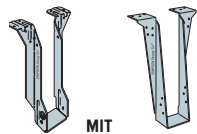

Double Joist – Face Mount

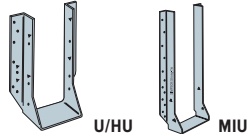

Field Slope and Skew Joist Hanger



Joist Depth	BCI® Series	Hanger	Capacity (lbs)	Nailing		Joist Depth	BCI® Series	Hanger	Capacity (lbs)	Nailing		Joist Depth	BCI® Series	Hanger	Capacity (lbs)	Nailing	
				Header	Joist					Header	Joist					Header	Joist
9 1/2"	4500s	MIT49.5	2,305	8-16d	2-10dx1 1/2"	9 1/2"	4500s	MIU3.56/9	2,305	16-16d	2-10dx1 1/2"	9 1/2"	4500s	LSSR1.81Z	1,205	13-0.148 x 2 1/2"	9-0.148 x 1 1/2"
	5000s	MIT4.12/9.5	2,305	8-16d	2-10dx1 1/2"		5000s	MIU4.12/9	2,305	16-16d	2-10dx1 1/2"		5000s	LSSR2.37Z	1,205	13-0.148 x 2 1/2"	9-0.148 x 1 1/2"
	6000s	MIT359.5-2	2,305	8-16d	2-10dx1 1/2"		6000s	MIU4.75/9	2,305	16-16d	2-10dx1 1/2"		6000s	LSSR2.56Z	1,205	13-0.148 x 2 1/2"	9-0.148 x 1 1/2"
	6500s	MIT39.5-2	2,305	8-16d	2-10dx1 1/2"		6500s	MIU5.12/9	2,305	16-16d	2-10dx1 1/2"		6500s	LSSR2.56Z	1,205	13-0.148 x 2 1/2"	9-0.148 x 1 1/2"
11 7/8"	4500s	MIT411.88	2,305	8-16d	2-10dx1 1/2"	11 7/8"	4500s	MIU3.56/11	2,880	20-16d	2-10dx1 1/2"	11 7/8"	4500s	LSSR1.81Z	1,205	13-0.148 x 2 1/2"	9-0.148 x 1 1/2"
	5000s	MIT4.12/11.88	2,305	8-16d	2-10dx1 1/2"		5000s	MIU4.12/11	2,880	20-16d	2-10dx1 1/2"		5000s	LSSR2.37Z	1,205	13-0.148 x 2 1/2"	9-0.148 x 1 1/2"
	6000s	MIT3511.88-2	2,305	8-16d	2-10dx1 1/2"		6000s	MIU4.75/11	2,880	20-16d	2-10dx1 1/2"		6000s	LSSR2.37Z	1,205	13-0.148 x 2 1/2"	9-0.148 x 1 1/2"
	6500s	MIT311.88-2	2,305	8-16d	2-10dx1 1/2"		6500s	MIU5.12/11	2,880	20-16d	2-10dx1 1/2"		6500s	LSSR2.56Z	1,205	13-0.148 x 2 1/2"	9-0.148 x 1 1/2"
14"	60s	MIT3511.88-2	2,305	8-16d	2-10dx1 1/2"	14"	60s	MIU4.75/11	2,600	20-16d	2-10dx1 1/2"	14"	60s	LSSR2.56Z	1,205	13-0.148 x 2 1/2"	9-0.148 x 1 1/2"
	90s	B7.12/11.88	3,800	14-16d	2-10dx1 1/2"		90s	HU412-2	3,275	22-16d	2-10dx1 1/2"		90s	LSSR2.37Z	1,205	13-0.148 x 2 1/2"	9-0.148 x 1 1/2"
	4500s	MIT414	2,305	8-16d	2-10dx1 1/2"		4500s	MIU3.56/14	3,170	22-16d	2-10dx1 1/2"		4500s	LSSR410Z	1,810	20-0.162 x 2 1/2"	13-0.162 x 2 1/2"
	5000s	MIT4.12/14	2,305	8-16d	2-10dx1 1/2"		5000s	MIU4.12/14	3,170	22-16d	2-10dx1 1/2"		5000s	LSSR1.81Z	1,205	13-0.148 x 2 1/2"	9-0.148 x 1 1/2"
16"	6000s	MIT3514-2	2,305	8-16d	2-10dx1 1/2"	16"	6000s	MIU4.75/14	3,170	22-16d	2-10dx1 1/2"	16"	6000s	LSSR2.37Z	1,205	13-0.148 x 2 1/2"	9-0.148 x 1 1/2"
	6500s	MIT314-2	2,305	8-16d	2-10dx1 1/2"		6500s	MIU5.12/14	3,170	22-16d	2-10dx1 1/2"		6500s	LSSR2.37Z	1,205	13-0.148 x 2 1/2"	9-0.148 x 1 1/2"
	60s	MIT3514-2	2,305	8-16d	2-10dx1 1/2"		60s	MIU4.75/14	2,700	22-16d	2-10dx1 1/2"		60s	LSSR2.56Z	1,205	13-0.148 x 2 1/2"	9-0.148 x 1 1/2"
	90s	B7.12/14	3,800	14-16d	2-10dx1 1/2"		90s	HU414-2	3,870	26-16d	2-10dx1 1/2"		90s	LSSR2.37Z	1,205	13-0.148 x 2 1/2"	9-0.148 x 1 1/2"
16"	4500s	MIT416	2,305	8-16d	2-10dx1 1/2"	16"	4500s	MIU3.56/16	3,455	24-16d	2-10dx1 1/2"	16"	4500s	LSSR2.37Z	1,205	13-0.148 x 2 1/2"	9-0.148 x 1 1/2"
	5000s	LBV4.12/16	2,460	10-16d	2-10dx1 1/2"		5000s	MIU4.12/16	3,455	24-16d	2-10dx1 1/2"		5000s	LSSR2.56Z	1,205	13-0.148 x 2 1/2"	9-0.148 x 1 1/2"
	6000s	MIT4.75/16	2,305	8-16d	2-10dx1 1/2"		6000s	MIU4.75/16	3,455	24-16d	2-10dx1 1/2"		6000s	LSSR2.37Z	1,205	13-0.148 x 2 1/2"	9-0.148 x 1 1/2"
	6500s	MIT5.12/16	2,305	8-16d	2-10dx1 1/2"		6500s	MIU5.12/16	3,455	24-16d	2-10dx1 1/2"		6500s	LSSR2.37Z	1,205	13-0.148 x 2 1/2"	9-0.148 x 1 1/2"
16"	60s	MIT4.75/16	2,305	8-16d	2-10dx1 1/2"	16"	60s	MIU4.75/16	2,725	24-16d	2-10dx1 1/2"	16"	60s	LSSR2.37Z	1,205	13-0.148 x 2 1/2"	9-0.148 x 1 1/2"
	90s	B7.12/16	3,800	14-16d	2-10dx1 1/2"		90s	HU414-2	3,780	26-16d	2-10dx1 1/2"		90s	LSSR410Z	1,810	20-0.162 x 2 1/2"	13-0.162 x 2 1/2"

Adjustable Height Joist Hanger

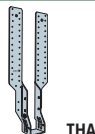

Variable Pitch Joist Connector

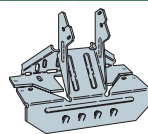

Drive 10d x 1 1/2" nails through bend tabs at a 45° angle.

Joist Depth	BCI® Series	Hanger	Capacity (lbs)	Nailing		Joist Depth	BCI® Series	Hanger	Capacity (lbs)	Fastener	
				Header	Joist					Top Plate	Rafter
9 1/2"	4500s	THAI1.81/22	1,181	6-10d	2-10dx1 1/2"	9 1/2"	4500s	LSSU125	995	9-10d	7-10dx1 1/2"
	5000s	THAI2.06/22	1,181	6-10d	2-10dx1 1/2"		5000s	LSSU2.06	995	9-10d	7-10dx1 1/2"
	6000s	THAI3522	1,393	6-10d	2-10dx1 1/2"		6000s	LSSU135	995	9-10d	7-10dx1 1/2"
	6500s	THAI322	1,393	6-10d	2-10dx1 1/2"		6500s	LSSUH310	1,425	14-10d	7-10dx1 1/2"
11 7/8"	4500s	THAI1.81/22	1,443	6-10d	2-10dx1 1/2"	11 7/8"	4500s	LSSU125	995	9-10d	7-10dx1 1/2"
	5000s	THAI2.06/22	1,443	6-10d	2-10dx1 1/2"		5000s	LSSU2.06	995	9-10d	7-10dx1 1/2"
	6000s	THAI3522	1,443	6-10d	2-10dx1 1/2"		6000s	LSSU135	995	9-10d	7-10dx1 1/2"
	6500s	THAI322	1,443	6-10d	2-10dx1 1/2"		6500s	LSSUH310	1,475	14-10d	7-10dx1 1/2"
14"	60s	THAI3522	1,443	6-10d	2-10dx1 1/2"	14"	60s	LSSU135	995	9-10d	7-10dx1 1/2"
	90s	THAI422	1,715	6-10d	2-10dx1 1/2"		90s	LSSU410	1,625	14-10d	12-10dx1 1/2"
	4500s	THAI1.81/22	1,600	6-10d	2-10dx1 1/2"</						

Framing Connectors: MiTek Structural Connectors

Single Joist – Top Mount

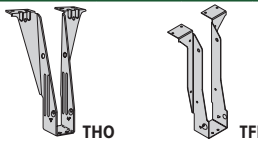

Joist Depth	BCI® Series	Hanger	Capacity [lbs]	Nailing	
				Header	Joist
9 1/2"	4500s	THO17950	993	(6) 10d	(2) 10d x 1 1/2"
	5000s	TFL2095	993	(6) 10d	(2) 10d x 1 1/2"
	6000s	TFL2395	1,225	(6) 10d	(2) 10d x 1 1/2"
11 7/8"	6500s	THO26950	1,262	(10) 10d	(2) 10d x 1 1/2"
	4500s	THO17118	1,068	(6) 10d	(2) 10d x 1 1/2"
	5000s	TFL20118	1,068	(6) 10d	(2) 10d x 1 1/2"
	6000s	TFL23118	1,237	(6) 10d	(2) 10d x 1 1/2"
	6500s	THO26118	1,284	(10) 10d	(2) 10d x 1 1/2"
	60s	TFL23118	1,237	(6) 10d	(2) 10d x 1 1/2"
14"	90s	THO35118	1,589	(10) 10d	(2) 10d x 1 1/2"
	4500s	TFL1714	1,075	(6) 10d	(2) 10d x 1 1/2"
	5000s	TFL2014	1,081	(6) 10d	(2) 10d x 1 1/2"
	6000s	TFL2314	1,262	(6) 10d	(2) 10d x 1 1/2"
	6500s	THO26140	1,328	(12) 10d	(2) 10d x 1 1/2"
	60s	TFL2314	1,262	(6) 10d	(2) 10d x 1 1/2"
16"	90s	THO35140	1,625	(12) 10d	(2) 10d x 1 1/2"
	4500s	TFL1716	1,081	(6) 10d	(2) 10d x 1 1/2"
	5000s	TFL2016	1,087	(6) 10d	(2) 10d x 1 1/2"
	6000s	TFL2316	1,268	(6) 10d	(2) 10d x 1 1/2"
	6500s	THO26160	1,339	(12) 10d	(2) 10d x 1 1/2"
	60s	TFL2316	1,268	(6) 10d	(2) 10d x 1 1/2"
90s	THO35160	1,660	(12) 10d	(2) 10d x 1 1/2"	

Single Joist – Face Mount

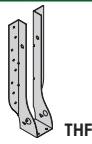

Joist Depth	BCI® Series	Hanger	Capacity [lbs]	Nailing	
				Header	Joist
9 1/2"	4500s	IHFL17925	960	(8) 10d	–
	5000s	IHFL20925	960	(8) 10d	–
	6000s	IHFL23925	960	(8) 10d	–
11 7/8"	6500s	THFI2595	1,250	(8) 10d	–
	4500s	IHFL17112	1,187	(10) 10d	–
	5000s	IHFL20112	1,187	(10) 10d	–
	6000s	IHFL23112	1,200	(10) 10d	–
	6500s	THFI25118	1,250	(10) 10d	–
	60s	IHFL23112	1,200	(10) 10d	–
14"	90s	IHFL35112	1,200	(10) 10d	–
	4500s	IHFL1714	1,200	(12) 10d	–
	5000s	IHFL2014	1,212	(12) 10d	–
	6000s	IHFL2314	1,350	(12) 10d	–
	6500s	THF2514	1,350	(14) 10d	–
	60s	IHFL2314	1,350	(12) 10d	–
16"	90s	IHFL3514	1,440	(12) 10d	–
	4500s	IHFL1716	1,212	(14) 10d	–
	5000s	IHFL2016	1,225	(14) 10d	–
	6000s	IHFL2316	1,362	(14) 10d	–
	6500s	IHF2616	1,362	(14) 10d	(2) 10d x 1 1/2"
	60s	IHFL2316	1,362	(14) 10d	–
90s	IHFL3516	1,680	(14) 10d	–	

Single Joist – Face Mount Skewed 45°

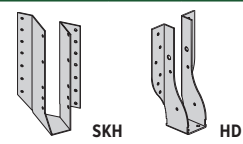

Joist Depth	BCI®	Hanger	Capacity [lbs]	Nailing	
				Header	Joist
9 1/2"	4500s	SKH1720L/R	1,153	(14) 10d	(10) 10d x 1 1/2"
	5000s	SKH2020L/R	1,153	(14) 10d	(10) 10d x 1 1/2"
	6000s	SKH2320L/R	1,384	(14) 10d	(10) 10d x 1 1/2"
11 7/8"	6500s	SKH2520L/R	1,384	(14) 10d	(10) 10d x 1 1/2"
	4500s	SKH1720L/R	1,434	(14) 10d	(10) 10d x 1 1/2"
	5000s	SKH2020L/R	1,434	(14) 10d	(10) 10d x 1 1/2"
	6000s	SKH2320L/R	1,434	(14) 10d	(10) 10d x 1 1/2"
	6500s	SKH2520L/R	1,434	(14) 10d	(10) 10d x 1 1/2"
	60s	SKH2320L/R	1,434	(14) 10d	(10) 10d x 1 1/2"
14"	90s	SKH410L/R	1,900	(16) 10d	(10) 16d
	4500s	SKH1720L/R	1,562	(14) 10d	(10) 10d x 1 1/2"
	5000s	SKH2020L/R	1,562	(14) 10d	(10) 10d x 1 1/2"
	6000s	SKH2320L/R	1,562	(14) 10d	(10) 10d x 1 1/2"
	6500s	SKH2520L/R	1,562	(14) 10d	(10) 10d x 1 1/2"
	60s	SKH2320L/R	1,562	(14) 10d	(10) 10d x 1 1/2"
16"	90s	SKH410L/R	2,050	(16) 10d	(10) 16d
	4500s	SKH1720L/R	1,635	(16) 10d	(10) 10d x 1 1/2"
	5000s	SKH2024L/R	1,643	(16) 10d	(10) 10d x 1 1/2"
	6000s	SKH2324L/R	1,690	(16) 10d	(10) 10d x 1 1/2"
	6500s	SKH2524L/R	1,690	(16) 10d	(10) 10d x 1 1/2"
	60s	SKH2324L/R	1,690	(16) 10d	(10) 10d x 1 1/2"
90s	SKH414L/R	2,250	(22) 16d	(10) 16d	

Double Joist – Top Mount

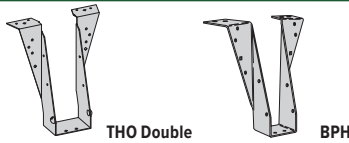

Joist Depth	BCI® Series	Hanger	Capacity [lbs]	Nailing	
				Header	Joist
9 1/2"	4500s	THO35950	2,053	(10) 10d	(2) 10d x 1 1/2"
	5000s	THO20950-2	2,475	(10) 16d	(6) 10d
	6000s	THO23950-2	2,825	(10) 16d	(6) 10d
	6500s	THO25950-2	2,825	(10) 16d	(6) 10d
11 7/8"	4500s	THO35118	2,315	(10) 10d	(2) 10d x 1 1/2"
	5000s	THO20118-2	2,920	(10) 16d	(6) 10d
	6000s	THO23118-2	2,925	(10) 16d	(6) 10d
	6500s	THO25118-2	2,925	(10) 16d	(6) 10d
	60s	THO23118-2	3,212	(10) 16d	(6) 10d
	90s	BPH71118	3,075	(10) 16d	(6) 10d
14"	4500s	THO35140	2,315	(12) 10d	(2) 10d x 1 1/2"
	5000s	THO20140-2	3,350	(10) 16d	(6) 10d
	6000s	THO23140-2	3,350	(12) 16d	(6) 10d
	6500s	THO25140-2	3,350	(12) 16d	(6) 10d
	60s	THO23140-2	3,587	(12) 16d	(6) 10d
	90s	BPH7114	3,075	(10) 16d	(6) 10d
16"	4500s	THO35160	2,359	(12) 10d	(2) 10d x 1 1/2"
	5000s	THO20160-2	3,377	(10) 16d	(6) 10d
	6000s	THO23160-2	3,137	(12) 16d	(6) 10d
	6500s	THO25160-2	3,137	(12) 16d	(6) 10d
	60s	THO23160-2	4,050	(12) 16d	(6) 10d
	90s	BPH7116	3,075	(10) 16d	(6) 10d

Double Joist – Face Mount

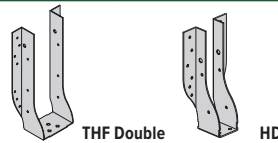

Joist Depth	BCI® Series	Hanger	Capacity [lbs]	Nailing	
				Header	Joist
9 1/2"	4500s	IHFL35925	1,200	(10) 10d	–
	5000s	IHF20925-2	1,250	(10) 10d	(2) 10d x 1 1/2"
	6000s	IHF23925-2	1,250	(10) 10d	(2) 10d x 1 1/2"
11 7/8"	6500s	THF25925-2	1,250	(10) 10d	(2) 10d x 1 1/2"
	4500s	IHFL35112	1,200	(10) 10d	–
	5000s	IHF20112-2	1,250	(10) 10d	(2) 10d x 1 1/2"
	6000s	THF23118-2	1,890	(16) 10d	(6) 10d
	6500s	THF25112-2	1,250	(10) 10d	(2) 10d x 1 1/2"
	60s	THF23118-2	1,890	(16) 10d	(6) 10d
14"	90s	HD7120	2,465	(16) 16d	(6) 16d
	4500s	IHFL3514	1,440	(12) 10d	–
	5000s	IHF2014-2	1,500	(12) 10d	(2) 10d x 1 1/2"
	6000s	THF23140-2	2,660	(20) 10d	(6) 10d
	6500s	THF25140-2	2,660	(20) 10d	(6) 10d
	60s	THF23140-2	2,660	(20) 10d	(6) 10d
16"	90s	HD7140	3,080	(20) 16d	(8) 16d
	4500s	IHFL3516	1,680	(12) 10d	–
	5000s	IHF2014-2	1,500	(12) 10d	(2) 10d x 1 1/2"
	6000s	THF23160-2	3,175	(24) 10d	(6) 10d
	6500s	THF25160-2	3,175	(24) 10d	(6) 10d
	60s	THF23160-2	3,190	(24) 10d	(6) 10d
90s	HD7160	3,695	(24) 16d	(8) 16d	

Single Joist – Variable Pitch Connector

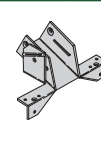

Joist Depth	BCI®	Hanger	Capacity [lbs]	Nailing	
				Header	Joist
9 1/2"	4500s	TMP175	1,125	(6) 10d	(4) 10d x 1 1/2"
	5000s	TMP21	1,125	(6) 10d	(4) 10d x 1 1/2"
	6000s	TMP23	1,375	(6) 10d	(4) 10d x 1 1/2"
11 7/8"	6500s	TMP25	1,375	(6) 10d	(4) 10d x 1 1/2"
	4500s	TMP175	1,425	(6) 10d	(4) 10d x 1 1/2"
	5000s	TMP21	1,425	(6) 10d	(4) 10d x 1 1/2"
	6000s	TMP23	1,425	(6) 10d	(4) 10d x 1 1/2"
	6500s	TMP25	1,425	(6) 10d	(4) 10d x 1 1/2"
	60s	TMP23	1,425	(6) 10d	(4) 10d x 1 1/2"
14"	90s	TMP4	1,705	(6) 10d	(4) 10d x 1 1/2"
	4500s	TMP175	1,450	(6) 10d	(4) 10d x 1 1/2"
	5000s	TMP21	1,475	(6) 10d	(4) 10d x 1 1/2"
	6000s	TMP23	1,525	(6) 10d	(4) 10d x 1 1/2"
	6500s	TMP25	1,525	(6) 10d	(4) 10d x 1 1/2"
	60s	TMP23	1,525	(6) 10d	(4) 10d x 1 1/2"
16"	90s	TMP4	1,705	(6) 10d	(4) 10d x 1 1/2"
	4500s	TMP175	1,450	(6) 10d	(4) 10d x 1 1/2"
	5000s	TMP21	1,500	(6) 10d	(4) 10d x 1 1/2"
	6000s	TMP23	1,550	(6) 10d	(4) 10d x 1 1/2"
	6500s	TMP25	1,550	(6) 10d	(4) 10d x 1 1/2"
	60s	TMP23	1,550	(6) 10d	(4) 10d x 1 1/2"
90s	TMP4	1,705	(6) 10d	(4) 10d x 1 1/2"	

Single Joist – Adjustable Height



Joist Depth	BCI®	Hanger	Capacity [lbs]	Nailing	
				Header	Joist
9 1/2"	4500s	MSH1722	1,143	(6) 10d	(4) 10d x 1 1/2"
	5000s	MSH2022	1,143	(6) 10d	(4) 10d
	6000s	MSH2322	1,381	(6) 10d	(4) 10d x 1 1/2"
	6500s	MSH322	1,381	(6) 10d	(4) 10d x 1 1/2"
11 7/8"	4500s	MSH1722	1,431	(6) 10d	(4) 10d x 1 1/2"
	5000s	MSH2022	1,431	(6) 10d	(4) 10d
	6000s	MSH2322	1,431	(6) 10d	(4) 10d x 1 1/2"
	6500s	MSH322	1,431	(6) 10d	(4) 10d x 1 1/2"
	60s	MSH2322	1,431	(6) 10d	(4) 10d x 1 1/2"
	90s	MSH422	1,862	(6) 10d	(6) 10d
14"	4500s	MSH1722	1,550	(6) 10d	(4) 10d x 1 1/2"
	5000s	MSH2022	1,550	(6) 10d	(4) 10d
	6000s	MSH2322	1,550	(6) 10d	(4) 10d x 1 1/2"
	6500s	MSH322	1,550	(6) 10d	(4) 10d x 1 1/2"
	60s	MSH2322	1,550	(6) 10d	(4) 10d x 1 1/2"
	90s	MSH422	1,975	(6) 10d	(6) 10d
16"	4500s	MSH1722	1,668	(6) 10d	(4) 10d x 1 1/

Boise Cascade is one of the largest producers of engineered wood products in North America. With coast-to-coast distribution, we strive to meet our customer's needs through regional product offerings, on-time delivery, and continued technical support long after the sale. We know our success depends upon yours. And that's why we offer a full line of innovative engineered wood products that give you the strength, stability, and consistent performance you need for each project—and every challenge.

BCI® and AJS® Joists

Strong and secure, yet lightweight and easy to install, BCI and AJS joists give you flat, stable, quiet floors and strong roofs with crisp ridge lines. Every BCI and AJS joist is manufactured and tested to meet exacting requirements and specifications — delivering dependable results and fewer callbacks.

Versa-Lam® LVL Beams and Headers

Get industry-leading strength and value without sacrifice. With long spans and high dimensional stability, Versa-Lam LVL beams and headers help create sprawling living spaces in both single and multifamily builds without twisting, bowing or warping.

Versa-Stud® Wall Framing

Facing a tall wall challenge? Versa-Stud wall framing has the length, strength and wind resistance you need. It's ideal for applications where a straight, stiff wall is critical.

Boise Cascade® Rimboard

Offered in long lengths and depths that match BCI and AJS joists, Boise Cascade Rimboard installs quickly, is easy to handle, and saves you time.

BC Calc® Sizing Software

BC Calc puts the full range of Boise Cascade EWP at your fingertips. Quickly size single members, review results, and verify requirements all with just a few clicks.

When you put it all together, Boise Cascade's Engineered Wood Products (EWP) and software tools make building strong homes easier, faster, and more profitable for home builders.

Limited Lifetime Warranty
All Boise Cascade BCI® joist, Versa-Lam® LVL, and AJS® joist products are covered by a limited lifetime warranty for the expected life of the structure. View the complete warranty on our website.

bc.com/terms-conditions/sales-terms-and-conditions

NEED MORE INFORMATION?

Visit bc.com/ewp
or call 1-800-232-0788



Boise Cascade®
ENGINEERED WOOD PRODUCTS

Information provided herein was current at the time of printing but may be superseded by an updated version. Visit bc.com/ewp to confirm that this is the most current guide.

Boise Cascade, TREE-IN-A-CIRCLE design mark, AJS, BC Calc, BC Connect, BC Framer, BCI, Versa-Lam, and Versa-Stud are registered trademarks of Boise Cascade Company or its affiliates. © 2026 Boise Cascade Company. All rights reserved.