



# Traditional

## Roof Garden Roofing System

### TABLE OF CONTENTS

July 2025

		Page
<b>PART I - General</b>		
1.01	Description.....	3
1.02	General Design Considerations.....	4
1.03	Quality Assurance.....	5
1.04	Submittals.....	5
1.05	Warranty.....	6
	<b>TABLE I – Roof Garden System Warranty Options .....</b>	<b>7</b>
1.06	Job Conditions.....	8
1.07	Product Delivery, Storage and Handling.....	8
<b>PART II – Products</b>		
2.01	General.....	9
2.02	Membrane/Related Products.....	9
2.03	Carlisle Roof Garden Components.....	10
2.04	Other Non-Carlisle Products.....	12
<b>PART III – Execution</b>		
3.01	General.....	12
3.02	Roof Deck Criteria.....	12
3.03	Substrate Preparation.....	13
3.04	Waterproofing Installation.....	13
3.05	Roof Garden Installation.....	14
	A. Prior to Installation of Roof Garden Components.....	14
	B. Shallow (Extensive) Roof Garden Installation.....	15
	C. Medium (Semi-Intensive) Roof Garden Installation.....	17
	D. Deep (Intensive) Roof Garden Installation.....	19
3.06	Night Seal.....	20
3.07	After Installation of Roof Garden Components.....	20
<b>ATTACHMENTS</b>		
	“Attachment I” Roof Garden Care & Maintenance Requirements.....	21
	Installation Details.....	29





## Traditional

### Roof Garden Roofing System

July 2025

*The information contained in this generic specification represents a part of Carlisle's requirements for obtaining a roofing systems warranty. Construction materials and practices, building siting and operation, climatic conditions, and other site-specific factors will have an impact on the performance of the roofing system. Carlisle recommends that the building owner retain a design professional to determine appropriate design measures to be taken in order to address these factors.*

*This section is to serve as criteria for Specifiers and Authorized Applicators regarding the design and installation of Carlisle's Roof Garden Roofing System. Additional information essential for the design and installation of the roof system mentioned herein are also included in the Design Reference Section and also listed in the form of a Specification Supplement at the end of the Technical Manual. Specifiers and Authorized Applicators are advised to reference all applicable sections.*

*A Warranty Table has been included in Paragraph 1.05 citing various requirements by which specific warranty coverage can be obtained.*

#### **PART I – GENERAL**

##### **1.01 Description**

- A. The **Carlisle Roof Garden System** incorporates an adhered membrane waterproofing system with one of three types of Roof Garden Assemblies installed above the membrane.

The membranes include EPDM, TPO, PVC, KEE HP, FleeceBACK (EPDM, TPO, PVC or KEE HP) or AFX (EPDM or TPO) products and are installed over a structural concrete deck (FleeceBACK or AFX Only) or tapered insulation and cover board.

The Roof Garden Assemblies utilize various components including Root Barrier, Polystyrene Insulation, MiraDRAIN® G4 Drainage Composite, Carlisle Growth Media and Carlisle Vegetation. These components are installed above the membrane dependent on desired planting schedule, allowable loads and the climatic region of the project.

As an alternative to the traditional, planted-in-place Roof Garden System, Carlisle offers the modular Green Grid tray, and Hydropack modules, which incorporate a protection fabric and pre-planted modules over the adhered waterproofing system. Refer to Modular Tray Roof Garden System Specification for further information regarding modular systems.

**NOTE: Access to water on the roof is required for this system and temporary or permanent irrigation is recommended.**

**NOTE: Exotic plants (plants other than sedums or groundcovers) and/or plants not supplied through Carlisle do not qualify for vegetation warranties.**

## B. Roof Garden Assemblies

### 1. Shallow (Extensive) Roof Garden System

Shallow Roof Garden System (growth media depth  $\geq 2.5$ " but  $< 5$ " ) is ideally suited for areas likely to receive little maintenance. Recommended plants include sedums and herbs. A temporary or permanent irrigation system is recommended in these assemblies. The anticipated weight above the membrane assembly is generally between 7 and 8 pounds per square foot, per inch of system depth, in a saturated state.

### 2. Medium Depth (Semi-Intensive) Roof Garden System

Medium Depth Roof Garden System (growth media depth of  $\geq 5$ " but  $< 8$ " ) includes plants such as sedums, herbs, grasses and other vegetation, which can grow in this depth of media. Drip, mist or spray irrigation systems may be required to support more diverse plant types or for installations in semi-arid climates. The anticipated weight above the membrane assembly is generally between 7 and 8 pounds per square foot, per inch of system depth, in a saturated state.

### 3. Deep (Intensive) Roof Garden System

Deep Roof Garden System (growth media depth of  $\geq 8$ " and greater) includes a variety of plants including turf grass, annual or perennial flowers, shrubs and small trees. This system will require regular maintenance, such as watering, fertilizing, mowing and weeding. This system typically requires a structural concrete roof deck to support the larger dead load. A temporary or permanent irrigation system is required in these assemblies. The anticipated weight above the membrane assembly is generally between 6.5 and 8 pounds per square foot, per inch of system depth, in a saturated state.

- C. The **Adhered Membrane Waterproofing Assemblies** incorporate a minimum 60-mil thick Sure-Seal EPDM, Sure-Weld TPO membrane, Sure-Flex PVC or Sure-Flex KEE HP, 115-mil FleeceBACK (EPDM, TPO, PVC, or KEE HP) membrane, 105-mil Sure-Seal AFX EPDM or 135-mil Sure-Weld AFX TPO membranes. Membrane will be adhered with appropriate adhesive to either a sloped structural concrete deck or tapered insulation with an acceptable cover board. To facilitate drainage a minimum roof slope of 1/4" in 12" must be provided at the waterproofing membrane level. Refer to Roof Garden (RG) Details included at the end of this specification for the various assembly options available.

## D. Alternative Roof Garden Systems

Refer to Carlisle Modular Tray Roof Garden System Specification, for further information regarding the following Roof Garden Modular Trays:

1. GreenGrid
2. Hydropack

## 1.02 General Design Considerations

- A. Projects where wind speed coverage greater than 55 mph is specified or those with a 20-year or longer Total System Warranty will require additional enhancements beyond those outlined in this section. Prior to installation, refer to Warranty Tables in Paragraph 1.05.
- B. Petroleum based products; certain chemicals and waste products (i.e. grease, oil, animal fats, etc.) are not compatible with these roofing systems. Carlisle should be contacted for verification of compatibility and recommendations concerning an acceptable roofing assembly.
- C. It is the responsibility of the Specifiers to review local, state and regional codes to determine their impact on the specified Carlisle Roofing System.

- D. It is the responsibility of the building owner or his/her designated representative to verify structural load limitation.
- E. Coordination between various trades is essential to avoid unnecessary rooftop traffic over completed sections of the roof and to prevent subsequent damage to the membrane roofing system.
- F. Concentrated loads from rooftop equipment may cause deformation of insulation/underlayment and possible damage to the membrane if proper protection is not provided. A protection course or sleepers must be specified.

### 1.03 Quality Assurance

Building Codes are above and beyond the intended purpose of this specification. The respective **owner** or **specifier** should consult local codes for applicable requirements and limitations. It is the responsibility of the specifier to review local, state and regional codes to determine their impact on the specified Carlisle Roofing System.

**NOTE: For code approvals** achieved with the Carlisle Roofing Systems, refer to the Carlisle Code Approval Guide, Factory Mutual (FM) Approval Guide or Underwriters Laboratories (UL) Fire Resistance or Roofing Materials and Systems Directories.

- A. Carlisle recommends the use of Carlisle supplied products for use with these Carlisle Roofing Systems. The performance or integrity of products by others, **when selected by the specifier and accepted as compatible by Carlisle**, is not the responsibility of Carlisle and is **disclaimed** by the Carlisle Warranty.
- B. The specified roofing system must be installed by a Carlisle Authorized Roofing Applicator in compliance with drawings and specifications as approved by Carlisle SynTec.
- C. There must be no deviations made from Carlisle's specification or Carlisle's approved shop drawings without the **PRIOR WRITTEN APPROVAL** of Carlisle SynTec.
- D. After completion of the installation, upon request, an inspection shall be conducted by a Field Service Representative (FSR) of Carlisle SynTec to ascertain that the membrane roofing system has been installed according to Carlisle's published specifications and details applicable at the time of bid. This inspection is to determine whether a warranty shall be issued. It is not intended as a final inspection for the benefit of the owner.
- E. Flood Testing, electronic testing or other leak detection means is required to check the waterproof integrity of the membrane prior to installing any above membrane components.
- F. An "In-Progress" inspection may be scheduled after the initial inspection (after the membrane installation is completed) to ensure proper protection procedures are being followed to prevent possible damage to the membrane during the installation of Roof Garden components.

**NOTE:** The roofing applicator must notify Carlisle at least 3 weeks in advance of the applicable inspection dates for coordination purposes.

### 1.04 Submittals

- A. To ensure compliance with Carlisle's minimum warranty requirements, **all projects should be forwarded to Carlisle for review prior to installation, preferably prior to bid.**
- B. Along with the project submittals (shop drawings and Request for Warranty), the roofing contractor must include pullout tests when results are below the requirements identified in this specification.
- C. Shop drawings must be submitted to Carlisle by the Carlisle Authorized Roofing Applicator along with a completely executed Notice of Award (Page 1 of Carlisle's Request For Warranty form) for approval. Approved shop drawings are required for inspection of the roof and on projects where on-site technical assistance is requested.

**Shop drawings must include:**

1. Outline of roof and size
2. Deck type (for multiple deck types)
3. Location and type of **all** penetrations
4. Perimeter and penetration details
5. Key plan (for multiple roof areas) with roof heights indicated

**Along with the project submittals** (shop drawing and Request for Warranty), the roofing contractor must include **pullout test** results when the results are below the requirements identified in, Table included in Design Reference DR-06-11 "Withdrawal Resistance Criteria".

When field conditions necessitate modifications to originally approved shop drawings, a copy of the shop drawing outlining all modifications must be submitted to Carlisle for revision and approval prior to inspection and warranty issuance.

- D. **As-Built Projects** (roofing systems installed prior to project approval by Carlisle)

**NOTE:** As-Built projects are not recommended for those projects referenced in Paragraph 1.04A in order to ensure Carlisle warranty requirements have been met.

- E. **Notice of Completion** (Page 2 of the Carlisle Request for Warranty form)

After project completion, a Notice of Completion must be submitted to Carlisle to schedule the necessary inspection of the project prior to issuance of the Carlisle Warranty.

### 1.05 Warranty

- A. **10, 15 or 20-year** System Warranty is available for a charge on commercial buildings and applies only to **products manufactured or marketed by Carlisle SynTec Incorporated**. The membrane system is defined as membrane, flashings, adhesives, sealants and other Carlisle brand products utilized in this installation. For a complete description of these products, refer to the "Products Section" or the applicable "Attachment" in the Carlisle Specifications.

When Carlisle Roof Garden components are specified and installed, for a nominal charge, a 10, 15, or 20 year Overburden Warranty can be added. The warranty covers all Carlisle Roof Garden components above the membrane limited to the protection fabric, polystyrene, drainage products, moisture retention mat, growth media and vegetation. In the event of a leak, Carlisle is responsible for overburden removal, roof repair and replacement of the overburden.

A Vegetation Warranty, which is a 2-year duration, is also available, for an additional charge, and covers replacement of plants for the specified duration of the warranty.

If a 20-year **Total System Warranty including overburden** is desired, it is recommended that a **Sustainable Roofing and Waterproofing Alliance (SRWA) Consultant** be utilized on the project, during the design and construction phases, on-site to monitor the installation.

- B. **See Table Below for information regarding Warranted Systems and Design Criteria:**

Table I

Roof Garden System Warranty Options(1)(5)

Roof Garden Assembly	Membrane Options for 10 or 15 Year Warranty	Membrane Options for 20 Year Warranty
<b>Shallow (Extensive) Roof Garden Assembly</b>	60-mil Sure-Seal EPDM (1)(2)	75-mil Sure-Tough EPDM (1)(2)
	60-mil Sure-Weld TPO, 60-mil Sure-Flex PVC or 60-mil Sure-Flex KEE HP (1)(3)(4)	80-mil Sure-Weld TPO, 80-mil Sure-Flex PVC or 60-mil Sure-Flex KEE HP (1)(3)(4)
	115-mil FleeceBACK EPDM (2) or 115-mil FleeceBACK TPO, PVC or KEE HP (3)(4)	145-mil FleeceBACK EPDM (2) or 135-mil FleeceBACK TPO, PVC or KEE HP (3)(4)
	105-mil AFX EPDM (1)(2) or 135-mil AFX TPO (1)(3) hot mopped directly to structural concrete	105-mil AFX EPDM (1)(2) or 155-mil AFX TPO (1)(3) hot mopped with two plies of base sheets directly over structural concrete
<b>Medium (Semi-Intensive) Roof Garden Assembly</b>	75-mil Sure-Tough EPDM (1)(2)	90-mil Sure-Seal EPDM (1)(2)
	80-mil Sure-Weld TPO or 80-mil Sure-Flex PVC or 80-mil Sure-Flex KEE HP (1)(3)(4)	80-mil Sure-Weld TPO or 80-mil Sure-Flex PVC or 80-mil Sure-Flex KEE HP (1)(3)(4)
	115-mil FleeceBACK EPDM (2) or 115-mil FleeceBACK TPO, PVC or KEE HP (3)(4)	145-mil FleeceBACK EPDM (2) or 135-mil FleeceBACK TPO, PVC or KEE HP (3)(4)
	105-mil AFX EPDM (1)(2) or 135-mil AFX TPO (1)(3) hot mopped with two plies of base sheets over structural concrete	105-mil AFX EPDM (1)(2) or 155-mil AFX TPO (1)(3) hot mopped with two plies of base sheets directly over structural concrete
<b>Deep (Intensive) Roof Garden Assembly (6)</b>	90-mil Sure-Seal EPDM (1)(2)	90-mil Sure-Seal EPDM (1)(2)
	80-mil Sure-Weld TPO or 80-mil Sure-Flex PVC or 80-mil Sure-Flex KEE HP (1)(3)(4)	Contact Carlisle
	115-mil FleeceBACK EPDM (2) or FleeceBACK TPO, PVC, or KEE HP (3)(4) adhered with Flexible FAST Adhesive directly over structural sloped concrete	145-mil FleeceBACK EPDM (2) or 135-mil FleeceBACK TPO, PVC, or KEE HP (3)(4) adhered with Flexible FAST Adhesive directly over structural concrete
	105-mil AFX EPDM (1)(2) or 135-mil AFX TPO (1)(3) hot mopped with two plies of base sheets over structural concrete	Contact Carlisle

- (1) When positive slope is incorporated by tapered insulation, non-FleeceBACK or AFX membranes may be adhered to a coverboard (DensDeck Prime or Securock) which has been adhered to the insulation with Carlisle Insulation Adhesive. For Membrane seams for FleeceBACK and AFX membranes, follow notes 2 thru 4.
- (2) Sure-Seal and Sure-Tough EPDM Membranes shall be seamed with 3" or 6" Factory Applied Tape and overlaid with 6" Pressure-Sensitive Cured Cover Strip.
- (3) Sure-Weld TPO Membrane seams shall be heat-welded and overlaid with 6" TPO Pressure-Sensitive Cover Strip.
- (4) Sure-Flex PVC and KEE HP Membrane seams shall be heat-welded and overlaid with a 6" PVC Pressure Sensitive Cover Strip and utilize the PVC 2-step priming process.
- (5) An approved coverboard is required when insulation is used above structural deck.
- (6) 20 Year Warranty - Deep Assemblies require a 12" wide Pressure-Sensitive Cover Strip (EPDM) or 12" wide Heat-Welded or Pressure-Sensitive Cover Strip/Membrane (TPO) or 12" wide Heat-Welded Cover Strip/Membrane (PVC/KEE HP).

### C. Access for warranty service

If a 10, 15 or 20-year Overburden Warranty is not obtained or if the owner chooses to use overburden by others, it shall be the owner's responsibility to expose the waterproofing membrane assembly in the event warranty service or investigation is necessary. Overburden Warranty covers removal and replacement of the Carlisle supplied products.

- D. The formation or presence of mold or fungi in a building is dependent upon a broad range of factors including, but not limited to, the presence of spores and nutrient sources, moisture, temperatures, climatic conditions, relative humidity, and heating/ventilating systems and their maintenance and operating capabilities. These factors are beyond the control of Carlisle and Carlisle shall not be responsible for any claims, repairs, restoration or damages relating to the presence of any irritants, contaminants, vapors, fumes, molds, fungi, bacteria, spores, mycotoxins, or the like in any building or in the air, land, or water serving the building.

## 1.06 Job Conditions

- A. On phased roofing, temporary closures should be provided to prevent moisture infiltration. When a temporary roof is specified, Carlisle VapAir Seal 725TR in conjunction with CCW-702 or CAV-GRIP III Primer may be used. Refer to Product Section Part II for additional product information and Specification Supplement G-08-20.
- B. When possible on multiple level roofs, begin the installation on the highest level to avoid or minimize construction traffic on completed roof sections.
- C. Vapor Retarders
1. Carlisle does not require a vapor retarder for the protection of the membrane; however, the following criteria should be considered by the specifier:
    - a. Use of a vapor retarder to protect insulation and reduce moisture accumulation within an insulated roofing assembly, should be investigated. Consult latest publications by ASHRAE (American Society of Heating, Refrigerating and Air-Conditioning Engineers, Inc.) and NRCA (National Roofing Contractors Association) for specific information.
    - b. In the generally temperate climate of the United States, during the winter months, water vapor flows upward from a heated, more humid interior toward a colder, drier exterior. Vapor retarders are more commonly required in northern climates than in southern regions, where downward vapor pressure may be expected and the roofing membrane itself becomes the vapor retarder.
- D. Wood nailers are required for the securement of metal edgings, scuppers, and insulated pipes. Wood Nailer shall be secured per specifier recommendation or in accordance with Factory Mutual's property Loss Prevention Data Sheet 1-49. Refer to Design Reference DR-08-11 "Wood Nailers Securement Criteria" in Carlisle Technical Manual shall be referenced.
- E. When any of the Roofing Systems are specified on a portion of a roof, tie-ins to existing roofing membranes will be required. Depending on the type of the existing roofing system, the tie-in method will vary. Total isolation between two roofing systems or weep holes may be required to address moisture migration from one roofing system to the other. Prior to the selection of any tie-in detail, ensure the selected detail will not restrict drainage.
- F. On new construction projects, located in colder climates, special consideration should be given to construction practices and the possible migration of hot, humid air and moisture generated during construction. Refer to Spec Supplement G-01-18 "Construction Generated Moisture".
- G. For Additional Job Condition information, consult the appropriate roofing membrane specification.

## 1.07 Product Delivery, Storage and Handling

- A. Deliver materials to the job site in the original, unopened containers.

- B. When loading materials onto the roof, the Carlisle Authorized Roofing Applicator must comply with the requirements of the specifier/owner to prevent overloading and possible disturbance to the building structure.
- C. Job site storage temperatures in excess of 90° F (32°C) may affect shelf life of curable materials (i.e. adhesives and sealants).
- D. **When the temperature is expected to fall below 40° F (5°C)**, outside storage boxes should be provided on the roof for temporary storage of liquid adhesives and sealants. Adhesives and sealant containers should be rotated to maintain their temperature above 40°F (5°C).
- E. Carlisle Growth Media should be stored under cover whenever possible to avoid direct sunlight exposure and excessive moisture absorption to the Super Sacks®, in which the material is delivered. Direct sunlight can breakdown the integrity of the Super Sack and excessive moisture will increase the overall weight and possibly overload the lift straps of the sack. Care should be taken to not damage the packaging to avoid leakage when hoisted to the rooftop.
- F. Carlisle Roof Garden Plants, when specified, should be planted promptly after delivery to the jobsite. Plugs should be unpacked immediately upon arrival and planted within three (3) days. Vegetated Sedum Tiles and Mats should be unpacked and installed within 36 hours. Unused plugs and tiles should be stored in an outdoor location with access to at least four (4) hours per day of direct sunlight.
- G. MiraDRAIN G4 drainage composite must be installed with green/white side up to maintain the water retention cups facing the plants.
- H. Consult the appropriate membrane specification for additional delivery, storage and handling information.

## PART II – PRODUCTS

### 2.01 General

The components of this roofing system are to be products of Carlisle. The installation, performance or integrity of products by others, **when selected by the specifier and accepted by Carlisle**, is not the responsibility of Carlisle and is expressly disclaimed by the Carlisle warranty.

### 2.02 Membrane/Related Products

#### A. Membranes

Sure-Seal EPDM (black), Sure-White EPDM (white), Sure-Weld TPO, Sure-Flex PVC/KEE HP, FleeceBACK EPDM, FleeceBACK TPO, FleeceBACK PVC/KEE HP, AFX EPDM and AFX TPO can be used with this system. Refer to Paragraph 1.05, Design Guidelines for required membrane thickness that is dependent upon the type of Roof Garden and warranty selected. For membrane physical properties, refer to the appropriate Carlisle Product Data Sheets.

#### B. Related Products

1. **Sure-Seal/Sure-White Products:** Sure-Seal Bonding Adhesive, Low VOC Bonding Adhesive, Flexible FAST Adhesive, Cold Applied Adhesive, Aqua Base 120 Adhesive, SecurTAPE, EPDM Primer, Low VOC EPDM Primer, Lap Sealant, Universal Single-Ply Sealant, Weathered Membrane Cleaner, Cured EPDM Flashing, Cured Cover Strip, Pressure-Sensitive Overlayment Strip, Elastoform Flashing, Termination Bars, Fasteners/Plates, Water Cut-Off Mastic, Pourable Sealer, Walkway Pads/Rolls, Pre-molded Pipe Seals, and Pressure Sensitive Inside/Outside Corners are used depending on the waterproofing assembly.
2. **Sure-Weld Products:** Sure-Weld Flashing, Sure-Weld Bonding Adhesive, Low VOC Bonding Adhesive, Flexible FAST Adhesive, Cold Applied Adhesive, Aqua Base 120 Adhesive, Cut-Edge Sealant, Water Cut-Off Mastic,

Universal Single-Ply Sealant, TPO Molded Pocket Sealant, Weathered Membrane Cleaner, Pressure-Sensitive Cover Strip, Coated Metal, Heat Weldable Walkway Rolls, Pre-Molded Accessories, TPO Primer, Low VOC TPO Primer, Termination Bars, and Fasteners/Plates are used depending on the waterproofing assembly.

3. **Sure-Flex PVC/KEE HP Products:** Sure-Flex Low VOC PVC Bonding Adhesive, Sure-Flex PVC non-reinforced Flashing, Sure-Flex PVC "T" Joint Cover, Sure-Flex PVC Cut Edge Sealant, Water Cut-Off Mastic, Universal Single-Ply Sealant, White One-Part Pourable Sealer, PVC and KEE HP Membrane Cleaner, Sure-Flex Low-VOC PVC Step 1 Activator, Sure-Flex Low-VOC PVC Step 2 Primer, Sure-Flex PVC Step 2 Primer, Sure-Flex PVC Coated Metal, Sure-Flex PVC Inside/Outside Corners and Sure-Flex Pre-Molded accessories are used depending on the waterproofing assembly.
4. **Other Carlisle Products:** Insulation, Edgings and copings are also required when such components are to be included as part of the System Warranty.

### 2.03 Carlisle Roof Garden Components

#### A. Carlisle Roof Garden Plants

1. **Vegetated Sedum Mats** – Carlisle's Vegetated Sedum Mats are available in 25 square foot rolls depending on project's geographic location. Mats enable full vegetative coverage on the day of installation with the fastest possible installation time. Carlisle's Vegetated Sedum Mats weigh approximately 5.5 pounds per square foot in a saturated state and are planted with standard varieties of sedum (refer to product data sheets for specific varieties) which are selected based on the project's USDA Plant Hardiness Zone. Custom Sedum Mat mixes are available, upon request, for an additional cost. Refer to Product Data Sheets for more information.
2. **Vegetated Sedum Tiles** – Carlisle's Vegetated Sedum Tiles are available in 2 square foot pieces. Designed to enable rapid installation and ensure full (95%+) vegetated coverage on the day of installation. Each tile weighs approximately 11 pounds (5.48 pounds per square foot, saturated) and is planted with multiple varieties of sedum. Two standard mixes of sedums for the tiles are available and are suitable for USDA Plant Hardiness Zones 3-8. Custom sedum tiles are available, upon request, for an additional cost. Refer to Product Data Sheets for more information.
3. **Plugs** – Carlisle plant plugs are available in 10" x 20" flats/trays containing either twenty four (24) 2-1/2" diameter plugs or seventy-two (72) 1-1/2" diameter plugs. Plant selection is based on the project's USDA Plant Hardiness Zone. Refer to Product Data Sheets for more information.

- B. **Carlisle Growth Media** – is available in different blends based on geography and depth requirements for plant growth. These blends are engineered specifically for roof gardens to be lightweight, resistant to decomposition, and high water holding capacity while maintaining air porosity within the growth media. Carlisle Growth Media is blended to strict FLL-compliant standards. Each blend is packaged in 1.35 to 2.0 cubic yard Super Sacks<sup>®</sup> weighing 1,450 to 3,000 pounds. Refer to specific growth media blend specification sheets, based on growth media and regional location, or Contact Carlisle.
- C. **MiraDRAIN G4 Drainage Composite** - Consists of a polypropylene core with "cups" and high-flow overflow drains. A non-woven 100% post-consumer recycled polyester combination filter fabric and green moisture retention mat is bonded to the retention side of the molded core to prevent passage of particles into the water reservoirs. Designed to filter and retain water in all Roof Gardens while allowing excess water to quickly reach the drainage system. Drainage composite is 1.21" thick and holds up to 0.32" of rainfall (0.2 Gallons) per square foot. Packaged in 4' x 50' rolls weighing 70 pounds. This composite is to be installed green side up, allowing the moisture retention cups to face plants.
- D. **Protection Fabric – Carlisle CCW 300HV** – (16 oz/yd<sup>2</sup>) is a polypropylene non-woven needle-punched fabric that is stabilized to resist soil chemicals, mildew, and insects and is non-biodegradable. Designed to prevent abrasion to the

membrane when a root barrier is used in Intensive and Extensive Roof Garden assemblies. Available in 12.5' x 300' and 40" x 200' rolls.

#### E. **Root Barriers**

1. **Root Barrier** – Carlisle 40-mil non-reinforced polypropylene sheet specifically formulated for use in below grade and vegetated application to resist root growth and soil bacteria. Used in Deep (Intensive) and Medium Depth (Semi-Intensive) Roof Garden Systems. Available in widths of 12' and lengths of 100'.
2. **Biobarrier** – In certain Deep (Intensive) Roof Garden applications, Biobarrier synthetic hormone root barrier is used in selective areas. Biobarrier repels root growth, discouraging contact with waterproofing membrane. Biobarrier is available in 12" x 100' rolls and 58.5" x 100' rolls. Contact Carlisle when considering special planting choices.

#### F. **Polystyrene Insulation (available from Carlisle) (Above the Membrane)**

1. **Insulfoam DB** is a minimum 40 psi compressive strength, moisture resistant, closed cell expanded polystyrene with a 1/4" x 1/4" drainage channels every 2" o.c. Installed directly over the roof membrane in Intensive (deep) garden assemblies. Available in 4' x 4' and 4' x 8' board sizes with a thickness of 1" to 40". Readily available in custom lengths and widths.
2. **Dow Roofmate or Foamular 404/604** is a minimum 40/60 psi compressive strength, moisture resistant, closed cell polystyrene foam insulation with drainage channels along board edges to promote drainage at the membrane level. Installed directly over the roof membrane in Intensive (deep) garden assemblies. Available in 2' x 8' board sizes with a thickness of 1" to 4".

G. **Carlisle Roof Garden Edge** – a 0.080" thick extruded aluminum edge used to separate roof garden assemblies from adjacent walkways or perimeter stone ballast. The edging is available in 10' lengths and 4", 6" and 8" high (growth media heights). Additional heights are available from Carlisle.

H. **Carlisle Easy Bend Roof Garden Edge** – a 0.080" thick extruded aluminum edge used to separate roof garden assemblies from adjacent walkways or perimeter stone ballast. The edging is pre-notched to easily from curved shapes. The edging is available in 10' lengths and 4", 6", and 8" high (growth media heights). Additional heights are available, contact Carlisle.

I. **Carlisle Aluminum Roof Garden Drain Box** – a 0.125" thick extruded aluminum drain box that is 11-1/2" x 11-1/2" with a 3-1/4" flange to keep the drain areas clear of stone ballast or growth media. The drain box is available in 4" or 8" and 12" heights. Drainage holes are pre-punched around the sides. Access to the drain is provided by a removable lid. Custom sized Drain Boxes are available from Carlisle, for an additional cost.

#### J. **Hanover Architectural Products (available through Carlisle)**

1. **Hanover Prest Pavers** – 2' x 2' x 2" thick precast concrete pavers weighing 25 psf with compressive strength of 8500 psi. Absorption is less than 5% and Flexural is 1,100 psi. Available in eight (8) standard colors. Custom colors and custom made sizes available.
2. **Hanover Pedestal Paver** – 2' x 2' x 2.25" thick precast concrete pavers weighing 22 psf and an elevated clearance of 1/2" from incorporated footing.
3. **Hanover Guardian Paver** – Developed for high wind and special conditions, this paver utilizes a three-piece pedestal system and shaped paver. The paver is 2' x 2' and available in 2" or 3" thicknesses and weighs 25 psf to 38 psf.

4. **Hanover RockCurb** – Transition component between paver system/hardscaped areas and adjoining roof garden assembly. RockCurb is 6" thick and 36" long, and is available in 12" height with a battered profile or in an 18" height with a battered profile or bull nose profile. Radius sections are also available.
  5. **Hanover Paver Accessories** – High Tab Pedestal with shims, EPDM Pedestal with shims, Compensator, Elevator Couples, and Elevator Pedestal.
- I. **Sunny Brook Pavers (available through Carlisle)** - Pre-cast concrete pavers used in conjunction with roof garden applications or for ballasted roof applications. 23-1/2" x 23-1/2" x 2" thick precast concrete pavers weighing 24 psf. Available in 17 standard colors, with special order colors available. The pedestal paver can either be installed in conjunction with a separation layer of HP Protective Mat or using MRP Pedestal and shims.
  - J. **Carlisle Stained Glass Stone** – Stained Glass Stone is 100% post-consumer recycled & tumbled glass in a 1-2" particle size used as a special effects accessory for Roof Gardens and Plazas. Available in 12 different colors, Stained Glass Stone can be utilized around perimeters, penetrations or even to create colorful logos in any size or shape. Stained Glass Stone is applied at a minimum rate of 10 pounds per square foot over a minimum 1" thick drainage composite such as Carlisle MiraDRAIN G4.

#### 2.04 Other Non-Carlisle Products (Not covered by Carlisle Warranty)

##### A. "Hardscaped" Items:

1. **Stone Ballast** – Nominal 1-1/2" diameter rounded water worn gravel which conforms to ASTM D448, gradation size #4, applied at a minimum of 10 pounds per square foot.
2. **Other** – Products such as concrete curbs, landscape lumber (wood timbers, etc.) or other desired landscape products suitable for this application. Used to transition between roof garden and hardscaped areas to act as a "growth media stop".

### PART III – EXECUTION

#### 3.01 General

When feasible, begin the application at the highest point of the highest roof level and work to the lowest point to prevent moisture infiltration and to minimize construction traffic on completed sections. This will include completion of all flashings and terminations.

#### 3.02 Roof Deck Criteria

Proper decking shall be provided by the building owner. The building owner or its designated representative must ensure that the building structure is investigated by a registered engineer to assure its ability to withstand the total weight of the specified roofing system, as well as construction loads and live loads, in accordance with all applicable codes. The specifier must also designate the maximum allowable weight and location for material loading and storage on the roof.

- A. For **Shallow (Extensive)** (growth media depth  $\geq 2.5"$  but  $< 5"$ ) **Roof Garden Systems**, any roof deck capable of withstanding the roof loading may be accepted.
- B. For **Medium (Semi-Intensive)** (growth media depth of  $\geq 5"$  but  $< 8"$ ) and **Deep (Intensive)** (growth media depth  $\geq 8"$  and greater) **Roof Garden Systems**, structural concrete roof decks are recommended due to increased weight of the roof assembly when the system is at its maximum water capacity.
- C. Defects in the roof deck must be reported and documented to the specifier, general contractor and building owner for assessment. The Carlisle Authorized Roofing Applicator shall not proceed unless the defects are corrected.

### 3.03 Substrate Preparation

The substrate must be dry, relatively smooth and free of protrusions, debris, sharp edges or foreign materials and must be free of accumulated water, ice and snow. Cracks or voids in the substrate greater than 1/4" (6mm) must be filled with a suitable material.

### 3.04 Waterproofing Installation

Before beginning installation, refer to the applicable Safety Data Sheets, OSHA safety requirements, and Product Data Sheets for cautions and warnings.

#### A. Insulation Attachment

1. Base layer of insulation can be mechanically attached with acceptable Carlisle Fasteners and Insulation Plates. Refer to appropriate Roofing Membrane Specification for acceptable decks and the specific Carlisle Fasteners to be used.
2. Fastening Density is determined by insulation type and thickness, as well as possible required enhanced fastening as prescribed by Factory Mutual Global, ANSI/SPRI WD-1 or Miami-Dade County. Refer to Spec Supplement G-09-20 "Insulation Attachment and Details" for standard fastening and Design Reference DR-05-19 "Insulation Fastening Patterns" for enhanced fastening.
3. As an alternate to mechanically attaching the base layer of insulation, Carlisle Flexible FAST Adhesive can be used. Refer to appropriate Roofing Membrane Specification for installation using Flexible FAST Adhesive.
4. Top layer of insulation must be an acceptable (min. 1/2") cover board adhered with Flexible FAST Adhesive. Refer to appropriate Roofing Membrane Specification for installation procedures.

#### B. Membrane Installation

1. Sure-Seal/Sure-White, Sure-Tough, Sure-Weld, Sure-Flex (PVC/KEE HP), FleeceBACK (EPDM, TPO or PVC/KEE HP) or AFX (EPDM or TPO) Adhered Roofing Systems may be adhered with appropriate adhesive to either sloped structural concrete deck, tapered insulation with an acceptable cover board or wood decks. Direct application over cellular or perlite insulating concrete may also be specified (Contact Carlisle SynTec for acceptable lightweight insulating concretes). See Roof Deck Criteria in Section 3.02 of this Specification for restrictions.
2. For installation procedures on Adhered Roofing Systems, refer to appropriate "Installation" Section of individual membrane Specifications.

#### C. Membrane Splicing

1. Refer to appropriate splicing procedures published in the individual membrane Specifications as well as Spec Supplement E-02-20 "EPDM Membrane Splicing and Splice Repairs" for EPDM specifically.
2. In addition to the standard splice procedure all field splices shall be overlaid with the appropriate 6" EPDM or TPO Pressure-Sensitive Cover Strip. For PVC/KEE HP membrane use a 6" PVC Pressure Sensitive Cover Strip and utilize the PVC 2-step primer process.
3. Prior to Pressure-Sensitive Cover Strip application, the splice area must be primed with EPDM or TPO Primer, depending on membrane used. For PVC/KEE HP membrane utilize the PVC 2-step primer process.

#### D. Flashing

1. Walls, curbs, skylights and all other penetrations through the membrane must be flashed in accordance with Carlisle's published specifications and details for the applicable membrane specified.
2. Flashing heights shall be greater in height than the specified depth of the Roof Garden assembly (Drainage composite, growth media, etc.).
3. Vertical field splices at walls, curbs, etc., must be overlaid in the same fashion as the field splices.

#### E. Roof Drains

1. Roof garden drains should be covered with a Carlisle Aluminum Drain Box or a perforated drain box by others with removable lid (at growth media surface height) for inspection purposes. 1-1/2" nominal diameter rounded river washed gravel is applied around the drain box a minimum of 24" (horizontally) to promote drainage.
2. In Shallow (Extensive) and Medium Depth (Semi-Intensive) Roof Garden Waterproofing assemblies, standard, cast iron, compression ring clamping drains may be used with 1-1/2" nominal diameter rounded river washed gravel applied around the drain sump area (minimum 24" in width) for drainage.
3. When using protection fabric, end fabric at base of drain to avoid clogging of roof drain with growth media, especially if growth media by others is used.

### 3.05 Roof Garden Installation

#### A. Prior to installation of Roof Garden Components

1. Limit floor traffic over completed waterproofing system. Heavily traveled areas (staging areas, corridors used to transport roof garden components) must be protected.
2. Perform a Flood Test or Electronic Test to ensure the watertight integrity of the waterproofing system. Testing should take place after the membrane and flashings have been in place a minimum of 24 hours. Plug drains and provide necessary barriers to contain water.
3. "Flood Test" the membrane surface with water for 48 hours at a minimum depth of 2". Inspect for leaks and repair membrane if damage to waterproofing assembly is found. Retest after repairs have been made.

**Note:** Although it is not required, it is recommended, electronic testing such as Electric Field Vector Mapping (EVFM) may be used to test membrane for defects. Contact Carlisle for the appropriate testing agency and procedures.

4. Documentation of the Flood Test should be completed by the designer or roof consultant and signed by the building owner. This documentation should be sent to Carlisle as part of the Notice of Completion for warranty inclusion.
5. Contact Carlisle to Schedule FSR Inspection of roof prior to commencement of the roof garden installation.
6. Sweep the surface of the membrane to remove all debris and loose or foreign material.
7. Roofs with Slopes 2:12 or greater will require an additional layer of 6" Pressure Sensitive Flashing beneath all aluminum edging.
8. Calculation of "Vegetation-Free" Zone shall comply with one of the following methods:

- a. Use distance calculated with ANSI/SPRI RP-14 “Wind Design Standard for Vegetative Roofing Systems” for the entire roof design.
- b. Use a minimum of two (2) feet from all corners and perimeters where a parapet wall is not present with the addition of an erosion control blanket extending the remainder of the required “vegetation-free” distance calculated using the ANSI/SPRI RP-14 “Wind Design Standard for Vegetative Roofing Systems”.
- c. Designer or Roof Consultant may select their own distance for the “vegetation-free” zone for all perimeters and corners where a parapet wall is not present. Designer or Roof Consultant will then be liable for any damage that may occur due to wind erosion at the specified distance.
- d. Contact Carlisle for design recommendations.

## **B. Shallow (Extensive) Roof Garden Installation**

### **1. Aluminum Edging**

- a. Prime waterproofing membrane and edging with appropriate membrane primer (i.e. EPDM Primer, TPO Primer). For PVC/KEE HP membrane, prime with Low-VOC PVC Step 1 Activator and PVC or Low-VOC PVC Step 2 Primer.
- b. Align aluminum edge with bottom flange toward growth media.
- c. Adhere edging directly to waterproofing membrane using 3” wide Pressure Sensitive SecurTAPE (white or black).

**Caution:** Remove any burrs or sharp edges that may be present from the cutting (field or factory) process.

### **2. Vegetation-Free Zone (Ballast) Installation**

- a. Install ballast between aluminum edging, vertical and horizontal surfaces, as required for offset dimension, listed below.
  - i. Minimum 24” offset for Parapets, Vertical walls, HVAC Unit Curbs, standard Skylights and Drains.
  - ii. Minimum 12” offset for Pipe Penetrations, Expansion Joints and Tubular Skylights.
- b. Install ballast at all exposed roof edge conditions, where vertical surfaces do not occur.
  - i. Use distance determined by method of calculation of “vegetation-free” zone as described in Paragraph A7.
- c. When using concrete pavers as ballast, follow local Building Code and Occupational Safety and Health Administration (OSHA) Guidelines for Fall Protection.

**Caution:** Provide measures at walkways and roof access points for snow and ice removal.

### **3. MiraDRAIN G4 Drainage Composite**

- a. Unroll the drainage composite and flip over, confirm the green or white moisture retention mat is facing upwards. Moisture retention cups should be facing up towards the plants.
- b. Place drainage composite directly over the waterproofing membrane with the, built-in, overlapping flap facing the direction of the slope.

- c. Position additional drainage composite rolls next to each other with green moisture retention mat butted against the long side. Once in place, flip 6" retention mat flap over the first drainage composite. For runs of MiraDRAIN G4 exceeding 50 feet in length, peel back both fabrics approximately 3" on the adjacent ends of the rolls and insert two rows of the MiraDRAIN "cups" into the cups of the abutting roll. This locks the MiraDRAIN rolls together and does not allow for passage of growth media directly onto the waterproofing membrane.

#### 4. Carlisle Growth Media

- a. Hoist growth media in Super Sacks by crane to the roof area that is receiving the Roof Garden.
- b. Distribution of the Carlisle Growth Media shall be directly over the MiraDRAIN G4 Drainage Composite from Super Sacks that are lowered by crane 2' to 4' above the drainage composite. (Note: Growth Media may also be applied over a Carlisle approved drainage system.)
- c. Slit the bottom of the sack with a knife or other cutting device to dispense the growth media directly over the drainage composite or into wheelbarrows. For transporting to hard-to-access areas.

**Caution:** Location points for distribution of growth media must not overload the structural capacity of the building.

- d. Coverage rate per 2 cubic yard sack, for a shallow assembly is approximately 140 square feet for a 4" media depth and for 1.5 cubic yard sack, approximately 104 square feet for a 4" media depth, when properly compacted.

**Caution:** Care must be taken when distribution of Carlisle Growth Media is during windy conditions to limit potential scouring of media. If growth media is not used on the day of arrival, product should be stored under a tarp or other opaque cover to prevent direct exposure to sunlight and moisture.

**Note:** As an alternative to Super Sacks, growth media may be purchased in bulk and blown onto the roof utilizing a blower truck. For information please contact Carlisle.

- e. Compact installed growth media by rolling with a 250 pound weighted roller in the field and a hand tamper around perimeter and corners, 12-18% compaction is to be expected.

#### 5. Carlisle Roof Garden Plants

Refer to Product Data Sheets for specific plants based on types and hardening zone.

##### Vegetative Plugs

- a. Water growth media prior to installation of vegetative plugs and ensure media remains moist and cool in all areas during installation.
- b. Place plug trays in the vicinity of where planting has been specified.
- c. If 2.5" diameter plugs are planted, spacing is recommended 8" on center (2.25 plugs per square foot).
- d. If 1.5" diameter plugs are planted, spacing is recommended 6" on center (4 plugs per square foot).
- e. Make a 2" deep indentation into the growth media and insert plug.
- f. Tamp the growth media around the base of the plug by hand to ensure that plug is securely buried.

- g. Water the Roof Garden assembly by hand or sprinkler(s) until the system is saturated.

#### **Vegetated Mats**

- a. Water growth media prior to installation of vegetated mats and ensure media remains moist and cool in all areas during installation.
- b. Lift the 25 square foot rolls from the pallets and unroll the mats directly over the growth media.
- c. Unroll Vegetated Mats adjacent to each other with edges butted together to within 1/4".
- d. Continue with placement of vegetated mats until the designated roof garden area is covered.
- e. Water the Roof Garden assembly by hand or sprinkler(s) until the system is saturated.

#### **Vegetated Tiles**

- a. Water growth media prior to installation of vegetated tiles and ensure media remains moist and cool in all areas during installation.
- b. Remove tile from container with care and lay directly onto the growth media.
- c. Place additional vegetated tiles with edges butted together to within 1/4".
- d. Continue with placement of vegetated tiles until the designated roof garden area is covered.
- e. Water the Roof Garden assembly by hand or sprinkler(s) until the system is saturated.

### **C. Medium (Semi-Intensive) Roof Garden Installation**

#### **1. CCW 300HV Protection Fabric**

- a. Unroll protection fabric directly over the waterproofing membrane.
- b. Position the next roll of protection fabric to overlap the first, a minimum of 2".
- c. Install consecutive rolls in a similar fashion.

**Caution:** End fabric at base of roof drains to avoid clogging of drains with growth media, especially if growth media by others is used.

#### **2. Root Barrier**

- a. Unroll root barrier over the protection fabric.
- b. Position the next roll of root barrier to overlap the first, a minimum of 3".
- c. Clean splicing area with Carlisle Weathered Membrane Cleaner to remove any dirt/contaminants.
  - i. Root barrier sheets shall be spliced together by a heat welder.
  - ii. Seaming root barrier with a heat welder refer to Thermoplastic Specification, Section 3.06 Heat Welding Procedures, as well as Spec Supplement T-01-18 "Heat Welding Equipment".

- d. Extend root barrier up walls, curbs, etc. beyond the height of the top of the growth media depth. At drain areas extend root barrier a minimum of 3" past aluminum edging.

**Caution:** Placement of root barrier must not impede drainage for the roof area. Root Barrier is to be loose laid and **not** welded or adhered with SecurTAPE to membrane.

### 3. Edging Installation

- a. Prime waterproofing membrane and edging with appropriate membrane primer (i.e. EPDM Primer, TPO Primer). For PVC/KEE HP membrane, prime with Low-VOC PVC Step 1 Activator and PVC or Low-VOC PVC Step 2 Primer.
- b. Align aluminum edge with bottom flange toward growth media.
- c. Adhere edging directly to waterproofing membrane using 3" wide Pressure Sensitive SecurTAPE (white or black).

**Caution:** Remove any burrs or sharp edges that may be present from the cutting (field or factory) process.

### 4. Vegetation-Free Zone (Ballast) Installation

- a. Install ballast between aluminum edging and horizontal surfaces, as required for offset.
  - i. Minimum 24" offset for Parapets, Vertical walls, HVAC Unit Curbs, standard Skylights and Drains.
  - ii. Minimum 12" offset for Pipe Penetrations, Expansion Joints and Tubular Skylights.
- b. Install at all exposed roof edge conditions, where vertical surfaces do not occur.
  - i. Use distance determined by method of calculation of "vegetation-free" zone as described in Paragraph A7.
- c. When using concrete pavers as ballast, follow local Building Code and Occupational Safety and Health Administration (OSHA) Guidelines for Fall Protection.

**Caution:** Provide measures at walkways and roof access points for snow and ice removal.

### 5. MiraDRAIN G4 Drainage Composite

Refer to article 3.05-B2 for installation instructions.

### 6. Carlisle Growth Media

Refer to Article 3.05-B3 for installation instructions of growth media with the following exception: Coverage rate per 2 cubic yard Super Sack for Medium Roof Garden is approximately 92 square feet for a depth of 6" and for 1.5 cubic yard sack, the rate is approximately 69 square feet for a depth of 6".

### 7. Carlisle Roof Garden Plants

- a. Refer to Article 3.05-B4 for installation of roof garden plants.
- b. Refer to Product Data Sheets for specific plants based on types and hardening zones and options for planting of plugs, vegetated tiles or vegetated mats **or regionally specific perennial plants.**

#### D. Deep (Intensive) Roof Garden Installation

##### 1. Carlisle Expanded or Extruded Polystyrene (minimum 2" thick with drainage channels)

- a. Loose lay insulation board directly over the waterproofing membrane with channeled side facing down.
- b. Insulation boards shall be butted with no gaps greater than 1/4".

**Note:** As an alternate to the referenced insulation boards, CCW 300HV Protection Fabric may be used. Refer to article 3.05-C1 for installation instructions.

##### 2. Root Barrier

Refer to article 3.05-C2 for installation and seaming instructions with the following addition: Root Barrier shall be loose laid over the protection fabric or polystyrene insulation.

##### 3. Edging Installation

- a. Prime waterproofing membrane and edging with appropriate membrane primer (i.e. EPDM Primer, TPO Primer). For PVC/KEE HP membrane, prime with Low-VOC PVC Step 1 Activator and PVC or Low-VOC PVC Step 2 Primer.
- b. Align aluminum edge with bottom flange toward growth media.
- c. Adhere edging directly to waterproofing membrane using 3" wide Pressure Sensitive SecurTAPE (white or black).

**Caution:** Remove any burrs or sharp edges that may be present from the cutting (field or factory) process.

##### 4. Vegetation-Free Zone (Ballast) Installation

- a. Install ballast between aluminum edging and horizontal surfaces, as required for offset. See Roof Garden Details for additional information.
  - i. Minimum 24" offset for Parapets, Vertical walls, HVAC Unit Curbs, standard Skylights and Drains.
  - ii. Minimum 12" offset for Pipe Penetrations, Expansion Joints and Tubular Skylights.
- b. Install ballast at all exposed roof edge conditions, where vertical surfaces do not occur. See Roof Garden Details for additional information.
  - i. Use distance determined by method of calculation of "vegetation-free" zone as described in Paragraph A7.
- c. When using concrete pavers as ballast, follow local Building Code and Occupational Safety and Health Administration (OSHA) Guidelines for Fall Protection.

**Caution:** Provide measures at walkways and roof access points for snow and ice removal.

##### 6. MiraDRAIN G4 Drainage Composite

Refer to article 3.05-B2 for installation of the drainage composite with the following addition: When the drainage composite is installed over polystyrene insulation, stagger joints in drainage composite and insulation a minimum of 6".

## 7. **Carlisle Growth Media**

Refer to article 3.05-B3 for installation instruction of growth media with the following exception:  
Coverage rate per 2 cubic yard Super Sack for deep assemblies are 70 square foot at a depth of 8" and for 1.5 cubic yard sack, the rate is 52 square foot at a depth of 8".

## 8. **Carlisle Roof Garden Plants**

For Intensive Roof Garden Assemblies, typically, more planting options would be sourced locally through regional growers or vendors, due to the diverse availability of plantings, Contact Carlisle.

### **3.06 Night Seal**

On phased roofing, when the completion of flashings and terminations is not possible by the end of each workday, provisions must be taken to temporarily close the membrane to prevent water infiltration. Refer to Spec Supplement G-07-20 "Daily Seal / Clean Up".

### **3.07 After installation of Roof Garden Components**

- A. Irrigate the Roof Garden with a lawn sprinkler, hand sprayer, or with a designated irrigation system until saturation, to the point of runoff.
- B. Refer to Roof Garden Attachment I "Roof Garden Care & Maintenance Requirements" for maintenance recommendations.

Copyright 2025 Carlisle SynTec Systems

Carlisle, Sure-Seal, Sure-White, Sure-Tough, Sure-Weld, Sure-Flex, FleeceBACK, SecurTAPE, and In-Seam Sealant are trademarks of Carlisle SynTec Systems  
MiraDRAIN is a trademark of Carlisle Coatings & Waterproofing

Super Sack is a trademark of B.A.G. Corporation

Carlisle SynTec Systems  
P.O. Box 7000  
Carlisle, PA 17013  
800-479-6832



## Traditional

“Attachment I”

### Roof Garden Care & Maintenance Requirements

July 2025

#### Introduction

Carlisle Roof Gardens can be a low maintenance feature of a building. Budget and time allowances for Roof Gardens vary dependent on design, e.g., growth media and plant selection. As with any biological system, Carlisle Roof Gardens require proper care and maintenance to thrive and perform as designed.

This attachment outlines Carlisle’s requirements for maintenance on Roof Garden systems in American Horticultural Society (AHS) Plant Heat–Zones 3-8 when a Vegetation Warranty is purchased as part of a Carlisle Total Systems Warranty. Roof Garden systems installed outside of Zones 3-8 will be addressed on a case-by-case basis. Carlisle’s Vegetation Warranty will only remain valid and affective if there is a maintenance plan and/or contract in place for the duration of the warranty period. Maintenance may be accomplished by contracting a landscaping or nursery professional. However, the Owner may elect to self-perform the required maintenance assuming there are adequate and competent personnel able to understand, follow and document the requirements and guidelines set forth in this attachment. Failure to perform and document maintenance as outlined in this attachment may be grounds for termination of the Vegetation Warranty. Any claim made under Carlisle’s Vegetation Warranty is contingent upon the Owner’s proof and documentation of strict compliance with the maintenance requirements in this attachment.

Warranty and maintenance requirements of non-standard Carlisle planting options are project specific and will be addressed on case-by-case basis.

#### Immediately After Planting

1. Fully saturate the entire Roof Garden system to the point of runoff by soaking with conventional overhead sprinklers that are supplied by a ¾” hose.
2. Inspect drains for any foreign debris that may hinder their performance and clear the drains of any such debris.

#### Irrigation Requirements

1. Document all 1<sup>st</sup> Year Maintenance in TABLE 4.
2. Permanent irrigation may not be needed, dependent upon the Roof Garden design, geographic region and microclimate where the Roof Garden is to be installed, but it is strongly recommended. **However, access to water via hose bibs at the roof level is always a requirement.**
3. Recommended water pressure is 35 psi at a volume flow of 9 gpm. Duration of irrigation events should be 30-45 minutes. Actual water pressure and volume flow will determine irrigation duration during the establishment period. Once runoff is observed, the Roof Garden system is considered to be thoroughly saturated.

- Commercial overhead sprinklers such as spider stands (PICTURE 1) should be used to provide temporary overhead irrigation.



PICTURE 1: Spider Sprinkler Stand

- Irrigation should be performed early to mid-morning or late afternoon. Never irrigate during evening hours.
- Temporary overhead irrigation of Carlisle Sedum Mats or Sedum Tiles during the establishment period to follow recommendations listed in Table 1.

**TABLE 1. Frequency of temporary irrigation for Sedum Mats and Tiles\***

	Spring Install	Early Summer Install	Late Summer Install	Fall Install	Winter Install
<b>Number of Weeks after installation</b>	April-May	June-July 15 <sup>th</sup>	July 15 <sup>th</sup> -Sept 15 <sup>th</sup>	Sept 15 <sup>th</sup> -Oct	Nov-Dec
<b>Number of 30-45 minute irrigation events per week</b>					
1-2	1-2	2	1-2	1	1
3-4	1	1	1	1	1
5-6	0-1	0-1	0-1	0-1	0-1

\*Frequency and duration of irrigation events should be adjusted to account for precipitation

- Temporary overhead irrigation of Carlisle Sedum Plugs during the establishment period to follow recommendations listed in Table 2.
- Sedum Plugs are not recommended for planting during the winter months.

**TABLE 2. Frequency of temporary irrigation for Sedum Plugs\***

	Spring Install	Early Summer Install	Late Summer Install	Fall Install	Winter Install
<b>Number of Weeks after installation</b>	April-May	June-July 15 <sup>th</sup>	July 15 <sup>th</sup> -Sept 15 <sup>th</sup>	Sept 15 <sup>th</sup> -Oct	Nov-Dec
<b>Number of 30-45 minute irrigation events per week</b>					
1-2	1-2	2	1-2	1	<b>Plugs not recommended</b>
3-4	1	1	1	1	
5-6	0-1	0-1	0-1	0-1	

\*Frequency and duration of irrigation events should be adjusted to account for precipitation

- It is imperative to closely monitor your Roof Garden system for signs of stress during drought conditions. Drought is defined as prolonged periods of extreme ambient temperatures (>90° F) with no precipitation (2-3 weeks). *Sedum album* (PICTURE 2) is a great indicator plant. If it shows signs of shrinkage, die back, or red/brown discoloration, you must irrigate the system to the point of runoff. Frequency of irrigation will depend on the depth of growth media. Extensive systems (≤4") will most likely need to be supplemented twice (2X's) as much during drought conditions.



PICTURE 2. *Sedum album* 'Coral Carpet'

10. For Extensive Roof Garden systems installed in climates receiving less than 35 inches of annual rainfall, permanent irrigation will most likely be required. This decision will be heavily influenced by the Roof Garden design and microclimate conditions.
11. The decision of whether, or not, to install a permanent irrigation system is highly dependent upon the geographic region, microclimate, growth media depth, water retention layer and plant selection. All Roof Gardens will require temporary irrigation during the establishment period and during drought conditions. If the project budget allows, a permanent irrigation system can be set to easily facilitate watering during these periods through the use of timers and rain/soil moisture sensors.
  - a. If a permanent irrigation system is installed, the system must be flushed prior to the first freeze to prevent the lines from bursting.
  - b. Prior to re-commissioning the irrigation system in the spring, check the system for leaks and perform any repairs as needed. This is also the appropriate time to verify the functionality of timers and soil moisture sensors.

### **Sedum Remediation and Propagation**

It is natural for bare spots to develop in a Roof Garden because plants have evolved to compete for space and resources. Should a bare spot develop and the Owner feels that action is required; remediation of these areas can be easily facilitated by harvesting your own cuttings. Cuttings are the top growth of a sedum plant and may be harvested one month after the spring growth flush. Cuttings should not be taken from plants under stress and should never be more than 50% of the existing growth.

1. Cut 35-50% off the top of the existing sedum growth (PICTURES 3 & 4)
2. Generously broadcast the cuttings across bare spots (PICTURE 5)
3. Cuttings must remain moist, water cuttings thoroughly for one month



PICTURE 3.



PICTURE 4.



PICTURE 5.

### **1<sup>st</sup> Year Maintenance**

1. Document all 1<sup>st</sup> Year Maintenance in TABLE 4.

2. One month after planting, all weeds and non-specified plant material must be pulled from the growth media and removed from the rooftop before weeds flower and develop seed heads.
3. Carlisle does not allow the use of herbicides on its Roof Garden systems. Potential interactions between roofing membranes and herbicides, organic or nonorganic, have not been determined. The use of herbicides on a Roof Garden will void your warranty. **Weed removal and prevention is to be accomplished through hand weeding only.**
4. If the Roof Garden was planted with sedum plugs or custom plants a minimum of one weeding event should be performed every month after installation.
5. If the Roof Garden was planted with sedum mats or sedum tiles a minimum of one weeding event should be performed every two months after installation.
6. During weeding events roof drains must be inspected and cleared of any debris.
7. After the growing season and prior to the winter months, spent vegetation may be trimmed down. Cuttings and trimmings should not be removed from the roof as they will act as mulch and return nutrients to the system in preparation for the next growing season.
8. If the Roof Garden is accessed during the winter months, de-icing products must not be used in the vicinity of the vegetation. Salts or de-icing chemicals will harm the vegetation.
9. Any snow removed from pavers or walkways should be distributed evenly across the Roof Garden to prevent potentially damaging the vegetation.
10. Should it be necessary to remove snow from the Roof Garden, care will need to be exercised to ensure that the vegetation layer is not damaged or inadvertently removed.

## 2<sup>nd</sup> Year and Onward Maintenance

1. Document all 2<sup>nd</sup> Year Maintenance in TABLE 5.
2. The spring growth flush is the period during which plants wake up from their winter dormancy. The occurrence of this period varies by geographic location and seasonal weather conditions, but typically coincides with the appearance of bulbs such as Daffodils and Tulips. After the 12 month anniversary date of the Roof Garden installation, and annually thereafter, a soil test should be performed approximately 2-3 weeks prior to the spring growth flush. For example; if the Roof Garden was installed in October of 2012, the first annual soil test would need to be performed 2-3 weeks prior the spring growth flush of 2014. Small individual samples should be collected from across the Roof Garden to provide a broad spectrum of the media condition. 1-2 cup samples should be collected from 5-15 separate locations, depending on the area of the Roof Garden. These individual samples should be labeled and sealed in plastic bags or test kits. Carlisle recommends that the samples be sent to Pennsylvania State University's Agricultural Analytical Services Laboratory for the following tests:
  - a. Saturated paste pH
  - b. Salts
  - c. Nutrients
  - d. Percent Solids
  - e. Organic content

For more information on growth media testing see the link below:

<https://agsci.psu.edu/aasl/green-roof-media-testing>

Contact information and mailing address:

Agricultural Analytical Services Laboratory  
Penn State University  
University Park, PA 16802  
814.863.0841

[www.aasi.psu.edu](http://www.aasi.psu.edu)  
<http://www.aasi.psu.edu/Greenroof.html>

3. Sedums thrive in poor soils with low nutrient levels and do not require excessive fertilization. However, should the soil test indicate that the Roof Garden's growth media requires amendment; Carlisle recommends the use of granular slow release **organic** fertilizer. Fertilizer should be applied as necessary to return the growth media to original organic content. A single fertilization event should occur in the spring depending on the results of the annual soil test.
4. If the Roof Garden was planted with sedum plugs or custom plants a minimum of one weeding event should be performed every 2 months.
5. If the Roof Garden was planted with sedum mats or sedum tiles, a minimum of one weeding event should be performed every three months.
6. During weeding events roof drains must be inspected and cleared of any debris.
7. After the local trees have dropped their leaves, a final weeding event and general inspection must be performed. All debris must be removed from the Roof Garden and drains must be given a final inspection for the season.
8. If the Roof Garden is accessed during the winter months, de-icing products must not be used in the vicinity of the vegetation. Salts or de-icing chemicals will harm the vegetation.
9. Any snow removed from pavers or walkways should be distributed evenly across the Roof Garden to prevent excessive point loading on the building and potentially damaging the vegetation.
10. Should it be necessary to remove snow from the Roof Garden, care will need to be exercised to ensure that the vegetation layer is not damaged or inadvertently removed.

### **Photographic Documentation**

If a Vegetation Warranty is purchased, Carlisle requires that photographic documentation be provided for support throughout the term of the warranty, typically for a period of twenty-four (24) months. Photographs need to be of sufficient quality and resolution to accurately depict the conditions of the Roof Garden. The number of photographs will vary by project size, but the quantity submitted should cover the majority of the Roof Garden area. Failure to provide sufficient photographic documentation may be cause for termination of the Vegetation Warranty. Photographs are to be submitted to [Vegetation@CarlisleSynTec.com](mailto:Vegetation@CarlisleSynTec.com). The schedule for providing photographs is as follows:

1. Substantial completion of Roof Garden
2. 1 Month
3. 3 Months
4. 6 Months
5. 12 Months
6. 18 Months
7. 24 Months

Carlisle requests that pre-winter and spring growth flush photographs be provided.



**TABLE 4. 1<sup>st</sup> Year Maintenance**

Roof Garden Installation Date: \_\_\_\_\_

<b>Performed By</b>	<b>Date</b>	<b>Activity</b>	<b>Observations/Duration</b>
Example: ABC Green Roofing Maint. Co.	21 Aug. 2012	Supplemental Irrigation due to 15 days of >92° and no rain	Vegetation appears heat stressed. Red/brown foliage. Watered for 40 min. until fully saturated.
		Weeding Event 1	
		Roof Drains Inspected	
		Weeding Event 2	
		Roof Drains Inspected	
		Weeding Event 3	
		Roof Drains Inspected	
		Weeding Event 4	
		Roof Drains Inspected	
		Supplemental Irrigation During Drought Conditions (if required)	

\*Add rows as necessary to provide adequate documentation.

**TABLE 5. 2<sup>nd</sup> Year Maintenance**

Roof Garden Installation Date: \_\_\_\_\_

<b>Performed By</b>	<b>Date</b>	<b>Activity</b>	<b>Observations/Duration</b>
		Annual Soil Test	
		Weeding Event 1	
		Roof Drains Inspected	
		Weeding Event 2	
		Roof Drains Inspected	
		Weeding Event 3	
		Roof Drains Inspected	
		Weeding Event 4	
		Roof Drains Inspected	
		Supplemental Irrigation During Drought Conditions (if required)	

\*Add rows as necessary to provide adequate documentation.





## Traditional

### Roof Garden Roofing System

#### Installation Details

#### TABLE OF CONTENTS

July 2025

<b>Various Roof Garden Assemblies</b>	<b>Detail</b>
Shallow: 2.5" to 5" Assembly.....	RG A
Medium: 5" to 8" Assembly.....	RG B
Deep: > 8" Assembly.....	RG C
IRMA Shallow: Roof Garden Assembly.....	RG D
IRMA Medium/Deep: Roof Garden Assembly.....	RG E
Steep Sloped - Shallow: Roof Garden Assembly.....	RG F1
Steep Sloped - Shallow: Design Requirements.....	RG F2
<b>Gutter Edges</b>	
Shallow: Gutter Edge – Cross Section.....	RG 1.1A
Shallow: Gutter Edge - Isometric.....	RG 1.1B
Medium/Deep: Gutter Edge – Cross Section.....	RG 1.2A
Medium/Deep: Gutter Edge - Isometric.....	RG 1.2B
<b>Roof Drains</b>	
Shallow: Roof Drain – Ballast Stone – Cross Section.....	RG 6.1A
Shallow: Roof Drain – Ballast Stone – Isometric.....	RG 6.1B
Shallow: Roof Drain – Stained Glass Stone.....	RG 6.2
Medium/Deep: Roof Drain – Cross Section.....	RG 6.3A
Medium/Deep: Roof Drain - Isometric.....	RG 6.3B
Medium/Deep IRMA: Roof Drain – Cross Section.....	RG 6.4A
Medium/Deep IRMA: Roof Drain - Isometric.....	RG 6.4B
<b>Pipe Flashing</b>	
All Assemblies: Field Fabricated Pipe Flashing –Stone Ballast.....	RG 8.1
All Assemblies: Field Fabricated Pipe Flashing – Stained Glass Stone.....	RG 8.2
<b>Transitions</b>	
All Assemblies: Vertical Transition –Stone Ballast.....	RG 12.1
All Assemblies: Horizontal Transition –Stone Ballast.....	RG 12.2
All Assemblies: Vertical Transition –Stained Glass Stone.....	RG 12.3
All Assemblies: Horizontal Transition –Stained Glass Stone.....	RG 12.4
All Assemblies: Vertical Transition –Pavers.....	RG 12.5
All Assemblies: Horizontal Transition –Pavers.....	RG 12.6
All Assemblies: Vertical Transition –Pavers with Pedestals.....	RG 12.7
All Assemblies: Horizontal Transition –Pavers with Pedestals.....	RG 12.8
<b>Through-Wall Scupper</b>	

All Assemblies: Thru-Wall Scupper – Cross Section ..... RG 18.1A  
All Assemblies: Thru-Wall Scupper - Isometric ..... RG 18.1B

**Universal Details**

All Assemblies: Roof Garden Edge – Cross Section ..... U-1.1A  
All Assemblies: Roof Garden Edge – Isometric..... U-1.1B

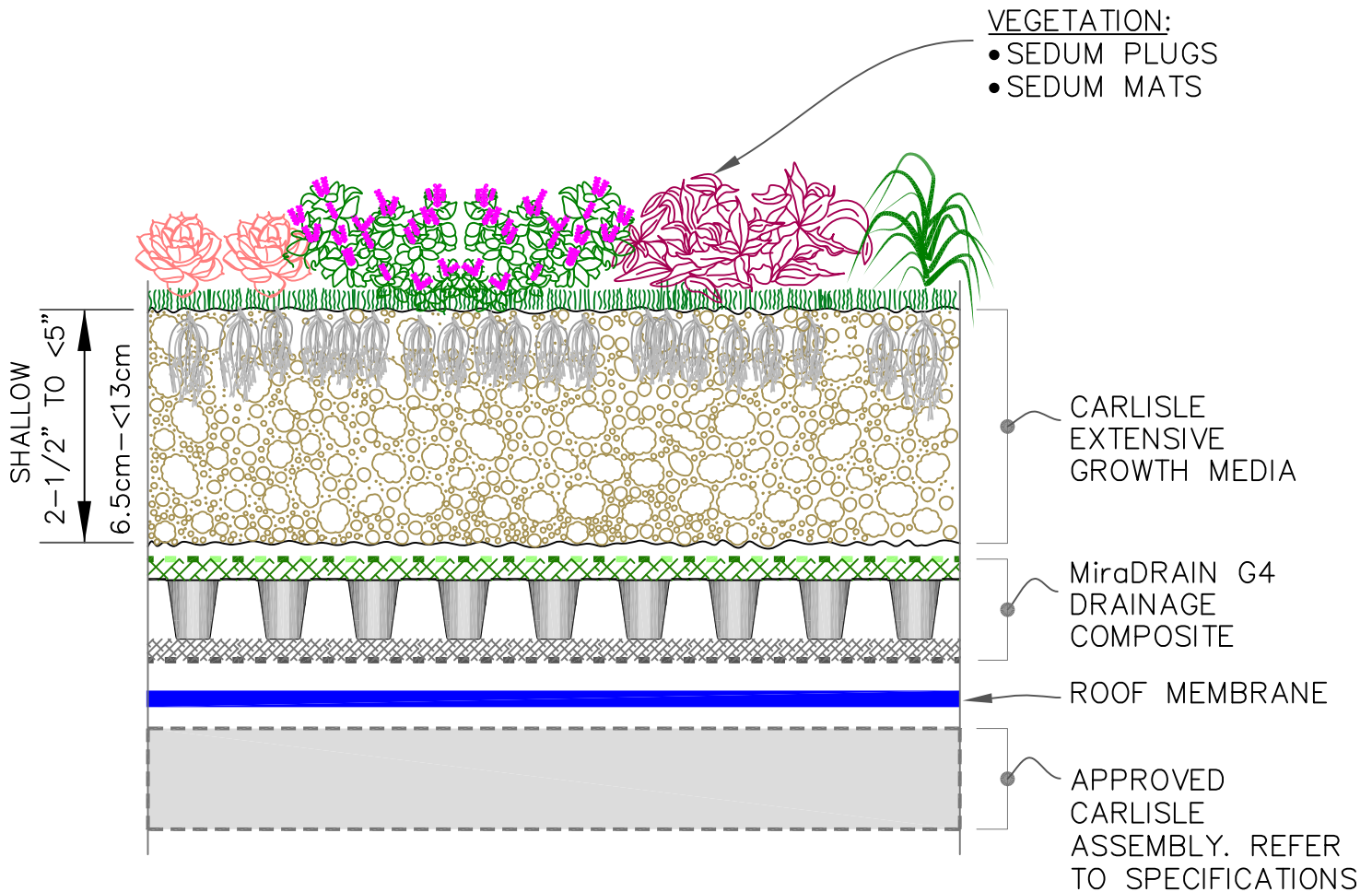

NOTES:

- A. POSITIVE SLOPE (MIN 1/4" PER 12") MUST BE PROVIDED AT MEMBRANE SURFACE LEVEL, EITHER BY SLOPING THE STRUCTURAL DECK OR BY ADDING TAPERED INSULATION BOARD ON FLAT STRUCTURAL DECK.
- B. ACCEPTABLE MEMBRANE ON CONCRETE: WHEN WATERPROOFING MEMBRANE TO BE APPLIED DIRECTLY TO STRUCTURAL OR LIGHTWEIGHT CONCRETE SUBSTRATE, FleeceBACK OR FleeceBACK AFX MEMBRANE MUST BE USED.
- C. SEAMS: REFER TO SPECIFICATIONS.

→ CARLISLE GROWTH MEDIA → MiraDRAIN G4 DRAINAGE COMPOSITE → ROOT BARRIER (40-MIL NON-REINFORCED POLYPROPYLENE) → 300HV PROTECTION FABRIC		→ ROOF MEMBRANE → POLYSTYRENE INSULATION → SEE NOTE(S) IRMA → INSULATED ROOF MEMBRANE ASSEMBLY		<b>SHALLOW (EXTENSIVE)</b> (2.5" - <5") (6.5 - <13cm) ASSEMBLY	
		ROOF GARDEN DETAILS		DETAIL NO. RGI A	

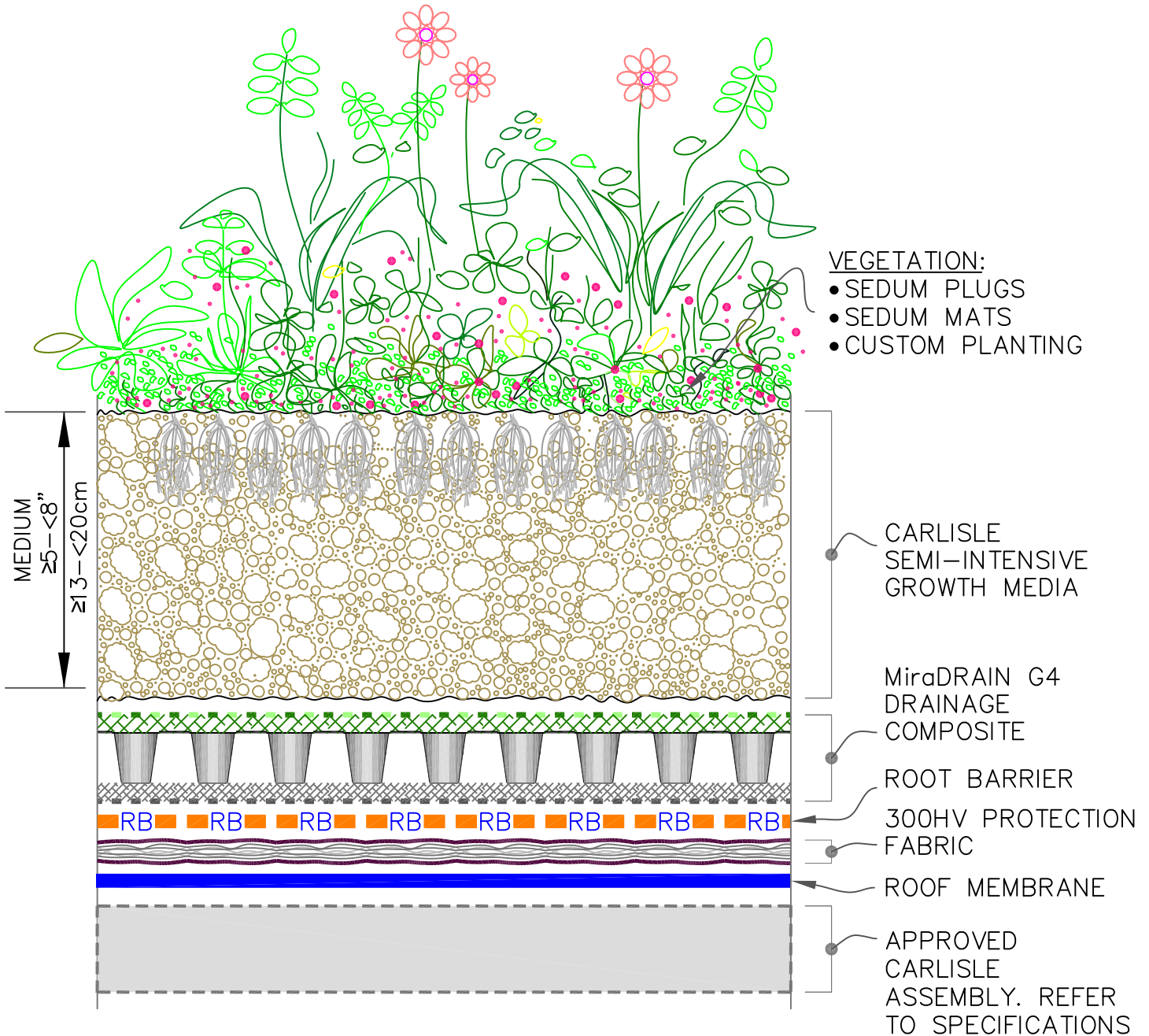

**NOTES:**

- A. POSITIVE SLOPE (MIN 1/4" PER 12") MUST BE PROVIDED AT MEMBRANE SURFACE LEVEL, EITHER BY SLOPING THE STRUCTURAL DECK OR BY ADDING TAPERED INSULATION BOARD ON FLAT STRUCTURAL DECK.
- B. ACCEPTABLE MEMBRANE ON CONCRETE: WHEN WATERPROOFING MEMBRANE TO BE APPLIED DIRECTLY TO STRUCTURAL OR LIGHTWEIGHT CONCRETE SUBSTRATE, FleeceBACK OR FleeceBACK AFX MEMBRANE MUST BE USED.
- C. SEAMS: REFER TO SPECIFICATIONS.

<p>→ CARLISLE GROWTH MEDIA</p>		<p>→ ROOT BARRIER (40-MIL NON-REINFORCED POLYPROPYLENE)</p>	
<p>→ MiraDRAIN G4 DRAINAGE COMPOSITE</p>		<p>→ POLYSTYRENE INSULATION</p>	
<p>→ 300HV PROTECTION FABRIC</p>		<p>→ SEE NOTE(S)</p>	
<p>→ IRMA → INSULATED ROOF MEMBRANE ASSEMBLY</p>		<p>→ ROOF MEMBRANE</p>	

<b>MEDIUM (SEMI-INTENSIVE)</b>	
(≥5" - <8") (≥13 - <20cm) ASSEMBLY	
ROOF GARDEN DETAILS	DETAIL NO. <b>RGI B</b>

CARLISLE ROOF GARDEN ASSEMBLY EPDM/TPO/PVC

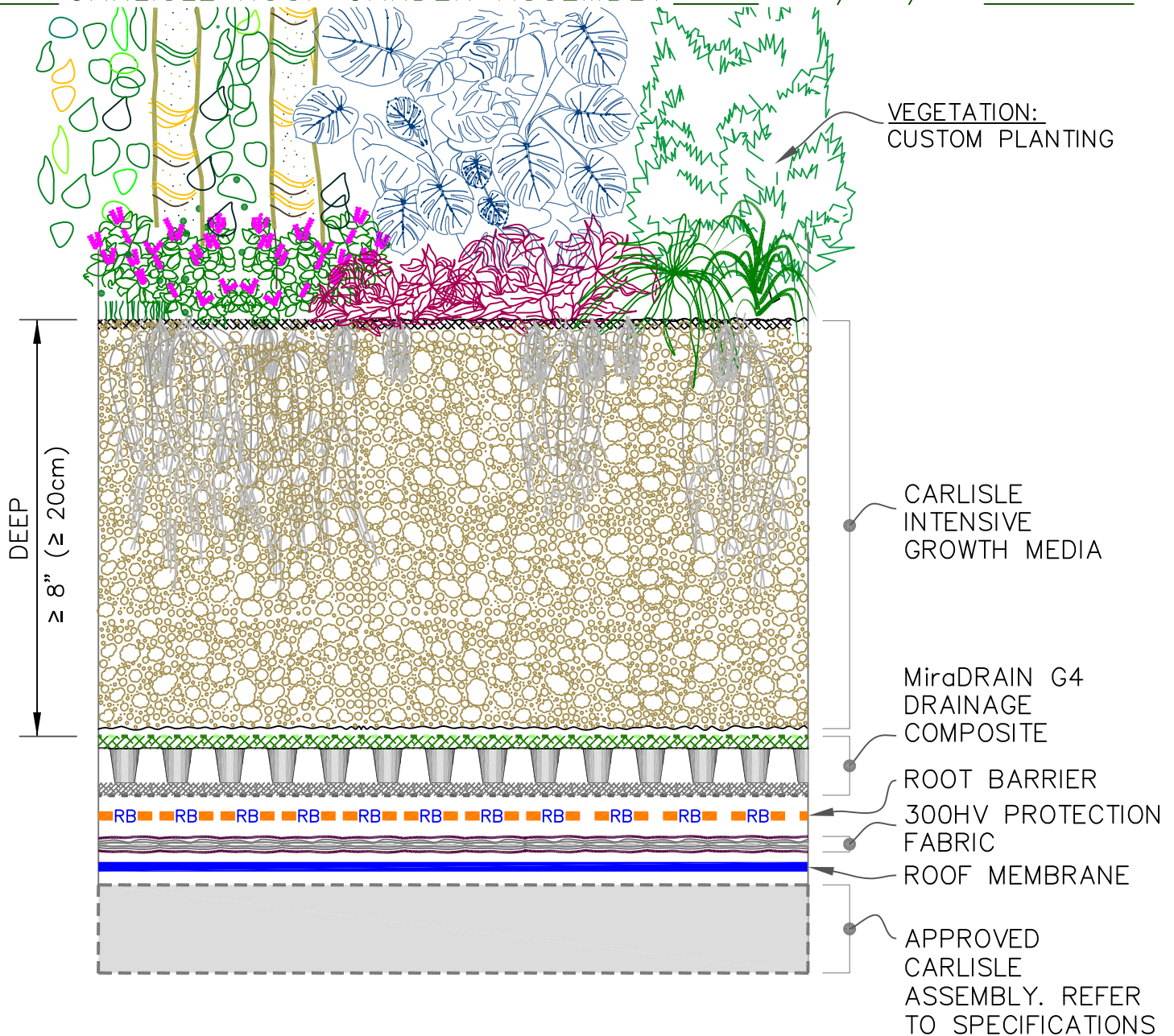

NOTES:

- A. POSITIVE SLOPE (MIN 1/4" PER 12") MUST BE PROVIDED AT MEMBRANE SURFACE LEVEL, EITHER BY SLOPING THE STRUCTURAL DECK OR BY ADDING TAPERED INSULATION BOARD ON FLAT STRUCTURAL DECK.
- B. ACCEPTABLE MEMBRANE ON CONCRETE: WHEN WATERPROOFING MEMBRANE TO BE APPLIED DIRECTLY TO STRUCTURAL OR LIGHTWEIGHT CONCRETE SUBSTRATE, FleeceBACK OR FleeceBACK AFX MEMBRANE MUST BE USED.
- C. SEAMS: REFER TO SPECIFICATIONS.

→ CARLISLE GROWTH MEDIA → MiraDRAIN G4 DRAINAGE COMPOSITE → ROOT BARRIER (40-MIL NON-REINFORCED POLYPROPYLENE) → 300HV PROTECTION FABRIC		→ ROOF MEMBRANE → POLYSTYRENE INSULATION → SEE NOTE(S) IRMA → INSULATED ROOF MEMBRANE ASSEMBLY		<p style="text-align: center;">DEEP (INTENSIVE)</p> <p style="text-align: center;">(≥ 8") (≥ 20cm) ASSEMBLY</p>	
		ROOF GARDEN DETAILS		DETAIL NO. <span style="font-size: 2em; color: green;">RGI C</span>	

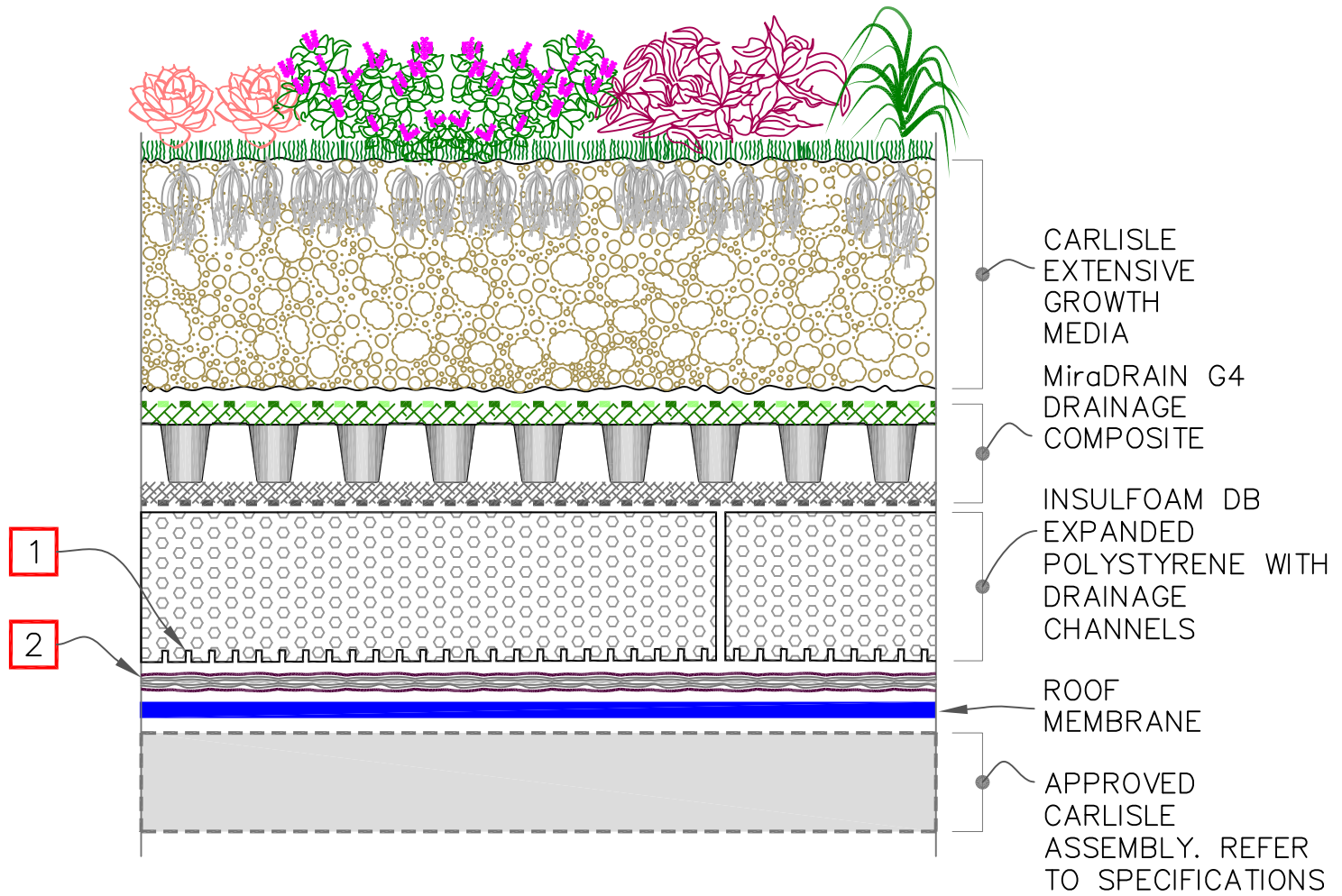

CARLISLE ROOF GARDEN  
EDGE PER RG U-1.1A,  
RG U-1.1B & SPECS.

NOTE:

1. DRAINAGE CHANNELS TO BE ORIENTED IN THE DIRECTION OF ROOF DRAINS
2. IF POLYSTYRENE INSULATION IS USED IN CONJUNCTION WITH PVC MEMBRANE, 300HV PROTECTION FABRIC IS NEEDED BETWEEN EPS AND PVC.

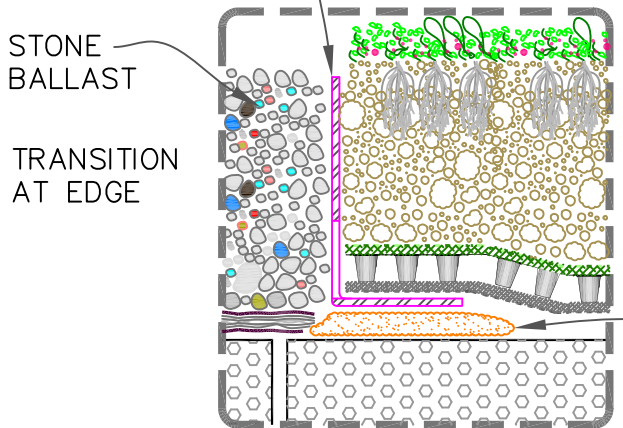

	CARLISLE GROWTH MEDIA		ROOF MEMBRANE
	MiraDRAIN G4 DRAINAGE COMPOSITE		POLYSTYRENE INSULATION
	ROOT BARRIER (40-MIL NON-REINFORCED POLYPROPYLENE)		SEE NOTE(S)
	300HV PROTECTION FABRIC	IRMA	INSULATED ROOF MEMBRANE ASSEMBLY

IRMA SHALLOW (EXTENSIVE)	
ROOF GARDEN ASSEMBLY	
2021 ROOF GARDEN DETAILS	DETAIL NO. RGI D

CAUTION  
"MEDIUM" AND "DEEP" ROOF GARDEN ASSEMBLIES REQUIRE ROOT BARRIER

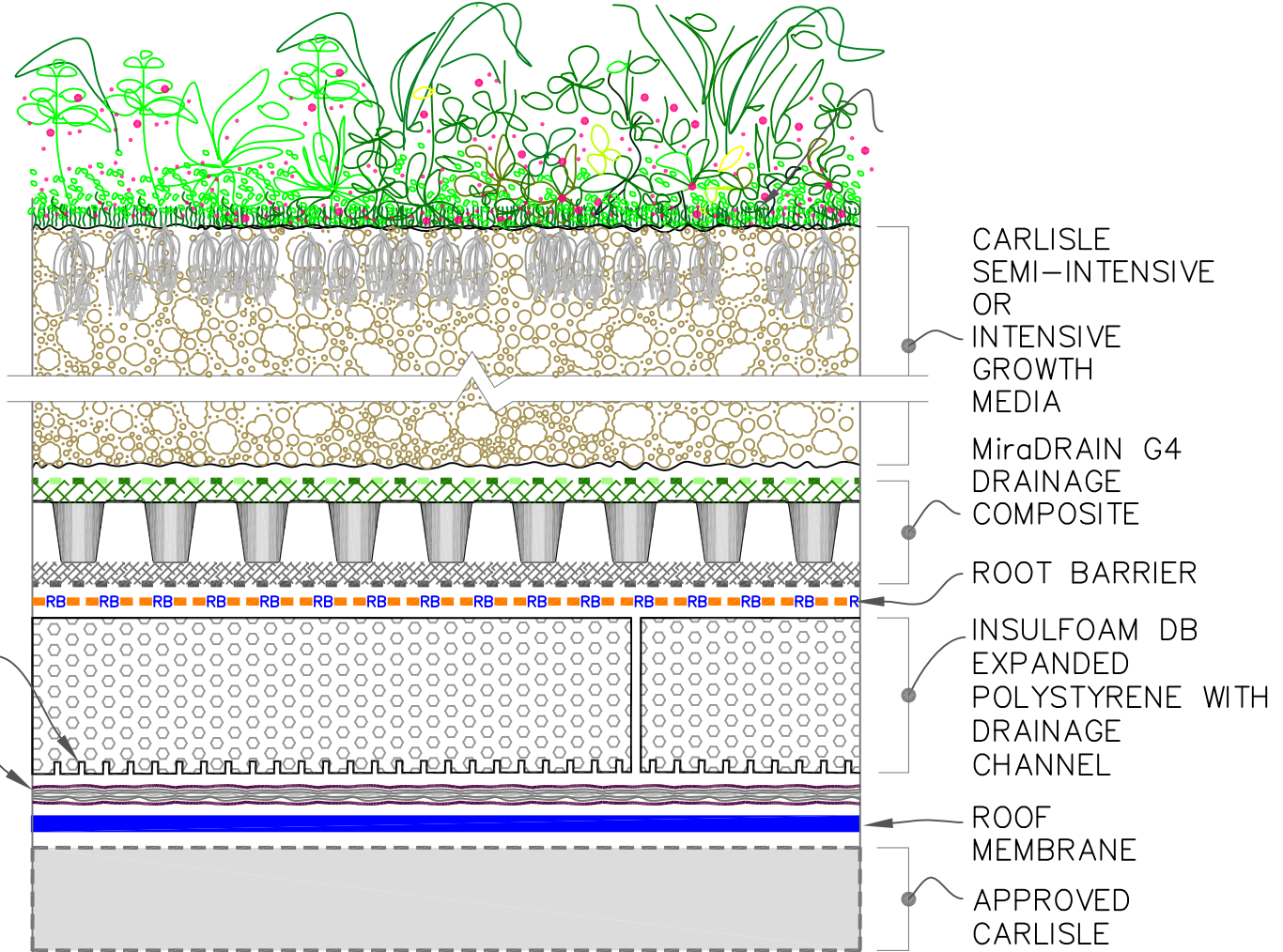

1

2

NOTE: TO SPECIFICATIONS

1. DRAINAGE CHANNELS TO BE ORIENTED IN THE DIRECTION OF ROOF DRAINS
2. IF POLYSTYRENE INSULATION IS USED IN CONJUNCTION WITH PVC MEMBRANE, 300HV PROTECTION FABRIC IS NEEDED BETWEEN EPS AND PVC.

CARLISLE ROOF GARDEN EDGE PER RG U-1.1A, RG U-1.1B & SPECS.

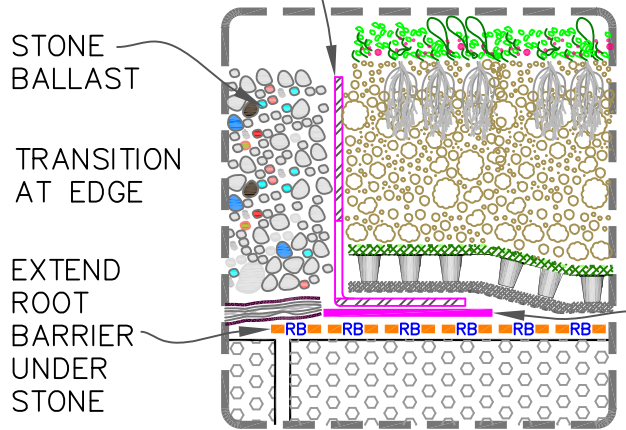

3" (7.5cm) WIDE SECURTAPE EXTENDS 1/4" (1cm) TO PROTECT ROOT BARRIER FROM METAL BURR & CORNERS.

	CARLISLE GROWTH MEDIA		ROOF MEMBRANE
	MiraDRAIN G4 DRAINAGE COMPOSITE		POLYSTYRENE INSULATION
	ROOT BARRIER (40-MIL NON-REINFORCED POLYPROPYLENE)		SEE NOTE(S)
	300HV PROTECTION FABRIC		IRMA - INSULATED ROOF MEMBRANE ASSEMBLY

IRMA MEDIUM/DEEP	
ROOF GARDEN ASSEMBLY	
2021 ROOF GARDEN DETAILS	DETAIL NO. RGI E

CARLISLE ROOF GARDEN  
EDGE PER RG U-1.1A,  
RG U-1.1B & SPECS.

ROOF  
MEMBRANE

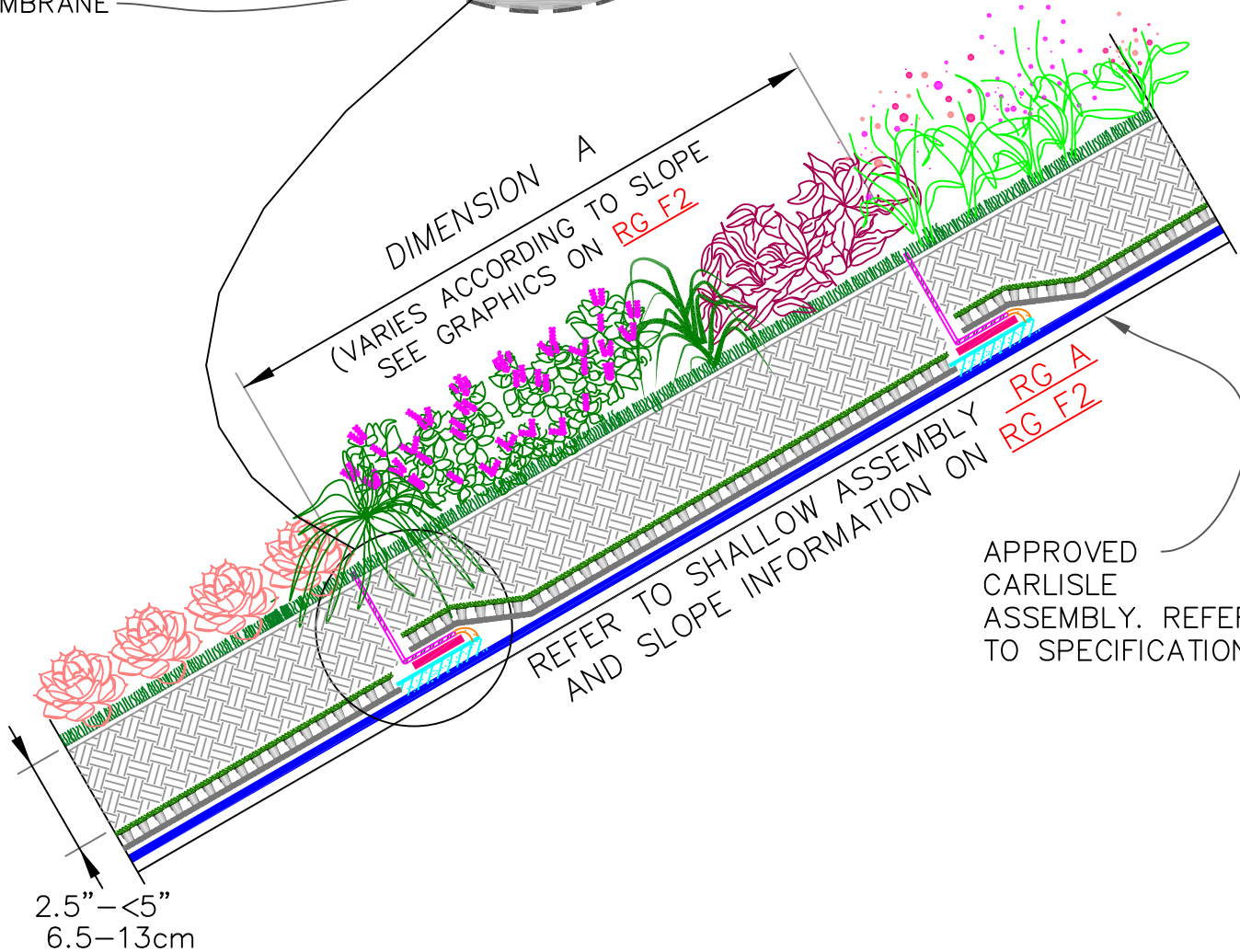
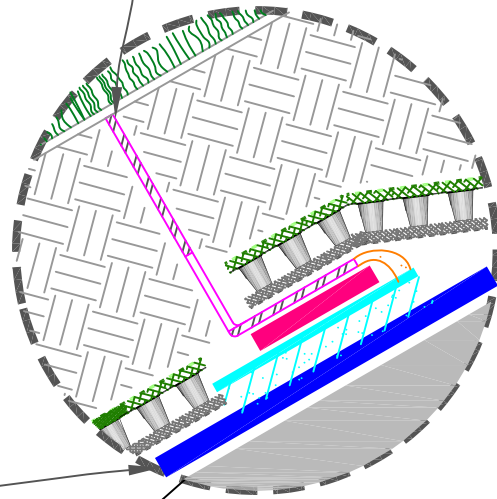

	CARLISLE GROWTH MEDIA		ROOF MEMBRANE
	MiraDRAIN G4 DRAINAGE COMPOSITE		POLYSTYRENE INSULATION
	ROOT BARRIER (40-MIL NON-REINFORCED POLYPROPYLENE)		SEE NOTE(S)
	300HV PROTECTION FABRIC		IRMA - INSULATED ROOF MEMBRANE ASSEMBLY

STEEP SLOPED - SHALLOW	
ROOF GARDEN ASSEMBLY	
ROOF GARDEN DETAILS	DETAIL NO. <b>RG1 F1</b>

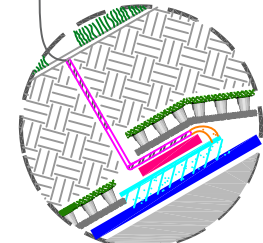
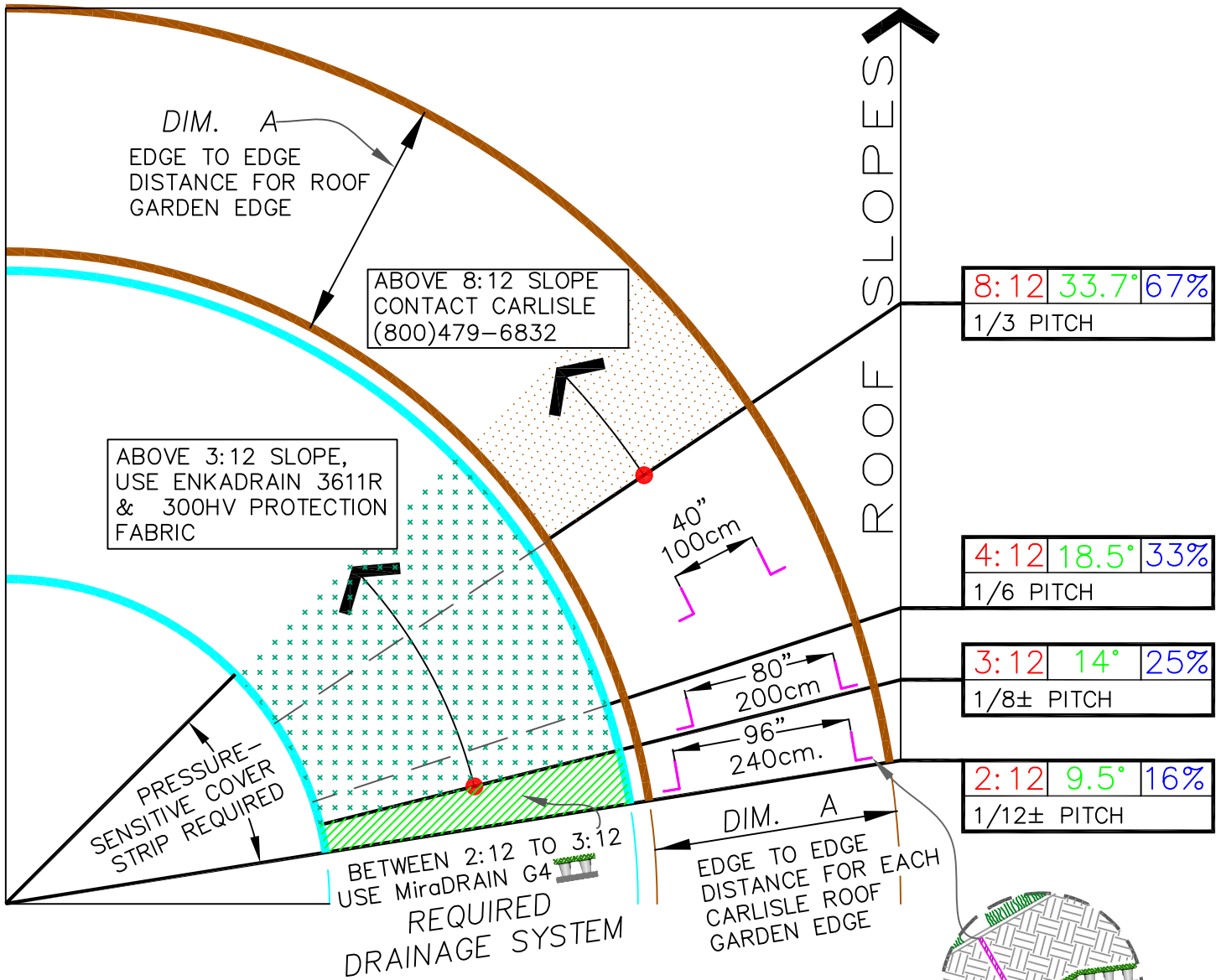

	CARLISLE GROWTH MEDIA		ROOF MEMBRANE
	MiradRAIN G4 DRAINAGE COMPOSITE		POLYSTYRENE INSULATION
	ROOT BARRIER (40-MIL NON-REINFORCED POLYPROPYLENE)		SEE NOTE(S)
	300HV PROTECTION FABRIC		IRMA - INSULATED ROOF MEMBRANE ASSEMBLY

<b>STEEP SLOPED - SHALLOW</b>	
DESIGN REQUIREMENTS	
ROOF GARDEN DETAILS	DETAIL NO.
	<b>RGI F2</b>

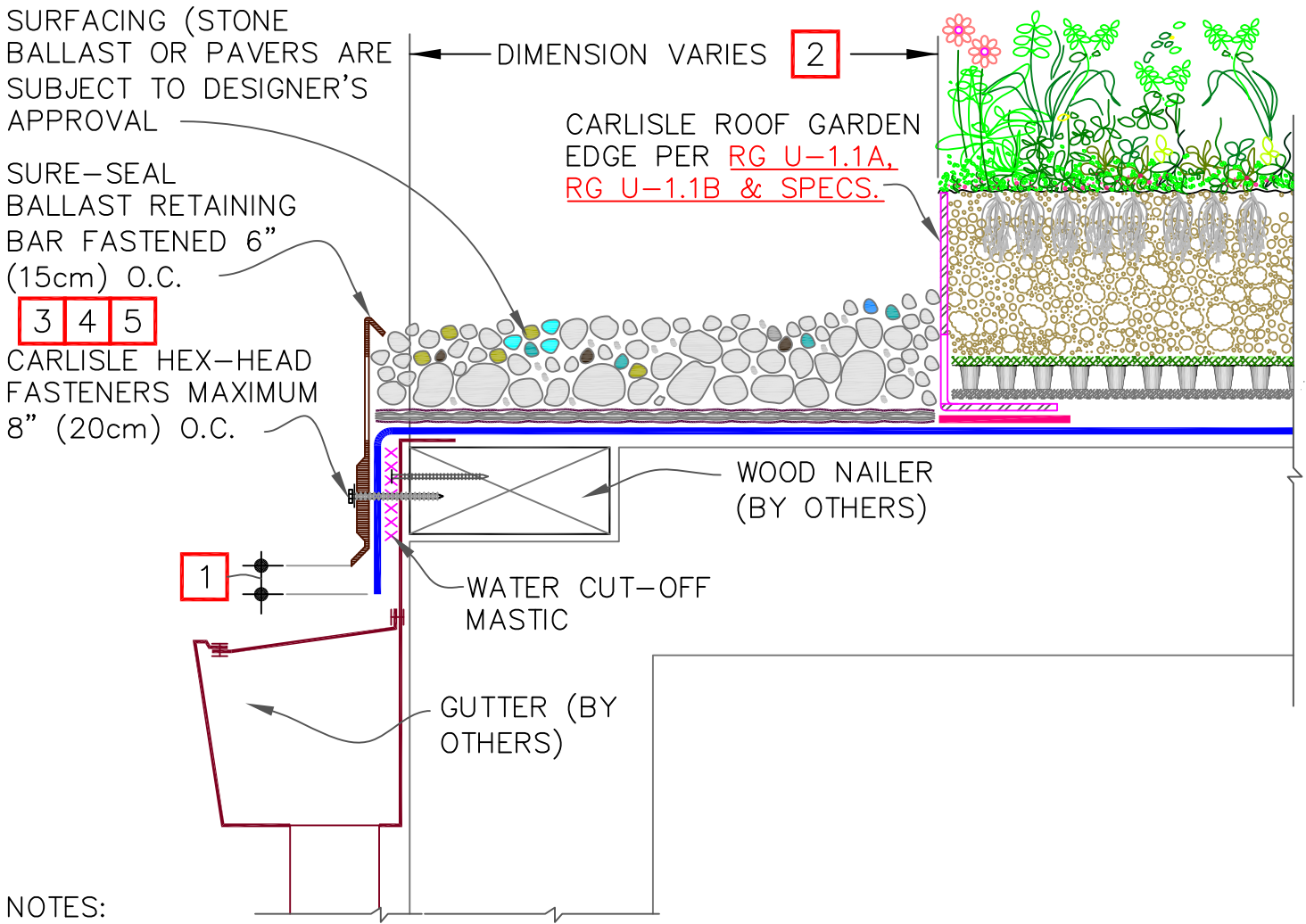

NOTES:





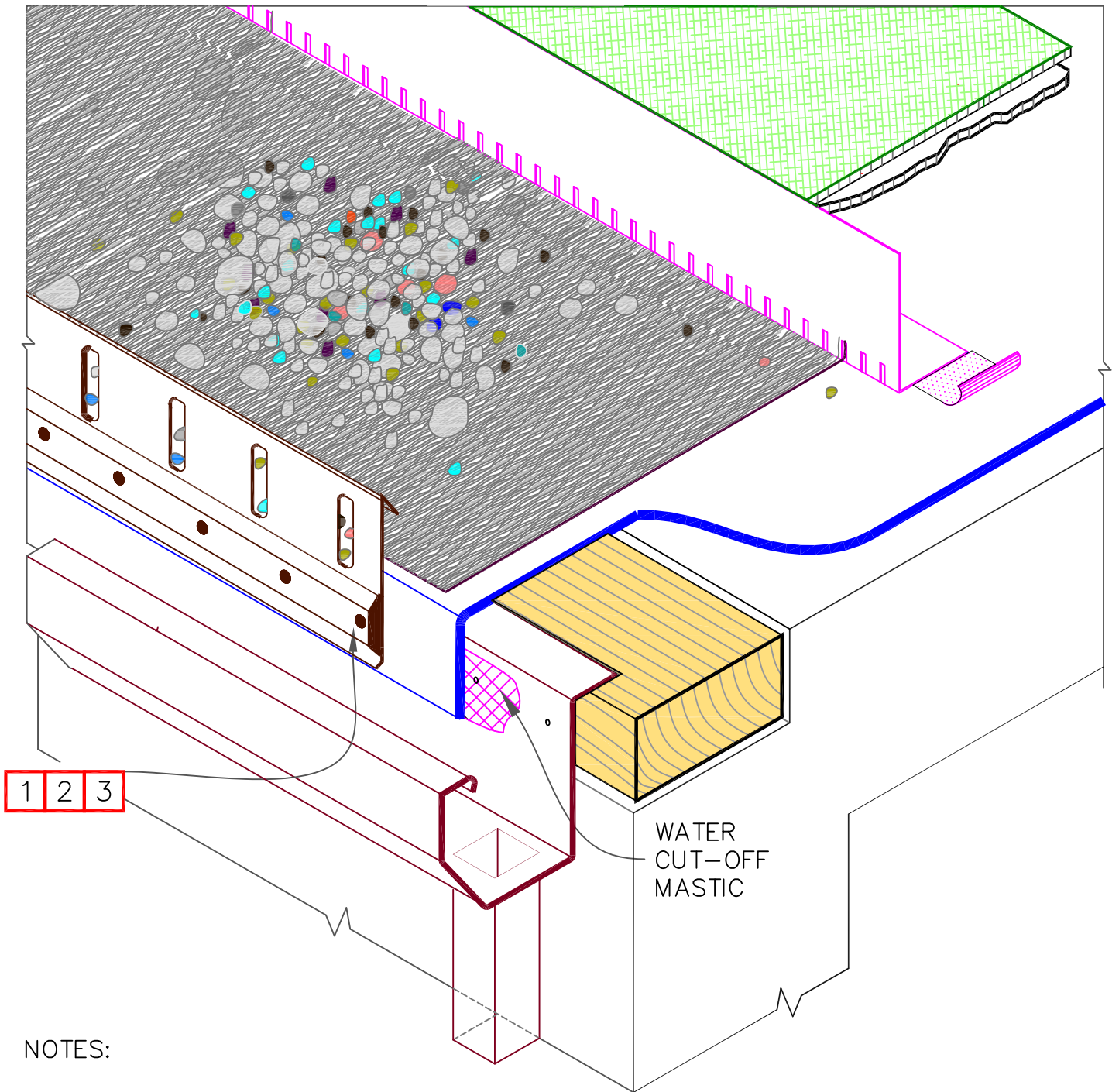

- MEMBRANE SHEET TO EXTEND 1/2" (1.5cm) MINIMUM BELOW THE METAL TERMINATION BAR.
- COMPLY WITH [ANSI/SPRI RP-14 WIND DESIGN STANDARD FOR VEGETATIVE ROOFING SYSTEMS, WWW.GREENROOFS.ORG](http://www.greenroofs.org), OR REFER TO CARLISLE ROOF GARDEN SPECIFICATIONS FOR RECOMMENDATIONS.
- BALLAST RETAINING BAR MUST PROVIDE CONSTANT COMPRESSION ON WATER CUT-OFF MASTIC.
- BALLAST RETAINING BAR MUST EXTEND ABOVE GRAVEL SURFACE SUFFICIENTLY TO RETAIN GRAVEL AND PREVENT GRAVEL MIGRATION.
- SLOTS IN BALLAST RETAINING BAR MUST BE FLUSH OR BELOW MEMBRANE LEVEL

		SHALLOW	
		GUTTER EDGE – CROSS SECTION	
		ROOF GARDEN DETAILS	DETAIL NO. <b>RGI 1.1A</b>



NOTES:

1. BALLAST RETAINING BAR MUST PROVIDE CONSTANT COMPRESSION ON WATER CUT-OFF MASTIC.
2. BALLAST RETAINING BAR MUST EXTEND ABOVE GRAVEL SURFACE SUFFICIENTLY TO RETAIN GRAVEL AND PREVENT GRAVEL MIGRATION.
3. SLOTS IN BALLAST RETAINING BAR MUST BE FLUSH OR BELOW MEMBRANE LEVEL

 → CARLISLE GROWTH MEDIA  → MiraDRAIN G4 DRAINAGE COMPOSITE  → ROOT BARRIER (40-MIL NON-REINFORCED POLYPROPYLENE)  → 300HV PROTECTION FABRIC		 → ROOF MEMBRANE  → POLYSTYRENE INSULATION  → SEE NOTE(S) IRMA → INSULATED ROOF MEMBRANE ASSEMBLY		SHALLOW	
GUTTER EDGE – ISOMETRIC				DETAIL NO.	
ROOF GARDEN DETAILS				RGI 1.1B	

SURFACING (STONE BALLAST OR PAVERS ARE SUBJECT TO DESIGNER'S APPROVAL

CARLISLE ROOF GARDEN EDGE PER [RG U-1.1A](#), [RG U-1.1B](#) & [SPECS.](#)

SURE-SEAL BALLAST RETAINING BAR FASTENED 6" (15cm) O.C.

CARLISLE HEX-HEAD FASTENERS MAXIMUM 8" (20cm) O.C.

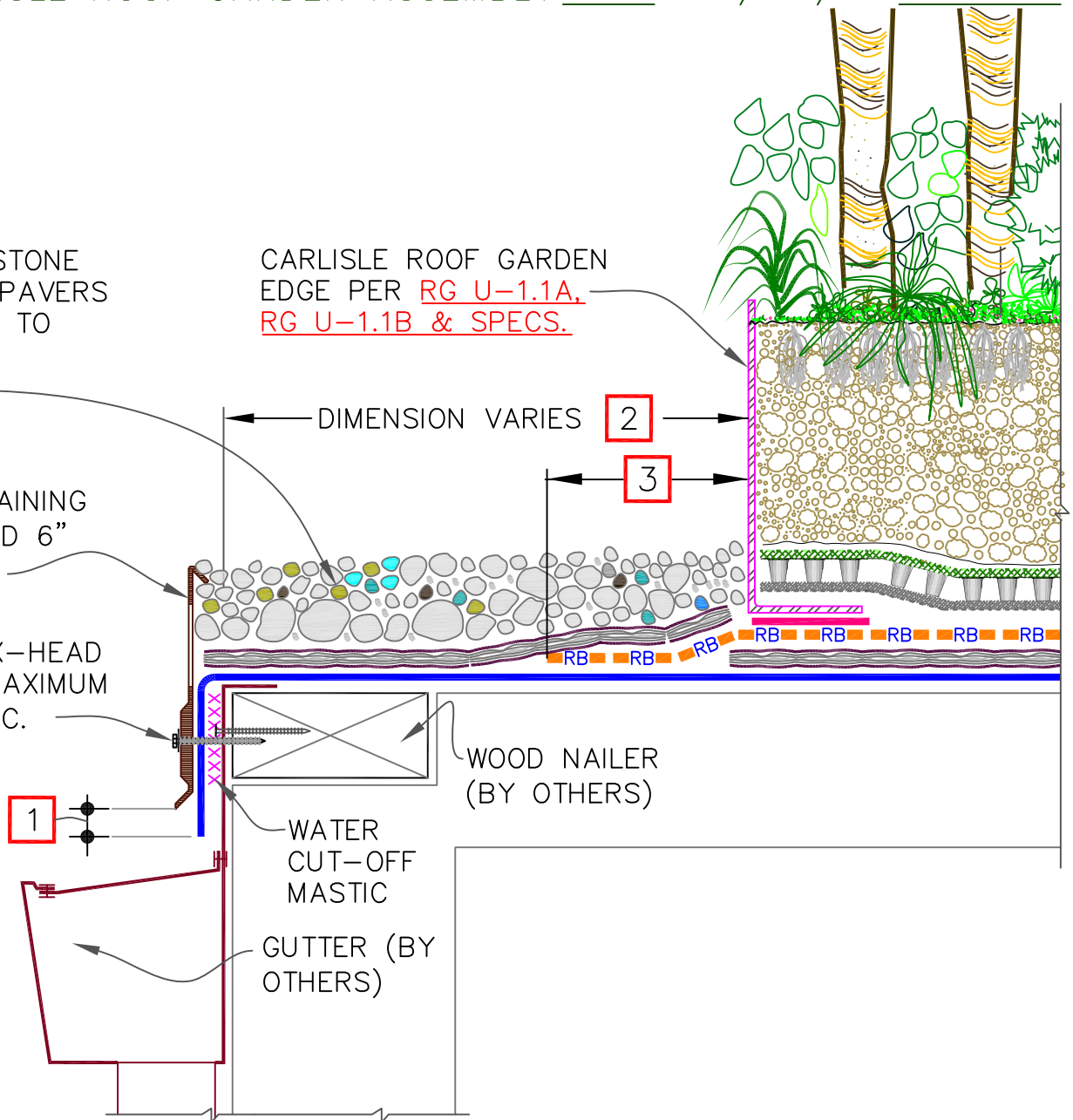







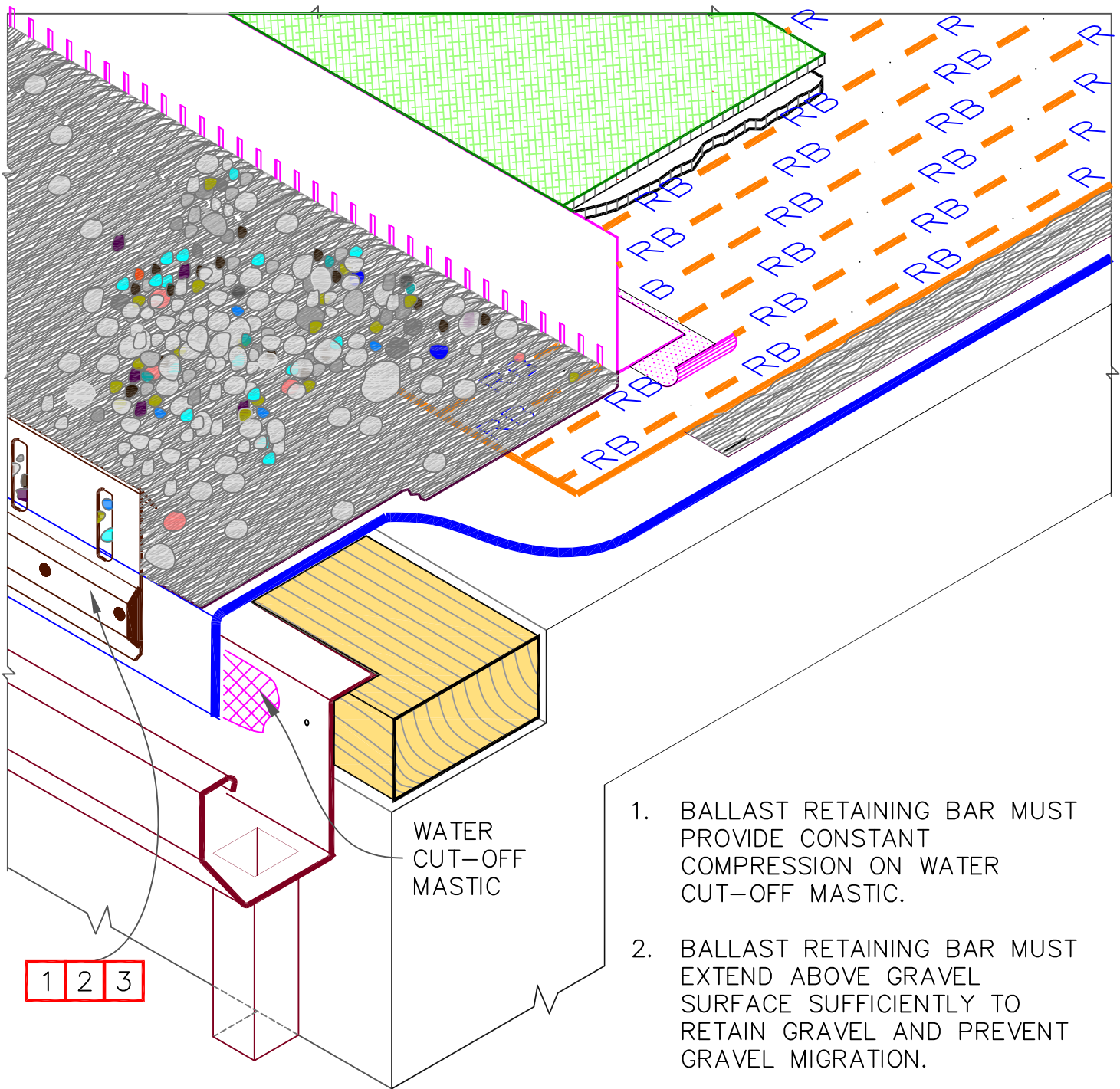

NOTES:

- MEMBRANE SHEET TO EXTEND 1/2" (1.5cm) MINIMUM BELOW THE METAL TERMINATION BAR.
- COMPLY WITH [ANSI/SPRI RP-14 WIND DESIGN STANDARD FOR VEGETATIVE ROOFING SYSTEMS](#) [WWW.GREENROOFS.ORG](http://WWW.GREENROOFS.ORG) OR REFER TO CARLISLE ROOF GARDEN SPECIFICATIONS FOR RECOMMENDATIONS.
- TERMINATE ROOT BARRIER BY EXTENDING MIN 3" (7.5cm) BEYOND ROOF GARDEN EDGE.

→ CARLISLE GROWTH MEDIA → MiraDRAIN G4 DRAINAGE COMPOSITE → ROOT BARRIER (40-MIL NON-REINFORCED POLYPROPYLENE) → 300HV PROTECTION FABRIC		→ ROOF MEMBRANE → POLYSTYRENE INSULATION → SEE NOTE(S) IRMA → INSULATED ROOF MEMBRANE ASSEMBLY		<b>MEDIUM &amp; DEEP</b>	
				GUTTER EDGE – CROSS SECTION	
		ROOF GARDEN DETAILS		DETAIL NO. <b>RG1 1.2A</b>	



1. BALLAST RETAINING BAR MUST PROVIDE CONSTANT COMPRESSION ON WATER CUT-OFF MASTIC.
2. BALLAST RETAINING BAR MUST EXTEND ABOVE GRAVEL SURFACE SUFFICIENTLY TO RETAIN GRAVEL AND PREVENT GRAVEL MIGRATION.
3. SLOTS IN BALLAST RETAINING BAR MUST BE FLUSH OR BELOW MEMBRANE LEVEL

	CARLISLE GROWTH MEDIA		ROOF MEMBRANE
	MiraDRAIN G4 DRAINAGE COMPOSITE		POLYSTYRENE INSULATION
	ROOT BARRIER (40-MIL NON-REINFORCED POLYPROPYLENE)		SEE NOTE(S)
	300HV PROTECTION FABRIC		IRMA - INSULATED ROOF MEMBRANE ASSEMBLY

<b>MEDIUM &amp; DEEP</b>	
GUTTER EDGE - ISOMETRIC	
ROOF GARDEN DETAILS	DETAIL NO. <b>RG1 1.2B</b>

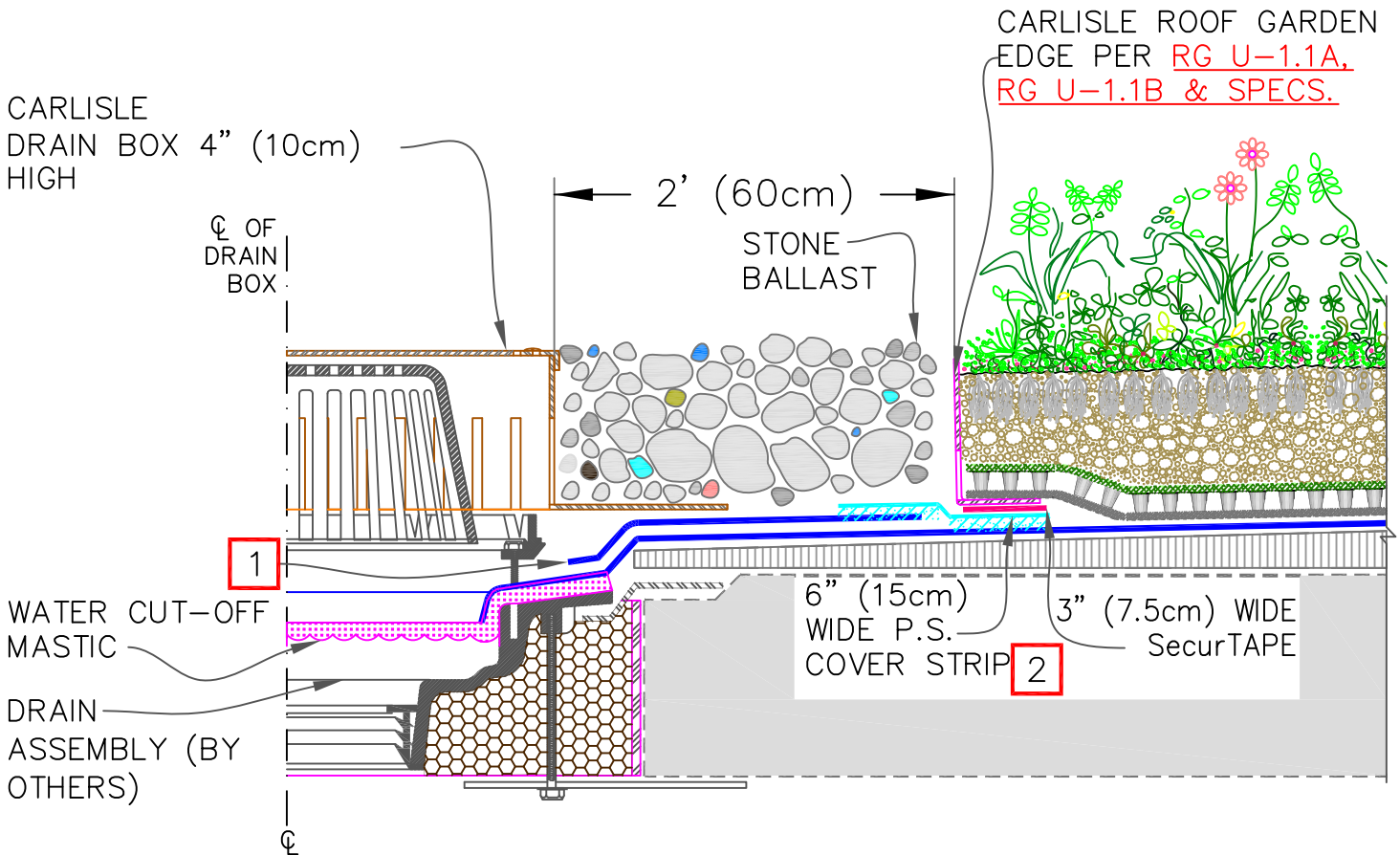







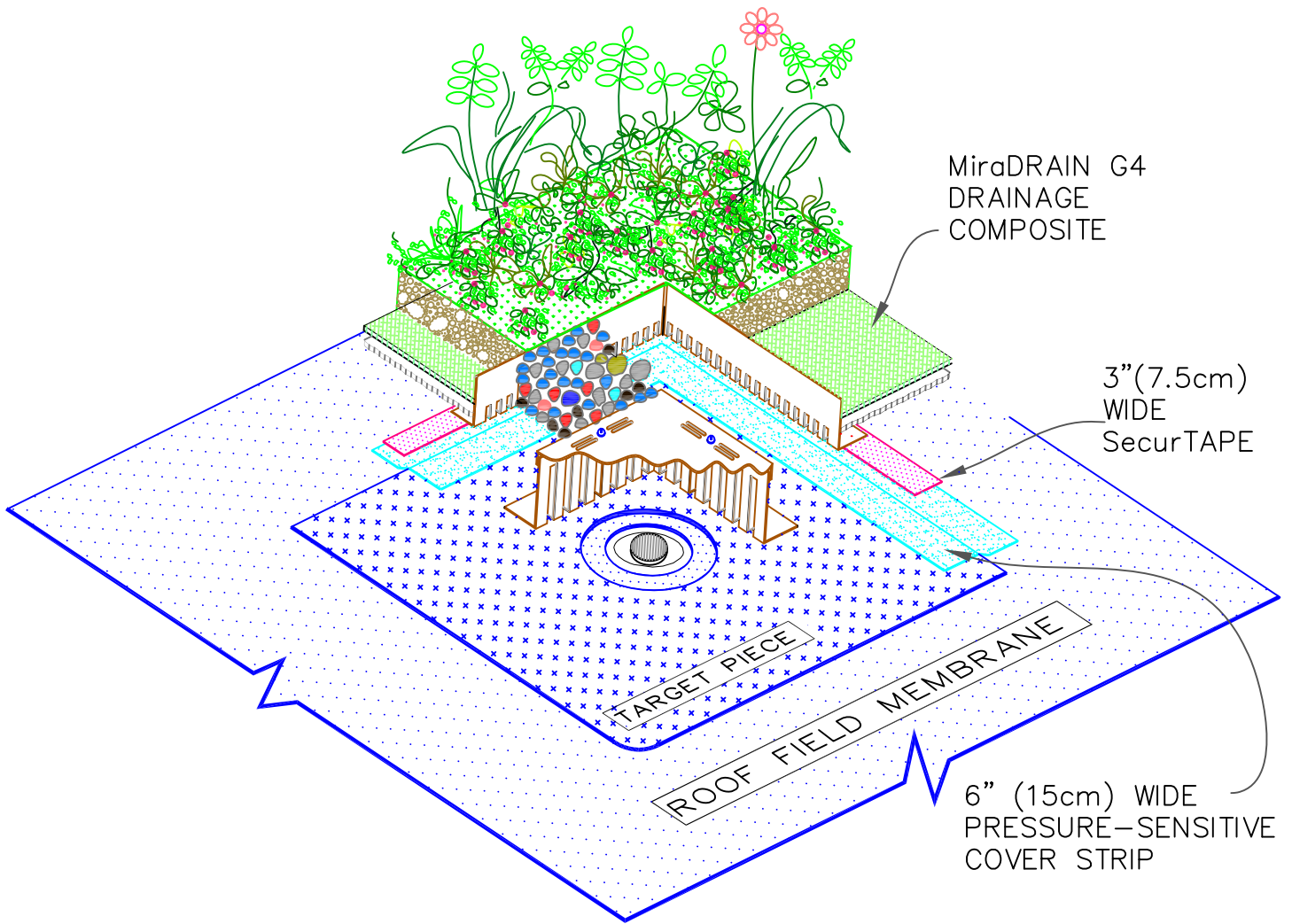

NOTES:

- MEMBRANE TARGET PIECE LOOSE-LAID, HELD DOWN WITH 6" (15cm) WIDE PRESSURE-SENSITIVE COVER STRIP AT EXTERIOR EDGES.
- WHEN PVC MEMBRANE IS USED, CARLISLE'S TWO-STEP PRIMING PROCEDURE MUST BE FOLLOWED PRIOR TO APPLYING PRESSURE-SENSITIVE ADHESIVES.

<p>CARLISLE GROWTH MEDIA</p>		<p>ROOF MEMBRANE</p>		SHALLOW	
<p>MiraDRAIN G4 DRAINAGE COMPOSITE</p>		<p>POLYSTYRENE INSULATION</p>		ROOF DRAIN – BALLAST STONE – CROSS SECTION	
<p>ROOT BARRIER (40-MIL NON-REINFORCED POLYPROPYLENE)</p>		<p>SEE NOTE(S)</p>		DETAIL NO.	
<p>300HV PROTECTION FABRIC</p>		<p>IRMA – INSULATED ROOF MEMBRANE ASSEMBLY</p>		RG1 6.1A	
				ROOF GARDEN DETAILS	



FOR MEDIUM/DEEP ASSEMBLIES, [SEE RG 6.3](#)





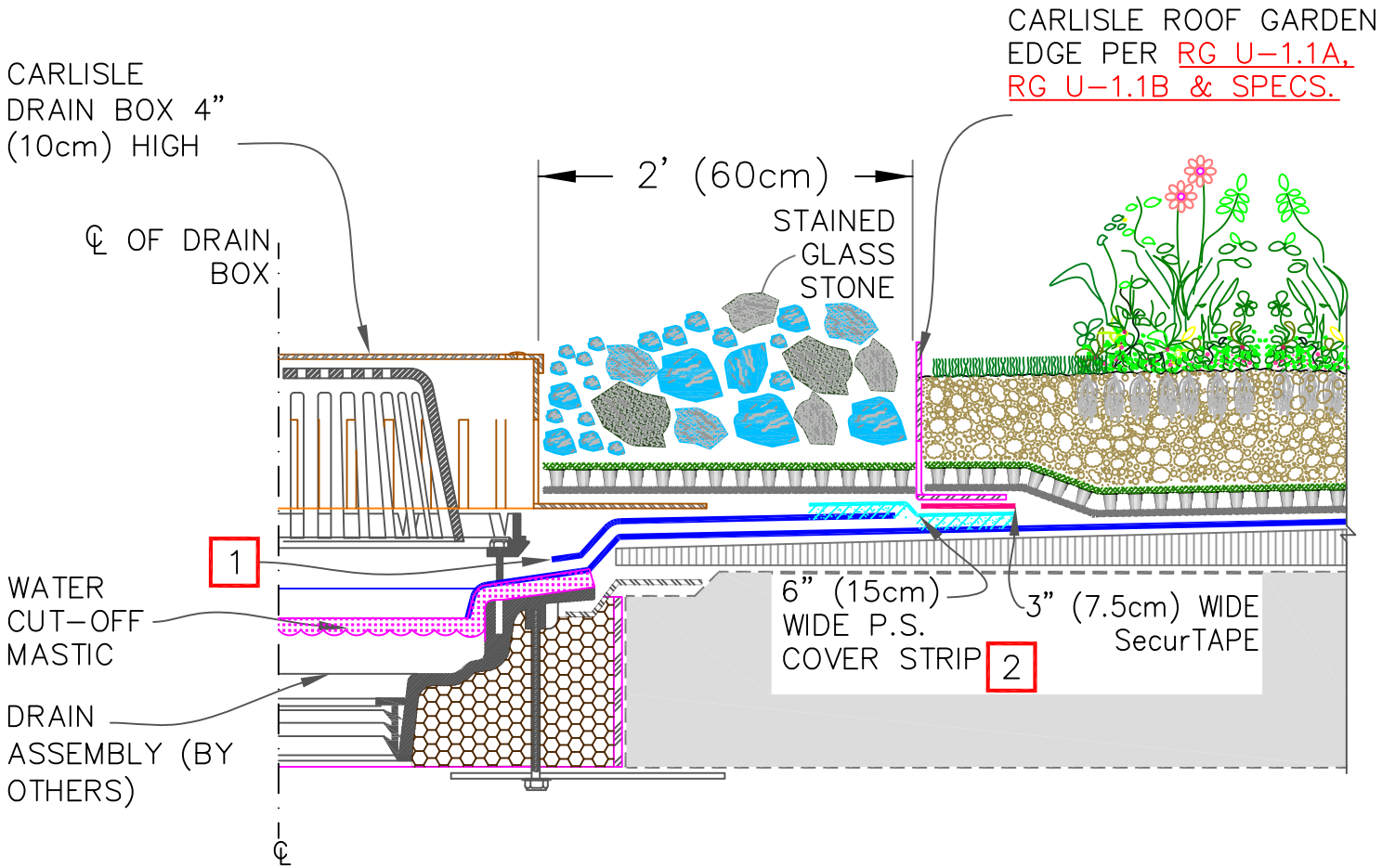



	CARLISLE GROWTH MEDIA		ROOF MEMBRANE
	MiraDRAIN G4 DRAINAGE COMPOSITE		POLYSTYRENE INSULATION
	ROOT BARRIER (40-MIL NON-REINFORCED POLYPROPYLENE)		SEE NOTE(S)
	300HV PROTECTION FABRIC		IRMA - INSULATED ROOF MEMBRANE ASSEMBLY

SHALLOW	
ROOF DRAIN - BALLAST STONE - ISOMETRIC	
ROOF GARDEN DETAILS	DETAIL NO. <b>RG1 6.1B</b>



NOTES:

- MEMBRANE TARGET PIECE LOOSE-LAID, HELD DOWN WITH 6" (15cm) WIDE PRESSURE-SENSITIVE COVER STRIP AT EXTERIOR EDGES.
- WHEN PVC MEMBRANE IS USED, CARLISLE'S TWO-STEP PRIMING PROCEDURE MUST BE FOLLOWED PRIOR TO APPLYING PRESSURE-SENSITIVE ADHESIVES.

<ul style="list-style-type: none"> <li> CARLISLE GROWTH MEDIA</li> <li> MiradRAIN G4 DRAINAGE COMPOSITE</li> <li> ROOT BARRIER (40-MIL NON-REINFORCED POLYPROPYLENE)</li> <li> 300HV PROTECTION FABRIC</li> </ul>		<ul style="list-style-type: none"> <li> ROOF MEMBRANE</li> <li> POLYSTYRENE INSULATION</li> <li> SEE NOTE(S)</li> <li> IRMA - INSULATED ROOF MEMBRANE ASSEMBLY</li> </ul>		SHALLOW	
ROOF DRAIN - STAINED GLASS STONE				DETAIL NO.	
ROOF GARDEN DETAILS			RGI 6.2		

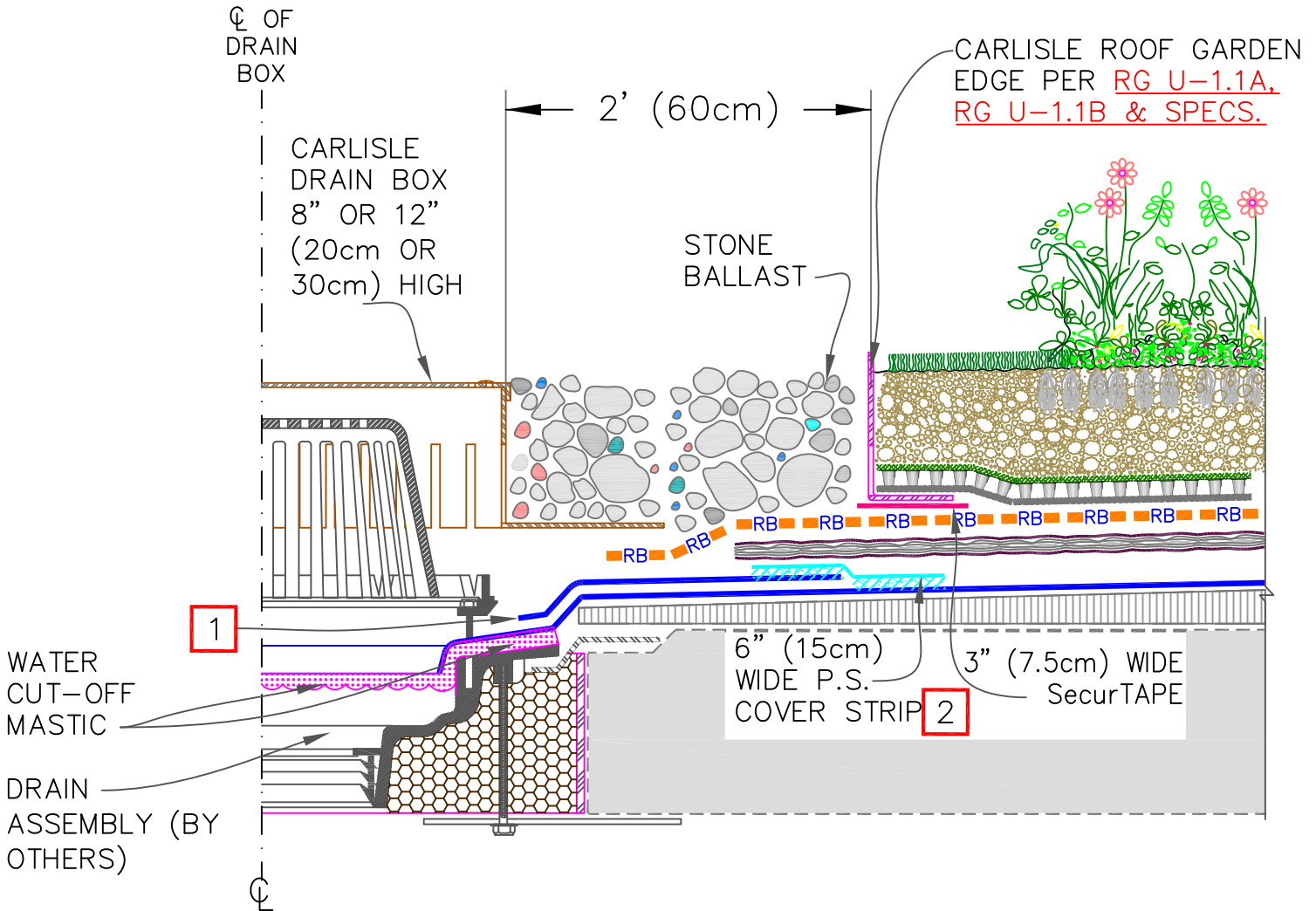

NOTES:

- MEMBRANE TARGET PIECE LOOSE-LAID, HELD DOWN WITH 6" (15cm) WIDE PRESSURE-SENSITIVE COVER STRIP AT EXTERIOR EDGES.
- WHEN PVC MEMBRANE IS USED, CARLISLE'S TWO-STEP PRIMING PROCEDURE MUST BE FOLLOWED PRIOR TO APPLYING PRESSURE-SENSITIVE ADHESIVES.

		MEDIUM / DEEP	
		ROOF DRAIN – CROSS SECTION	
		ROOF GARDEN DETAILS	DETAIL NO. <b>RG16.3A</b>

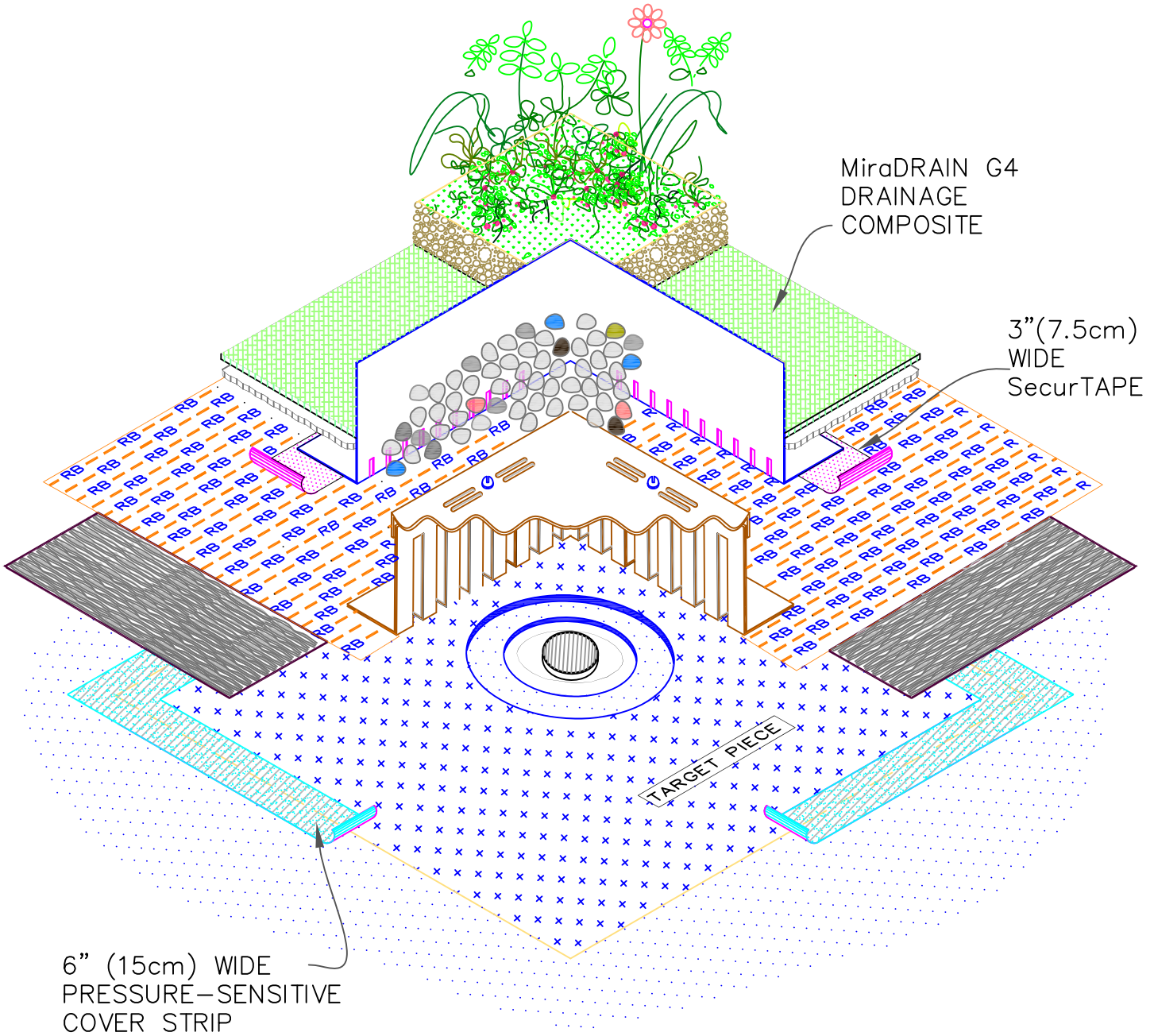









MiraDRAIN G4  
DRAINAGE  
COMPOSITE

3" (7.5cm)  
WIDE  
SecurTAPE

6" (15cm) WIDE  
PRESSURE-SENSITIVE  
COVER STRIP

TARGET PIECE

-  CARLISLE GROWTH MEDIA
-  MiraDRAIN G4 DRAINAGE COMPOSITE
-  ROOT BARRIER (40-MIL NON-REINFORCED POLYPROPYLENE)
-  300HV PROTECTION FABRIC

-  ROOF MEMBRANE
-  POLYSTYRENE INSULATION
-  SEE NOTE(S)
-  IRMA - INSULATED ROOF MEMBRANE ASSEMBLY

MEDIUM / DEEP	
ROOF DRAIN - ISOMETRIC	
ROOF GARDEN DETAILS	DETAIL NO. <b>RG1 6.3B</b>

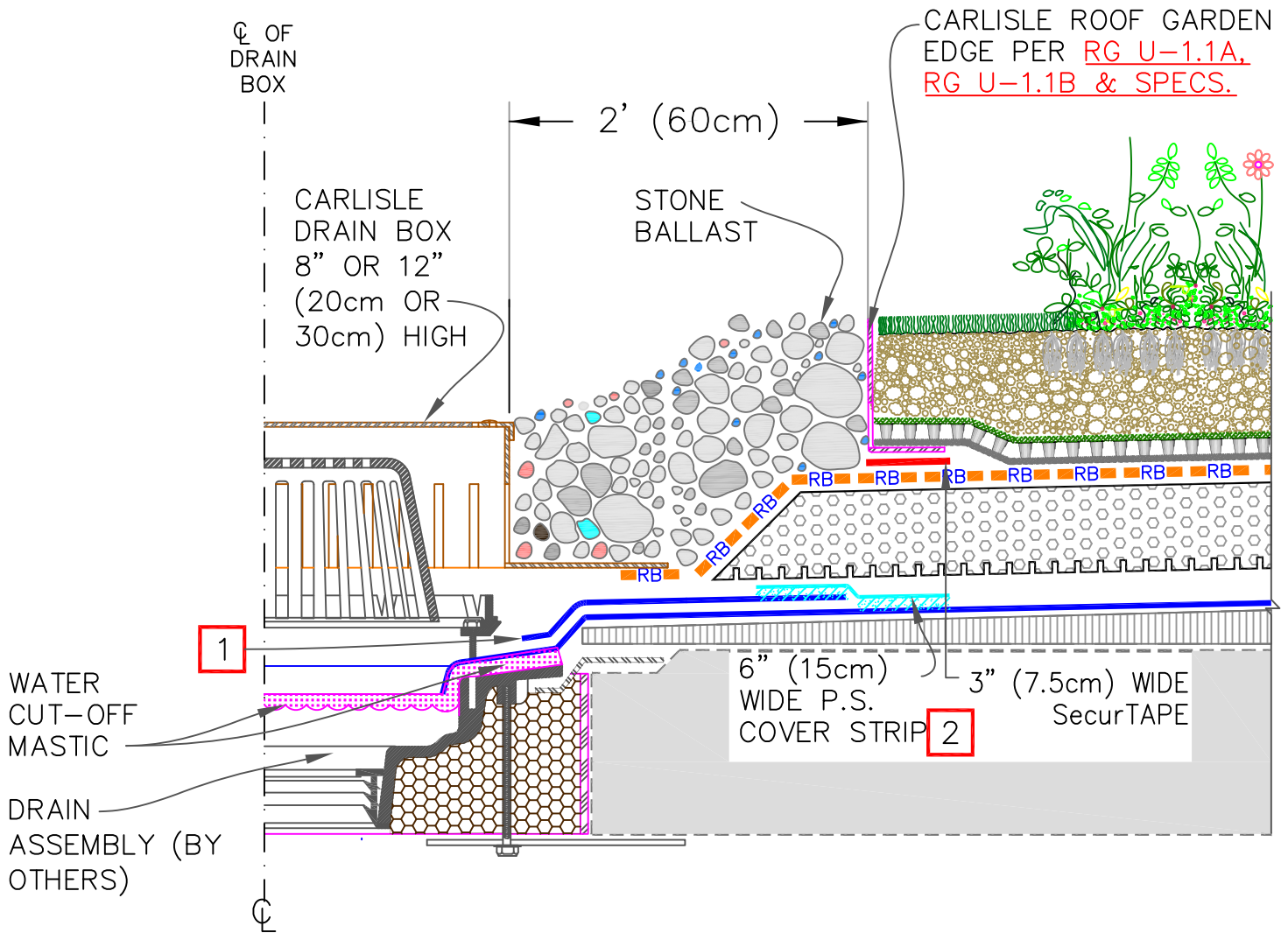







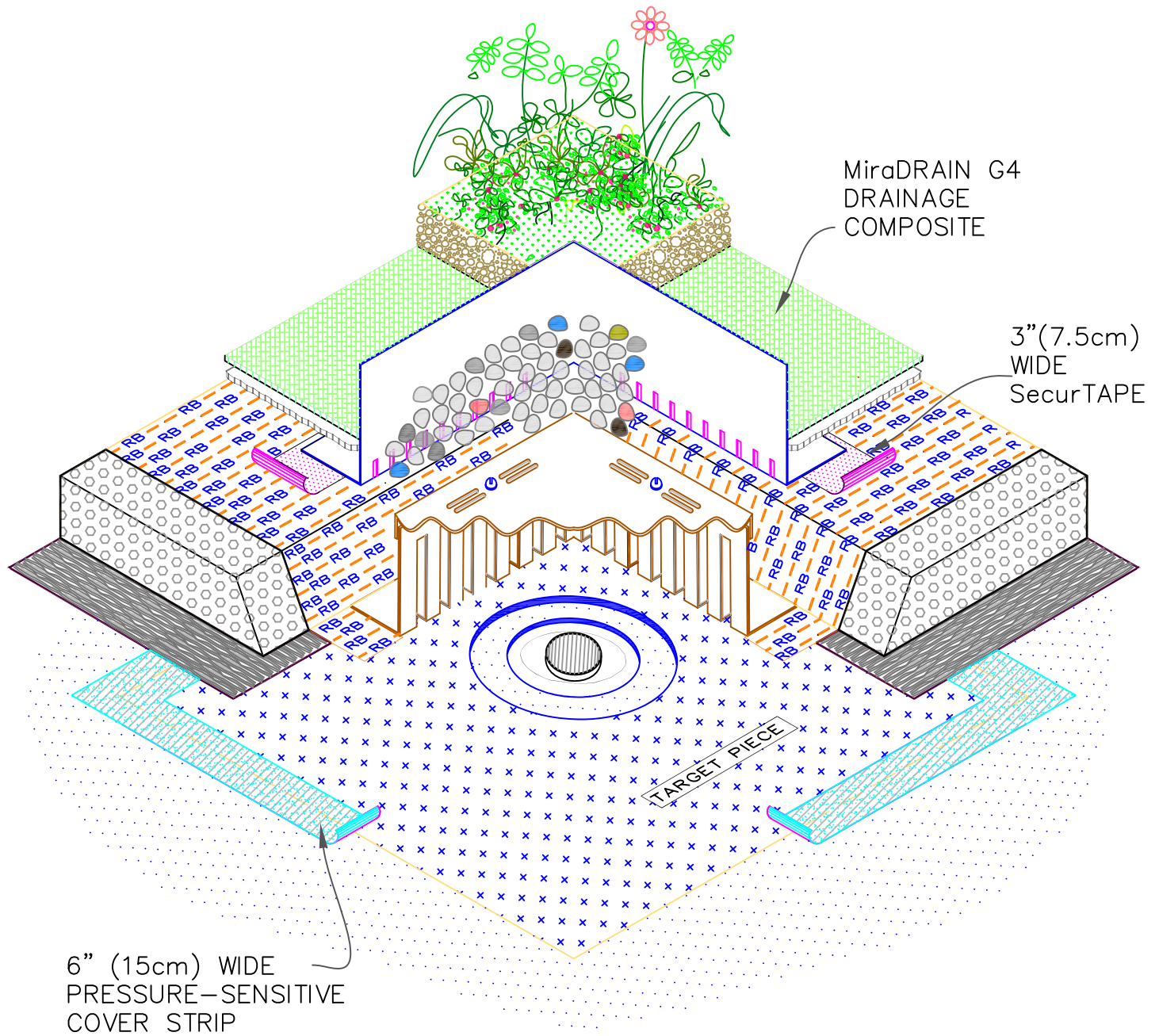

NOTES:

- MEMBRANE TARGET PIECE LOOSE-LAID, HELD DOWN WITH 6" (15cm) WIDE PRESSURE-SENSITIVE COVER STRIP AT EXTERIOR EDGES.
- WHEN PVC MEMBRANE IS USED, CARLISLE'S TWO-STEP PRIMING PROCEDURE MUST BE FOLLOWED PRIOR TO APPLYING PRESSURE-SENSITIVE ADHESIVES.

<ul style="list-style-type: none"> <li> CARLISLE GROWTH MEDIA</li> <li> MiradRAIN G4 DRAINAGE COMPOSITE</li> <li> ROOT BARRIER (40-MIL NON-REINFORCED POLYPROPYLENE)</li> <li> 300HV PROTECTION FABRIC</li> <li> ROOF MEMBRANE</li> <li> POLYSTYRENE INSULATION</li> <li> SEE NOTE(S)</li> <li> IRMA - INSULATED ROOF MEMBRANE ASSEMBLY</li> </ul>		<p>MEDIUM / DEEP - IRMA</p> <p>ROOF DRAIN - CROSS SECTION</p> <table border="1" style="width: 100%;"> <tr> <td style="width: 50%; text-align: center;">ROOF GARDEN DETAILS</td> <td style="width: 50%; text-align: center;">DETAIL NO. <b>RG16.4A</b></td> </tr> </table>		ROOF GARDEN DETAILS	DETAIL NO. <b>RG16.4A</b>
ROOF GARDEN DETAILS	DETAIL NO. <b>RG16.4A</b>				



6" (15cm) WIDE  
PRESSURE-SENSITIVE  
COVER STRIP





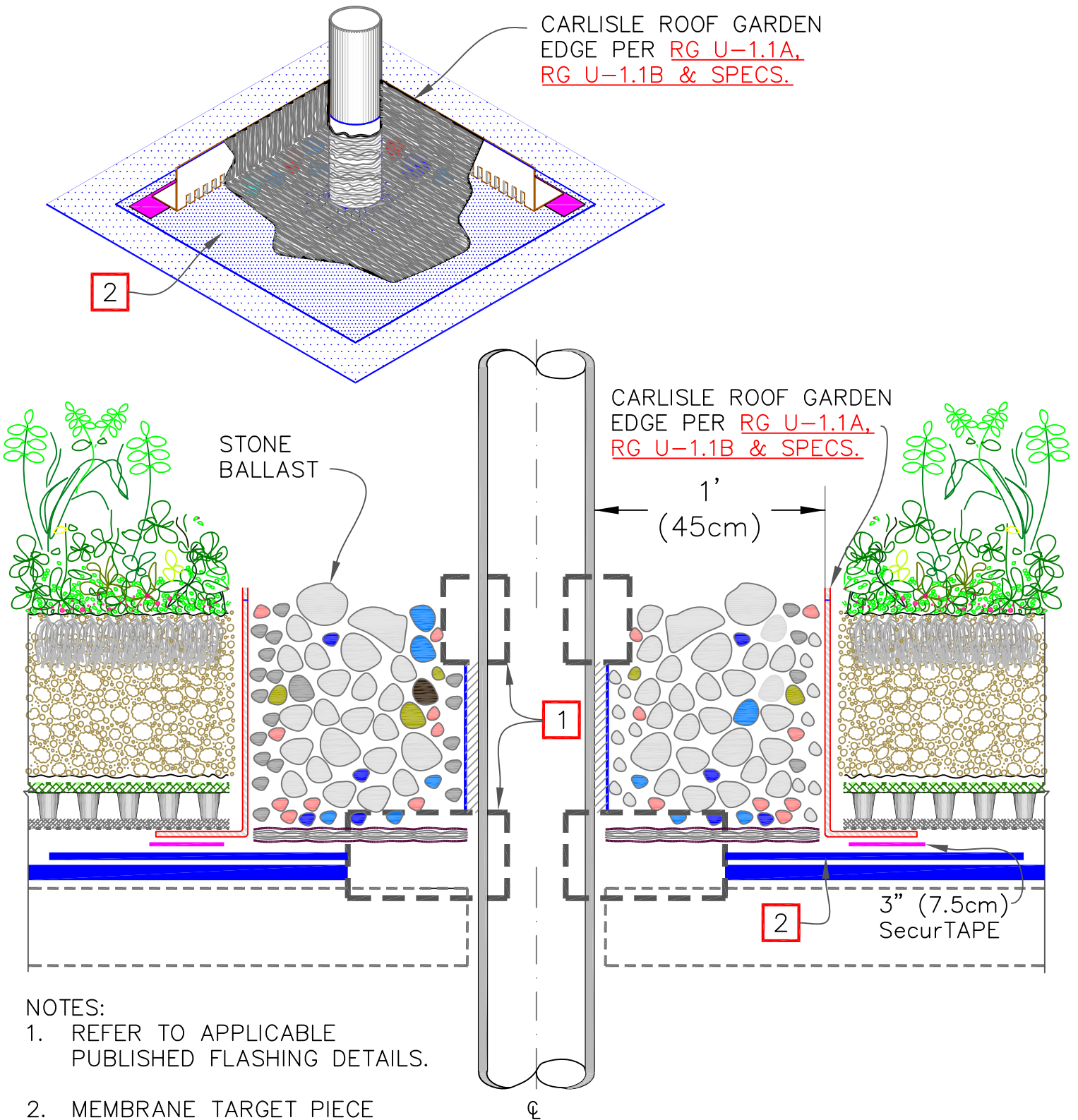



	● CARLISLE GROWTH MEDIA		● ROOF MEMBRANE
	● MiraDRAIN G4 DRAINAGE COMPOSITE		● POLYSTYRENE INSULATION
	● ROOT BARRIER (40-MIL NON-REINFORCED POLYPROPYLENE)		● SEE NOTE(S)
	● 300HV PROTECTION FABRIC		● IRMA - INSULATED ROOF MEMBRANE ASSEMBLY

MEDIUM / DEEP - IRMA	
ROOF DRAIN - ISOMETRIC	
ROOF GARDEN DETAILS	DETAIL NO.
	RGI 6.4B



NOTES:

1. REFER TO APPLICABLE PUBLISHED FLASHING DETAILS.
2. MEMBRANE TARGET PIECE LOOSE-LAID

	CARLISLE GROWTH MEDIA		ROOF MEMBRANE
	MIRADRAIN G4 DRAINAGE COMPOSITE		POLYSTYRENE INSULATION
	ROOT BARRIER (40-MIL NON-REINFORCED POLYPROPYLENE)		SEE NOTE(S)
	300HV PROTECTION FABRIC		IRMA - INSULATED ROOF MEMBRANE ASSEMBLY

ALL ASSEMBLIES	
FIELD - FABRICATED PIPE FLASHING - STONE BALLAST	
ROOF GARDEN DETAILS	DETAIL NO. RGI 8.1

CUT A SLIGHTLY  
OVERSIZED HOLE IN  
MiraDRAIN G4 AND SLIDE  
IT DOWN AT PIPE

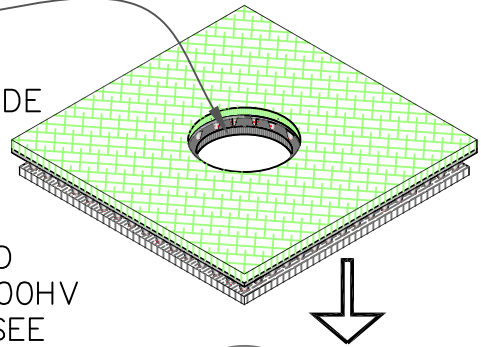

DOUBLE WRAP AROUND  
THE FLASHING WITH 300HV  
PROTECTION FABRIC. SEE  
SECTION FOR BOTTOM  
DETAIL

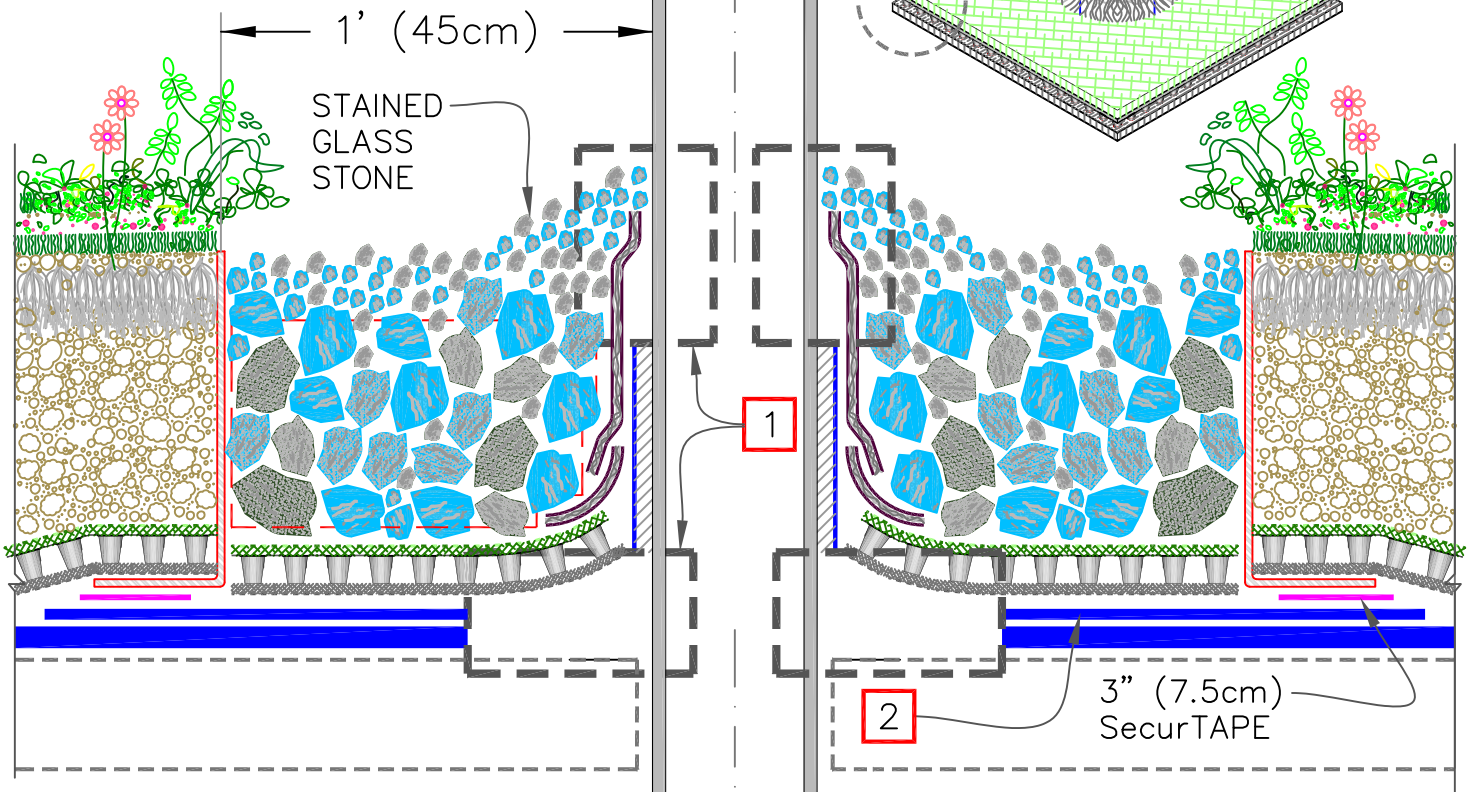
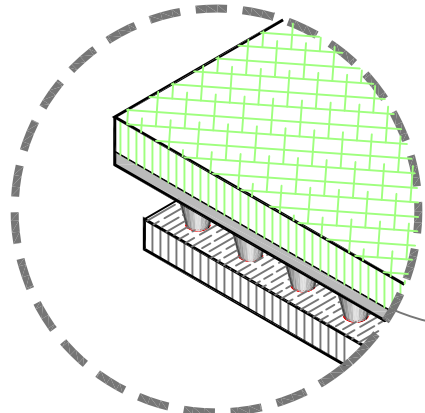
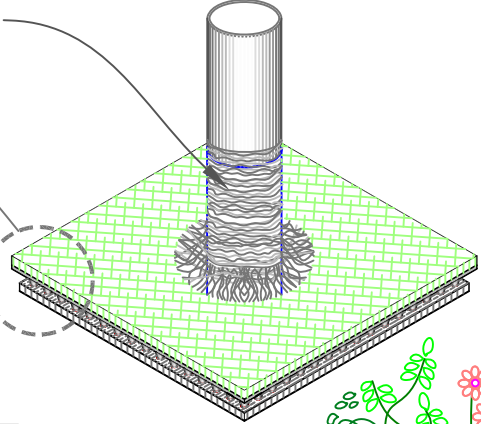

- NOTES:
- REFER TO APPLICABLE PUBLISHED FLASHING DETAILS.
  - MEMBRANE TARGET PIECE LOOSE-LAID





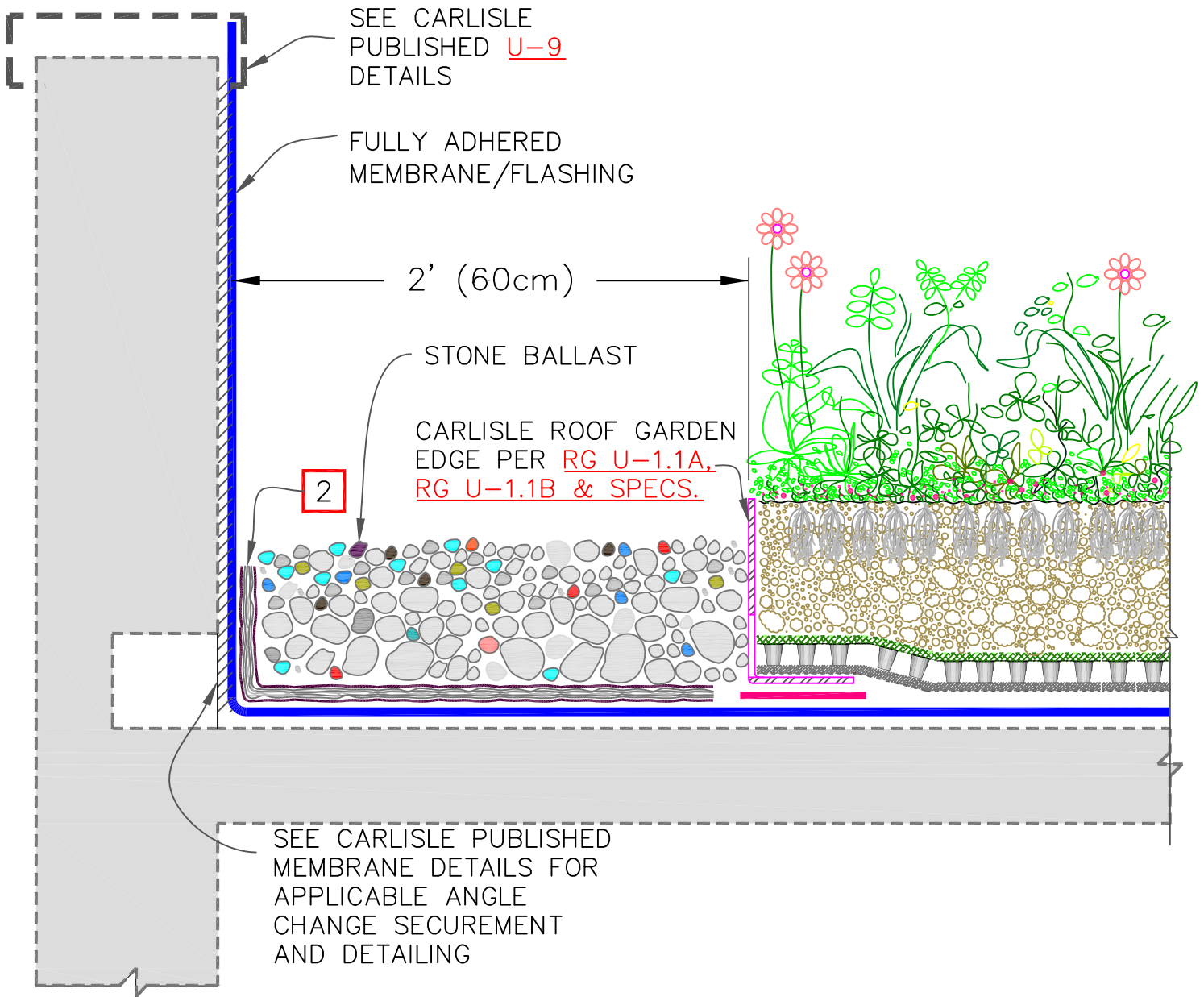

CARLISLE GROWTH MEDIA	ROOF MEMBRANE
MiraDRAIN G4 DRAINAGE COMPOSITE	POLYSTYRENE INSULATION
ROOT BARRIER (40-MIL NON-REINFORCED POLYPROPYLENE)	SEE NOTE(S)
300HV PROTECTION FABRIC	IRMA - INSULATED ROOF MEMBRANE ASSEMBLY

ALL ASSEMBLIES	
FIELD- FABRICATED PIPE FLASHING - STAINED GLASS STONE	
ROOF GARDEN DETAILS	DETAIL NO. RGI 8.2



NOTES:

1. FOR ALTERNATE DETAILS SEE DETAILS [RG 12.3](#), [RG 12.5](#) OR [RG 12.7](#)
2. REFER TO [RG 18.1A](#), [RG 18.1B](#) FOR PROPER DETAILING AT THROUGH WALL SCUPPER.

 → CARLISLE GROWTH MEDIA  → MiraDRAIN G4 DRAINAGE COMPOSITE  → ROOT BARRIER (40-MIL NON-REINFORCED POLYPROPYLENE)  → 300HV PROTECTION FABRIC		 → ROOF MEMBRANE  → POLYSTYRENE INSULATION  → SEE NOTE(S) IRMA → INSULATED ROOF MEMBRANE ASSEMBLY		ALL ASSEMBLIES VERTICAL TRANSITION – STONE BALLAST	
		ROOF GARDEN DETAILS	DETAIL NO. <span style="font-size: 2em; color: green;">RGI 12.1</span>		

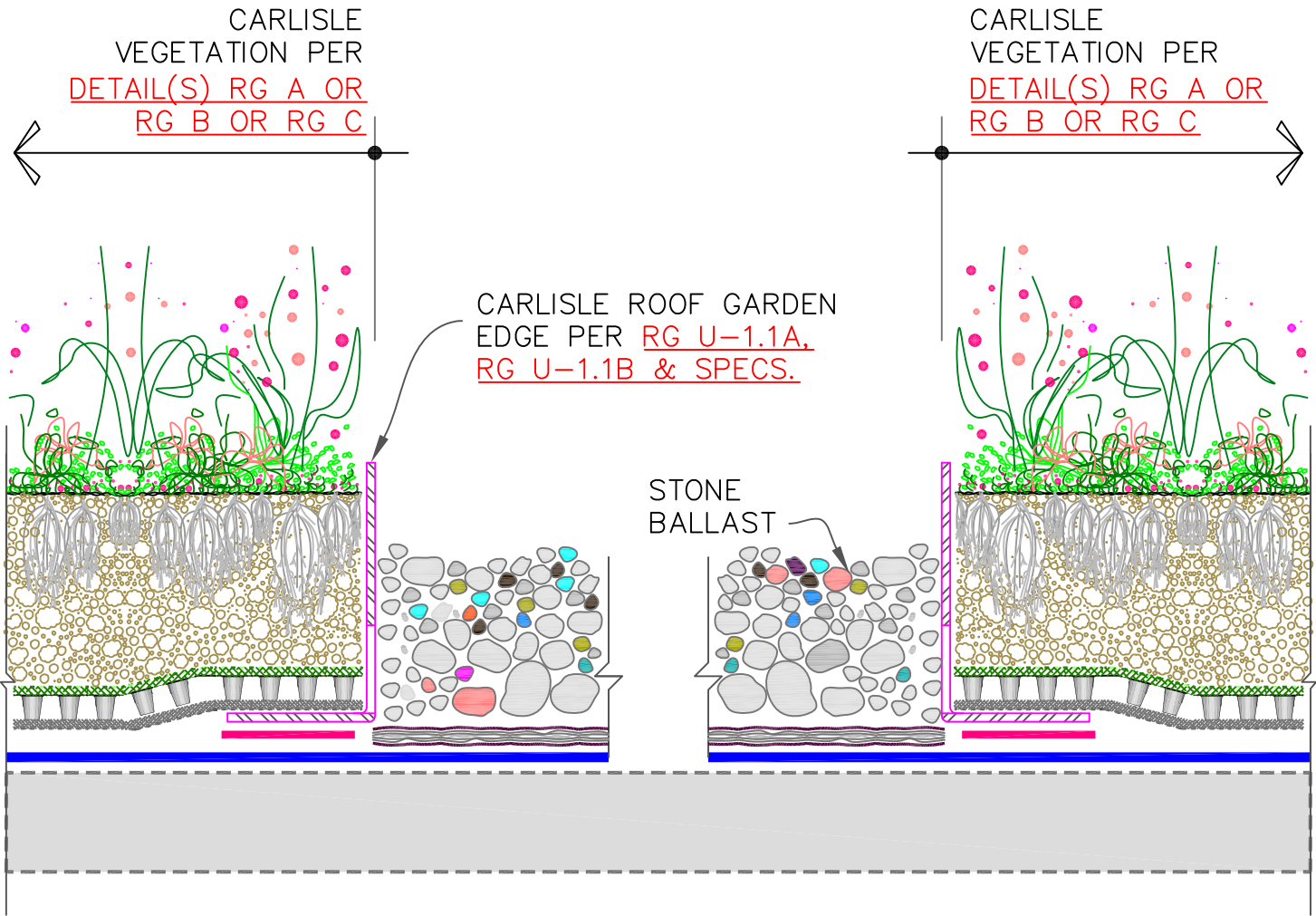

NOTE:

- FOR ALTERNATE DETAILS SEE DETAILS RG 12.3, RG 12.5 OR RG 12.7

(VEGETATION-FREE ZONE)

CARLISLE GROWTH MEDIA MiradRAIN G4 DRAINAGE COMPOSITE RB ROOT BARRIER (40-MIL NON-REINFORCED POLYPROPYLENE) 300HV PROTECTION FABRIC		ROOF MEMBRANE POLYSTYRENE INSULATION SEE NOTE(S) IRMA INSULATED ROOF MEMBRANE ASSEMBLY		ALL ASSEMBLIES HORIZONTAL TRANSITION - STONE BALLAST ROOF GARDEN DETAILS	
				DETAIL NO. <b>RG1 12.2</b>	

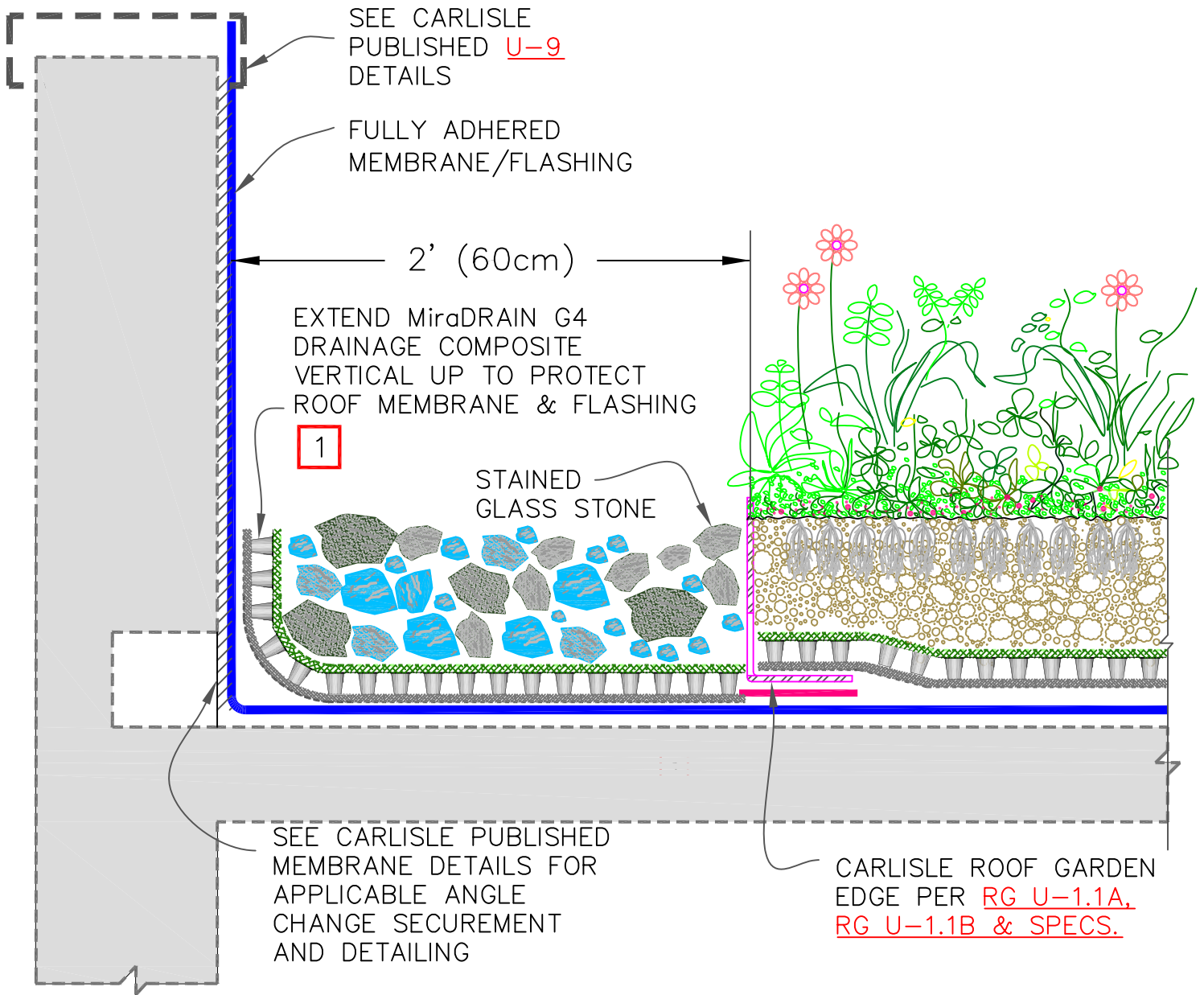

NOTES:

1. DISCONTINUE AT THROUGH WALL SCUPPERS/WALL DRAINS
2. REFER TO [RG 18.1A](#), [RG 18.1B](#) FOR PROPER DETAILING AT THROUGH WALL SCUPPER.

→ CARLISLE GROWTH MEDIA → MiraDRAIN G4 DRAINAGE COMPOSITE → ROOT BARRIER (40-MIL NON-REINFORCED POLYPROPYLENE) → 300HV PROTECTION FABRIC		→ ROOF MEMBRANE → POLYSTYRENE INSULATION → SEE NOTE(S) IRMA → INSULATED ROOF MEMBRANE ASSEMBLY		ALL ASSEMBLIES	
VERTICAL TRANSITION – STAINED GLASS STONE				DETAIL NO.	
ROOF GARDEN DETAILS				RGI 12.3	

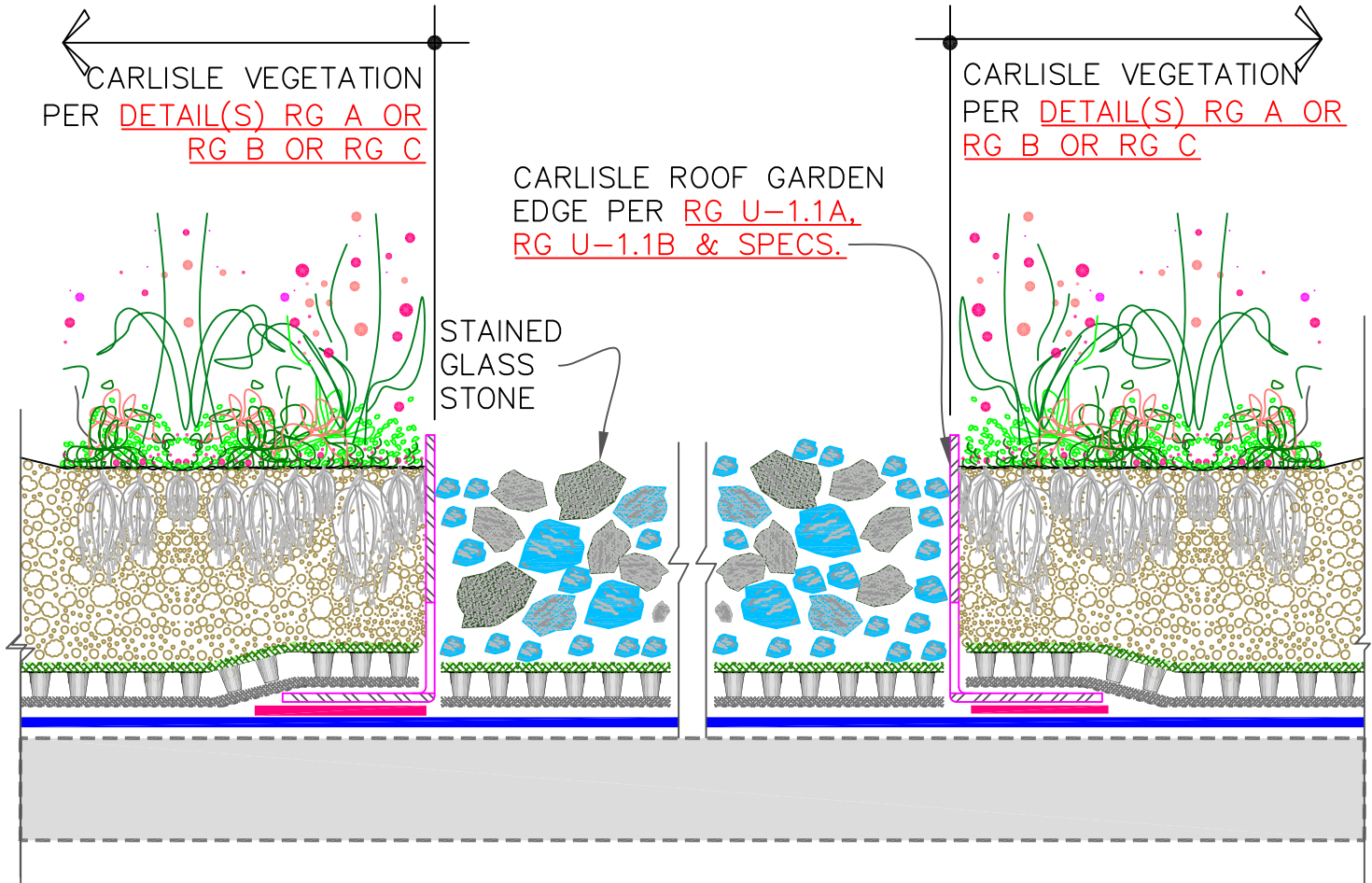





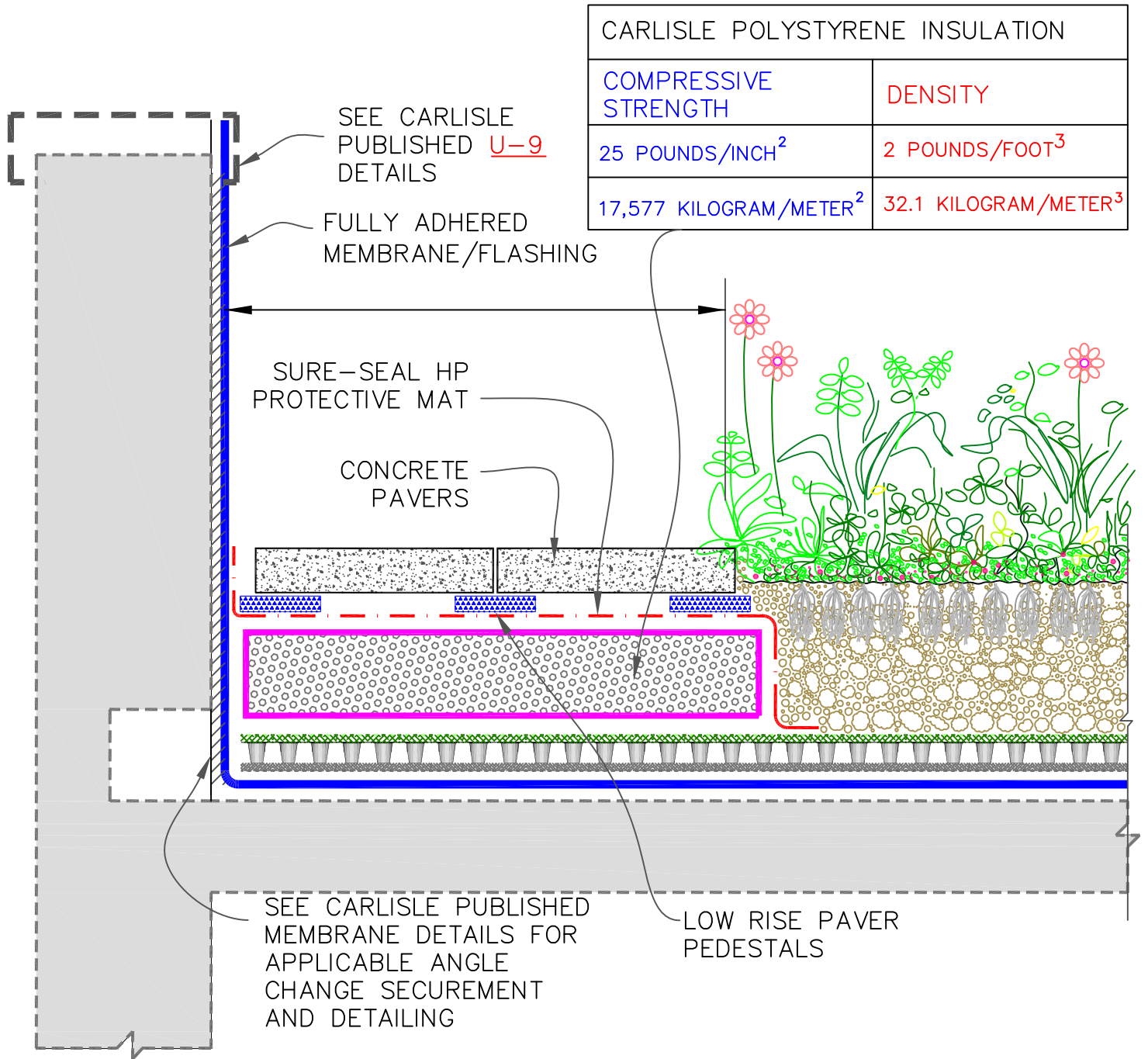

	CARLISLE GROWTH MEDIA		ROOF MEMBRANE
	MiraDRAIN G4 DRAINAGE COMPOSITE		POLYSTYRENE INSULATION
	ROOT BARRIER (40-MIL NON-REINFORCED POLYPROPYLENE)		SEE NOTE(S)
	300HV PROTECTION FABRIC		IRMA - INSULATED ROOF MEMBRANE ASSEMBLY

ALL ASSEMBLIES	
HORIZONTAL TRANSITION - STAINED GLASS STONE	
ROOF GARDEN DETAILS	DETAIL NO. <b>RG1 12.4</b>



ALTERNATE DETAIL **RG12.7**

ALL ASSEMBLIES	
VERTICAL TRANSITION – PAVERS	
2021 ROOF GARDEN DETAILS	DETAIL NO. <b>RG12.5</b>

 CARLISLE GROWTH MEDIA	 ROOF MEMBRANE
 MiradRAIN G4 DRAINAGE COMPOSITE	 POLYSTYRENE INSULATION
 ROOT BARRIER (40-MIL NON-REINFORCED POLYPROPYLENE)	 SEE NOTE(S)
 300HV PROTECTION FABRIC	IRMA — INSULATED ROOF MEMBRANE ASSEMBLY

CARLISLE POLYSTYRENE INSULATION	
COMPRESSIVE STRENGTH	DENSITY
25 POUNDS/INCH <sup>2</sup>	2 POUNDS/FOOT <sup>3</sup>
17,577 KILOGRAM/METER <sup>2</sup>	32.1 KILOGRAM/METER <sup>3</sup>

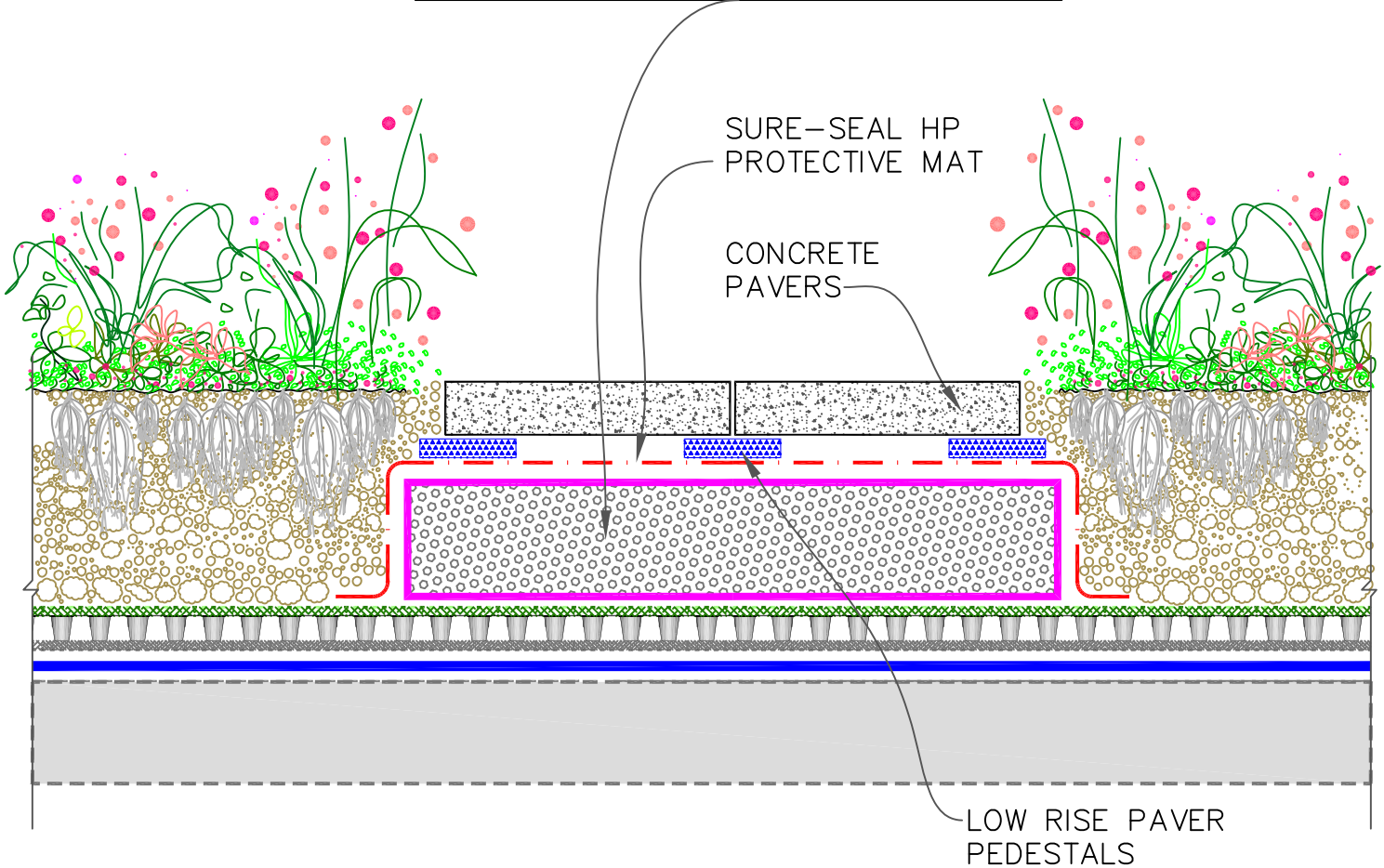

ALTERNATE DETAIL **RG12.8**

ALL ASSEMBLIES

HORIZONTAL TRANSITION – PAVERS

2021 ROOF GARDEN DETAILS

DETAIL NO.

**RG12.6**

	CARLISLE GROWTH MEDIA		ROOF MEMBRANE
	MiraDRAIN G4 DRAINAGE COMPOSITE		POLYSTYRENE INSULATION
	ROOT BARRIER (40-MIL NON-REINFORCED POLYPROPYLENE)		SEE NOTE(S)
	300HV PROTECTION FABRIC		IRMA – INSULATED ROOF MEMBRANE ASSEMBLY

**CAUTION**

CONCRETE PAVERS MUST NOT BE USED AS WALKWAYS NEAR THE ROOF EDGES, PARAPET WALLS AND UNPROTECTED AREAS WITHOUT FALL PROTECTION.

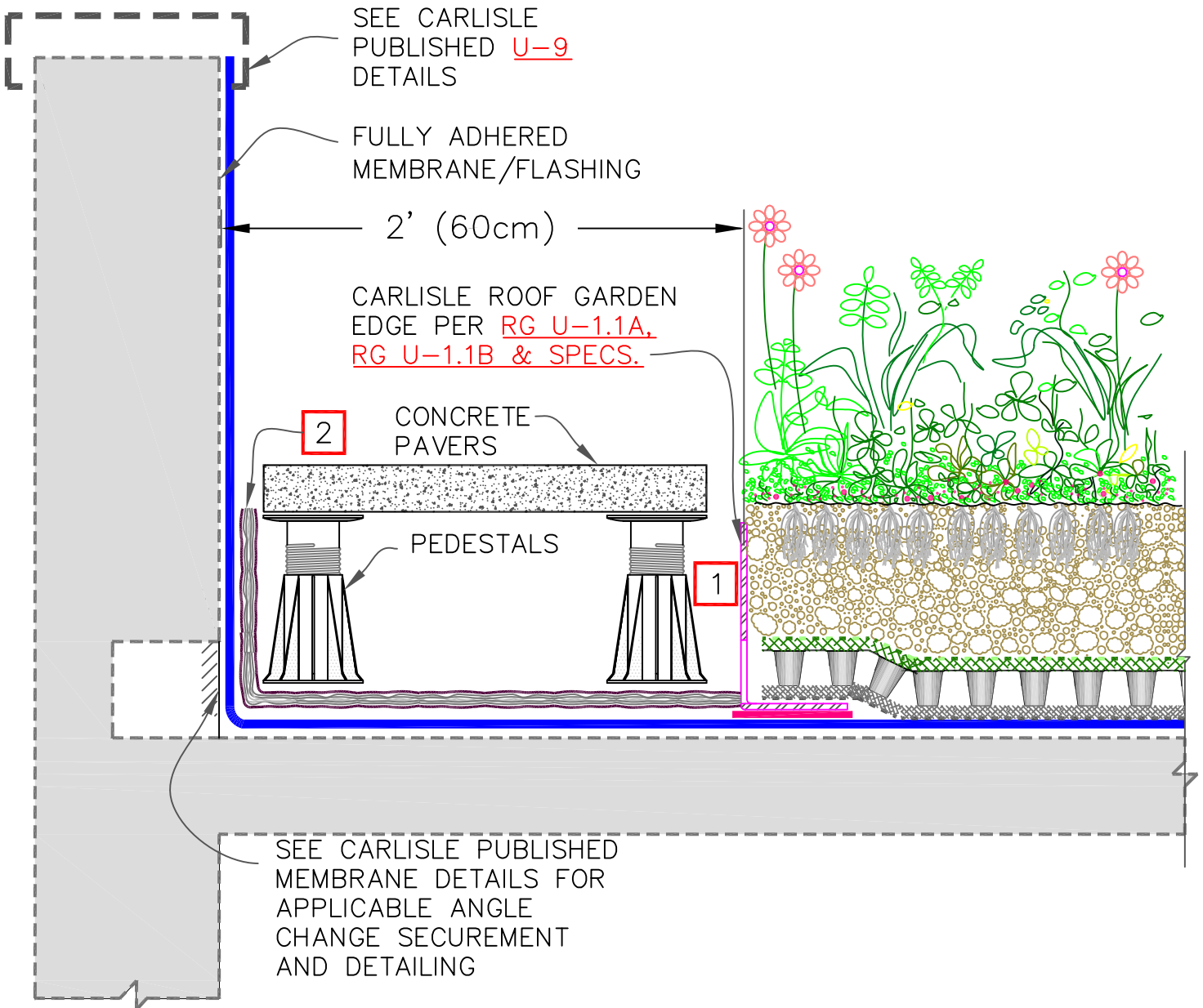

**NOTES:**

1. WHEN PEDESTALS ARE USED WITH PAVERS, ROOF GARDEN EDGE MUST BE USED TO RETAIN GROWTH MEDIA.

2. DISCONTINUE 300HV AT THROUGH WALL SCUPPERS/WALL DRAINS

ALTERNATE DETAIL [RG12.5](#)

<p>● CARLISLE GROWTH MEDIA</p>		<p>● ROOF MEMBRANE</p>		<p><b>ALL ASSEMBLIES</b></p>	
<p>● MiradRAIN G4 DRAINAGE COMPOSITE</p>		<p>● POLYSTYRENE INSULATION</p>		<p>VERTICAL TRANSITION – PAVERS WITH PEDESTAL</p>	
<p>● ROOT BARRIER (40-MIL NON-REINFORCED POLYPROPYLENE)</p>		<p>○ ● SEE NOTE(S)</p>		<p>ROOF GARDEN DETAILS</p>	
<p>● 300HV PROTECTION FABRIC</p>		<p>● IRMA – INSULATED ROOF MEMBRANE ASSEMBLY</p>		<p>DETAIL NO.</p> <p><b>RG12.7</b></p>	

**CAUTION**  
 CONCRETE PAVERS AS A WALKWAY MUST BE LOCATED MIN. 6'-0" (180cm) AWAY FROM THE NEAREST UNPROTECTED ROOF EDGES OR AS REQUIRED PER APPLICABLE LOCAL CODES/OSHA REQUIREMENTS.

CARLISLE VEGETATION  
 PER DETAIL(S) RG A  
 OR RG B OR RG C

CARLISLE VEGETATION  
 PER DETAIL(S) RG A  
 OR RG B OR RG C

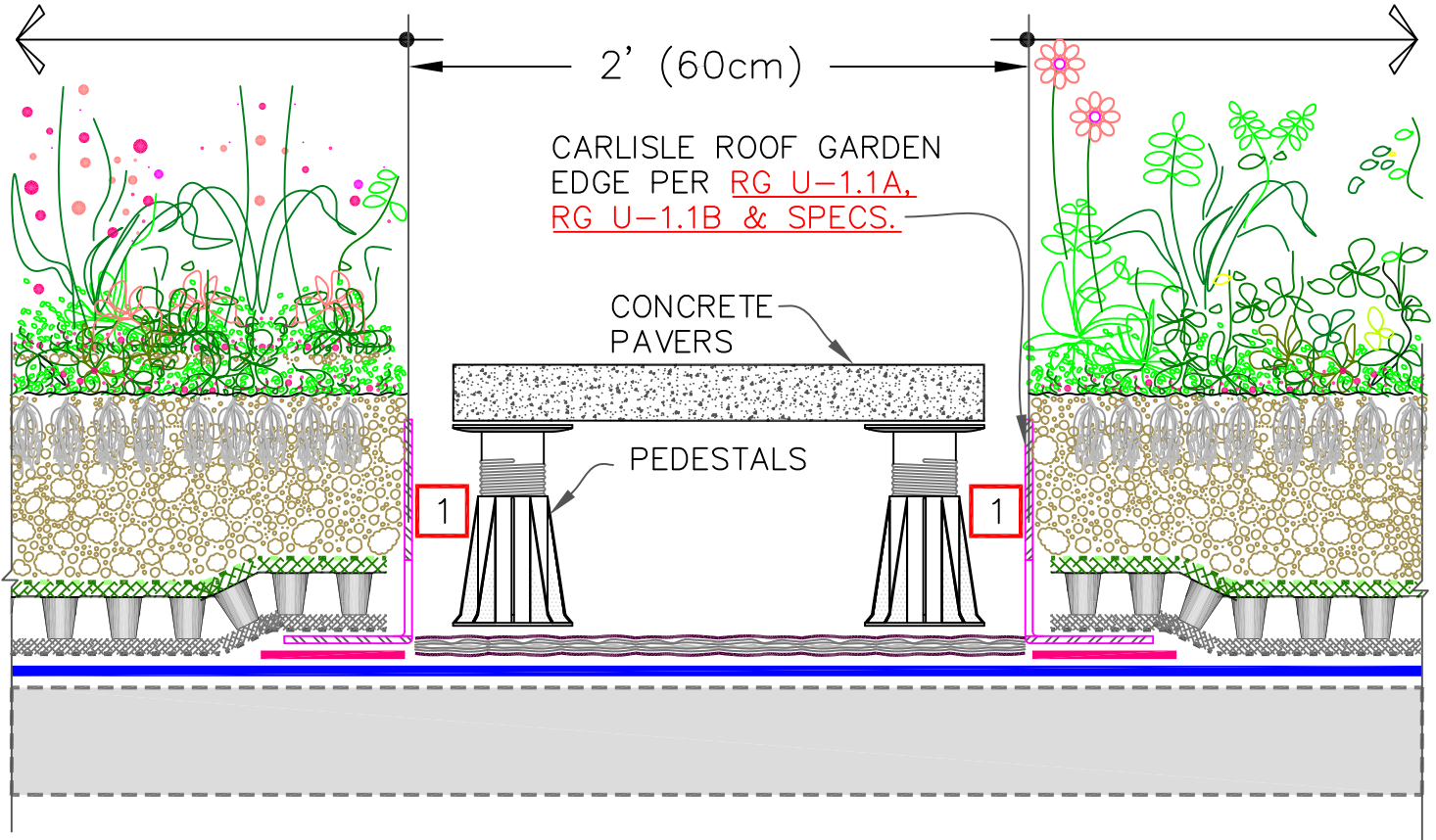

**NOTE:**

1. WHEN PEDESTALS ARE USED WITH PAVERS, ROOF GARDEN EDGE MUST BE USED TO RETAIN GROWTH MEDIA.

ALTERNATE DETAIL [RG12.6](#)

CARLISLE GROWTH MEDIA MiraDRAIN G4 DRAINAGE COMPOSITE ROOT BARRIER (40-MIL NON-REINFORCED POLYPROPYLENE) 300HV PROTECTION FABRIC		ROOF MEMBRANE POLYSTYRENE INSULATION SEE NOTE(S) IRMA - INSULATED ROOF MEMBRANE ASSEMBLY		ALL ASSEMBLIES HORIZONTAL TRANSITION - PAVERS WITH PEDESTAL	
				DETAIL NO. <b>RG12.8</b>	
				ROOF GARDEN DETAILS	

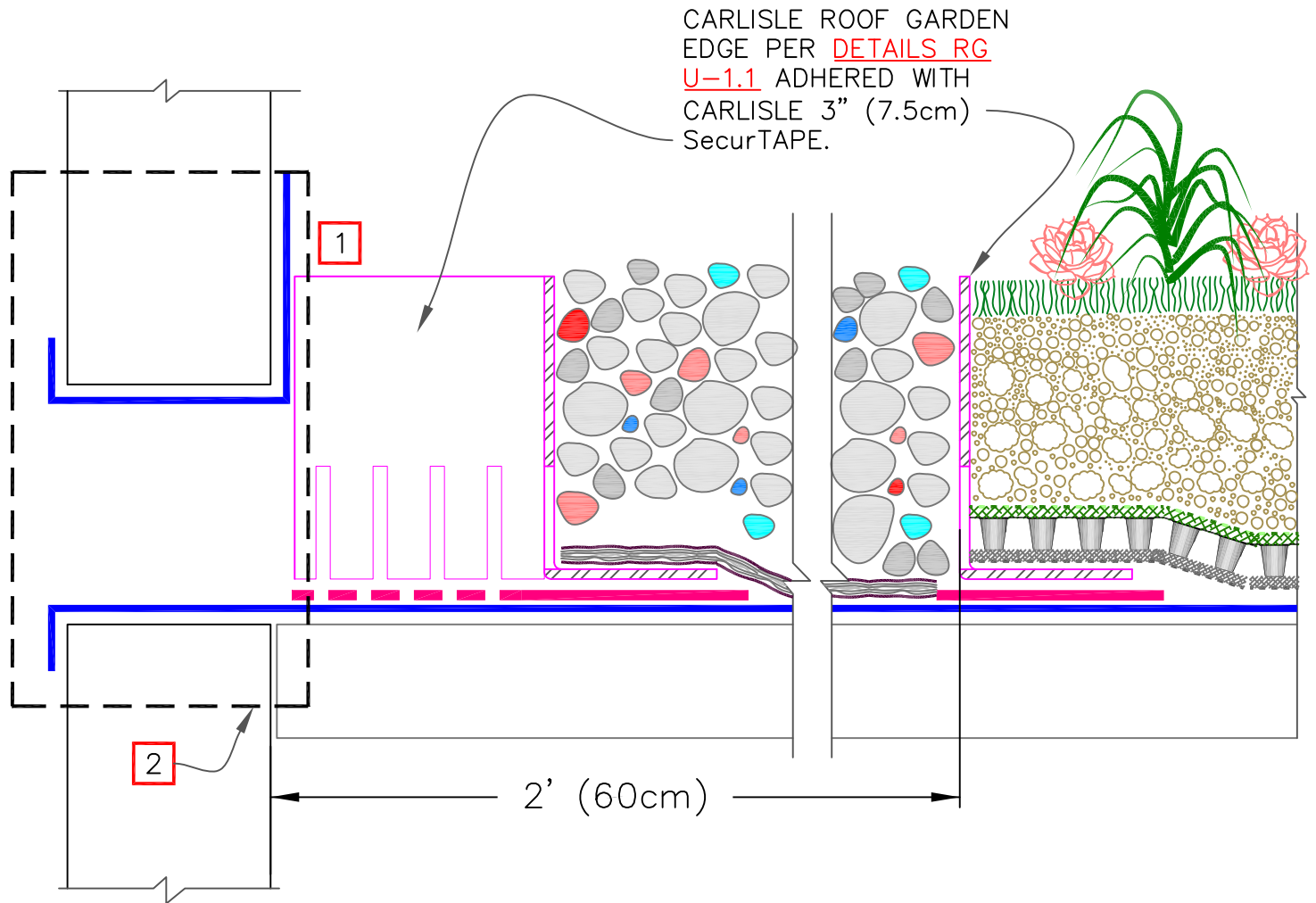

NOTES:





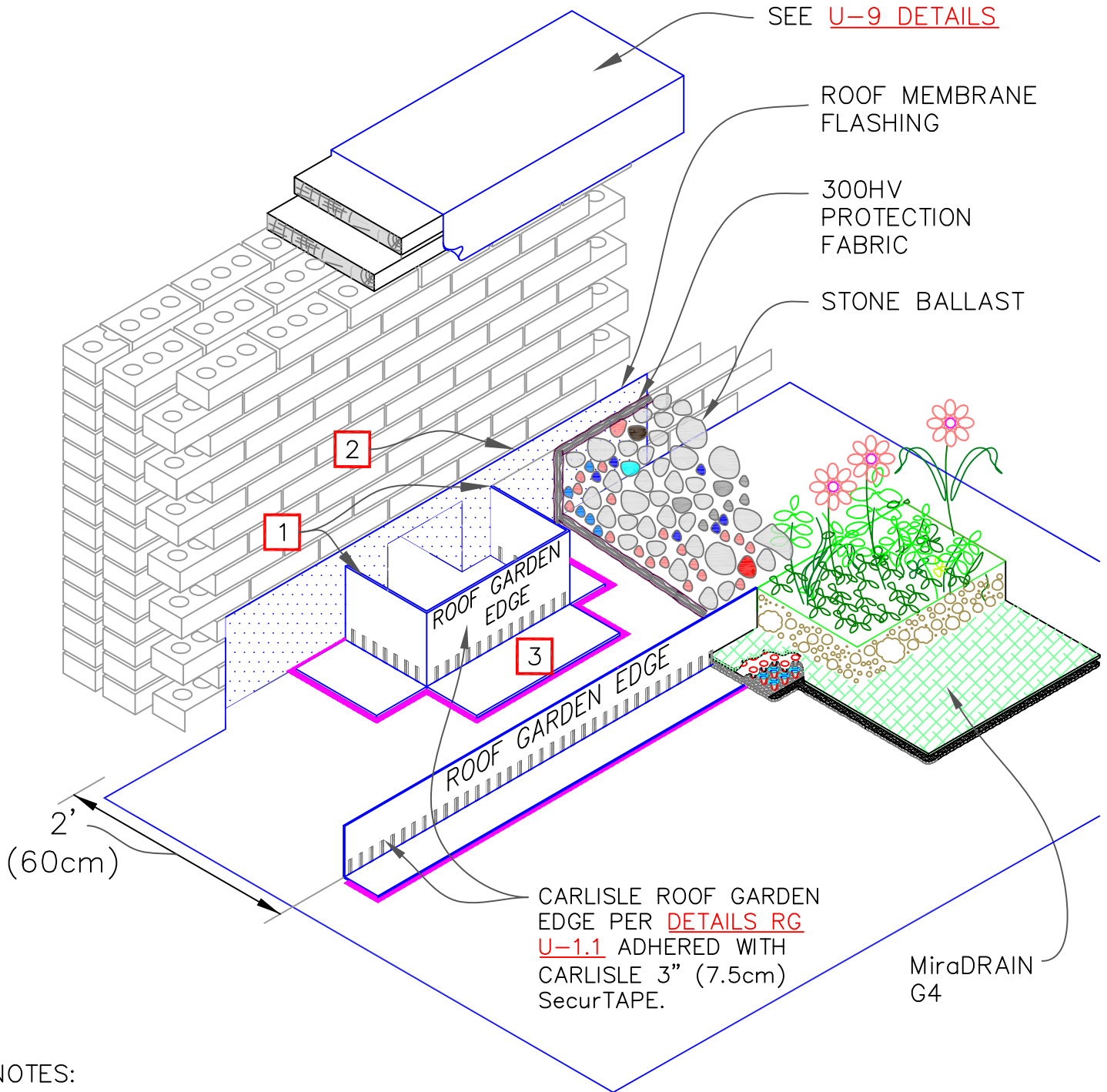

1. ALLOW A 1/4"–1/2" (1–1.5cm) GAP BETWEEN ROOF GARDEN EDGE AND PARAPET WALL.
2. REFER TO SCUPPER FLASHING DETAIL(S) U-18A IN CARLISLE SYSTEM DETAILS FOR THE TYPE OF ROOF MEMBRANE: THERMOPLASTIC OR THERMOSET.

		<p><b>ALL ASSEMBLIES</b></p> <p>ROOF GARDEN THRU-WALL SCUPPER – CROSS SECTION</p>	
		<p>ROOF GARDEN DETAILS</p>	<p>DETAIL NO. <b>RG18.1A</b></p>



NOTES:

1. ALLOW A 1/4"–1/2" (1–1.5cm) GAP BETWEEN ROOF GARDEN EDGE AND PARAPET WALL.
2. REFER TO SCUPPER FLASHING DETAIL(S) U-18A IN CARLISLE SYSTEM DETAILS FOR THE TYPE OF ROOF MEMBRANE: THERMOPLASTIC OR THERMOSET
3. USE ROOF GARDEN EDGE TO BOX OUT SPACE AROUND THROUGH WALL SCUPPER.

 → CARLISLE GROWTH MEDIA  → MiraDRAIN G4 DRAINAGE COMPOSITE  → ROOT BARRIER (40-MIL NON-REINFORCED POLYPROPYLENE)  → 300HV PROTECTION FABRIC		 → ROOF MEMBRANE  → POLYSTYRENE INSULATION  → SEE NOTE(S) IRMA → INSULATED ROOF MEMBRANE ASSEMBLY		ALL ASSEMBLIES ROOF GARDEN THRU-WALL SCUPPER – ISOMETRICS	
		ROOF GARDEN DETAILS		DETAIL NO. <b>RG18.1B</b>	

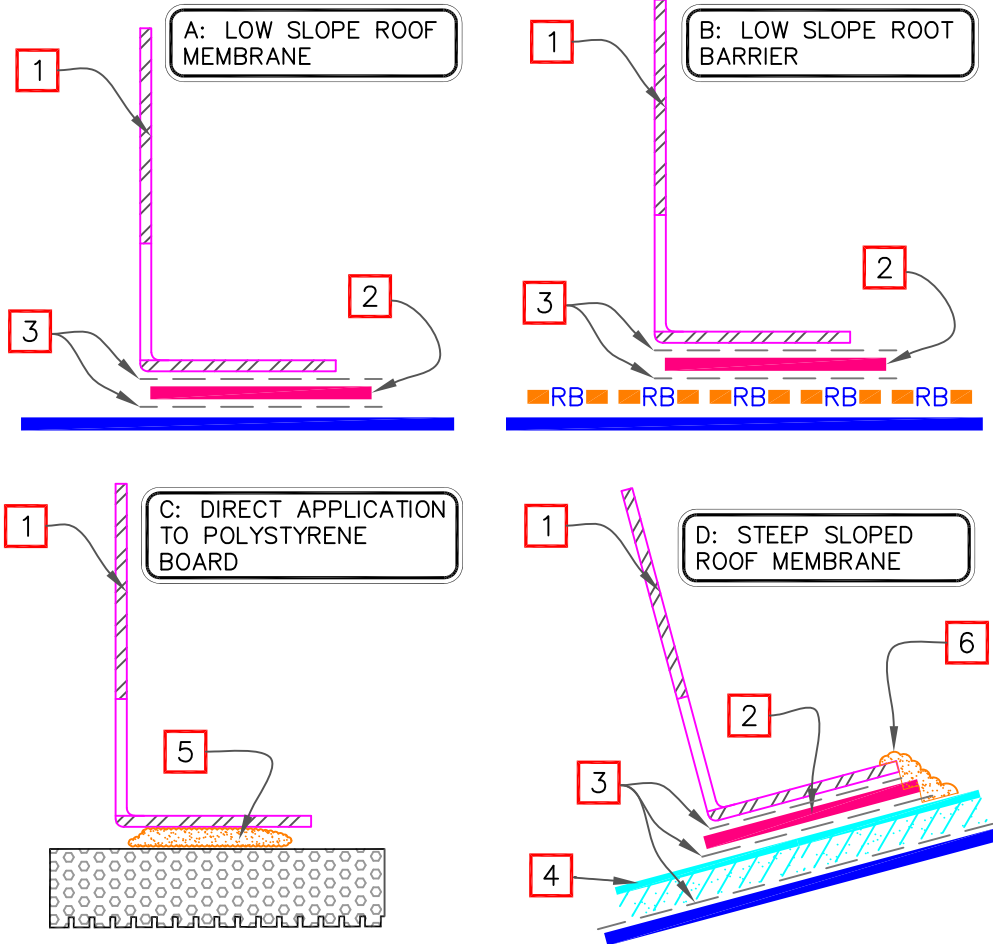

NOTES:

1. CARLISLE ROOF GARDEN EDGE OR CARLISLE EASY BEND ROOF GARDEN EDGE, WITH SLOTTED HOLES FOR DRAINAGE.
2. 3" (7.5cm) WIDE SECURTAPE EXTENDS 1/4" (1cm) TO PROTECT ROOF MEMBRANE FROM METAL BURR & CORNERS.
3. APPLICABLE MEMBRANE PRIMER APPLIED TO MEMBRANE AND EDGING. WHEN APPLYING PRESSURE SENSITIVE MATERIALS TO PVC/KEE HP MEMBRANES, PRIME WITH LOW-VOC PVC STEP 1 ACTIVATOR FOLLOWED BY PVC OR LOW-VOC PVC STEP 2 PRIMER (REFER TO PVC/KEE HP DETAIL U-1G).
4. 6" (15cm) WIDE PRESSURE-SENSITIVE COVER STRIP.
5. CARLISLE UNIVERSAL SINGLE-PLY SEALANT, ONE TUBE EVERY 10 FEET (300cm).
6. CARLISLE UNIVERSAL SINGLE-PLY SEALANT.

→ CARLISLE GROWTH MEDIA → MiradRAIN G4 DRAINAGE COMPOSITE → ROOT BARRIER (40-MIL NON-REINFORCED POLYPROPYLENE) → 300HV PROTECTION FABRIC		→ ROOF MEMBRANE → POLYSTYRENE INSULATION → SEE NOTE(S) IRMA → INSULATED ROOF MEMBRANE ASSEMBLY		ALL ASSEMBLIES ROOF GARDEN EDGES – CROSS SECTION	
				DETAIL NO. <span style="font-size: 2em; color: green;">RGU-1.1A</span>	
				ROOF GARDEN DETAILS	

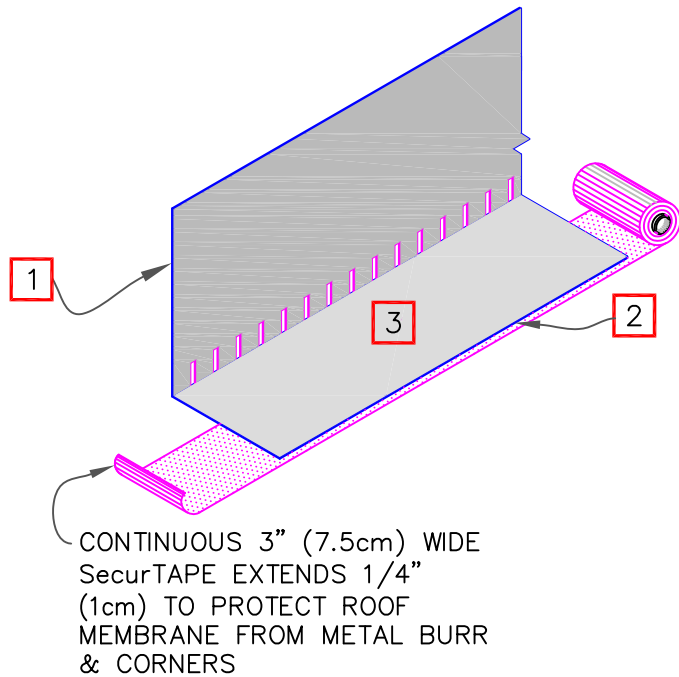

NOTES:

1. CARLISLE ROOF GARDEN EDGE OR CARLISLE EASY BEND ROOF GARDEN EDGE, WITH SLOTTED HOLES FOR DRAINAGE.
2. 3" (7.5cm) WIDE SECURTAPE EXTENDS 1/4" (1cm) TO PROTECT ROOF MEMBRANE FROM METAL BURR & CORNERS.
3. HORIZONTAL FLANGES MUST FACE TOWARDS ROOF VEGETATION ASSEMBLY.
4. PROVIDE 1/8" (0.5cm) SPACE BETWEEN EACH GARDEN EDGE UNIT.

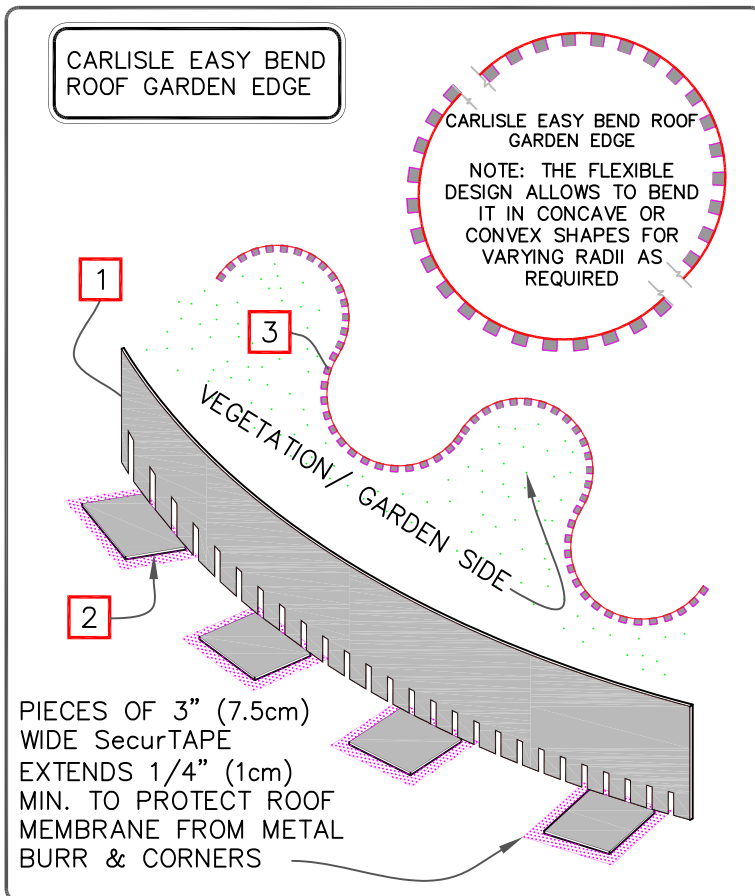

CARLISLE GROWTH MEDIA	ROOF MEMBRANE
MiraDRAIN G4 DRAINAGE COMPOSITE	POLYSTYRENE INSULATION
RB ROOT BARRIER (40-MIL NON-REINFORCED POLYPROPYLENE)	SEE NOTE(S)
300HV PROTECTION FABRIC	IRMA INSULATED ROOF MEMBRANE ASSEMBLY

ALL ASSEMBLIES	
ROOF GARDEN EDGES – ISOMETRICS	
ROOF GARDEN DETAILS	DETAIL NO. RGU-1.1B