



Expanding Your Solutions

Corporate Headquarters
13191 Crossroads Pkwy N., Ste 325
City of Industry, CA 91746
Phone: 800.775.2362
Fax: 626.330.7598

Manufacturing Facilities
City of Industry, CA
Denver, CO
Ft. Worth, TX
Pittsburg, CA

Structural Engineering/Design
1001-A Pittsburgh Antioch Hwy
Pittsburg, CA 94565
Phone: 800.775.2362
Fax: 626.330.7598

Technical Services
13191 Crossroads Pkwy N., Ste 325
City of Industry, CA 91746
Phone: 800.416.2278
Fax: 626.249.5004

1200SSCJ200-68 PUNCHED SURE-SPAN™ C-JOIST 12" DEPTH

Geometric Properties

1200SSCJ200-68 Sure-Span™ floor joist is manufactured with a 2" flange, in 68 mil thickness. All SSCJ joists are available with the large punch-outs at 48" on-center, with the first punch-out 18" from one end. All CEMCO SSCJ load bearing floor joists are produced from hot-dipped galvanized steel in standard CP60 coating. CP90 is available upon special request.

Steel Thickness

Mil Thickness	Design Thickness (in.) ¹	Minimum Thickness (in.) ^{1,2}	Color Code (painted on ends)
68	0.0713" (1.81 mm)	0.0677" (1.72 mm)	Orange

1. Uncoated Steel Thickness. Thickness is for carbon sheet steel.
2. Minimum Thickness represents 95% of the design thickness and is the minimum acceptable thickness delivered to the job site, based on AISI S100.

ASTM's & Code Standards

- ASTM A653/A653M, A924/A924M, & A1003/A1003M, C955, C1007
- UL Classified and UL Certified (UL FUS)
- UL G556, G557, G559, G560, G565, G574, G580, G588, G595, H503, H508, P546, P561, P562
- IBC: 2012, 2015, 2018, 2021
- CBC: 2013, 2016, 2019
- AISI: S100, S200, S240

LEED v4 for Building and Design Construction

- MR Prerequisite: Construction and Demolition Waste Management Planning.
- MR Credit: Construction and Demolition Waste Management.
- MR Credit: Building Product Disclosure and Optimization – Sourcing of Raw Materials, Option 2.
- MR Credit: Building Product Disclosure and Optimization – Environmental Product Declarations, Options 1 & 2.
- MR Credit: Building Product Disclosure and Optimization – Material Ingredients, Option 1.
- MR Credit: Building Life-Cycle Impact Reduction, Option 4.

CEMCO cold-formed steel framing products contain 30% to 37% recycled steel.

- Total Recycled Content: 36.9%
- Post-Consumer: 19.8%
- Pre-Consumer: 14.4%

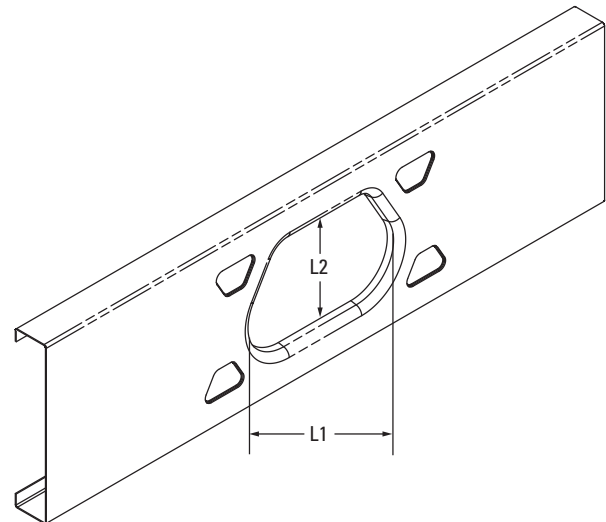

Punch-Out Dimensions

Section	L1 (in.)	L2 (in.)	Spacing Between Punch-Outs (in.)
1200SSCJ200-68	9-1/32	8	48

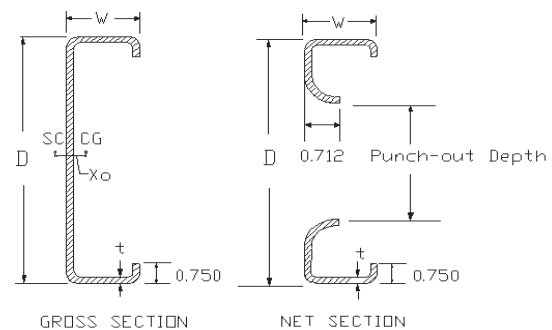

1200SSCJ200-68 Structural Properties & Load Capacities

Dimensions			Gross Section Properties								Torsional Properties					Net Section Properties		Capacities	
w (in)	Gauge	t (in)	Weight (plf)	Area (in ²)	I _x (in ⁴)	I _y (in ⁴)	S _x (in ³)	S _y (in ³)	R _x (in)	R _y (in)	X _o (in)	J _{x1000} (in ⁴)	C _w (in ⁶)	R _o (in)	β	A _n (in ²)	I _{xn} (in ⁴)	M _{all} (k-in)	V _{all} (k)
2.00	14	0.0713	4.114	1.210	22.452	0.524	3.742	0.328	4.308	0.658	-1.070	2.050	14.973	4.487	0.943	0.647	19.679	80.176	2.206

Notes:

1. The yield strength, F_y, is 33 ksi for 18 gauge and 50 ksi for 16, 14, and 12 gauge material.
2. Tabulated weight values are based on full section geometry.
3. Punch-out Depth = 4.25" (web depth 7.25", 8" and 9.25"), 6.25" (web depth 10" and 11.25"), 8" (web depth 12"), 10" (web depth 14")
4. For Allowable Stress Design (ASD) method, use a factor of safety of 1.95 for both moment and shear capacities. This factor of safety is obtained from a joist test program as per AISI 2012, Chapter F.
5. Allowable moment, M_{all}, and shear, V_{all}, capacities for joists are obtained by applying factors of safety to the least nominal capacities (between full and net section capacities).

Technical Services

Technical Services: 800.416.2278
Structural Engineering/Design: 925.473.9340
www.cemcosteel.com



This technical information reflects the most current information available and supersedes any and all previous publications effective April 06, 2022.

04-06-22 AT