



Expanding Your Solutions

**Corporate Headquarters**  
13191 Crossroads Pkwy N., Ste 325  
City of Industry, CA 91746  
Phone: 800.775.2362  
Fax: 626.330.7598

**Manufacturing Facilities**  
City of Industry, CA  
Denver, CO  
Ft. Worth, TX  
Pittsburg, CA

**Structural Engineering/Design**  
1001-A Pittsburg Antioch Hwy  
Pittsburg, CA 94565  
Phone: 800.775.2362  
Fax: 626.330.7598

**Technical Services**  
13191 Crossroads Pkwy N., Ste 325  
City of Industry, CA 91746  
Phone: 800.416.2278  
Fax: 626.249.5004

## 20Z341114 1" Z-FURRING

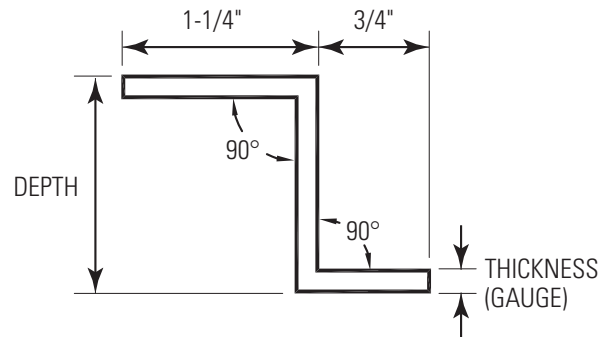
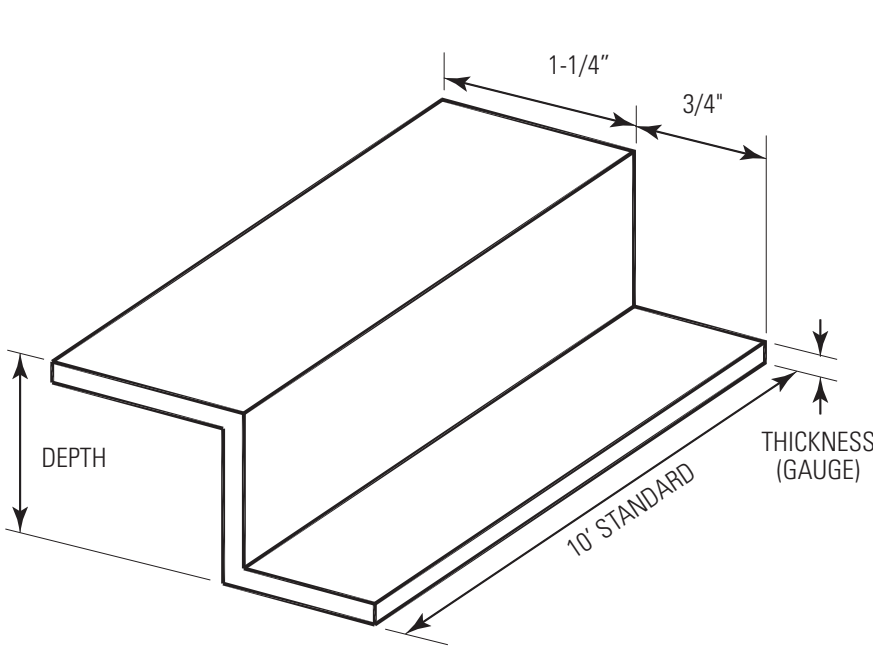

**CEMCO Z-Furring Channel** is fabricated from hot-dipped galvanized steel complying with ASTM A653 with a minimum G40 coating meeting ASTM A924. The furring channel is fabricated from minimum 20 gauge (0.0296" thick) steel (uncoated). The channel is manufactured in various web depths and leg lengths (attachable flange). G60 and G90 coatings are available through special order, and may require up-charges and extended lead times.

Product Code	Depth	Blank Side	Leg Side	Steel Thickness (gauge)
20Z341114	1"	3/4"	1-1/4"	30 mil

**Color Code (painted on ends):** 30-mil: Pink

### ASTM's & Code Standards

- ASTM A653/653M, A924/A924M, A1003/A1003M, C954, C955 and C1007
- IBC: 2012, 2015, 2018
- CBC: 2013, 2016
- AISI: S100-07, S100-12, S100-16, S220-11, S220-15

### LEED v4 for Building and Design Construction

- MR Prerequisite: Construction and Demolition Waste Management Planning.
- MR Credit: Construction and Demolition Waste Management.
- MR Credit: Building Product Disclosure and Optimization – Sourcing of Raw Materials, Option 2.
- MR Credit: Building Product Disclosure and Optimization – Environmental Product Declarations, Options 1 & 2.

- MR Credit: Building Product Disclosure and Optimization – Material Ingredients, Option 1.
- MR Credit: Building Life-Cycle Impact Reduction, Option 4.

**CEMCO cold-formed steel framing products contain 30% to 37% recycled steel.**

- Total Recycled Content: 36.9%
- Post-Consumer: 19.8%
- Pre-Consumer: 14.4%

### Technical Services

Technical Services: 800.416.2278  
Structural Engineering/Design: 925.473.9340  
www.cemcosteel.com



This technical information reflects the most current information available and supersedes any and all previous publications effective December 21, 2018.

12-21-18 AT