



# InsulPure® Fiberglass Building Insulation

Installation Manual



# Welcome

This installation manual provides instructions for installing CertainTeed InsulPure® Fiberglass insulation Batts and Rolls. The manual is based on extensive field testing and covers basic installation procedures. However, it does not cover all variables that may occur in the field.

If you encounter a situation not covered here, we encourage you to call your local CertainTeed representative for consultation.

## Table of Contents

Product Description.....	5
Health and Safety .....	5
Personal Protective Equipment.....	5
Site Preparation .....	7
Re-Entry/Re-Occupancy.....	7
Fire Safety.....	7
Areas to Insulate .....	9
Optimal Insulation Performance .....	11
Air Sealing.....	12-13
Installation Instructions .....	14-19
Specific Applications.....	20-26
Additional Resources .....	27



# Product Description, Health and Safety, Personal Protective Equipment

## Product Description

---

CertainTeed InsulPure® insulation, available in batts and rolls, provides ease of installation and handling. It is less dusty and boasts a softer texture, ensuring a more comfortable installation experience.

### **InsulPure® Insulation offers these benefits:**

**Lightweight and Flexible.** Fiberglass insulation is easy to install with simple hand tools.

**Permanent.** Fiberglass insulation will last for the life of a home without losing its effectiveness. It won't settle or deteriorate over time.

**Thermally Efficient.** A properly insulated home can reduce energy bills\* during the heating and cooling seasons.

**Won't Retain Moisture.** Fiberglass will not retain moisture, which can cause permanent loss of R-value in other products.

**Provides Sound Control.** Fiberglass is an excellent acoustical material in interior and exterior walls, ceilings and floors. Strategically placed, it can act as a sound barrier to unwanted noise from appliances, stereos, TVs, plumbing and ventilation systems.

**Noncombustible.** Because it's inorganic, fiberglass insulation is noncombustible. However, the vapor retarder on most faced insulation products is flammable and should never be left exposed.

**Safe.** Fiberglass insulation is one of the most tested building products in the world. Research into its health aspects spans 50 years and millions of dollars. Fiberglass insulation is safe to manufacture and install when simple practices are followed.

**Environmentally Sustainable.** CertainTeed fiberglass insulation products are made from a high percentage of recycled and renewable content. Sand — the primary raw material used in the manufacture of fiberglass — is an abundant and virtually inexhaustible resource.

\*Savings vary. To find out why, go to [www.energystar.gov](http://www.energystar.gov). Higher R-value means greater insulating power.

## Health and Safety

---

The potential for accidents is always present when working at a construction site. During any installation, you should be fully aware of all applicable OSHA and EPA regulations and practice sound work habits, not only at the site, but also while traveling to and from each location.

1. Take care when loading bags of insulation and other equipment onto your truck. Handle only one bag at a time, being sure to always use proper lifting techniques.
2. Always follow CertainTeed's recommended safety procedures, such as wearing a disposable dust respirator, when installing Sustainable Insulation. Read the WARNING section on the bag for details.
3. Clean up periodically during installation so that you don't trip over the materials you've laid out for the job.

## Personal Protective Equipment

---

When installing fiberglass insulation, the use of several protective items is recommended to minimize the risk of injury and exposure to dust:

- Work gloves
- Eye protection (safety glasses, goggles or a face shield, as appropriate)
- Disposable dust respirator — NIOSH rating of N95 or higher
- Long-sleeve shirt
- Long pants
- Cap or hard hat (a hard hat is recommended in the attic to protect against protruding nails overhead)

**Note: Be sure to wash all work clothes separately. Then run the washer through an extra rinse cycle after removing your clothes.**



# Site Preparation, Re-entry/Re-occupancy, Fire Safety



## Site Preparation

---

1. Remove debris and items stored in the area to be insulated.
2. Remove attic floor boards if necessary to effectively access joist cavities.
3. Remove insulation that is no longer effective because it has become wet or compressed.
4. Inspect for signs of moisture, mold, rot, structural issues or pest infestation. If any are present, seek the assistance of a qualified professional to ensure they are properly resolved before proceeding.
5. Inspect for the presence of knob and tube wiring. If it is present, replace it with modern wiring before installing insulation.

## Re-Entry/Re-Occupancy

---

Installation of fiberglass insulation does not result in any chemical reactions or the release of any solvents into the building air. Therefore, buildings that have been insulated can be re-entered and occupied immediately without health concerns, as long as only the fastening materials listed on page 9 were used.

In some cases, fiberglass insulation is installed in conjunction with other materials, such as spray foam, caulk, construction adhesives, gypsum board and paint. In these cases, the installer should consult the MSDS for each product to determine the appropriate safety precautions.

## Fire Safety

---

Most vapor retarder facings attached to fiberglass insulation are flammable and should not be left exposed. Standard facings should be installed behind, and in substantial contact with, the back surface of wall or ceiling finish materials. Only unfaced fiberglass insulation, or insulation with flame-resistant facings such as CertainTeed's FSK-25 faced fiberglass insulation, can be left exposed.

Clearances around fossil-fuel appliances and flues should meet the requirements of the National Fire Protection Association (NFPA), the appliance manufacturers' instructions, or local code requirements. Use only unfaced fiberglass insulation between wood framing and masonry chimneys. Do not place insulation in air spaces surrounding metal chimneys/flues or fireplaces.

Do not cover lighting fixtures, exhaust fan motors or vents protruding into the attic. Leave a 3" space between the insulation and electric motors or lighting fixtures. Only IC (Insulation Contact) rated lighting fixtures may be covered or be in direct contact with insulation.



# Areas to Insulate

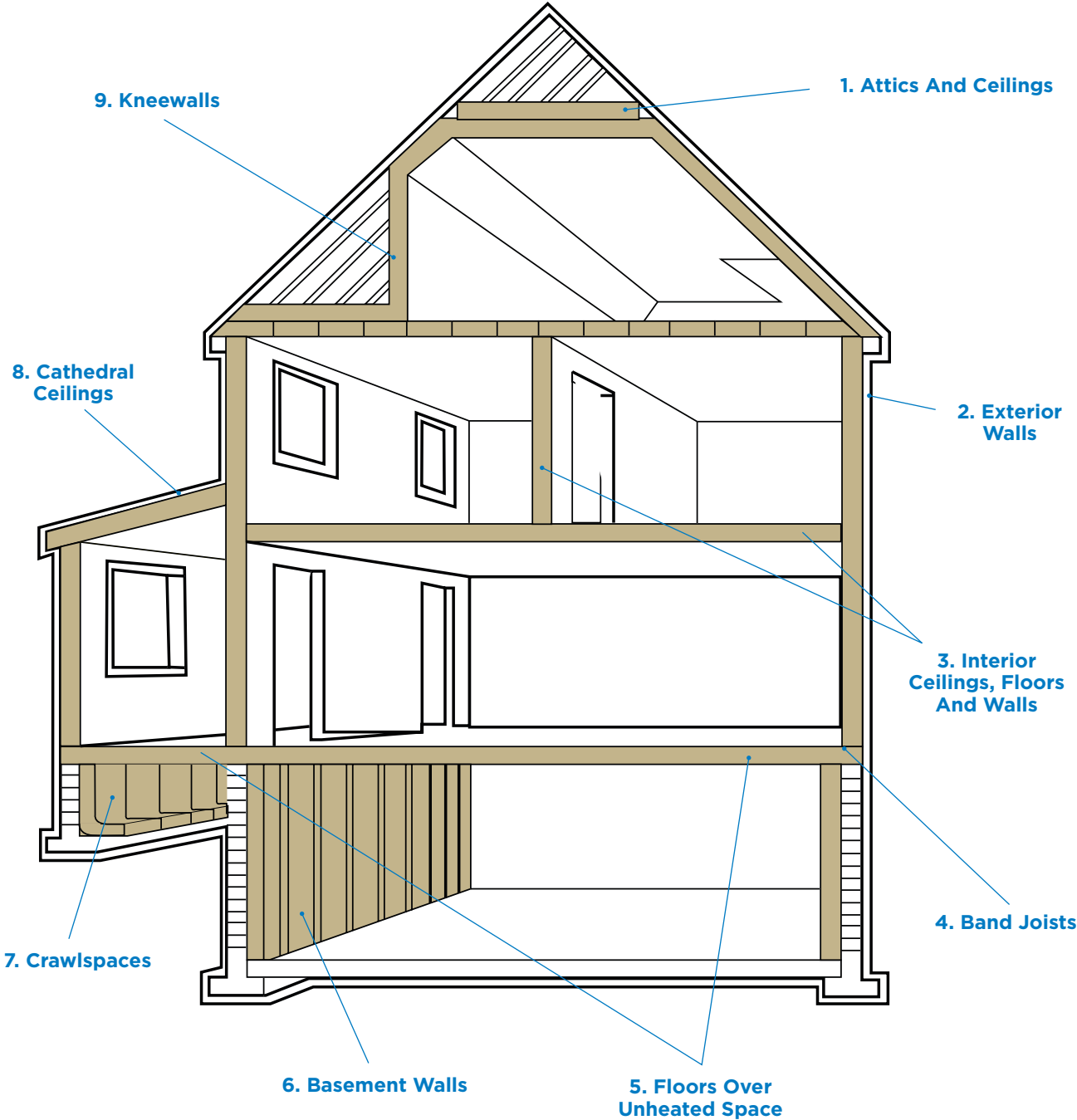

## Areas to Insulate

---

Fiberglass insulation can be used effectively in many locations in a home. The following areas are covered in this manual:

- 1. Attics**, the most important area of a home to insulate. Ceilings with cold spaces above; this includes dormer ceilings.
- 2. Exterior Walls.** Sections that are sometimes overlooked are walls between living spaces and unheated garages or storage rooms, dormer walls, and the portions of walls above ceilings of adjacent lower sections of split-level homes.
- 3. Interior Walls, Ceilings And Floors** where sound control is desired.
- 4. BAND OR HEADER JOISTS**, the wall section between floor levels.
- 5. Floors Over Unheated Or Open Spaces** such as garages and porches.  
Floors over unheated basements. The cantilevered portions of floors and under windows.
- 6. Basement Walls.**
- 7. Floors Above Vented Crawlspace.** Insulation may also be placed on crawlspace floors and walls.
- 8. Sloped Walls and Ceilings** (cathedral ceilings) of attic spaces finished as living quarters.
- 9. Kneewalls Of Attic Spaces** finished as living quarters.

# Optimal Insulation Performance



## Optimal Insulation Performance

---

For fiberglass batt and roll insulation to deliver its rated R-value, it must be installed with minimum compression and gaps, and it should be lofted to its designed thickness. In addition, it should be installed to minimize air flow through it (known as windwashing).

Whenever insulation is installed, it's very important that it fit snugly on all sides. If the insulation is too long for a space, cut it to the correct size. If it's too short, cut a piece to fill the void.

When batts or rolls are compressed to less than their intended thickness during installation, the effective R-value will be reduced.

### Tips for Reducing Compression and Gaps

**Inset Stapling.** Don't inset the tabs any further than necessary for stapling. Alternatively, use friction-fit batts that do not require stapling.

**Cavity Fill.** Cut insulation so it fills all cavities. There should be no gaps on the ends, top or bottom.

**Electrical Wiring.** Split insulation or cut it to fit around wiring.

**Electrical Boxes.** Cut batts to fit around electrical boxes and place a piece of insulation behind each box.

**Plumbing.** Place a layer of insulation between the outside wall and any pipes. If facing is used, make sure it is in substantial contact with the gypsum board.

### Tips for Reducing Windwashing

**Walls.** Install the insulation so that it is completely surrounded by solid air barrier materials. Seal the tops of walls that don't have top plates. Cover walls adjacent to attics, garages and other unconditioned spaces on the exterior side with an air impermeable material such as house wrap, rigid insulation, plywood or gypsum board.

**Attic Floors.** Before installing insulation, seal all openings from the attic into conditioned spaces below, including interior walls, chases and drop soffits. See page 12 for details.

**Attic Eave Vents.** Install vertical blocking and baffles to divert attic ventilation air over and around the ends of attic insulation. See page 19 for details.

# Air Sealing

## Air Sealing

To get the maximum performance out of insulation and to minimize the possibility of moisture condensation in unconditioned building cavities, you must ensure that air leaks are thoroughly sealed.

The most important leaks are places where plumbing, ductwork or electrical wiring penetrates through walls, floors, ceilings and soffits over cabinets. When conditioned air moves through these openings, it carries heat along with it, often flowing right around the insulation. It also carries moisture, which can condense on cold surfaces like roof decking and nails. Narrower openings can be sealed with caulk; if the hole is larger, rigid foam board and spray foam are usually the best choices.

Detailed guidance is available at the U.S. Department of Energy Building America Solution Center (<http://energy.gov/eere/buildings/building-america-solution-center>).

### Above-Grade Walls

Seal all penetrations through the exterior sheathing before installing installation

After gypsum board is installed on the interior, seal all gaps around windows, doors, outlet boxes and other penetrations.

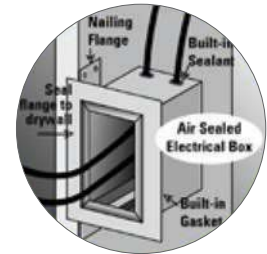

### Below-Grade and Masonry Walls

Seal all penetrations through the masonry, such as holes drilled for electrical and plumbing services, before installing insulation. Seal all penetrations through the masonry, such as holes drilled for electrical and plumbing services, before installing insulation.

After gypsum board is installed on the interior, seal all gaps around windows, doors, outlet boxes and other penetrations.

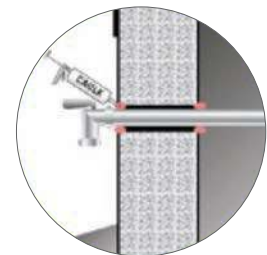

### Floors

Seal all penetrations through the floor into the conditioned space above before installing insulation. These may include holes for plumbing and wiring, as well as chases for ducts and flues.

### Ceilings/Attics

Seal all penetrations through the floor of the attic into the conditioned space below before installing insulation. These may include holes for plumbing and wiring.

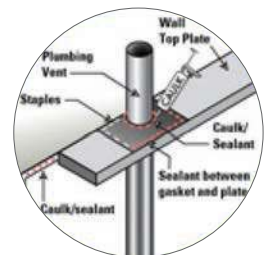

Seal chases where ducts penetrate into attics.

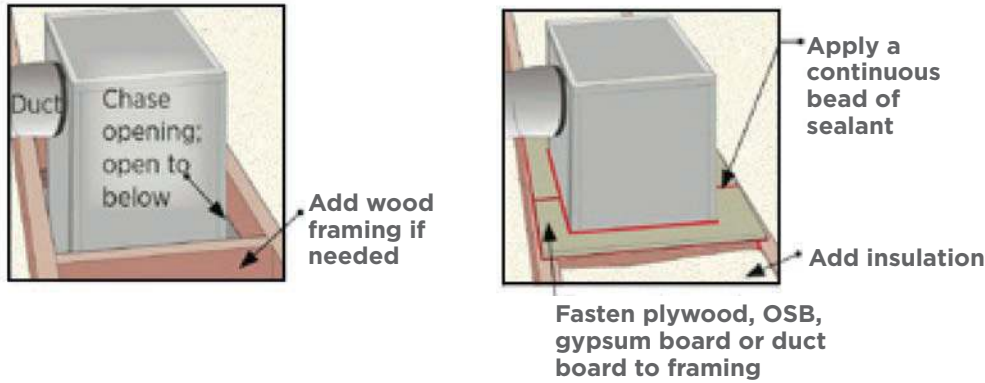

Seal chases where flues penetrate into attics with non-combustible materials. In addition, install dams to keep the insulation a safe distance away.

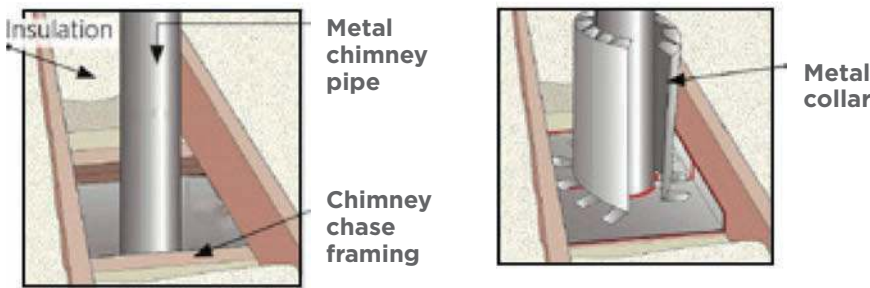

Seal openings in the framing at ceiling height changes and dropped soffits.



Another major area of air infiltration is the attic access opening. This may be a push-up hatch, a pull-down stair or a finished walk-up stairway. These areas should be thoroughly sealed and insulated. There are several insulated attic hatch cover designs that are excellent for this application.

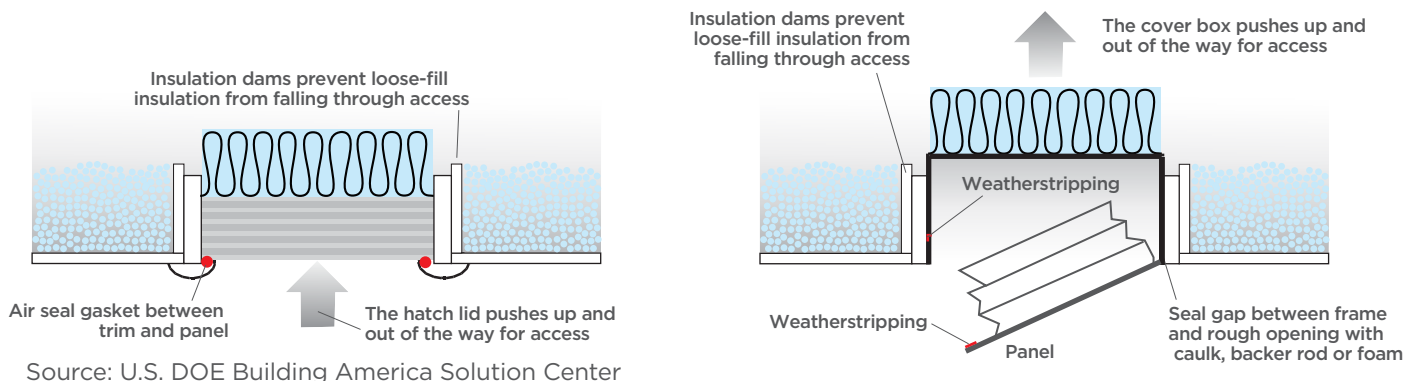

Source: U.S. DOE Building America Solution Center

# Installation Instructions



## Installation Instructions

---

### Training

Specialized training is not required to install fiberglass batt and roll insulation. However, installers should thoroughly read all of the sections in these instructions that apply to the locations where they plan to install insulation. Of course, the guidance of an experienced installer can be very helpful for a beginner or do-it-yourself homeowner.

### Tools You'll Need

The tools and materials required for an insulation project vary, depending on the area of the house being insulated and the type of job — new construction or retrofit. Some equipment, such as the protective gear described on page 3, should be used on every job.

- Utility knife and extra blades
- Tape measure
- Straightedge for cutting the insulation (either metal or a piece of wood like a 1" x 2")
- Stapler (hand-squeeze or hammer type)
- Boards or sheets of plywood to place across joists when kneeling in the attic (they can also be used as cutting surfaces)
- Polyethylene or nylon sheeting if a separate vapor retarder is needed
- Duct tape for sealing tears in the vapor retarder
- Long pole or broom handle for positioning pieces of insulation near attic eaves
- Baffles if insulating near soffit vents

### Recommended Fasteners

The optimal fastener for fiberglass batts and rolls varies with the application. Options include the following:

- Staples can be used to fasten the vapor retarder facing on some insulation to studs, joists or rafters (minimum 5/16" x 3/8" flat crown heavy-duty staples).
- Supports can be used to hold insulation up against floors. These include mesh screen or chicken wire, wire and nails, or wire rods

In cases where the insulation may be exposed to high humidity levels, such as vented crawlspaces, the fasteners should be constructed of corrosion-resistant materials, such as galvanized steel.

### Helpful Hints

- Because packaged insulation is highly compressed and expands greatly when the wrapper is opened, leave insulation in its wrapper until you're ready to use it.
- Use pre-cut batts in walls and floors.
- Use continuous rolls in attics to accommodate larger spans.

### Cutting

To cut insulation, lay it on a board with the facing down, if applicable. Lay a straightedge or 1" x 2" piece of lumber over the area to be cut. Press your straightedge down hard and cut with a utility knife, using the straightedge as a guide. Replace your utility knife blade frequently for large jobs.

## Fastening Methods

Several basic techniques can be used for many different areas where you will be installing insulation.

### Faced Insulation with Stapling Flanges

There are three commonly accepted methods of installing faced insulation in wood framing members.

#### 1. Friction Fit – no stapling

- CertainTeed offers a variety of products that do not require stapling. These products are slightly wider, and the additional width keeps the insulation in place.
- To install faced products by friction fit, gently place the insulation into the cavity space between framing members. Make sure the insulation facing is flush with the face of the stud. The insulation must fit snugly at the sides and ends.
- To install faced products that do not have flanges, follow the same instructions given below for installing unfaced insulation.



#### 2. Face Stapling

- Place the insulation between framing members and check to be sure it fits the cavity at both ends. With facing material flush to the face of the framing, the flanges will overlap the framing. Staple the flanges to the face of the framing, using enough staples to hold the insulation firmly in place (approximately every 8") to avoid gaps and fishmouths.
- The flange of the faced insulation placed in the next cavity will overlap the previously stapled flange. When more than one piece is used, the pieces must be snugly butted.

#### 3. Inset Stapling

- Place the insulation in the cavity and check to be sure it completely fills the cavity, top to bottom.
- Be sure that each piece is butted closely to the next one before fastening. Gently press the insulation at the sides into the framing cavity, until the outside edge of the stapling flange is flush with the face of the framing.
- When inset stapling insulation between inclined or vertical framing members, start stapling at the top and work down. Use enough staples to hold the insulation firmly in place (approximately every 8") and avoid gaps and fishmouths between the flanges and framing.



### Unfaced Insulation

To install unfaced insulation, gently place the insulation into the space between framing members.

It's important that insulation be correctly sized for the cavity and fit snugly at the sides and ends.

Wherever batts or rolls of any type are too short to fill a stud cavity, a piece should be cut to size to fill the gap. When insulation is too long, it should be cut to fit properly, not doubled over or compressed.

## Moisture and Vapor Retarders

A vapor retarder is any material that limits the transmission of water vapor. Every household generates moisture, which is carried through the air as water vapor.

During the heating season, this water vapor moves from a home's warm interior to the cooler exterior. If its passage into attics and exterior walls isn't slowed by a vapor retarder, condensation can occur when the vapor reaches a cold surface. Continued or prolonged condensation can cause wood rot and the growth of mildew and mold. And when fiberglass insulation gets wet, it loses some of its R-value until it dries.

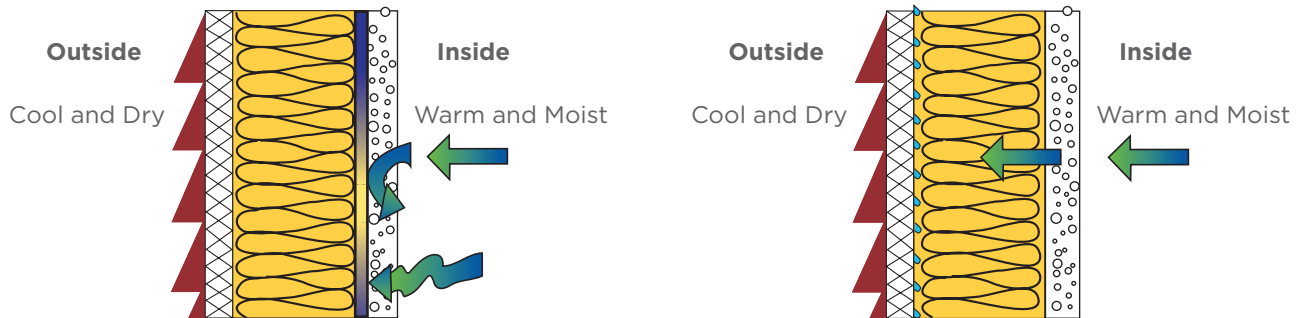

In warm, humid regions with a long air conditioning season and high exterior humidity, water vapor sometimes moves in a continuous flow from the warm exterior to the cooler interior of the home.

Insulation can be purchased with a vapor retarder pre-attached to it. A vapor retarder can also be purchased separately, and then attached after installation of unfaced insulation.

## Types of Vapor Retarders

The International Residential Code defines vapor retarders as Class I, II or III based on how permeable they are to water vapor. The lower the permeability, the less water vapor that will pass through the vapor retarder.

**CLASS I** — Very low permeability vapor retarders, rated at 0.1 perms or less. Sheet polyethylene and unperforated aluminum foil are Class I vapor retarders.

**CLASS II** — Low permeability vapor retarders, rated greater than 0.1 perms and less than or equal to 1.0 perms. The kraft facing on batts qualifies as a Class II vapor retarder.

**CLASS III** — Medium permeability vapor retarders, rated greater than 1 perm and less than or equal to 10 perms. Latex or enamel paint qualifies as a Class III vapor retarder.

CertainTeed offers batt insulation with a variety of facing materials. Consult the product packaging for detailed specifications. For advanced moisture protection, CertainTeed offers MemBrain™. These products provide Class II vapor retarders made from an advanced material that changes its permeability with the ambient humidity condition, allowing closed building envelope systems to dramatically increase their drying potential with seasonal climatic changes.



During the heating season, when indoor relative humidity is typically low, MemBrain works as a vapor retarder.

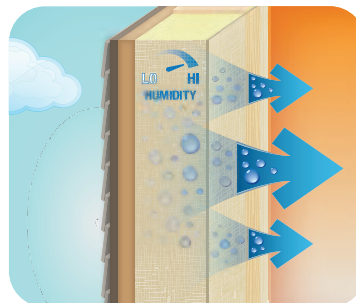

During the cooling season, when outdoor relative humidity is typically high, MemBrain changes its permeance to increase drying potential.

## When Is a Vapor Retarder Required?

Vapor retarders are not a standard requirement for attics. Except for very cold regions, attic vapor retarders aren't required if the attic has adequate ventilation. See the next section for more information on ventilation.

Vapor retarder requirements for walls depend on the climate where the house is located.

### Warm Climate Zones

(Defined as Zones 4, 3, 2 and 1)

The International Residential Code does not require or prohibit the use of vapor retarders in warm climate zones.

CertainTeed recommends using either a Class II or III vapor retarder in these warmer climate zones and not using Class I (very low perm) vapor retarders. Installing a vapor retarder with a very low perm rating on the interior of a wall assembly can lead to moisture problems in warm humid climates, where hot moist conditions tend to drive moisture into the wall from the outside of the building.

In very warm, humid climates, if a vapor retarder is used, CertainTeed recommends installing it to the exterior side of the wall.

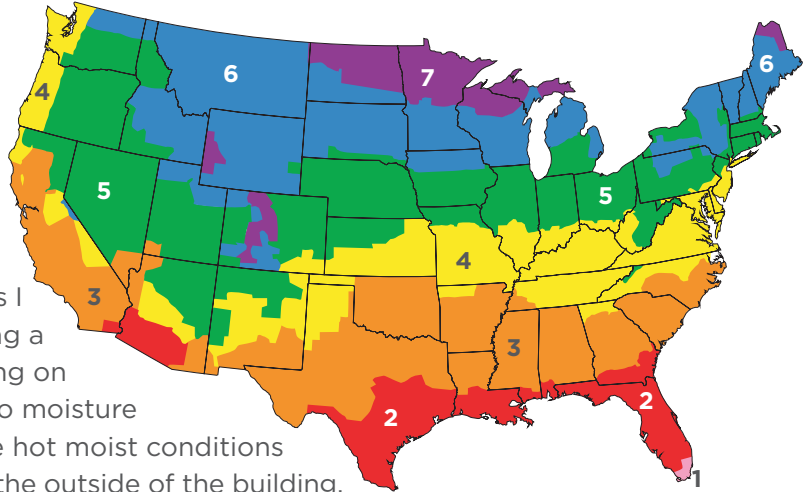

### Cold Climate Zones

(Defined as Zones 8, 7, 6, 5 and Marine 4)

The International Residential Code requires either a Class I or II vapor retarder on the interior side of frame walls in cold climate zones.

A vapor retarder is not required for basement walls or on any portion of the wall that is below ground, or on walls made of materials that can't be damaged by moisture or its freezing.

Class III vapor retarders can be used on the interior side of the wall when the following conditions apply:

### Climate Zone

1, 2, 3 and 4	ALL WALL ASSEMBLIES
Marine 4	<ul style="list-style-type: none"> <li>Vented cladding* over OSB</li> <li>Vented cladding* over plywood</li> <li>Vented cladding* over fiberboard</li> <li>Vented cladding* over gypsum</li> <li>Insulated sheathing with R-value <math>\geq 2.5</math> over 2x4 wall</li> <li>Insulated sheathing with R-value <math>\geq 3.75</math> over 2x6 wall</li> </ul>
5	<ul style="list-style-type: none"> <li>Vented cladding* over OSB</li> <li>Vented cladding* over plywood</li> <li>Vented cladding* over fiberboard</li> <li>Vented cladding* over gypsum</li> <li>Insulated sheathing with R-value <math>\geq 5</math> over 2x4 wall</li> <li>Insulated sheathing with R-value <math>\geq 7.5</math> over 2x6 wall</li> </ul>
6	<ul style="list-style-type: none"> <li>Vented cladding* over fiberboard</li> <li>Vented cladding* over gypsum</li> <li>Insulated sheathing with R-value <math>\geq 7.5</math> over 2x4 wall</li> <li>Insulated sheathing with R-value <math>\geq 11.25</math> over 2x6 wall</li> </ul>
7 & 8	<ul style="list-style-type: none"> <li>Insulated sheathing with R-value <math>\geq 10</math> over 2x4 wall</li> <li>Insulated sheathing with R-value <math>\geq 15</math> over 2x6 wall</li> </ul>

\*Vented Claddings include vinyl lap or horizontal aluminum siding installed over a weather-resistive barrier, typically house wrap or 15 lb. building paper, or brick veneer with a minimum of space of 1" between the brick and the weather-resistive barrier.

## Other Vapor Retarder Considerations

Kraft-faced batts can be installed in all climate zones.

Batts and rolls may be installed one on top of the other in ceilings where there is adequate space. In these cases, only the bottom layer should include a vapor retarder, and it should face down toward the space that is warm in winter. Additional layers of insulation should not include a vapor retarder. If unfaced insulation is not available, faced insulation may be installed, but only after the facing has been completely removed.

## Ventilation

Since vapor retarders (see page 17) work to retard the flow of water vapor from inside homes into attics and wall cavities, you should provide a way for the excess moisture to escape to the outside. This is done by providing adequate ventilation in attics and crawlspaces.

**In the summer.** Proper ventilation prevents the attic from becoming a hot-box that spills unwanted heat down through the attic floor (even if the attic is insulated) into the living area. This can help reduce cooling costs.

**In the winter.** Proper ventilation can help prevent moisture from condensing on the insulation, rafters or roof deck.

## How to Ventilate a Home

**In an attic.** The most common ventilation method is the natural or static ventilation system, which consists of simple vent openings in the attic. Eave vents — openings under the eaves — combined with roof or gable vents provide an effective way to create movement of air through the attic. Always provide at least two vent openings for proper air flow. Air will flow into one opening and out the other.

As a general rule, there should be one square foot of net open vent area for each 150 square feet of attic floor when there is no vapor retarder at the ceiling. If the ceiling has a vapor retarder, provide one square foot of net open vent area for each 300 square feet of attic floor area.

Ideally, 50% of the ventilation should be provided by vents located in the upper portion of the attic, with the remaining 50% provided by eave vents.

When adding insulation to an attic, it's important not to cover eave vent openings and to maintain a 1" space between the insulation and roof sheathing so that air can move freely from the eaves to the ridge or gable vents. Install attic baffles to make sure insulation does not block eave vents and ventilation air doesn't flow into the ends of the insulation.

**In a crawlspace.** Providing at least two crawlspace vents will allow a positive flow of air in and out of the crawlspace. One square foot of free vent area is recommended for every 1,500 square feet of floor area covered with a polyethylene ground cover. (In crawlspaces that are unheated or have a dirt floor, it is recommended, and usually required by code, that the floor be covered with a polyethylene vapor retarder.)

**Cathedral ceilings.** Cathedral ceilings are sloped ceilings where insulation is installed in rafter spaces and the ceiling finish layer is fastened directly to the rafters. In this type of ceiling, a vented air space between insulation and roof sheathing is usually recommended. CertainTeed manufactures special high-density insulation for use in cathedral ceilings that allows for a 1" air space above the insulation. See page 25 for installation details.

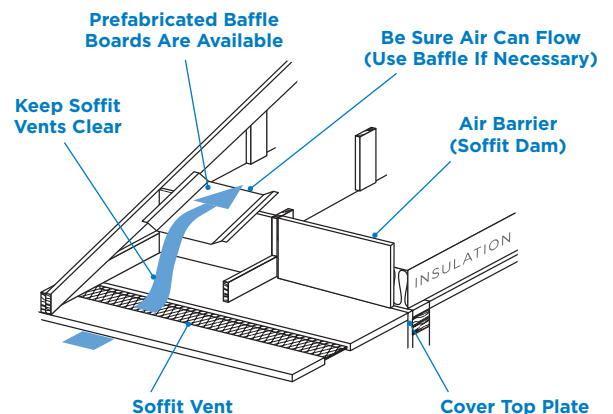

Source: NAIMA

# Specific Applications

## Specific Applications

Following are specific instructions and recommendations for various insulation projects. Be sure to carefully read CertainTeed's installation instructions printed on the packaging of batt and roll insulation to ensure it's properly installed.

### Above-Grade Walls



#### Exterior Sidewalls

Insulation should fit snugly against the framing on all sides. Even the smallest openings between framing members should be insulated.

The vapor retarder should be installed toward the interior of the house except in some warm and humid areas, such as Florida, the Gulf Coast and Hawaii (see page 12).



Fit the end of the batt snugly against the top piece of framing. Working down, staple the flanges, if attached, about 8" apart until you reach the bottom. Fit batts tightly against the framing bottom.

**CertainTeed unfaced batts do not need stapling. Do not leave exposed.**

Split insulation to fit around electrical wires and pipes.



#### Walls of Unheated Garages

If the garage does not have studs, you will have to install them before insulating. This is a relatively easy job. Place studs 16" or 24" apart from the center of one stud to the center of the next.

Place insulation between studs with the vapor retarder toward the interior of the home. Do not leave insulation exposed. Cover with an approved material such as gypsum board. Use only unfaced fiberglass insulation between wood framing and masonry chimneys. Do not place insulation in air spaces surrounding metal chimneys/flues or fireplaces.



## Exterior Sidewalls

Insulate non-standard-width framed spaces by cutting the insulation and facing about 1/2" wider than the space to be filled. Staple the uncut flange as usual. Pull the facing on the cut side to the other stud and staple through the facing to the stud.

Use only unfaced fiberglass insulation between wood framing and masonry chimneys. Do not place insulation in air spaces surrounding metal chimneys/flues or fireplaces.

## Below-Grade Walls



### Semi-Finished/Unfinished Walls

Basement Wall Blanket Insulation is used in semi-finished or unfinished residential and commercial basement areas. It is installed horizontally either in half-wall or full-wall applications (requirements depend on local building code — check with your local building official). For full installation details, please refer to the Basement Wall Blanket Insulation Product Spec Sheet (30-45-052).



### Semi-Finished/Finished Walls

When higher R-values (R-11 or greater) are to be installed on a masonry or concrete wall, a separate frame wall may be built (note: typically 2x4 or 2x6).

Attachment of the insulation to the framing is the same as for above-grade sidewall insulation. In below-grade applications, faced or unfaced insulation may be used, with the vapor retarder applied the same way as above-grade applications. Standard vapor retarder facings must be covered with the interior finish material (paneling, 1/2 inch gypsum board, or other approved material). Only special low flame-spread vapor retarder facing can be left exposed.

## Rim and Band Joists

Rim joists (above the foundation wall) and band joists (between floors) should be air-sealed and insulated. Because no gypsum board will be installed to cover this insulation, air sealing is critical for optimal performance. Unfaced batts should be used for fire safety.

Thoroughly seal all gaps and seams in the framing around the rim joist, band joist, sill plate, wall top plates and floor decking.

Cut the batts so they will friction fit in the cavities with no gaps or compression at the edges. Install the insulation so that it is firmly in contact with the joist surface.

On the long sides of the rim/band joists, it may be necessary to use fasteners to secure the insulation in place. Spray adhesive and wire/twine laced around nails are two options.

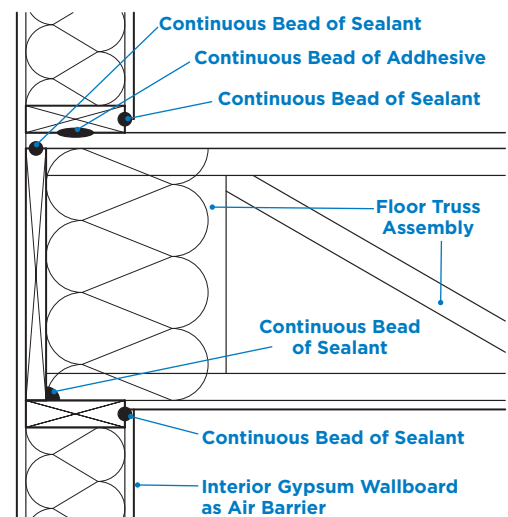

Source: U.S. DOE Building America Solution Center

## Crawlspaces



Before insulating a crawlspace, install a vapor barrier (usually 6 to 12 mil polyethylene sheeting) across the floor to stop ground moisture from entering the space and rising to the floor above, causing mold or wood rot.

Cover the ground with the vapor barrier, overlapping joints by 12" or more. Run it at least 12" up the walls and any center piers. Secure it with construction adhesive, spray foam or furring strips.

### Vented Crawlspaces



If the crawlspace is vented to the outdoors, insulate the floor overhead. If there are ducts or pipes located in this space, be sure to insulate them. See Ducts and Pipes section on page 21 for more information.

Place insulation between the floor joists above your head. Start at one end and work out. Insulation will stay in place temporarily. If faced insulation is used, the vapor retarder should face toward the heated area of the home and be in contact with the floor above.

To prevent loss of heat, be sure the ends of the batts fit snugly up against the band joists, and the batts fit up flush against the bottom of the floor.

If the insulation completely fills the joist space, one of two methods can be used to hold it permanently in place:

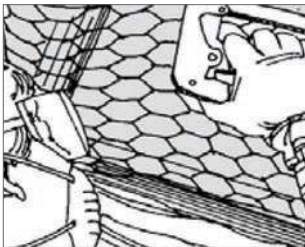

- **Mesh Screen or Chicken Wire.** Use galvanized chicken wire, nylon mesh or galvanized screen to hold the insulation in place. After the insulation has been pushed into place, staple or nail the mesh or screen to the joist faces.

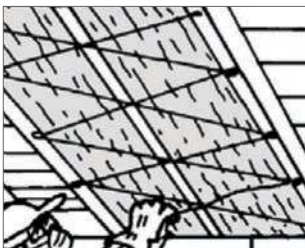

- **Wire Lacing.** Galvanized, malleable wire may be laced around nails protruding from the faces of the joists or the wire may be stapled to the joists. Space the wire and nails as needed to prevent the insulation from sagging.

## Unvented (Conditioned) Crawlspace



An alternative approach to insulating the floor, ducts and pipes is to insulate the crawlspace walls instead. First, identify any vents in the crawlspace walls. Close them so insulation can be placed over them. Seal them if necessary.

Measure and cut lengths of insulation that will extend from the top of the wall down to the ground, plus another 2 feet. Secure the insulation in place at the top by the sill using a furring strip nailed over the insulation. It will now hang down the wall and extend two feet onto the floor resembling an L shape.

## Floors Over Garages

Before installing gypsum board, place insulation between the floor joists above your head. Start at one end and work out. Insulation will stay in place temporarily. If faced insulation is used, the vapor retarder should face toward the heated area of the home and be in contact with the floor above.

To prevent loss of heat, be sure the ends of the batts fit snugly up against the band joists and the batt fits up flush against the bottom of the floor.

If the insulation completely fills the joist space, a gypsum board ceiling can be installed without the need for any additional insulation supports.



When installing insulation in floors that are not as thick as the joist depth, the insulation must be pushed up firmly against the subfloor so there is no air space between the top of the insulation and the subfloor that will allow heat to be lost at outside walls. In this case, the insulation should be secured in place with:

- **Wire Rods.** These are straight, rigid wire fasteners (preferably galvanized) with pointed ends. They are available for a variety of joist spacing. Wedge the fasteners by hand between the joists and bowed upward so the insulation presses gently against the subflooring. Space the fasteners as needed to prevent the insulation from sagging (usually 12" to 24" apart, and not more than 6" from the ends of the batts and rolls).

Once the insulation is secured in place, the gypsum board ceiling can be installed.

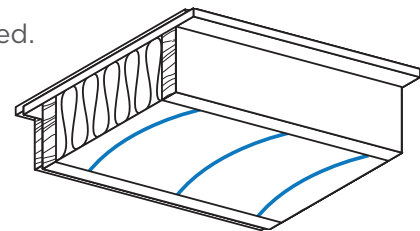

## Ceilings/Attics

Do not cover lighting fixtures, exhaust fan motors or vents protruding into the attic. See page 7 for details.

### Insulating Attics in New Homes

Faced insulation should be used where no insulation exists and where moisture condensation may occur. The vapor retarder should be installed toward the interior of the home.

If gypsum board has not been installed yet, install the insulation from below and staple it in place.

Start installation on one side of the attic, place the insulation between the joists and work toward the center. If necessary, push the insulation under eaves with a broom handle or long stick. If the eave overhangs provide ventilation, be careful not to block the vents and ensure that baffles are in place, as described on page 19.



When using insulation batts, place them one after the other until you reach the center. Simply cut the insulation to fit. Install insulation the same way on the opposite side of the attic, working from eaves toward center.

If you're adding a second layer of insulation, always use unfaced insulation. Lay it across the joists, perpendicular to the existing insulation, and work from eaves toward the center of the attic, butting insulation against the wall at both ends.

If you encounter pipes, beams or other obstructions, cut the insulation to fit snugly around them.

### Adding Insulation to Under-Insulated Attics

Use unfaced insulation over existing insulation, bringing the level of insulation between the floor joists up to the top of the joists.

Starting on one side of the attic, place unfaced insulation across the top of joists, perpendicular to the existing insulation, and work toward the center. If necessary, push insulation under the eaves with a broom handle or long stick. If the eave overhangs provide ventilation, be careful not to block the vents and ensure that baffles are in place, as described on page 19.

If you encounter pipes, beams or other obstructions, cut the insulation to fit snugly around them.



## Cathedral Ceilings

As a general guideline, cathedral ceilings are insulated using the same method as flat ceilings.

The insulation should be stapled or held in place by pressure against the sides of the rafters. An air space

(at least 1") between the insulation and roof sheathing, ventilated at the ridge and soffit, is recommended.

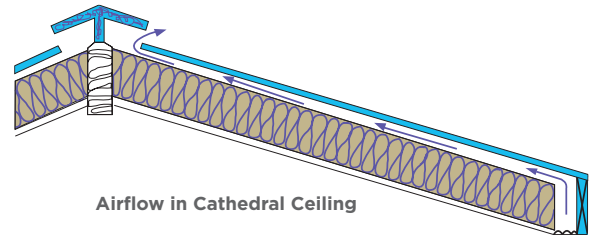

If using kraft-faced insulation, the vapor retarder should be installed toward the interior of the home. Start at the eaves area and work toward the ridge. Make sure the batts are snugly butted together.

If using unfaced insulation, a separate vapor retarder may be applied after the insulation is installed. For more information on vapor retarders, see page 11.

Fit the end of the insulation snugly against the top plate at the beginning of the cathedral ceiling framing. Work upward until the cavity is filled.

Working down the flange, staple about 8" apart until you reach the end of the batt. Do this until the batts reach the exterior walls. Fit batts tightly against each other.

Cover the batts with an approved material such as gypsum board. Do not leave exposed for an extended period of time.

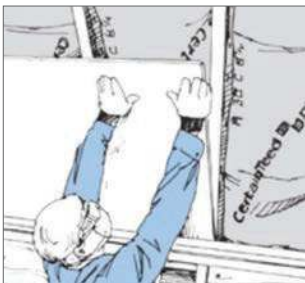

## Attic Kneewalls

Kneewalls are the short low walls that separate conditioned from unconditioned space in a finished attic with sloped ceilings.

These attics can be a source of significant heat loss, so they should be thoroughly air sealed and insulated. The typical treatment is to insulate the walls and floors of these cavities.



After creating access to each cavity, install baffles to allow ventilation air to flow from the eave vents (if present) up over the horizontal insulation in the floor of the cavity (see page 13). Also install baffles to allow the air to flow between the roof deck and the insulation in the sloped ceiling cavities (as described for cathedral ceilings on page 19).

Install blocking under the kneewalls to prevent warm air in the floor cavity under the adjacent room from flowing out into the kneewall attic.

Install batts in the walls. If using kraft-faced insulation, the vapor retarder should be installed toward the interior of the home. Friction-fit batts are well-suited to this application, since the positioning of the facing makes it difficult to secure the insulation with staples.

Install an air barrier material, such as house wrap or foam board, across the attic side of the batts and seal all seams.

Install insulation across the floor of the attic. Start installation on one side of the attic, place insulation between the joists and work toward the center. If necessary, push insulation under eaves with a broom handle or long stick. Seal and insulate the attic access opening.

### Sound Control

Fiberglass insulation is an effective way to reduce unwanted noises from within and outside a home.

The key areas to insulate are exterior and interior sidewalls, ceiling/floor assemblies and the perimeter of any room addition. Interior walls are especially important to insulate in order to keep noise from traveling between rooms.

### Ducts and Pipes

Insulating heating and air conditioning ducts is crucial, especially when they are located in attics and crawlspaces. Wrap metal ducts in fiberglass insulation with a vapor retarder facing to help reduce heating and cooling costs. CertainTeed manufactures a full line of fiberglass HVAC products for all types of homes.

Wrapping hot water pipes with insulation will reduce the loss of heat from the hot water in the pipes. Wrapping all pipes in crawlspaces and attics will reduce the risk of freezing.

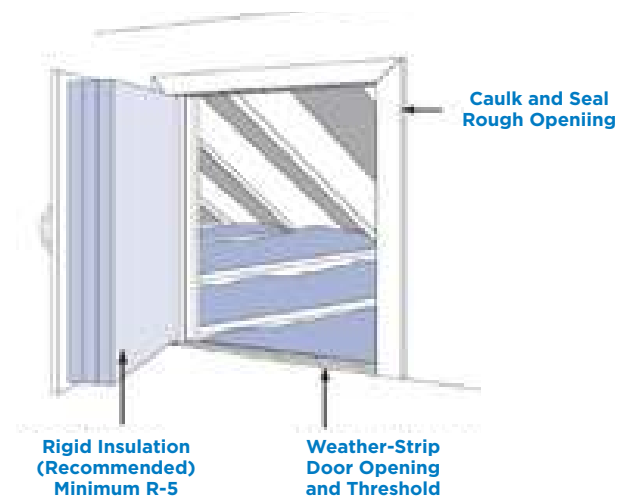
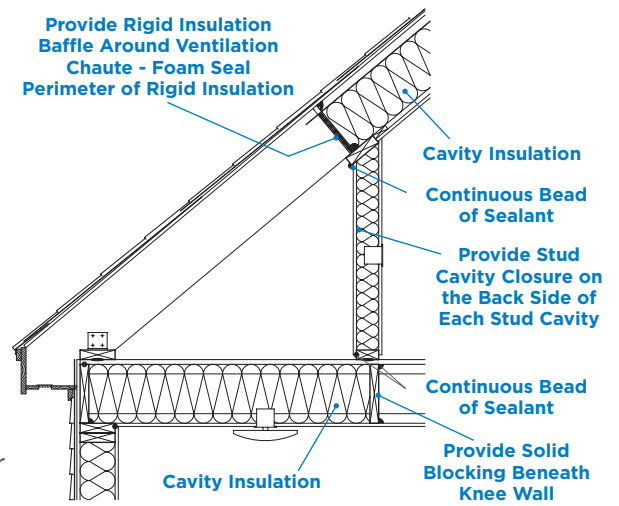

## Additional Resources

---

CertainTeed Insulation Website  
**[www.certainteed.com/insulation](http://www.certainteed.com/insulation)**

North American Insulation Manufacturers Association  
**[www.naima.org](http://www.naima.org)**

NAIMA “Recommendations for Installing Mineral  
Fiber Insulation in Residential and Other Light-Frame Construction”  
**[www.naima.org/publications/BI402.PDF](http://www.naima.org/publications/BI402.PDF)**

U.S. Department of Energy Building America  
Solution Center  
**[www.basc.pnnl.gov](http://www.basc.pnnl.gov)**

ENERGY STAR  
**[www.energystar.gov](http://www.energystar.gov)**

Seal and Insulate with ENERGY STAR  
**[www.https://www.energystar.gov/saveathome/seal\\_insulate](https://www.energystar.gov/saveathome/seal_insulate)**



# Create a More Comfortable Home

**certainteed**  
SAINT-GOBAIN



At CertainTeed, we believe in a higher level of comfort. We believe in Complete Comfort, where your insulation system successfully controls thermal performance, air tightness, moisture management, and acoustics. That's why we offer a complete line of high performance insulation products that work together to ensure every building achieves Complete Comfort.

Learn more at  
[certainteed.com/insulation](https://certainteed.com/insulation)



**CertainTeed**

**CEILINGS • GYPSUM • INSULATION • ROOFING • SIDING • TRIM**  
20 Moores Road, Malvern, PA 19355 800-233-8990 [certainteed.com](https://certainteed.com)