

Shingle Underlayments

5

YOUR OBJECTIVE:

To learn the differences between the various underlayments available.

To learn when a particular type of underlayment is the best choice for a particular situation, and to learn how to correctly install the different types of underlayments.

There are two major types of shingle underlayment: water-resistant and waterproof. Within these types are many variations both between brands and within brands.

UNDERLAYMENT SPECIFICATIONS

WATER RESISTANT UNDERLAYMENT

Two common grades of water resistant shingle underlayment are available; #15, also known as standard shingle underlayment, and #30, also known as heavy duty shingle underlayment. However, within those grades there are many choices. For example, among standard shingle underlayment (#15), the following can be found:

- ◆ **UNRATED SHINGLE UNDERLAYMENT.** Generally the lowest priced and having the most unpredictable levels of asphalt saturation. Quality may vary from batch to batch.
- ◆ **ASTM D 4869 (TYPE 1).** All ASTM rated materials should be superior to “unrated” underlayment. However, an ASTM rating is not enforced by any independent organization. This rating is the “standard” specification for asphalt saturated organic felt shingle underlayment used in roofing.” It covers standard #15 shingle underlayment, also known as “Type 15” or “Type 1.” Because of a higher saturation level this product should not be subject to serious wrinkling.
- ◆ **ASTM D6757 SHINGLE UNDERLAYMENT.** This underlayment is an organic felt reinforced with fiber glass fibers and saturated with asphalt. Generally, they demonstrate a higher resistance to tearing than does any other #15 type underlayment and are very resistant to wrinkling. They typically carry a UL classification, meets the ASTM D6757 standards and all performance requirements of ASTM D4869 and ASTM D226.

There is also a wide selection among heavy duty underlayment products:

- ◆ **UNRATED HEAVY DUTY SHINGLE UNDERLAYMENT (#30).** These heavy duty products are built using a heavier weight of organic felt; however, as mentioned above, unrated products are subject to wide variation in saturation. Under-saturated underlayments are subject to severe wrinkling. Under-saturated #30 underlayment has been known to wrinkle even after shingles are installed, telegraphing the wrinkles through the installed shingles after the job is finished.

- ◆ **ASTM D4869 (TYPE II).** A more predictable quality of heavy duty underlayment, much more resistant to wrinkling.
- ◆ **ASTM D226 (NONPERFORATED).** This is a heavier felt normally used in built-up roofing systems. These felts have a greater asphalt content and exhibit superior strength and resistance to wrinkling.
- ◆ **SYNTHETIC UNDERLAYMENT.** There are a variety of these underlayments made from different synthetic components. All are light-weight and claim superior resistance to tearing and wrinkling. Most of these type underlayments carry one or more performance or approval ratings. (i.e. meets one or more of the ASTM performance standards above, or has one or more industry recognized code-body approval).
 - CertainTeed DiamondDeck® is a synthetic, scrim-reinforced, water-resistant underlayment that can be used beneath shingle, shake, metal or slate roofing.
 - CertainTeed RoofRunner™ is a lightweight synthetic polymer-based water-resistant underlayment for use beneath asphalt shingles.

Both have exceptional dimensional stability compared to standard felt underlayment. and special top surface treatment that provides excellent slip resistance, even when wet.

WATERPROOFING SHINGLE UNDERLAYMENT

Waterproofing Shingle Underlayment (WSU) is a very different kind of material. It is used in vulnerable locations on the roof deck that are most likely to leak during storms with high winds or when ice dams develop. Along the eaves, around roof penetrations and in the valleys are the areas most likely to require waterproof underlayment.

WHEN UNDERLAYMENTS ARE REQUIRED

The installation of water-resistant underlayment beneath shingles is **required** by many shingle manufacturers. Generally, CertainTeed recommends that underlayment be installed but does not require it except as noted below.

LOW SLOPE: All roof shingles applied to a low slope deck (2" to below 4" per foot) require the use of CertainTeed WinterGuard® Waterproofing Shingle Underlayment, or its equivalent,* applied over the entire deck surface. Consult the WinterGuard and individual shingle application instructions for details.

* For low slopes, underlayment equivalents to WinterGuard include:

- 1) waterproofing shingle underlayments meeting ASTM D1970;
- 2) in areas not prone to snow or ice, two layers of CertainTeed DiamondDeck® or RoofRunner™ in shingle fashion (half lap) per the low-slope application instructions.
- 3) in areas not prone to snow or ice, two layers of 36" (915 mm) wide felt shingle underlayment lapped 19" (485 mm).

Shingle underlayment should meet ASTM D6757, ASTM D4869 Type I or ASTM D226 Type I (except when applying LandMark® TL or Presidential® TL Shake shingles).

Because water drains slowly from these slopes, there is a greater chance of water back-up and damage from ice-dams. The application instructions for each CertainTeed roofing product indicate the minimum slope below which the product must not be applied, and a range of slopes where “low slope” application instructions must be followed. These instructions call for the use of a waterproofing shingle underlayment, such as CertainTeed WinterGuard Waterproofing Shingle Underlayment, or it’s equivalent. **However, careful consideration of local weather and the use of a waterproof underlayment meeting ASTM D 1970 are thought to be a good practice and recommended** by CertainTeed. Follow the application instructions for the particular shingle. Note the special low slope application requirements for the products below:

◆ **LANDMARK® TL AND PRESIDENTIAL® TL SHINGLES:**

Low slope application requires a layer of WinterGuard or an equivalent product over the entire roof deck. A **double layer of asphalt felt underlayment is not an acceptable alternative** when applying these products.

COLD WEATHER CLIMATES (ALL SLOPES): Application of WinterGuard or a waterproofing shingle underlayment meeting ASTM D1970 is strongly recommended whenever there is a possibility of ice build-up. Follow manufacturer’s application instructions.

VALLEY FLASHING: Line valley by centering 36" (915 mm) wide CertainTeed WinterGuard, or equivalent,*** in the valley and applying directly to deck. Consult the WinterGuard and individual shingle application instructions for details.

*** For valley liner, the equivalents to WinterGuard include:

- 1) waterproofing shingle underlayments meeting ASTM D1970;
- 2) one layer of 50 lb. or heavier asphalt coated roll roofing;
- 3) one layer of mineral-surfaced roll roofing;
- 4) two layers of 36" (915 mm) wide felt shingle underlayment.
- 5) in areas not prone to snow or ice, a synthetic water-resistant underlayment lapped at 20" and extending through the valley by at least 36". (Coated roll roofing should meet ASTM D224; shingle underlayment should meet ASTM D6757, ASTM D4869 or ASTM D226.)

REQUIREMENTS BY UNDERWRITERS LABORATORIES (UL) FOR FIRE-RATED PREPARED ROOFING

- ◆ UL classified underlayment is required under Class A fire-resistant shingles when plywood or non-veneer (OSB, WB, etc.) APA sheathing is at least $\frac{3}{8}$ " thick but less than $\frac{15}{32}$ ".
- ◆ When sheathing thicker than $\frac{15}{32}$ " is used under fiber glass-type shingles, shingle underlayment is not required for a UL Class A fire rating.

WATER-RESISTANT UNDERLAYMENTS

Water resistant underlayment is a product that consists of organic felt impregnated with asphalt saturant. Some water-resistant underlayments also contain a fiber glass reinforcement which increases tear strength and reduces wrinkling.

There are a variety of these underlayments made from different synthetic components. All are light-weight and claim superior resistance to tearing and wrinkling.

Water-resistant underlayment was originally invented to keep the roof decking dry until shingles could be applied. Applying this underlayment was originally called “drying-in the roof.” It was also useful as a separation sheet between the roof sheathing boards (before OSB and plywood sheets were used as roof decking) and the asphalt shingles. This was important because resin pockets in the pine planks caused the asphalt to degrade prematurely unless the underlayment separated the resin and asphalt from each other.

Water-resistant underlayment is made to shed most of the water that falls on it unless it is torn or punctured. Its ability to be water-resistant is temporary. As the sun degrades the exposed asphalt the materials begin to dry, absorb more moisture, lose its strength and eventually begin to tear. The less asphalt used to saturate the underlayment sheet during manufacturing, the shorter its life. Since asphalt is the most expensive component of shingle underlayment, lower priced materials will have less asphalt and a shorter life when exposed to the sun. Lower priced shingle underlayment, for the same reason, is also subject to severe wrinkling when it gets wet or even just damp.

Underlayment is used under asphalt shingles for a variety of reasons, such as providing:

- ◆ Backup for water-shedding protection of the deck if shingles fail from wind-driven rain. The lower the slope, the more important underlayment is, since water flows more easily under shingles on low slopes.
- ◆ A protective barrier to the elements between the time the old shingles have been torn off and prior to the new shingle being applied. However, the underlayment should not be relied on as a temporary roof system, especially when the drip edge flashing is not yet in place. It is unlikely to prevent leaking in the event of heavy wind and rain.
- ◆ An agent to hide minor imperfections of the decking material and reduce “picture framing” of deck panels.
- ◆ Fire ratings (Class A) when used in conjunction with shingles.

INSTALLATION GUIDELINES FOR WATER-RESISTANT UNDERLAYMENTS

The following is a general guide for the installation of water-resistant shingle underlayment. These guidelines can be used regardless of the weight of the underlayment. However, always be sure to consider the local codes.

Here Are Some Tips...

For roof pitches above 7:12 consider adding a third row of fasteners, making each row 9" apart. Instead of 12" apart. Dennis Torback from Fulton, KS tells us: "I always use Plasti Top nails on felt, it resists tearing under foot and has held up during an unexpected storm with high winds."

OVERNIGHT EXPOSURE

If underlayment has been exposed overnight, moisture from dew should be allowed to completely dry before shingling over. If this does not happen, the moisture will become trapped beneath the shingles. Wrinkling can telegraph through the shingle and make a good shingle job look terrible. The worst part is that the job can look good when you leave in the evening but the wrinkles can reappear the next morning when the homeowner will notice them.

While we've discussed underlayment being exposed overnight, it is suggested that whenever possible the roofing contractor only tear off what he can shingle over that same day. This prevents the most common underlayment installation problems.

APPLYING UNDERLAYMENT BETWEEN SHINGLE LAYERS

CertainTeed advises against applying underlayment over existing roofing. The underlayment may cover or create soft areas in the roof surface. These soft spots can cause shingle fasteners to be under- or over-driven, thereby weakening the shingle hold-down strength (potential blow-offs) or tearing holes in the shingles that can allow water intrusion (potential leaks). Underlayment applied over existing roofing interferes with the ability to nest the new shingles into the old. Nesting is an accepted and time-proven method of applying same-size new shingles over old ones.

So, if the old shingles are to be left in place and the new shingles can be nested into the old, then no additional underlayment is required. There are some who believe that the introduction of an additional vapor retarder between the roofing layers can cause moisture collection and deterioration.

FASTENER TYPE

CertainTeed recommends using nails rather than staples. Nails provide more resistance against underlayment tear out. It is very important, whether hand nailing or using a pneumatic gun, that the fasteners be driven flush.

INSTALLATION METHOD:

When applying underlayment the key is to keep the product as wrinkle free as possible.

1. Unroll the underlayment parallel with the eaves. The eaves edge of the underlayment should go **OVER** the drip edge eaves flashing, but go **UNDER** the drip edge flashing along the rake.

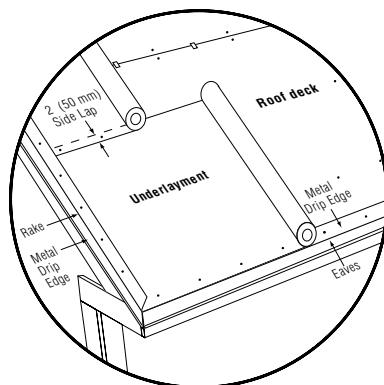

Figure 5-1: Applying Water-Resistant Underlayment Along The Eaves And Rake

2. Around the perimeter of the underlayment, place the nails approximately 6 inches apart and about 1 inch in from the edge. In the main area of the underlayment, two rows of nails are used. The first is placed 12" up from the bottom edge and the second is 24" from that same edge (or in fact 12" from the upper edge). This nicely separates the 36" wide underlayment sheet into thirds. Nail along these two rows 12-15" apart. Nail placement should be alternated so that one row places the nail opposite the open area of the first, creating a sort of zigzag pattern. This will result in a simple pattern with all nails being approximately 12-15" apart. (See tips above.)

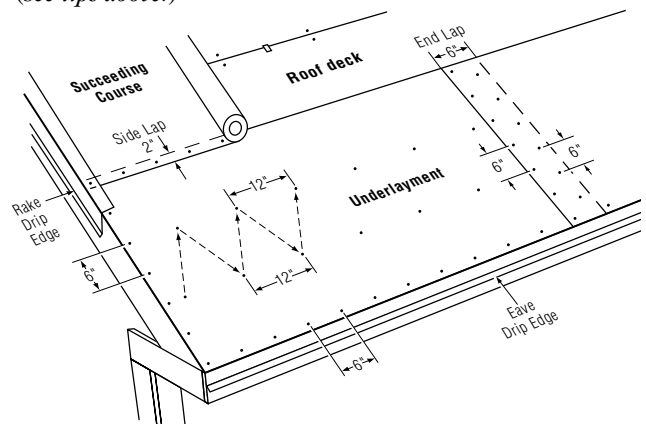

Figure 5-2: Standard Nailing Pattern For Water-Resistant Underlayment

3. Succeeding courses should be unrolled in a similar manner overlapping the previous course by 2". Be careful to roll it out straight as the underlayment will tend to slide down the pitch of the roof and end up crooked. The spacing of nails in this overlap area should be approximately 6" apart, centered in the 2" area. (See tips below.)
4. If the length of the roll is not sufficient to complete the entire run, an end lap of 6" is required. We recommend two rows of nails 6" apart to hold the lapped edges in place. End laps should be located 6-8' from any other end lap that may be in the preceding underlayment course.
5. Apply underlayment a minimum of 6" over hips and ridges, approximately 4" over valley liners and up 4" or more where the roof meets a vertical surface.

WARNING

When installing underlayment where hot vent stacks protrude (from wood burning stoves etc.), it is important to allow a minimum 2" clearance. Check fire codes.

HIGH WIND / OVERNIGHT RECOMMENDATIONS:

If planning to leave water-resistant underlayment exposed overnight, or for a longer period of time, or if high winds are expected, any of the following suggestions or a combination of them can be used for additional protection:

- ◆ Use cap nails or tin caps.

- ◆ Decrease the nailing spacing recommended above, using additional fasteners.
- ◆ Nail 2x4 stringers across lap areas.

DEALING WITH WRINKLES AND BUCKLES

Organic felts expand when wet. They can wrinkle after being applied to a wet deck or if moisture is absorbed from dew, rain, or snow. If shingles are applied over an uneven underlayment surface, some of the wrinkles may “telegraph” (show) through on the finished roof. Of course, wrinkles and buckles can also result from incorrect installation.

If these problems appear, several approaches are available to eliminate them. First, the underlayment can be replaced. Second, the wrinkles can be cut and repaired with patches and asphalt plastic cement. Third, wet and wrinkled underlayment can be allowed to dry out naturally from exposure to the sun. As the underlayment dries, the wrinkles often “pull down” and disappear.

The best solution for wrinkled underlayment is prevention. Applying a high quality underlayment will eliminate many wrinkling type problems. Ask your supplier for the highest quality he can obtain. Do not assume the underlayment he stocks is the best available. Be willing to pay more for a superior product. The cost of high quality underlayment adds very little to the cost of a job and can often be offset by the savings from reduced rework and repair. Installers who insist on the lowest prices for underlayment are the cause of the low quality underlayment generally found in supplier warehouses.

DIAMOND DECK INSTALLATION METHOD:

Apply DiamondDeck® only to a clean, smooth nailable deck. DiamondDeck acts like a vapor retarder; therefore, CertainTeed strongly recommends that it be installed over adequately ventilated attic spaces. Application method is dependent on roof slope, anticipated exposure time, anticipated wind speeds, and climate. If the roof is in a climate where ice damming may occur, then first apply an ASTM D1970-compliant underlayment such as CertainTeed’s WinterGuard® Waterproofing Shingle Underlayment to all eaves. Do not install DiamondDeck as ice dam protection along eaves. Two layers of DiamondDeck cemented together is not an equivalent to WinterGuard.

- ◆ **Standard Slope Roofs (4:12 or Greater):** Starting at the lower edge of the roof, apply DiamondDeck horizontally (parallel to the eave) with printed side facing up. When necessary, overlap vertical side/end joints a minimum 6" and “weather lap” horizontal joints a minimum 3". Offset end laps from course to course at least 36". Fasten as described below.
- ◆ **Low Slope Roofs (2:12 to <4:12):** Starting at the lower edge of the roof, apply DiamondDeck horizontally (parallel to the eave) with printed side facing up. Apply two layers (double coverage) of DiamondDeck in “shingle fashion” as follows:
 - Install a full 25.5" starter strip along the eaves
 - Install a full 48" wide sheet over the starter strip

- Apply each succeeding 48" wide courses up the roof overlapping each previous course a maximum of 22.5" exposure (or 25.5" overlap) in traditional “half-lap” installation or in “shingle fashion”.
- Overlap 12" at all end lap seams and offset from adjacent end laps by 36" minimum. Fasten as described below.

Fastening: DO NOT USE STAPLES!

- ◆ When the finished roofing will be installed **within two days** of underlayment application and high winds are not forecast, standard roofing nails with 3/8" diameter heads may be used. Attach the underlayment at each diamond (◇) printed on the underlayment by nailing a fastener through each diamond (◇) and tight to the surface. Proper fastener spacing is 15" On-Center (O.C.) vertically and 12" O.C. horizontally. On vertical side/end laps install 8 fasteners equally spaced (6" O.C.) centered up the lap to hold the underlayment in place. If wind or rain is expected prior to finished roofing application, it is recommended that 1" diameter plastic or steel cap nails be used in place of standard roofing nails, as described below.
- ◆ When the finished roofing will be installed **later than two days**, CertainTeed strongly recommends using low-profile plastic or steel cap nails with 1" diameter heads to fasten DiamondDeck in place. Attach the underlayment at each diamond (◇) printed on the underlayment by nailing a fastener through each diamond (◇) and tight to the surface. Proper fastener spacing is 15" O.C. vertically and 12" O.C. horizontally. On vertical side/end laps install 8 fasteners equally spaced (6" O.C.) centered up the lap to hold the underlayment in place. All nails and plastic or steel caps must lie flat and tight with the underlayment surface.

Exposure Limitations

DiamondDeck is not designed to be permanently exposed to sunlight and weather or used as a waterproofing underlayment. DiamondDeck is tested for UV resistance for up to 6 months; do not expose it for more than 6 months prior to installing finished roofing.

Lap Sealing

Where laps or joints require sealant or adhesive, use a high quality asphalt roofing cement meeting ASTM D4586 Type II or cements/caulks based on butyl rubber or urethane. It is particularly important to seal all lap seams in areas where the underlayment will be exposed to wind-driven rain.

ROOFRUNNER™ INSTALLATION METHOD:

Apply RoofRunner only to a clean, smooth nailable deck. RoofRunner acts like a vapor retarder; therefore, CertainTeed strongly recommends that it be installed over adequately ventilated attic spaces. Application method is dependent on roof slope, anticipated exposure time, anticipated wind speeds, and climate. If the roof is in a climate where ice damming may occur, then first apply an ASTM D1970-compliant underlayment such as CertainTeed’s WinterGuard® Waterproofing Shingle Underlayment to all eaves. Do not install RoofRunner as ice dam protection along eaves. Two layers of RoofRunner cemented together is not an equivalent to WinterGuard.

Note: . . . The plastic release film on WinterGuard is slippery. Avoid stepping on the release film after it has been removed, or on WinterGuard itself when the release film is still attached.

Here’s a Tip . . . On hot days put WinterGuard in your truck with the AC kicking for 20 minutes to cool it off before working with it. (Thanks to Mark Dulz, Richmond, MI.)

Here's a Tip... In addition to being used for ice-dam protection and valley liners, it is good practice to use WinterGuard to seal around pipes, skylights, chimneys, sidewalls, dormers, roof transitions and other roof areas vulnerable to leaks.

◆ **Standard Slope Roofs (4:12 or Greater):** Starting at the lower edge of the roof, apply RoofRunner horizontally (parallel to the eave) with printed side facing up. When necessary, overlap vertical side/end joints a minimum 6" and "weather lap" horizontal joints a minimum 3". Offset end laps from course to course at least 36". Fasten as described below.

◆ **Low Slope Roofs (2:12 to <4:12):** Starting at the lower edge of the roof, apply RoofRunner horizontally (parallel to the eave) with printed side facing up. Apply two layers (double coverage) of RoofRunner in "shingle fashion" as follows:

- Install a full 25.5" starter strip along the eaves
- Install a full 48" wide sheet over the starter strip
- Apply each succeeding 48" wide courses up the roof overlapping each previous course a maximum of 22.5" exposure (or 25.5" overlap) in traditional "half-lap" installation or in "shingle fashion"
- Overlap 12" at all end lap seams and offset from adjacent end laps by 36" minimum. Fasten as described below

Fastening: DO NOT USE STAPLES OR ROOFING NAILS! CAP NAILS WITH 1" HEADS ARE REQUIRED.

◆ Attach the underlayment at each circular target (○) printed on the underlayment by nailing a fastener through each circle (○) and tight to the surface. Proper fastener spacing is 15" On-Center (O.C.) vertically and 12" O.C. horizontally. On vertical side/end laps install 8 fasteners equally spaced (6" O.C.) centered up the lap to hold the underlayment in place.

Exposure Limitations

RoofRunner is not designed to be permanently exposed to sunlight and weather or used as a waterproofing underlayment. RoofRunner is tested for UV resistance for up to 3 months; do not expose it for more than 3 months prior to installing finished roofing.

Lap Sealing

Where laps or joints require sealant or adhesive, use a high quality asphalt roofing cement meeting ASTM D4586 Type II or cements/caulks based on butyl rubber or urethane. It is particularly important to seal all lap seams in areas where the underlayment will be exposed to wind-driven rain.

WATERPROOFING SHINGLE UNDERLAYMENT

CertainTeed's waterproofing shingle underlayment is called WinterGuard®. WinterGuard is a long-lasting self-sticking modified asphalt on a glass mat reinforcement. In all cases the product must be applied to a clean dry roof deck.* The cost is much higher than standard water-resistant underlayment because of the high percentage of asphalt and polymer modifier. WinterGuard is warranted against leaks and it is not destroyed when nails are driven through it because it seals around nails as they are driven.

* Miami-Dade County acceptance requires the application of WinterGuard over mechanically fastened #30 felt or #43 base sheet, and not directly to the deck. Such application is acceptable only when required by local code in areas where ice damming does not occur. Doing so will not affect the product's limited warranty.

It is designed to seal the roof and prevent water from getting inside a building due to ice dams and/or wind-driven rain. CertainTeed's WinterGuard® Metal is also available for use as a waterproofing underlayment beneath metal, shingle, slate or mechanically-fastened tile roofs. WinterGuard Metal has a slip-resistant film surface designed to improve foot traction and resist high temperatures generated by metal roofs. ASTM standard D1970 applies to WinterGuard, WinterGuard Metal and other similar products.

WHERE IS WINTERGUARD USED?

WinterGuard can be used on both new or existing decks. It is installed beneath shingles, slate, tile, or cedar shakes. Only WinterGuard - HT and WinterGuard Metal can be installed beneath metal roofing. WinterGuard is easy to apply and an excellent underlayment for low-slope shingle applications. It is commonly used to protect against water backup caused by ice dams at the roof eaves. It is also used in critical areas such as valleys, and as concealed flashing around roof penetrations and up sidewalls. In addition, WinterGuard is very useful on roofs exposed to occasional high winds where wind-driven rain can penetrate beneath shingles.

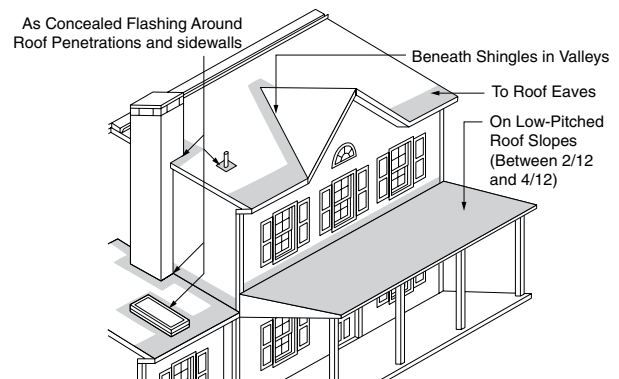

Figure 5-3: WinterGuard's many uses.

THE APPLICATION OF WINTERGUARD OVER OLD SHINGLES

WinterGuard must be applied over a clean, dry deck. Any other application, such as over old shingles, will void the WinterGuard warranty.

WHAT IS THE DIFFERENCE BETWEEN WINTERGUARD AND STANDARD UNDERLAYMENT?

All the No. 15 and No. 30 underlayment products will wrinkle somewhat when dampened. Some will wrinkle very badly. All felt underlayments can leak, especially if they are cut to make them lie flat after they have wrinkled, and they can leak around nails driven through them.

Waterproofing shingle underlayments, such as CertainTeed's WinterGuard, do not wrinkle from moisture absorption. They do not need to be cut to flatten wrinkles, because when properly installed,

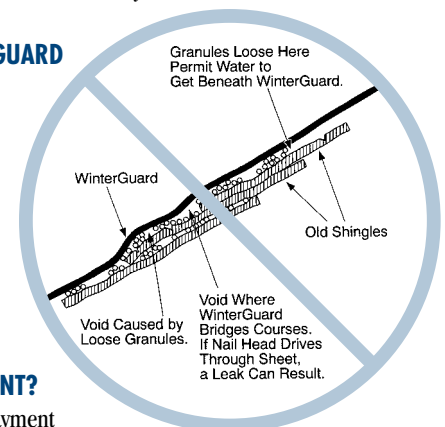

Figure 5-4: Problems with WinterGuard application over old roof.

Here's a Tip... Using the "Fly-In" Method, place your thumbs down. It makes the job easier in hot weather, to let go of the sticky WinterGuard. (Thanks to Mike Dempsey of Eagle River, WI.)

there are no wrinkles. Once adhered, they will not blow off the roof. They do not leak around nails driven through them, because the thick layer of polymer-modified asphalt coating is designed to be sticky and flexible, so it seals around the nails that puncture it. Therefore, these underlayments are not just water-resistant, they are waterproof. But they must be applied fully adhered to a clean, dry wood deck, in accordance with the manufacturer's specifications, in order to get the promised performance. And nails must be properly set according to manufacturer's requirements.

HOW IS WINTERGUARD MADE AND HOW DOES IT WORK?

WinterGuard is a composite material of asphalt and elastomeric polymers reinforced with a fiber glass membrane. It is formed into a rolled sheet. The rubberized asphalt provides the waterproofing. The polymers make the asphalt elastic and sticky all the way through the membrane. This means WinterGuard has the ability to both stretch and cling, and not rip when stressed. It seals like a gasket around nails driven through it. It sticks to a clean roof deck like glue and is warranted to remain effective for the life of the new asphalt shingle system applied over it, up to 50 years.

HERE ARE SOME OTHER FACTS ABOUT WINTERGUARD

- ◆ WinterGuard® is available in two different surface styles – sand and granular. WinterGuard - HT (high tack and high temperature) has a film surface. It is more flexible than sand or granular surfaced WinterGuard and can withstand high temperature roof applications, including metal or tile.
- ★ ◆ WinterGuard® Metal is also film-surfaced and designed for use with metal or mechanically fastened tile roof applications.
- ◆ The standard roll of WinterGuard is 65' in length and 3' wide. One standard roll contains 195 square feet of material. Sand-surfaced WinterGuard and WinterGuard HT also comes in a handy "Short Roll" that is 32 ½' long and 3' wide. It contains 97 ½ square feet of material.
- ◆ A roll of WinterGuard Metal is 61' in length and 39 ⅜" wide containing 200 square feet of material.
- ◆ During installation, an initial light "tack" (stickiness) makes WinterGuard easy to lift if you accidentally put it in the wrong place. The aggressive "tack" of WinterGuard - HT is not as forgiving.
- ◆ Once WinterGuard is installed, however, it locks tight after being warmed by the sun. If an immediate seal is desired, press overlaps firmly with a roller. A heavy-duty wallpaper seam roller or "J" roller works well.

CAUTION:

- ◆ To help prevent shingles from fusing to the waterproofing underlayment, you can cover sand or granular-surfaced WinterGuard with a layer of felt-underlayment or use film-surfaced WinterGuard HT or WinterGuard Metal. Although not required, adopting this practice will serve the property owner and your fellow roofing contractor well when it comes time for the next re-roof.

- ◆ WinterGuard may not come in contact with excessive amounts of petroleum solvent-based cements, such as asphalt plastic cement. For use with WinterGuard, CertainTeed recommends urethanes or polymer-modified cements. Use such materials sparingly.
- ◆ Do not apply over shingles. With the exception of certain roof penetration flashing details do not apply over water-resistant underlayment.*
- ◆ If necessary, you may apply new WinterGuard over an older existing piece of WSU; however, be sure the following conditions are met in order for the WinterGuard warranty to remain in force:
 - The underlying roof deck must be acceptable and in good condition.
 - The existing WSU must have a smooth, clean surface. Nail holes can be present, but all shingles, nails, etc. must be removed and the existing WSU surface swept clean.
 - The surface of the existing WSU must be primed with an ASTM D41 asphalt primer in order to achieve proper adhesion when applying all surface style versions of WinterGuard.
 - All laps must be offset between the existing WSU and new WinterGuard by at least 8".
 - "Feather" the high edge of the WinterGuard over the existing WSU to avoid telegraphing its double thickness.

Note: CertainTeed is not responsible for and disclaims any and all liability for any damage caused by incompatibility of its WinterGuard products when applied over WSU from other manufacturers.

- ◆ Do not use WinterGuard as a permanently exposed roofing surface because it will begin to degrade after too much exposure to ultraviolet light. However, after being properly applied to an acceptable deck, WinterGuard can be left exposed for three to six months (depending on the weather) prior to the installation of the roofing shingles – without significantly damaging WinterGuard's performance in the finished system. When exposing WinterGuard for more than one day, we strongly recommended that you:
 - ◆ Press down all laps with a wallpaper seam roller to assure immediate adhesion. End laps should be 6". Side laps for film and granular surfaced should be 4"; sand surfaced requires a 6" side lap.
 - ◆ Use additional fasteners to hold the sheet in place (especially if cool, windy weather is anticipated).
 - ◆ Close-off holes and joints in the roofs, since the finished roofing system and its flashing components will not be in place to prevent leakage.
 - ◆ Prior to roofing over the exposed WinterGuard, inspect it for damage and replace or recover any worn areas. If any fasteners are removed, the WinterGuard must be replaced or the holes must be filled with one of the adhesives mentioned above so that it remains watertight.

* Miami-Dade County acceptance requires the application of WinterGuard over mechanically fastened #30 felt or #43 base sheet, and not directly to the deck. Such application is acceptable only when required by local code in areas where ice damming does not occur. Doing so will not affect the product's limited warranty.

WARNINGS

- ◆ Always remember that roofing activity can be dangerous. All necessary precautions and safety guidelines should be observed in accordance with proper roofing trade practices.
- ◆ Film-surfaced WinterGuard HT and WinterGuard Metal can be slippery when walked on.
- ◆ When sand-surfaced WinterGuard is left exposed for long periods of time, the sand embedded in its top surface will gradually come loose, possibly creating a slippery condition. Be sure to sweep the loose sand off “long-exposed” WinterGuard before walking on it. If, for any reason, you must leave WinterGuard and WinterGuard Metal exposed for a long period of time, you can possibly avoid the “loose-sand” situation by completely covering the WinterGuard with a standard water-resistant underlayment such as #15.
- ◆ WinterGuard’s release film can be slippery. We suggest that you get the release film off the roof immediately after pulling it off each section of WinterGuard.
- ◆ WinterGuard is applied along the eaves and up the roof no less than 24” beyond the interior wall line to protect against leaks caused by ice dams. In areas of severe icing, it must be applied at least up to the highest water level that might conservatively be expected to occur from ice dams. This will vary by climate, amount of ventilation and insulation, and roof slope. For additional information on ice dams, visit www.certainteed.com.
- ◆ WinterGuard® is a vapor retarder. If you apply it over the entire roof, special care must be taken to ensure there is sufficient ventilation beneath the roof deck to prevent condensation. Refer to Chapter 7 for more information on ventilation.
- ◆ WinterGuard will temporarily lose most of its sticky nature at temperatures under 40°F or even at higher temperatures, depending on its age. We recommend that it be applied in fair weather, at temperatures above 40°. If you need to apply it at colder temperatures, we suggest that you:
 - ◆ Nail it in place with fasteners. Nailing, however, cannot provide protection from ice dams.
 - ◆ Seal the laps with a heat gun or use one of the caulks/adhesives mentioned above.

Installed according to instructions, WinterGuard will become sticky again and adhere when temperatures rise.

DECK PREPARATION

- ◆ Remove all roofing material down to a clean, dry, and smooth deck.
- ◆ Get rid of anything that is sticking up, such as nails or wood splinters. Also eliminate dust, dirt, loose objects, and moisture.
- ◆ If you are covering a concrete or masonry roof surface, prime the surface first with an asphalt primer meeting ASTM D41 requirements. Follow the manufacturer’s instructions for applying the primer. The primer must be dry before installing WinterGuard.

THREE INSTALLATION METHODS

(1) THE “ROLL-OUT” APPLICATION METHOD

NOTE: This method requires two workers.

1. WinterGuard can be applied in any length convenient to the applicator.
2. First, unroll the material (keeping protective release film in place), line up with the lower edge of the roof, and hold it in place.

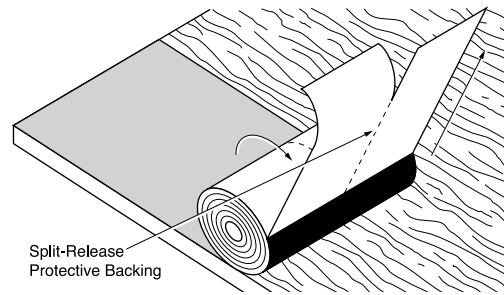

Figure 5-5: Application using the “Roll-Out” method

3. Lift the starting-end of the material (approximately 1'), peel back, and fold under at least 6" of both protective release film sections.
4. Carefully return the exposed adhesive surface to the deck and press it firmly in place. It is recommended that you walk over WinterGuard to set it firmly to the deck.
5. If it's cold and the material does not stick immediately, tack in place with a few fasteners.
6. Reroll the material from the other end until the peeled and folded-back film is exposed.
7. Beginning with the already peeled release film, continue to peel both sections of film from the roll, pulling the roll parallel to the eaves (Figure 5-5). Be sure the WinterGuard lays flat and is sticking well.
8. Press overlaps firmly into place with a hard roller.

(2) THE “PEEL AND FLOP” APPLICATION METHOD

NOTE: This method is recommended for one-worker applications.

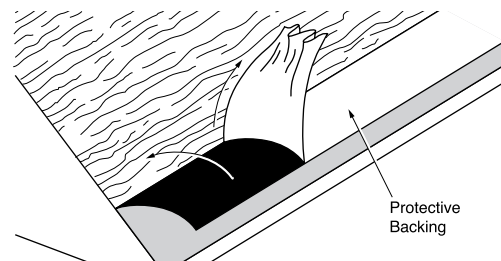

Figure 5-6: Application using the “Peel and Flop” Method.

You can apply WinterGuard with the “Peel and Flop” method, using the “two-piece, split-sheet, release-film” feature to adhere the longitudinal halves, one at a time. This feature allows one person to position the sheet before removing the protective plastic sheeting on the underside, then flop it back, peel off the release film, and set it, all without help. Press overlaps firmly into place with a hard roller. It is best to cut the product into manageable lengths of about 12' when applying WinterGuard by this method.

(3) THE “FLY-IN” APPLICATION METHOD

NOTE: This method requires two workers.

1. Cut WinterGuard to a convenient length and dry-fit the sheet to its proper location before removing the plastic release film.
2. Turn the entire sheet over and remove all the protective release film.
3. Pick up the sheet of WinterGuard from both ends and turn it over. Be careful that the wind doesn't catch the sheet when it's raised off the roof. In fact, don't even try this method on a windy day.

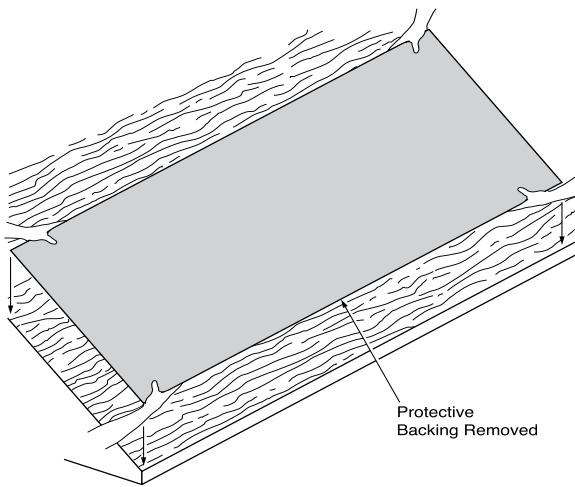

Figure 5-7: Application using the "Fly-In" Method.

4. Drop or "fly" the sheet into place, using great care to assure correct placement (Figure 5-7).
5. Press the sheet firmly against the deck to be sure of complete adhesion. It is recommended that you walk over WinterGuard to set it firmly to the deck.

APPLYING DRIP EDGE

1. Drip edge must be applied so that the higher pieces will overlap the lower pieces.
2. At the rake, drip edge may be installed under or over WinterGuard. When drip edge is installed over WinterGuard, the WinterGuard must cover the top of rake board.
3. At the eaves, if there is a chance of snow or ice build-up in the gutters, install drip edge over WinterGuard. WinterGuard must cover top of fascia board. In severe ice dam regions, WinterGuard can be wrapped over the fascia board and, if desired, onto the soffit. Cover all exposed WinterGuard with drip edge, gutter, wood or other weather-resistant material to protect it from damage. If there is no chance of snow or ice build-up in the gutters, install drip edge under the WinterGuard.

DEFEATING ICE BUILD-UP IN GUTTERS: Ice build-up in gutters will often allow meltwater to intrude behind fascia boards. Depending on construction of the eaves, deterioration of soffits or even interior damage can occur that looks like a roof leak. One method to solve this problem is shown in Figure 5-8. Another method is to wrap WinterGuard™ down the fascia onto the soffit, and nail a furring strip to hold WinterGuard tightly in place. This strip also serves as a UV block. Install the gutter in front of the WinterGuard-covered fascia. Then install the drip edge on the eaves over WinterGuard. Make sure the drip edge extends well into the rain gutter as shown in Figure 5-8, so UV rays are prevented from reaching WinterGuard. If the fascia is wider than about 6" WinterGuard must be stopped behind the gutter to prevent exposure to UV. This approach may not be compatible with vinyl fascia systems due to the chemical reaction which may cause the asphalt to bleed onto the vinyl.

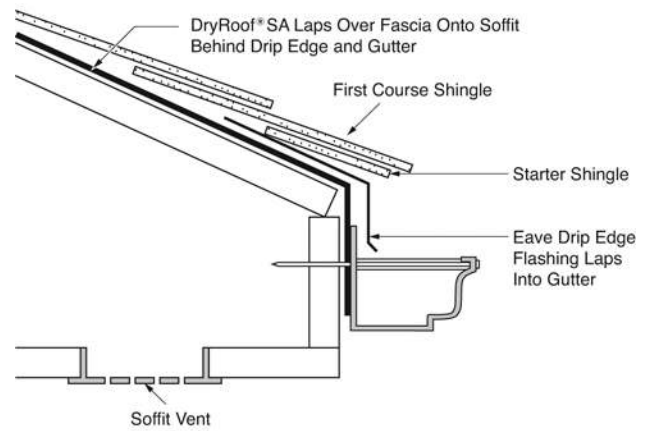

Figure 5-8: Application down the fascia to protect against ice build-up in gutters.

APPLYING WINTERGUARD ON VALLEYS

1. In valleys, the width of the material must be 36" minimum.
2. Apply WinterGuard using the "Peel and Flop" method described earlier. This time, however, be sure to use two workers to handle the sheet.
3. Be sure you're getting good adhesion down the valley centerline. WinterGuard must conform smoothly to the valley. If fasteners are required (because of cold weather or a steep slope), they must be no closer than 6" to the valley centerline.
4. In valleys, start the application at the low point and work upward.
5. To assure waterproofing, overlap all WinterGuard sheets 6" at lap joints. The uppermost portion must overlap the lower portion. A hard roller is recommended to roll and press WinterGuard in place at the laps.
6. Do not use WinterGuard as a permanent weathering surface in open valleys (or elsewhere).

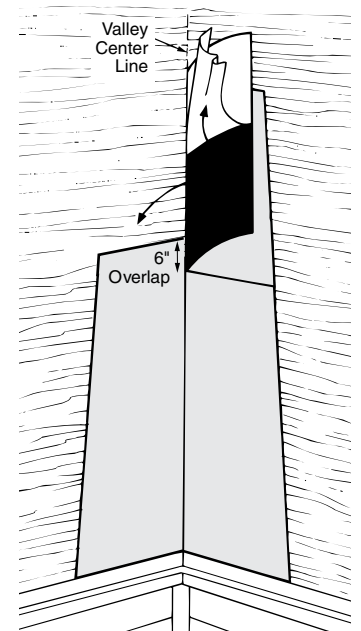

Figure 5-9: Valley application using the two-man "Peel and Flop" Method.

APPLYING WINTERGUARD ON LOW SLOPES

1. WinterGuard can be applied under shingles to provide protection against wind-driven rain water on low-slope applications.
2. The minimum approved slope for WinterGuard application is 2/12. If applied to cover the entire roof, ensure sufficient ventilation to avoid condensation.
3. It is especially important to assure adhesion at the laps by pressing all overlaps into place with a hard roller.

Note: WinterGuard HT can be applied under metal roofing on slopes of 0.5/12 (for all other types the minimum approved slope is 2/12).

SECTION 5 SELF-TEST

- 5-1. Typically, when installing water-resistant underlayment, side laps should be at least two inches and end laps at least six inches.
- A. True.
 - B. False.
- 5-2. Joint overlaps for DiamondDeck® and RoofRunner™ are different than felt and vary by roof slope.
- A. True.
 - B. False.
- 5-3. All shingles applied to a low slope deck require the use of WinterGuard® or its equivalent applied over the entire deck.
- A. True.
 - B. False.
- 5-4. At the eaves, if there's a chance of snow or ice buildup in the gutters, if possible, install WinterGuard under the drip edge.
- A. True.
 - B. False.
- 5-5. For ice dam protection, WinterGuard must be applied along the eaves and up the roof no less than 24" beyond the interior wall line.
- A. True.
 - B. False.

Test on-line @ www.certainteed.com/msatest.