

Trim Edge, Reveal Edge, Narrow Reveal Edge Installation Manual

Read entire manual before installing

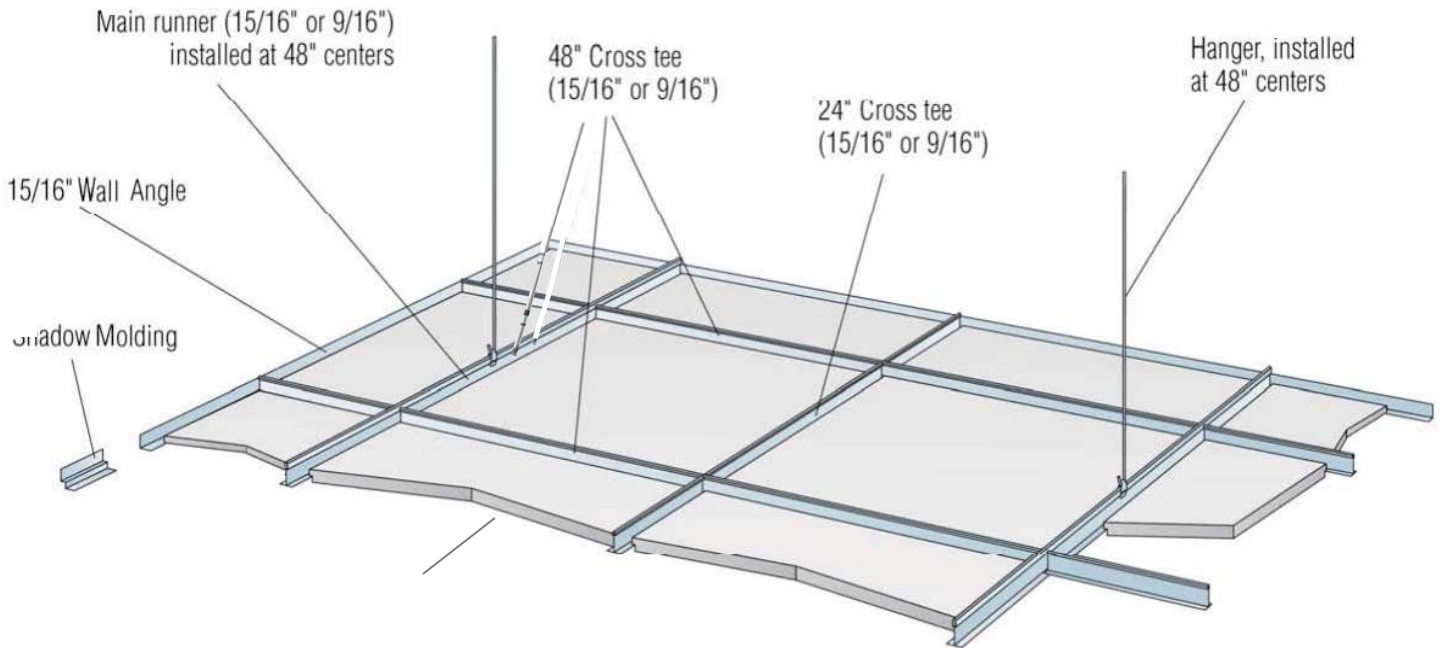

Components:

1. Trim Edge/Reveal Edge/Narrow Reveal Edge Panel
2. CertainTeed 15/16" Classic Main Runners (for Trim /Reveal Edge)
(or CertainTeed 9/16" Elite Narrow Main Runners for Narrow Reveal)
3. 15/16" Classic Cross Tees
(or 9/16" Elite Narrow Cross tees)
4. CertainTeed Ceilings 15/16" or 9/16" Wall Angle
(or Shadow Molding)
5. 2-ft Stabilizer Bar
(for modules \geq 5-ft in length)
6. 12-Gauge Hanger Wire

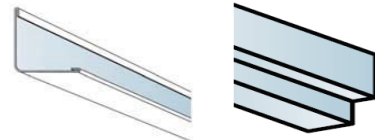
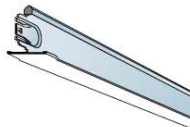
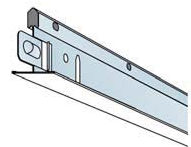

Always wear clean, white cotton gloves when handling panels.

Pre-Installation: Please read CertainTeed Ceiling's Pre-Installation Instructions before you begin these installation instructions.

1. Installing Wall Molding

- To install Wall Molding, choose a height at least three inches below joists, existing ceilings, ducts, pipes, or wiring, to ensure clearance and maneuverability required to install the panels.
- Mark the desired height for the finished surface of the ceiling on all four walls.
- Attach Wall Molding using appropriate fasteners.

2. Install Hangers

- Mark lines for each of the main runners.
- Pull a string line along the path that the first main runner will take. Attach the line directly below the wall molding.
- Hangers are placed every 48" along the main runners.

3. Install the First Main Runner

- Install the first section of main runner, with cut edge sitting on the wall angle.
- Attach the main runner to wire.

4. Install Border Cross Tees

- Establish the location of the first border cross tee.
- To cut the cross tee, place one end on top of the wall molding and against the wall, cut the cross tee directly at the mid point of the main runner (where it crosses the string line you set up).
- Spin the cut cross tee around and install the factory end into the main runner. Place the cut end of the cross tee on top of the wall molding.
- Clamp the cross tee where it sits on the wall molding, so that it does not fall or move.
- Repeat the process for the rest of the border tees.
- Install the remaining sections of Main Runner in the first line to reach the other wall. Be sure to check the level.
- Install the remaining cross tees.

5. Square the Grid System

- Install the first section of next main runner.
- Install two 4' cross tees in line with the border tees.
- Check to see if the system is square by measuring diagonally across the openings between the main runner and the cross tees. The measurements should be equal if the system is square.

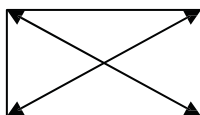

- Install 2' cross tees as needed.
- Repeat Steps 3-5 until the ceiling grid system is completed for the room

6. Install Panels
 - Put on white cotton gloves, so that the dirt and oil from your hands, does not get on the panels. (If gloves become soiled, replace them immediately.)
 - Start installing panels in the middle of the field.
 - Maneuver and tilt the panels above the grid, then carefully rest the panels on the grid.
7. Install Border Panels
 - Cut border panels by measuring each one individually. Use a straight edge to make perimeter cuts.
8. When installing panels in a 9/16" suspension system with modules \geq 5-ft in length, the insertion of a 2-ft stabilizer bars at or near the mid-point of the module is recommended.



If using Reveal Edge or Narrow Reveal Edge panels, note following three pages for options:

1. For a hand-rabbeted edge that finishes below the perimeter molding.
2. For a square-cut edge that finishes above the perimeter molding.

CertainTeed Ceilings Technical Services

20 Moores Road, Malvern, PA 19355 / 800-233-8990 / www.CertainTeed.com/ceilings

TECHNICAL CONCEPT

Subject:	Reveal edge treatments – not to scale
Date:	February 24, 2015
Tel:	800-233-8990

Shadow Molding application

Angle Molding application

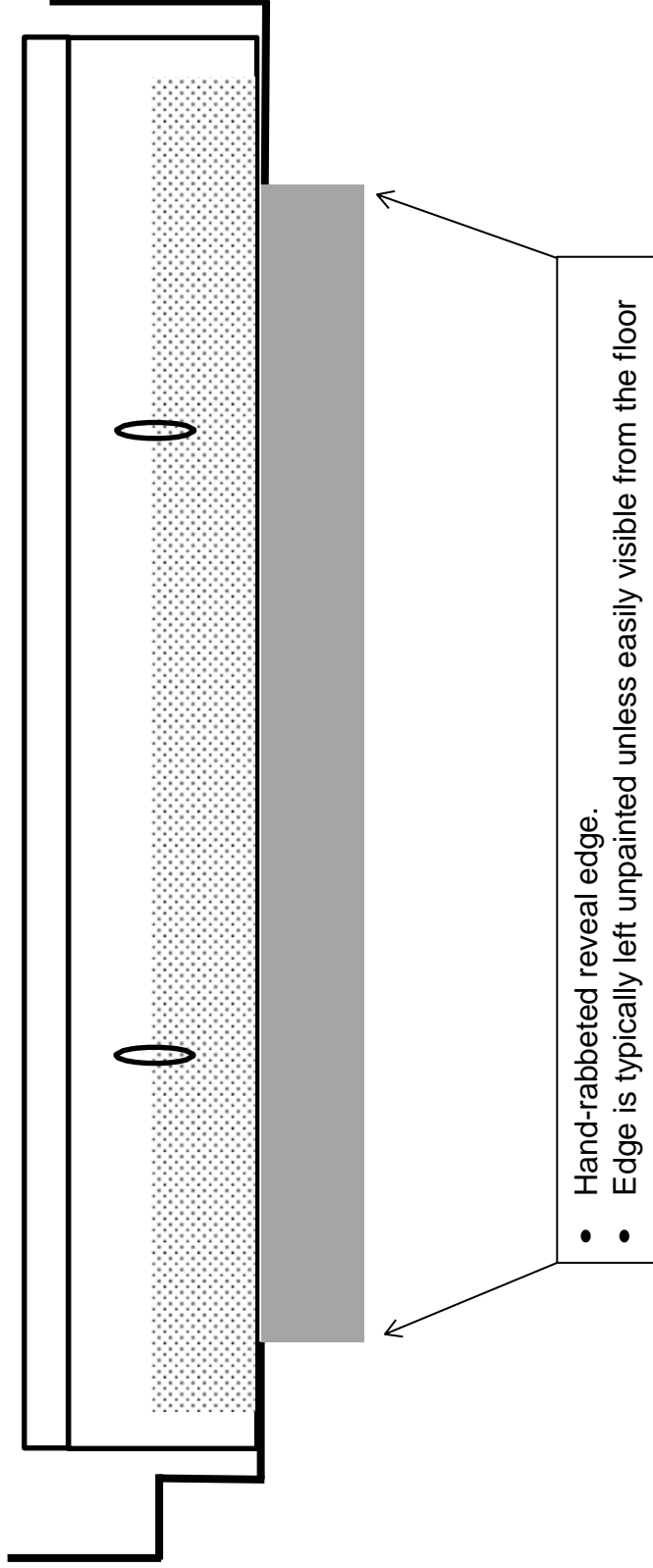

- Hand-rabbeted reveal edge.
- Edge is typically left unpainted unless easily visible from the floor

These drawings show typical conditions for installing the CertainTeed Ceilings product shown. They should not be construed as a substitute for an architectural or engineering design and don't reflect the unique requirements of local codes, laws, statutes or regulations that may be applicable for a specific installation. CertainTeed Ceilings assumes no liability for the accuracy or completeness of the drawings for a specific installation or the fitness of the drawings for a particular purpose. The user is advised to consult with local licensed design professionals in order to assure compliance with all legal requirements. CertainTeed Ceilings is not licensed to provide professional engineering or architectural services.

TECHNICAL CONCEPT

Subject:	Alternative reveal edge treatments – not to scale
Date:	February 24, 2015
Tel:	800-233-8990

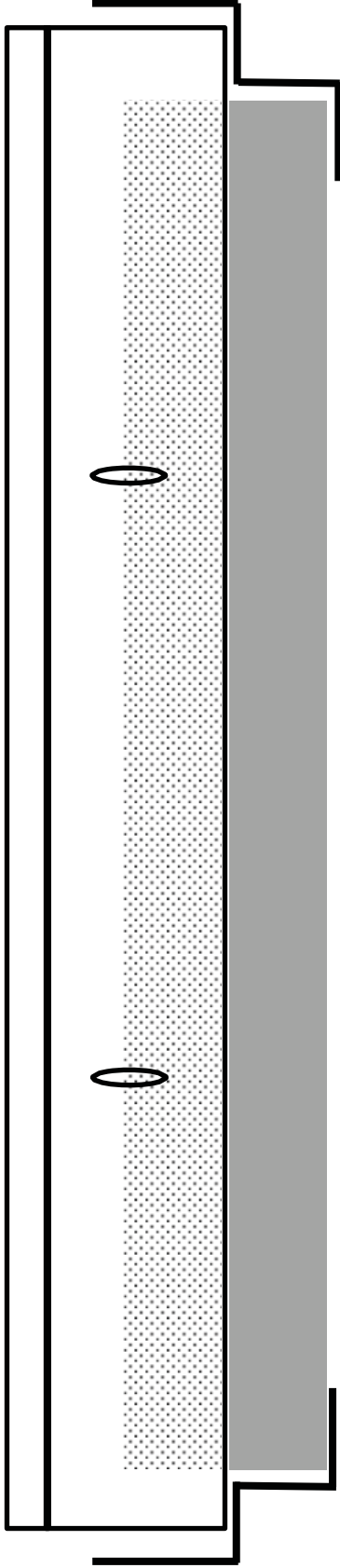

- Grid component resting on upper step of shadow molding
- Square-cut ceiling panel to fit snugly in the space

These drawings show typical conditions for installing the CertainTeed Ceilings product shown. They should not be construed as a substitute for an architectural or engineering design and don't reflect the unique requirements of local codes, laws, statutes or regulations that may be applicable for a specific installation. CertainTeed Ceilings assumes no liability for the accuracy or completeness of the drawings for a specific installation or the fitness of the drawings for a particular purpose. The user is advised to consult with local licensed design professionals in order to assure compliance with all legal requirements. CertainTeed Ceilings is not licensed to provide professional engineering or architectural services.

TECHNICAL CONCEPT

Subject:	Alternative reveal edge treatments – not to scale
Date:	February 24, 2015
Tel:	800-233-8990

Shadow Molding application

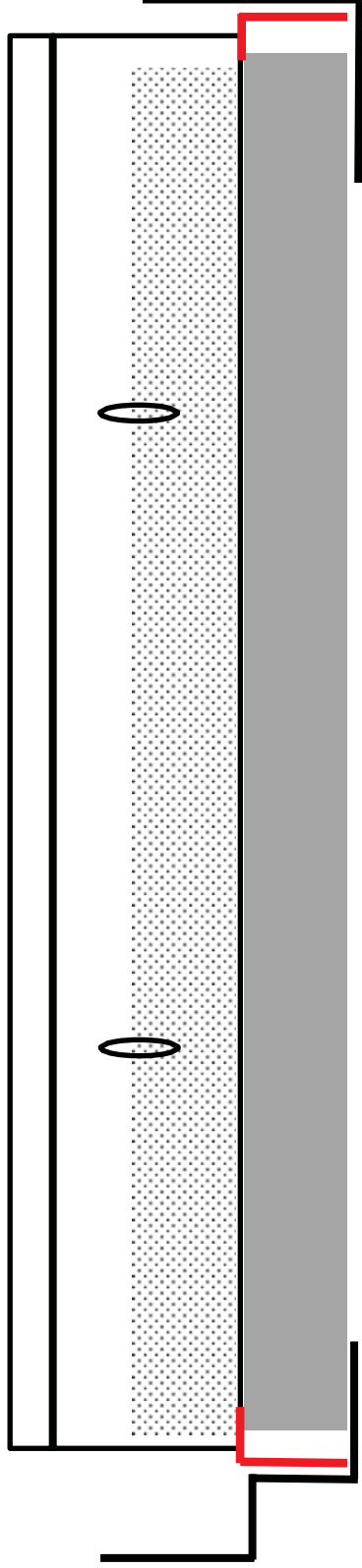

Angle Molding application

- Grid component resting on bent flange or shim
- Square-cut ceiling panel to fit snugly in the space

These drawings show typical conditions for installing the CertainTeed Ceilings product shown. They should not be construed as a substitute for an architectural or engineering design and don't reflect the unique requirements of local codes, laws, statutes or regulations that may be applicable for a specific installation. CertainTeed Ceilings assumes no liability for the accuracy or completeness of the drawings for a specific installation or the fitness of the drawings for a particular purpose. The user is advised to consult with local licensed design professionals in order to assure compliance with all legal requirements. CertainTeed Ceilings is not licensed to provide professional engineering or architectural services.