

GREEN GLUE

noiseproof your life



Product Information

Introducing Green Glue Noiseproofing Compound

Green Glue is a next-generation viscoelastic damping compound that can be used to soundproof floors, walls, or ceilings.

Green Glue was developed over hundreds of formulations specifically for use in typical field conditions. This has resulted in exceptional performance and consistency, allowing Green Glue to thrive in imperfect real-world conditions, and to routinely outperform more expensive factory damped panels.

Higher in performance and lower in cost than previous technologies, Green Glue is a step towards quieter living.

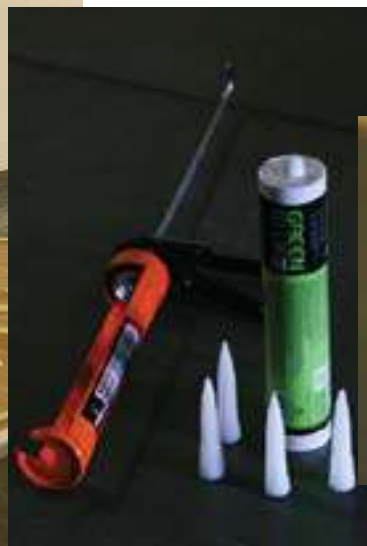

Real World Installation



Since Green Glue is not meant to be an adhesive, mechanical fasteners, such as screws, are required when using Green Glue. Green Glue is not affected by varying thickness in application and is designed to fit real world situations such as this.



Green Glue also works over variations in application pattern. Of the photos to the left, the looser, faster, less intricate pattern (top) actually tested better (very slightly better). Nearly any reasonable application pattern will work for you.

In the end, all this R&D and discussion boils down to results. At Giants Ridge Lodge in Biwabik, MN, Green Glue was used to repair some improperly installed resilient channel walls. In a laboratory simulation, an STC of 55 was achieved. In the field, an STC of 56 was reached. For comparison, in the same real world situation, exotic metal-containing factory damped “soundproof” drywall applied to both sides of the same wall delivered an STC of 48. In addition to better performance, Green Glue costs just a fraction of the competing product.





Installing Green Glue is Fast

No measuring or troweling

Use a standard (32oz) quart size caulk gun to apply.

Green Glue dispenses with very little effort.

Green Glue will not flow off the board during installation.

Application time is about 20-30 seconds per tube.

It is not necessary to have complete coverage to obtain excellent results.



Step 1

Hang the first layer of drywall - After hanging the first layer of drywall, it is recommended that you seal the seams between sheets. This can be done with either caulk or drywall mud. If using caulk, take care not to use a bead so large that it protrudes outside the plane of the drywall, preventing the second layer from sitting flat (below). If speed is an issue, you can omit this step and seal the perimeter after the last sheet of drywall is installed.

Step 2

Cut the Nozzle- Cut the end of the tube as shown to the right. Screw on separate nozzle and cut end leaving an opening of 3/8" or more .



Step 3

Applying Green Glue- Apply Green Glue to the second sheet of drywall on a clean flat surface. Placing the drywall on saw horses will help prevent the board from getting damaged or dirty from laying it on the floor. Apply the glue in large beads in a random pattern across the entire board. Leave a 2-3" border with no Green Glue around the edge of the board. This will allow you to carry the board without getting your hands in Green Glue and will have no detrimental affect on Green Glue's performance. Use 1 or 2 tubes per 4'x8' sheet. 1 tube gives about 70% of the benefit of 2 tubes.

Step 4

Hanging the Second Sheet- After applying the Green Glue to the back of the second layer, raise the board into position, press the board against the wall or ceiling, and fasten in place using appropriate screws. The Green Glue will squeeze into a thin layer (about 0.5 mm). The second layer with glue must be hung and screwed within 15 minutes to avoid the glue drying before its in place. Typical screw spacing is 16" oc for walls and 12" oc for ceilings, but be sure to follow all appropriate local building codes regarding screw type and spacing. Use a flexible latex caulk or an acoustical sealant to seal cracks and seams paying special attention to the crack where the drywall meets the floor as this doesn't get taped and mudded.



Green Glue Cleanup

Wet Green Glue cleans up easily with soap and water. Like most caulks and adhesives, Green Glue gets more difficult to clean off surfaces after it has dried. Use drop clothes or plastic to cover any surface you don't want Green Glue to get on and clean up any drips quickly. If you are attempting to clean dried Green Glue, allowing the area to soak in soap and water first will help. Since it remains sticky when dried, using a slippery liquid during clean up will prevent the glue from sticking again as you scrape it off. Drywall compound can be applied over dried Green Glue as long as the glue is fairly thin. Very thin films of dried Green Glue can also be painted over but it may cause cracking in the paint if the glue layer

DISCLAIMER: Because of the many installation variables beyond our control, Green Glue Company shall not be liable for incidental and consequential damages, directly or indirectly sustained, nor for any loss caused by application of these goods not in accordance with current printed instructions or for other than the intended use. Our liability is expressly limited to replacement of defective goods. Any claims shall be deemed as waived unless made in writing to Green Glue Company within thirty (30) days from the date it was discovered, or reasonably should have been discovered.

Green Glue Testimonials

Club Gemini, Bangor Maine



The owners of this Bangor nightclub had been the target of noise complaints for months. They were re-issued a special permit to stay in business, but only under the condition that they take steps to significantly increase the soundproofing. Three walls were concrete, but the fourth was a standard single stud wall. It was recommended to remove the old wood wall and replace it with a double stud wall. On the inside they used three layers of standard 5/8" drywall with Green Glue. On the outside they used three sheets of standard "T-111" exterior siding with 3.5" fiberglass insulation in the stud cavities.

COMMENTS FROM THE MANAGEMENT: "The sound problem has been completely eliminated. We hosted the City Council to demonstrate the effectiveness of the new wall. We really turned up the volume to give the council an idea of the sound levels inside during operation. Then everyone went out into the parking lot. There is a 'wow' factor as everyone comes out."

Council member Gerry Palmer noted. "The sound from the mercury vapor lights was louder than what was coming out of the building when standing 15 feet away."

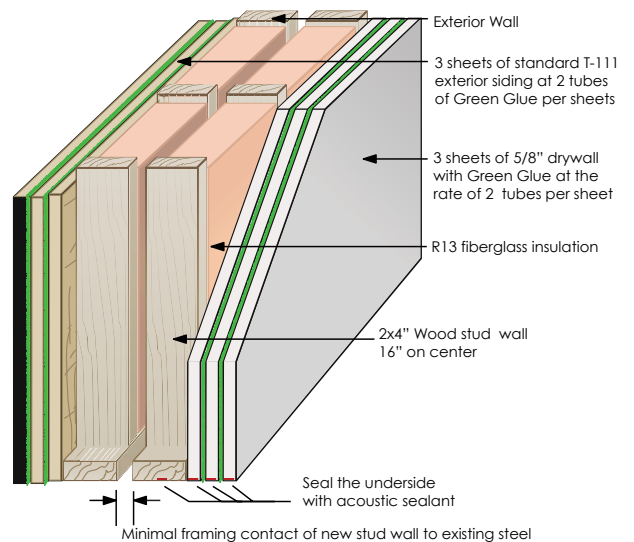

Comfort Inn, Aurora Colorado

The motel was scheduled for a remodel. One of the issues scheduled for upgrading was the sound isolation between units. Previously there was a single stud wall with single 5/8" drywall on each side. There were frequent customer noise complaints about occupants in adjacent rooms. After considering many options including pre-fabricated "soundproof" drywall, Green Glue was selected to be used. An additional layer of 5/8" drywall with Green Glue was installed. All seams and outlets were sealed with caulk.

COMMENTS FROM THE CONSTRUCTION FIRM: "Cost, performance, and speed of installation were the three driving factors considered. On a test wall, Green Glue passed the motel owner's informal sound tests even before it was completely dry. When we first started this research (for sound isolation) we were concerned about finding a solution that was fast and required no special skill or training. After the furniture was moved, we could complete the drywall install (with Green Glue), sealing with caulk and first coat of mud in under 1 hour. We were able to conduct the remodel while the motel was still occupied."

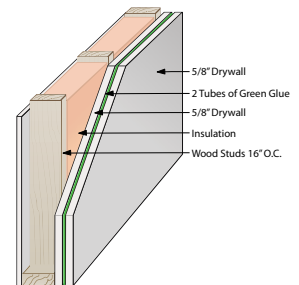

Green Glue Testimonials

Esquire Townhouses, Okemos MI

This is the latest phase of the town home project. This is all new construction. Previously units were constructed with resilient channel and double drywall on the walls and ceilings. There were issues with short circuiting the resilient channel as well as crushing the resilient channel on the walls after an impact. In the 900 building, the resilient channel was replaced with Green Glue between the double drywall.

COMMENTS FROM THE MANAGEMENT:

"We found the Green Glue easier to work with than the resilient channel. Once the Green Glue dried, the rooms were really quiet. The walls feel more solid also. We have Green Glue spec'd for the next building this summer."

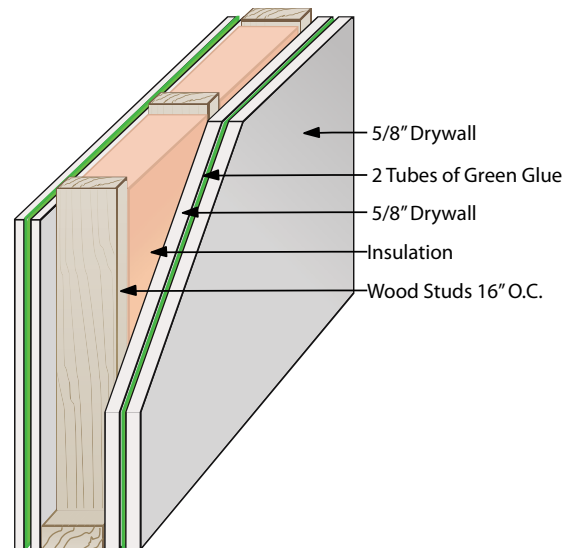

Rives Audio

We (Rives Audio) are in the completion stages of a high-end Home Theater, in the Chicago area. We specified Green Glue for the first time on this project, having used soundboard (Celotex or an equivalent) before. In fact, I have been using 1/2" soundboard as a 'change of medium' between two layers of 5/8" sheetrock in my studio design work for 25 or more years.

I have just returned from a site visit to the Chicago project and had a chance to evaluate the preliminary results. I have to say that the Green Glue product is exceptional as a damping factor. It reduces the ability of the sheetrock to vibrate at its fundamental frequencies (relative to spacing and attachment) with great efficiency, so much so that we intend to specify Green Glue for all our future work.



Chris Huston / Vice President, Acoustical Engineer



74 Kent Street
Brooklyn, New York 11222-1517

Phone (718) 383-5080
Fax (718) 383-7445
E-mail: dllabs@aol.com

Accredited by National Voluntary Laboratory Accreditation Program - Lab Code 100252
ISO / IEC 17025 and relevant requirements of ISO 9002

January 6, 2006

Audio Alloy LLC
Midland, MI

Att: Mr. Brian Ravnaas

Re: DL-14710A

OBJECTIVE

To determine the water vapor transmission properties of drywall sheeting when bonded with adhesive.

PRODUCTS TESTED

Bonded drywall panels were submitted by Audio Alloy LLC. The drywall assemblies were identified as follows:

Panels "**Marked 1**" were produced by troweling a layer of "**Green Glue**" onto the drywall with a 1/8-inch V-notch trowel. The drywall layers were then compressed to produce a nearly uniform thin film of adhesive between the drywall panels.

Panels "**Marked 2**" were produced by applying "**Green Glue**" onto the drywall in the recommended application pattern from an adhesive cartridge. The drywall layers were then compressed, but the adhesive film does not cover 100% of the surface area.

In addition, drywall panels were included for evaluation with out the adhesive film layer. The **Control** drywall panels consisted of a one or single drywall layer and two or double drywall layer assembly.

PROCEDURE

Testing was conducted in accordance with procedures outlined in ASTM Method E 96, "Water Vapor Transmission of Materials", Procedure A, (Desiccant Method).



TEST RESULTS

The water vapor transmission properties of the bonded and not bonded drywall assemblies are indicated below:

	<u>WVT</u> (grains / sq. ft. / hr.)	<u>WVP</u> (perms)
<i>Panels Marked 2</i> Green Glue, recommended cartridge application	1.3	3.1
<i>Control one drywall layer</i>	4.5	10.4
<i>Control two drywall layers</i>	3.3	7.6

WVT – Water Vapor Transmission Rate
WVP – Water Vapor Permeance



CLIENT: GREEN GLUE COMPANY
710 11th Avenue North East
West Fargo, ND 58078
Brent Ravnaas

Test Report No: 914.010361

Date: February 12, 2008

SAMPLE ID: The Client submitted and identified the following test material as Green Glue applied to cement board at a coverage rate of 65 sq ft / gal. See preparation details on page 2

DATE OF RECEIPT: Entered into SGS USTC sample tracking system on March 16, 2007.

TESTING PERIOD: April 11, 2007.

AUTHORIZATION: Testing authorized by Brent Ravnaas

TEST REQUESTED: Perform standard flame spread and smoke density developed classification tests on the sample supplied by the Client in accordance with ASTM Designation E84-07, "Standard Method of Test for Surface Burning Characteristics of Building Materials". The foregoing test procedure is comparable to UL 723, ANS/ NFPA No. 255, and UBC No. 8-1.

TEST RESULTS:	<u>Flame Spread</u>	<u>Smoke Density</u>
	15	50

For detailed results see page 2.

Tested by

Brian Ortega
Test Technician

**Signed for and on behalf of
SGS U.S. Testing Company Inc.**

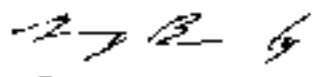
Greg Banasky
Supervisor Fire Technology

Page 1 of 2

This report is issued by SGS U.S. Testing Company Inc. under its General Conditions for Testing Services (copy available on request). SGS U.S. Testing's responsibility under this report is limited to proven negligence and will in no case be more than the amount of the testing fees. Except by special arrangement, samples are not retained by SGS U.S. Testing for more than 30 days. The results shown on this test report refer only to the sample(s) tested unless otherwise stated, under the conditions agreed upon. Anyone relying on this report should understand all of the details of the engagement. Neither the name, logo, marks nor insignia of SGS U.S. Testing may be used in any advertising or promotional materials without the prior written approval of SGS U.S. Testing. The test report cannot be reproduced, except in full, without prior written permission of SGS U.S. Testing Company Inc.



Report No.: 914-010361
Date: February 12, 2008
Page: 2 of 2

CLIENT: GREEN GLUE COMPANY

PREPARATION: The sample material was applied to three pieces 22" wide by 96" long, of 1/4" cement board with a 1/8" V-notched trowel at a coverage rate of 65 sq ft./gal. The resulting ridges were flattened out to simulate being compressed between two layers of building material.

E 84 TEST DATA SHEET:

CLIENT: Green Glue Company DATE: 04/11/07

SAMPLE: Green glue applied to cement board at a coverage rate of 65 sq ft./gal

FLAME SPREAD:

IGNITION: 1 minute, 30 seconds

FLAME FRONT: 4.5 feet maximum

TIME TO MAXIMUM SPREAD: 4 minutes, 50 seconds

TEST DURATION: 10 minutes

CALCULATION: 32.04 x 0.515 = 16.50

SUMMARY: FLAME SPREAD: 15 SMOKE DENSITY: 50

SUMMARY OF ASTM E84 RESULTS: Because of the possible variations in reproducibility, the results are adjusted to the nearest figure divisible by 5. Smoke Density values over 200 are rounded to the nearest figure divisible by 50.

In order to obtain the Flame Spread Classification, the above results should be compared to the following table.

<u>NFPA CLASS</u>	<u>UBC CLASS</u>	<u>FLAME SPREAD</u>	<u>SMOKE DENSITY</u>
A	I	0 through 25	Less than or equal to 450
B	II	26 through 75	Less than or equal to 450
C	III	76 through 200	Less than or equal to 450

BUILDING CODES CITED:

1. National Fire Protection Association, ANSI/NFPA No. 101, "Life Safety Code", 1994 Edition.
2. Uniform Building Code, 1994 Edition, Chapter 8, Interior Finishes Sections 801-807

End of Report



Report Prepared For:

Audio Alloy, LLC

Attn: Brent Ravnaas

2241 Great Northern Dr.

Fargo, ND 58102

Report Date: 03/31/2006

Report ID#: N0635859

PROJECT: SAMPLE TESTED IN TRIPLICATE

COLLECTED BY: BRENT RAVNAAS

DATE COLLECTED: 02/28/2006, DATE RECEIVED: 03/01/2006

ANALYSIS: COATING RESISTANCE TO MOLD GROWTH (Method: ASTM D-3273-00)

RESULTS @ (28 Days)

Note: 0 = No Resistance; 10 = Complete Resistance

SAMPLE RATING: @ 7 Days

<u>Sample ID:</u>	<i>Result</i>	<i>Initial</i>	<i>Units</i>	<i>Final</i>	<i>nits</i>	<i>Weight</i>	<i>Units</i>
•Green Glue	10	197.8	grams	210.7	grams	12.9	grams

COMMENTS:

- Results are based on samples submitted to Northeast Laboratories, Inc. on: 03/01/2006.
- Samples will be held for (5) days, then disposed of accordingly.

Approved By:

William W. Ullmann, Ph.D.

President & Technical Director

Effect of Green Glue in a wood stud wall

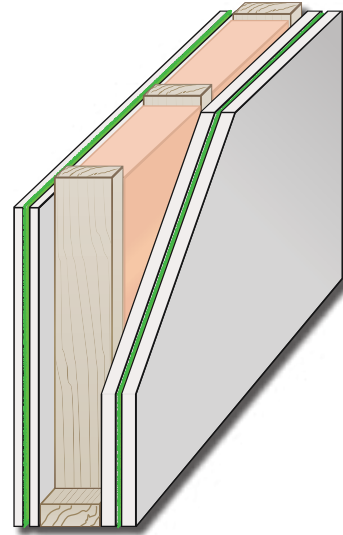
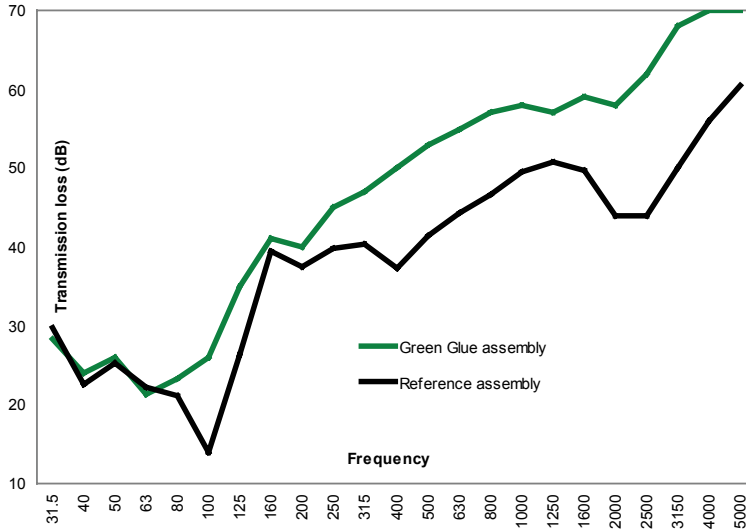

Type	Test number	STC	OITC	Rw	Rw+Ctr
Reference	OL 06 0607	45	30	44	33
Green Glue	OL 05 1049	55	39	54	44



Green Glue transforms the sound isolation of common wood stud walls from poor to excellent. For walls of the same weight in this comparison, Green Glue adds 10 STC points and improves low frequency performance by as much as 12 dB.

Layer 1

Reference

5/8" drywall
5/8" drywall

Green Glue

5/8" drywall
Green Glue
5/8" drywall

Framework

2x4 wood studs 24" OC
3.5" fiberglass insulation

Layer 2

5/8" drywall
5/8" drywall

5/8" drywall
Green Glue
5/8" drywall

Effect of Green Glue in a staggered stud wall

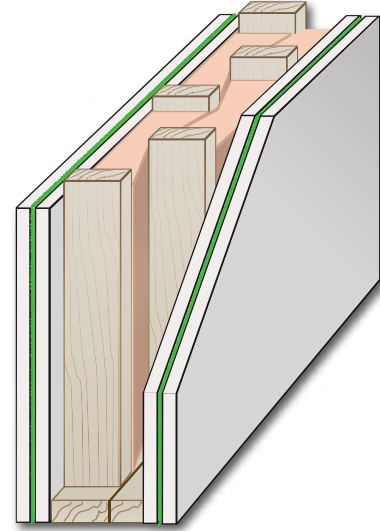
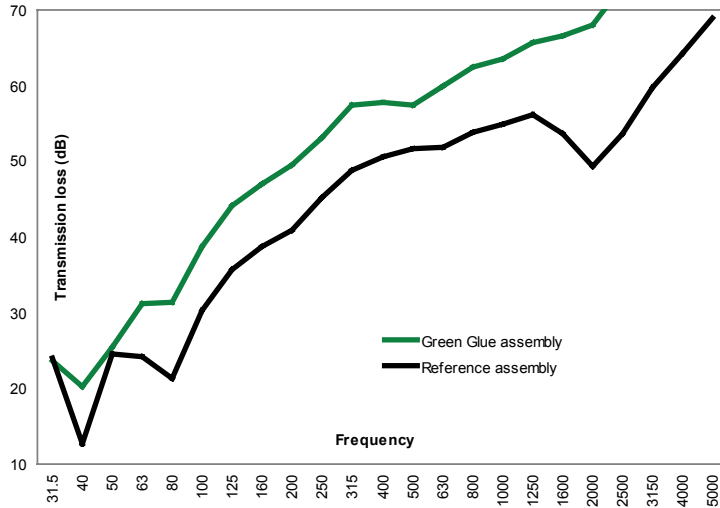

Type	Test number	STC	OITC	Rw	Rw+Ctr
Reference	OL 06 0635	53	39	53	47
Green Glue	OL 07 0530	62	49	62	55

Green Glue works on normally high performance walls such as staggered stud walls as well. For walls of the same weight in this comparison, Green Glue adds 9 STC points and improves low frequency performance by as much as 10 dB.

	Reference	Green Glue
Layer 1	5/8" drywall 5/8" drywall	5/8" drywall Green Glue 5/8" drywall
Framework	2x4 staggered wood studs 16" OC 3.5" fiberglass insulation	
Layer 2	5/8" drywall 5/8" drywall	5/8" drywall Green Glue 5/8" drywall

Effect of Green Glue on poorly installed Resilient Channel

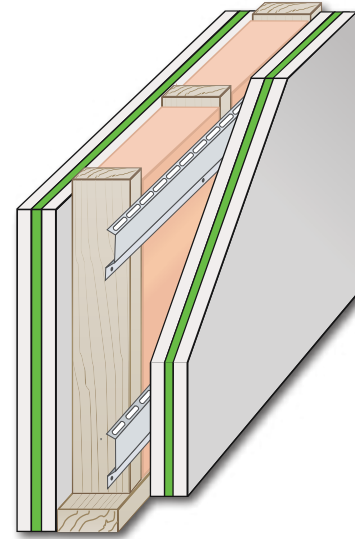
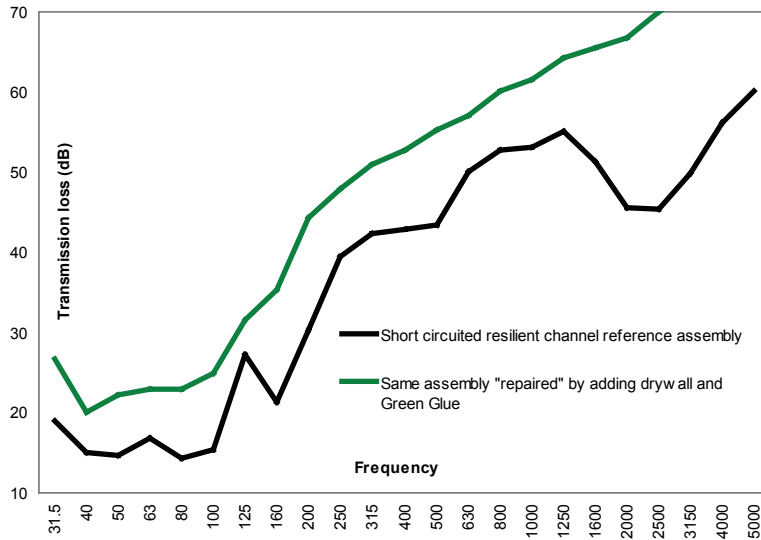

Type	Test number	STC	OITC	Rw	Rw+Ctr
Reference	OL 07 0205	42	29	44	33
Green Glue	OL 07 0215	56	38	55	43

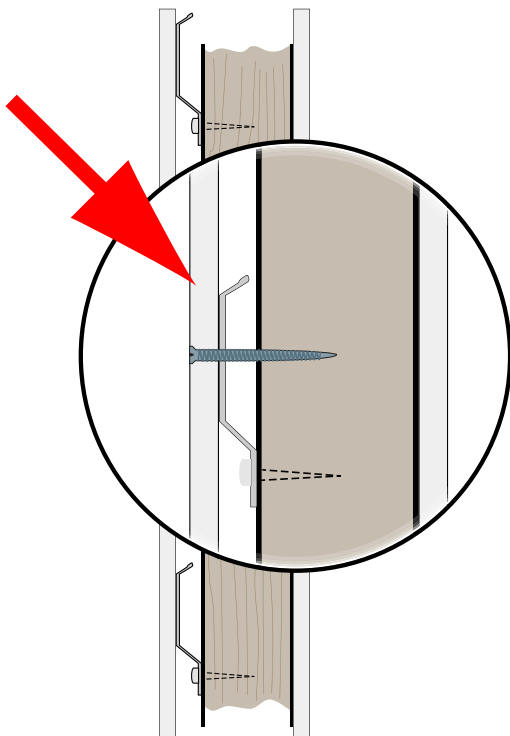

Walls built with resilient channel are frequently installed incorrectly - screws penetrate into studs and eliminate the flexibility of the resilient channel creating short circuits. Adding Green Glue and drywall to such walls dramatically restores the performance of these walls, allowing poor-performing resilient channel walls to be "repaired" in the field without expensive re-construction.

	Reference (short circuits)	Green Glue
Layer 1	5/8" drywall 5/8" drywall	5/8" drywall Green Glue 5/8" drywall
Framework	2x6 wood studs 16" OC w/ resilient channel 24" OC 3.5" fiberglass insulation	
Layer 2	5/8" drywall 5/8" drywall	5/8" drywall Green Glue 5/8" drywall

Effect of Green Glue in floors - field test

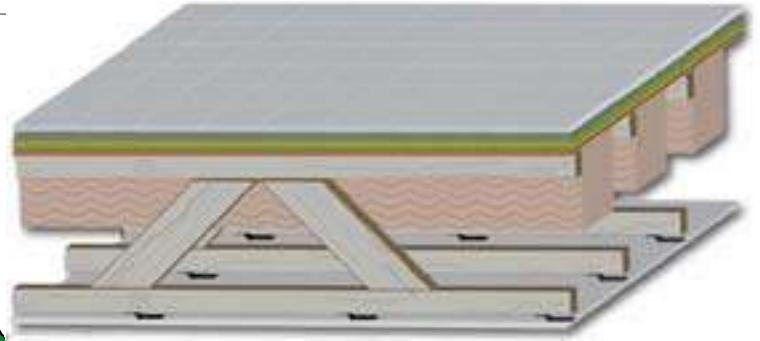
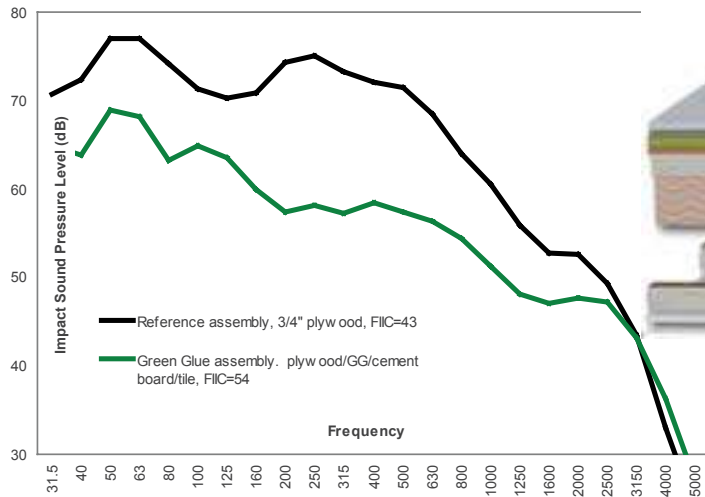

Type	FIIC
Reference assembly	43
Green Glue	54

Hard surfaces like hardwood and tile often result in excessive noise from footsteps and other impacts on the floor. This field test shows how effective Green Glue can be at reducing those. Even with the harder tile surface, results are substantially better.

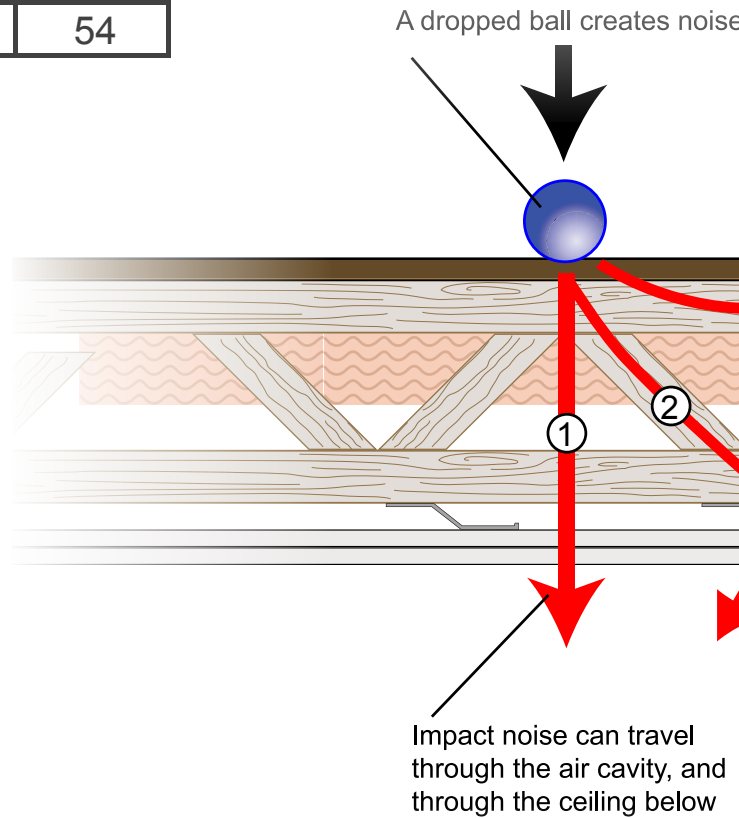

	Reference	Green Glue
Layer 1	3/4" Plywood	tile 1/2" cement board Green Glue 3/4" Plywood
Framework	Joists R19 insulation	
Layer 2	Resilient Channel 5/8" Drywall	Resilient Channel 5/8" Drywall

Effect of Green Glue in floors - lab test

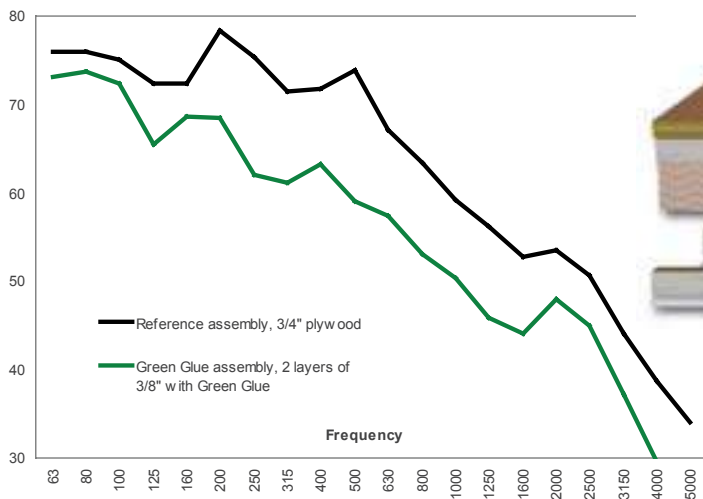

Type	Test number	STC	IIC
Reference assembly	OL 07 0501	51	41
Green Glue	OL 07 0511	57	48

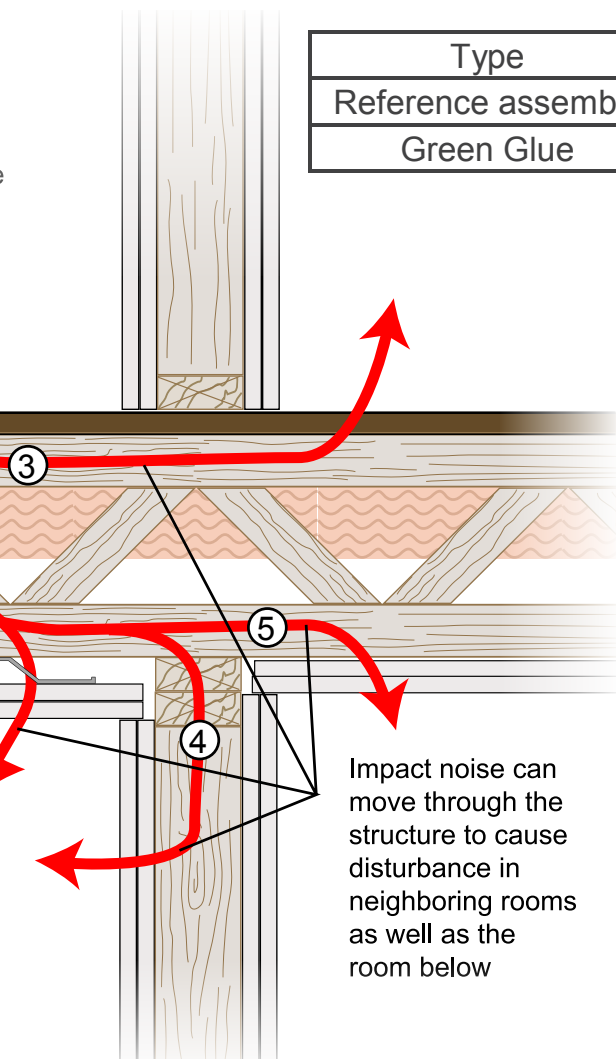

Green Glue in a floor results in large reductions in footstep and other impact noise. Used just in the floor, with no changes to joists, insulation or ceiling, Green Glue reduces impact noise by an average of 8.5 dB. IIC improves 7, STC improves 6.

	Reference	Green Glue
Layer 1	3/4" Plywood	3/8" Plywood Green Glue 3/8" Plywood
Framework	Joists R19 insulation	
Layer 2	Resilient Channel 5/8" Drywall	Resilient Channel 5/8" Drywall

Effect of Green Glue in a steel stud wall

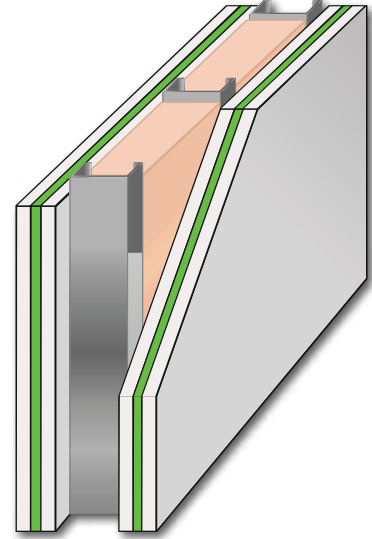
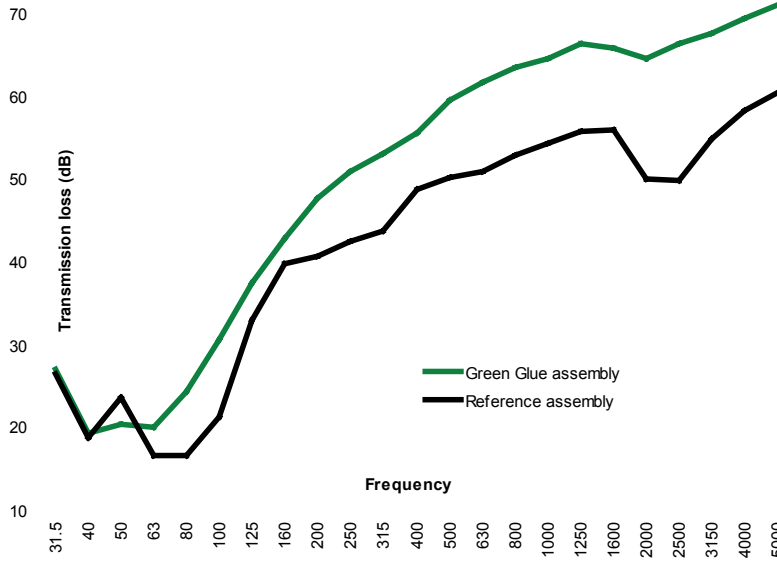

Type	Test number	STC	OITC	Rw	Rw+Ctr
Reference	OL 06 0634	52	34	51	40
Green Glue	OL 06 0942	61	42	60	49



Green Glue improves the performance of metal stud walls considerably. For walls of the same weight in this comparison, Green Glue adds 9 STC points and improves low frequency performance as well.

	Reference	Green Glue
Layer 1	5/8" drywall 5/8" drywall	5/8" drywall Green Glue 5/8" drywall
Framework	3.5" 25 gauge steel studs 24" OC 3.5" fiberglass insulation	
Layer 2	5/8" drywall 5/8" drywall	5/8" drywall Green Glue 5/8" drywall

Green Glue vs Factory Damped Drywall - Resilient Channel

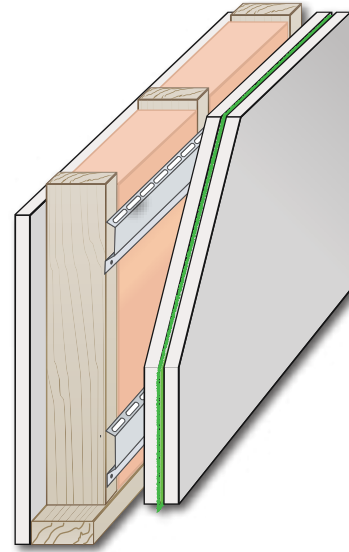
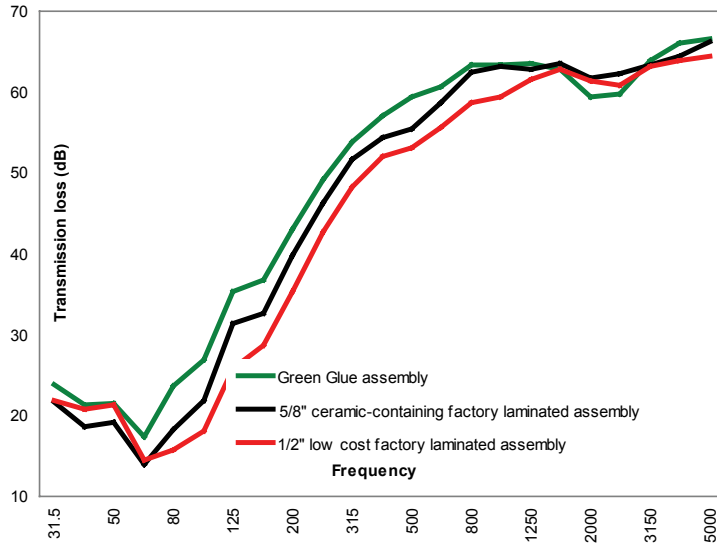

Type	Test number	STC	OITC	Rw	Rw+Ctr
Low cost 1/2" factory-damped "soundproof" drywall	OL 08 0518	50	32	49	37
5/8" factory damped "soundproof" drywall with a ceramic layer	OL 08 0604	54	35	53	41
Green Glue	OL 08 0520	58	40	57	45

Green Glue easily outperforms these 2 types of factory-damped drywall, especially at low frequencies. The higher weight of a Green Glue assembly (2 layers of conventional drywall + Green Glue) relative to a thin factory-laminated panel and the superb performance of Green Glue itself deliver better results.

	FDD1	FDD2	Green Glue
Layer 1	5/8" factory laminated "soundproof" drywall with metal inner layer	1/2" factory-damped drywall	5/8" Drywall Green Glue 5/8" Drywall
Framework	2x4 wood studs, 16" OC Deitrich RC Deluxe, 24" OC R13 fiberglass insulation		
Layer 2	5/8" Drywall	5/8" Drywall	5/8" Drywall

Green Glue vs Competitive Damping Glues

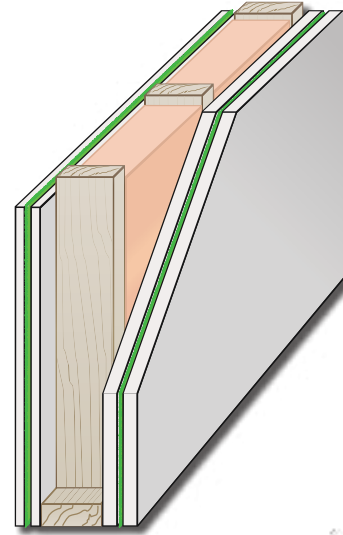
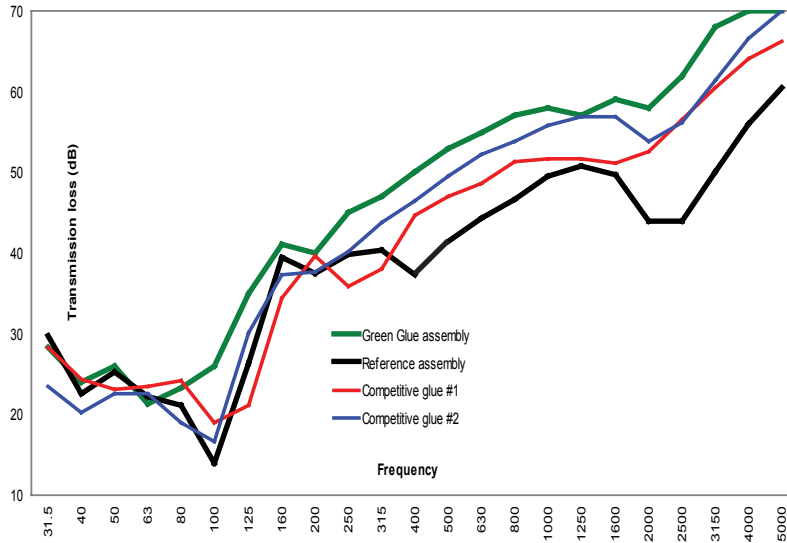

Type	Test number	STC	OITC	Rw	Rw+Ctr
Reference	OL 06 0607	45	30	44	33
Competition 1	OL 06 0940	45	33	47	36
Competition 2	OL 07 0807	52	32	50	36
Green Glue	OL 05 1049	55	39	54	44

We know of no competitive product that performs as well as Green Glue, although there are some that claim to. Two comparisons are shown here - same frame, same weight of drywall, same application of damping material - but both fall well short of Green Glue's performance, especially at lower frequencies.

	Reference	Green Glue	Competitor 1	Competitor 2
Layer 1	5/8" Drywall 5/8" Drywall	5/8" Drywall Green Glue 5/8" Drywall	5/8" Drywall Competitive Material 5/8" Drywall	5/8" Drywall Competitive Material 5/8" Drywall
Framework	2x4 wood studs, 24" OC R13 fiberglass insulation			
Layer 2	5/8" Drywall 5/8" Drywall	5/8" Drywall Green Glue 5/8" Drywall	5/8" Drywall Competitive Material 5/8" Drywall	5/8" Drywall Competitive Material 5/8" Drywall

Green Glue vs Factory Damped Drywall - Wood Studs

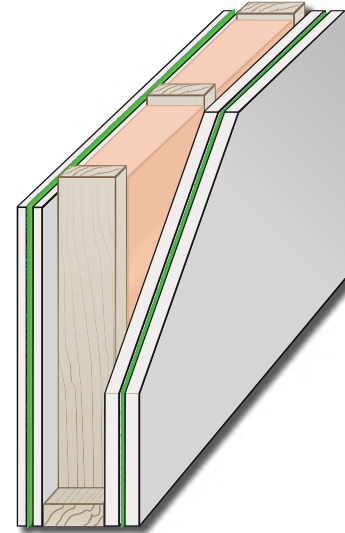
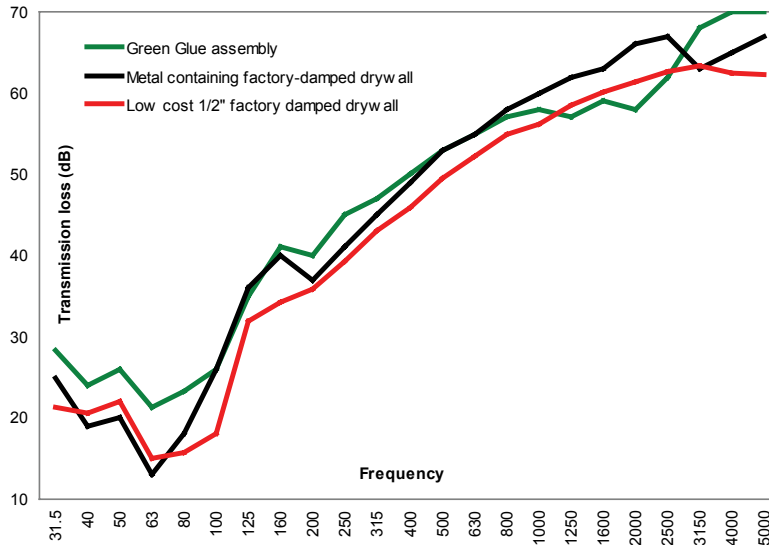

Type	Test number	STC	OITC	Rw	Rw+Ctr
Factory damped drywall, containing metal and 2 damping layers	OL 05 0820	54	36	53	44
Low cost 1/2" factory damped "soundproof" drywall	OL 08 0509	51	32	49	37
Green Glue	OL 05 1049	55	39	54	44

Green Glue outperforms all thin factory-laminated "soundproof" drywall products. Even exotic ones with metal and more than one layer of damping material. The secret to Green Glue's superior performance is simple. A Green Glue wall, with 2 layers of normal, low-cost drywall, weighs more. And a Green Glue field application gives a wall with much more viscoelastic material than is contained in factory-laminated panels (which tend to have a very thin layer). Lastly, Green Glue is higher in performance than any other damping material of its type, anywhere in the world, that we are aware of. These advantages are particularly evident at lower frequencies, where Green Glue is up to 8dB better than the factory-damped product on the same assembly.

	FDD1	FDD2	Green Glue
Layer 1	5/8" factory laminated "soundproof" drywall with metal inner layer	1/2" factory-damped drywall	5/8" Drywall Green Glue 5/8" Drywall
Framework	2x4 wood studs, 24" OC R13 fiberglass insulation		
Layer 2	5/8" factory laminated "soundproof" drywall with metal inner layer	1/2" factory-damped drywall	5/8" Drywall Green Glue 5/8" Drywall

Green Glue vs Conventional Adhesives

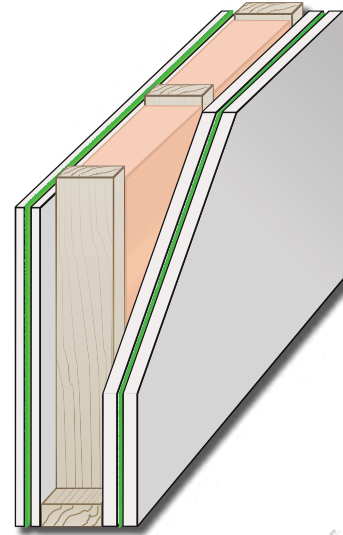
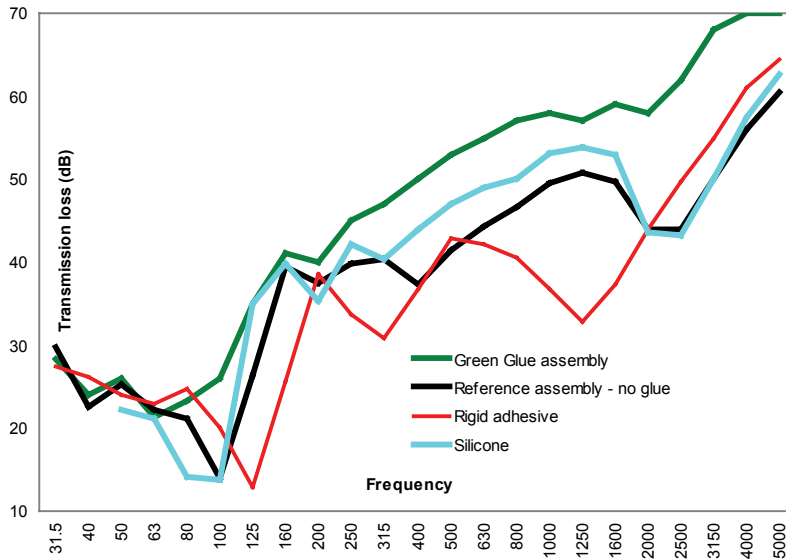

Type	Test number	STC	OITC	Rw	Rw+Ctr
Reference, no glue	OL 06 0607	45	30	44	33
Construction adhesive	OL 06 0912	37	27	38	31
Silicone	OL 07 0817	47	29	46	33
Green Glue	OL 06 0942	55	39	54	44

Green Glue's performance is superior to all conventional off-the-shelf materials. Rigid adhesives lower performance by stiffening the wall. Common flexible adhesives, like silicone sealant, do not lower performance but contribute very little and tend to be fairly expensive. Green Glue has a dramatic positive effect on wall performance and is both more effective and more cost-effective than any off the shelf material.

	Reference	Green Glue	Construction Adhesive	Silicone
Layer 1	5/8" Drywall 5/8" Drywall	5/8" Drywall Green Glue 5/8" Drywall	5/8" Drywall Construction Adhesive 5/8" Drywall	5/8" Drywall Silicone 5/8" Drywall
Framework	2x4 wood studs, 24" OC R13 fiberglass insulation			
Layer 2	5/8" Drywall 5/8" Drywall	5/8" Drywall Green Glue 5/8" Drywall	5/8" Drywall Construction Adhesive 5/8" Drywall	5/8" Drywall Silicone 5/8" Drywall

Green Glue vs Soundboard

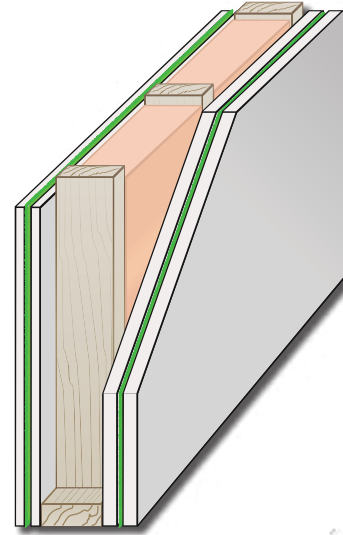
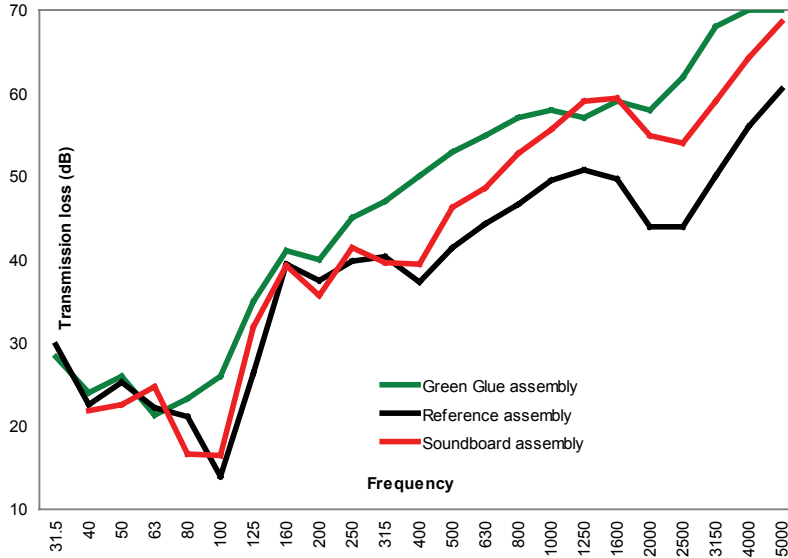

Type	Test number	STC	OITC	Rw	Rw+Ctr
Reference	OL 06 0607	45	30	44	33
Soundboard	OL 07 0812	49	31	48	36
Green Glue	OL 05 1049	55	39	54	44



Using soundboard in a 2x4 delivers excellent high frequency performance, but only slight gains at lower frequencies. As a result, Green Glue substantially outperforms soundboard.

	Reference	Soundboard	Green Glue
Layer 1	5/8" Drywall 5/8" Drywall	5/8" Drywall Soundboard 5/8" Drywall	5/8" Drywall Green Glue 5/8" Drywall
Framework	2x4 wood studs, 24" OC R13 fiberglass insulation		
Layer 2	5/8" Drywall 5/8" Drywall	5/8" Drywall Soundboard 5/8" Drywall	5/8" Drywall Green Glue 5/8" Drywall

Green Glue vs Factory Damped Drywall - Steel Studs

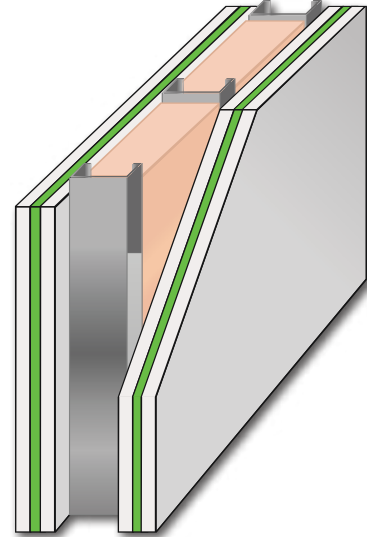
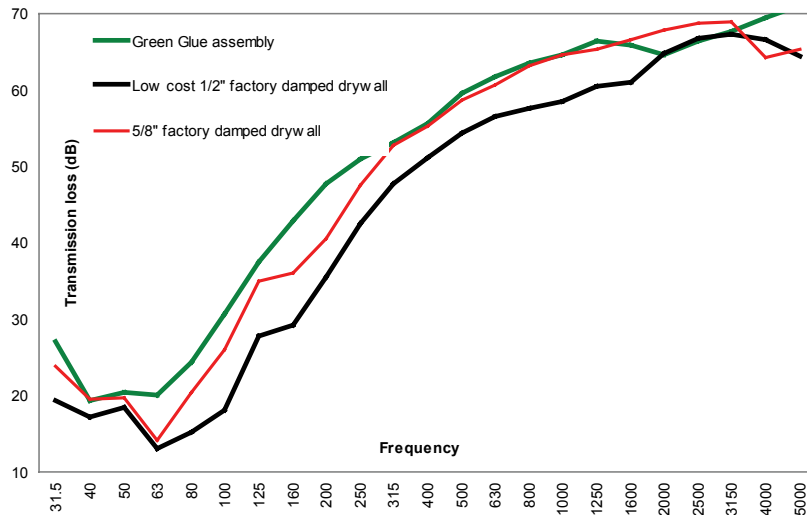

Type	Test number	STC	OITC	Rw	Rw+Ctr
Low cost 1/2" factory-damped "soundproof" drywall	OL 08 0626	50	31	50	37
5/8" factory damped "soundproof" drywall	OL 08 0625	57	38	56	44
Green Glue	OL 06 0942	61	42	60	49

Green Glue easily outperforms these 2 types of factory-damped drywall, especially at low frequencies. The thinner laminated products weigh less than an assembly of 2 layers of normal drywall with Green Glue. This extra weight combined with Green Glue's excellent damping performance account for the difference.

	Green Glue	FDD-1	FDD-2
Layer 1	5/8" drywall Green Glue 5/8" drywall	5/8" factory laminated "soundproof" drywall	1/2" factory-damped drywall
Framework	3.5" 25 gauge steel studs 24" OC 3.5" fiberglass insulation		
Layer 2	5/8" drywall Green Glue 5/8" drywall	5/8" factory laminated "soundproof" drywall	1/2" factory-damped drywall

Green Glue vs Mass Loaded Vinyl

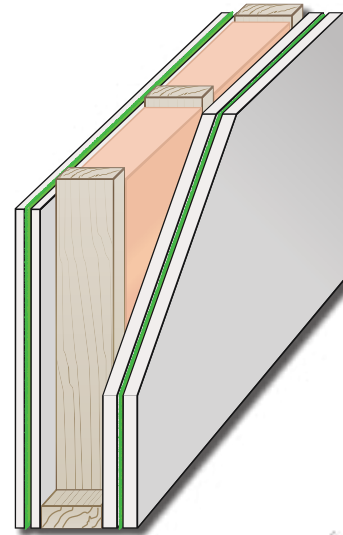
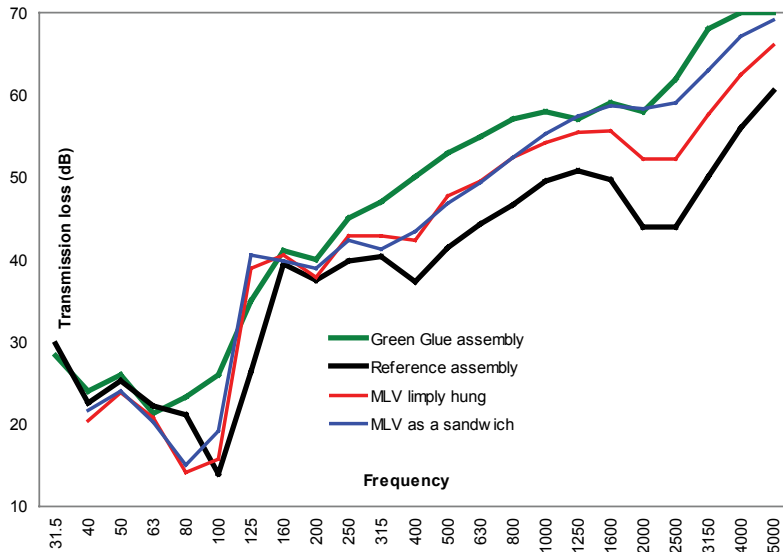

Type	Test number	STC	OITC	Rw	Rw+Ctr
Reference	OL 06 0607	45	30	44	33
MLV in sandwich	OL 07 0820	52	32	50	39
MLV limply hung	OL 07 0819	51	30	49	35
Green Glue	OL 05 1049	55	39	54	44

Mass loaded vinyl can improve wall performance, but performance is much lower than Green Glue, especially at low frequencies. Green Glue is also lower in cost and much faster to apply than MLV. While hanging MLV limply is a common recommendation, using it as the center of a sandwich performs better here.



	Reference	Green Glue	MLV Sandwich	MLV Limply Hung
Layer 1	5/8" Drywall 5/8" Drywall	5/8" Drywall Green Glue 5/8" Drywall	5/8" Drywall MLV 5/8" Drywall	5/8" Drywall 5/8" Drywall MLV Hung Limply
Framework	2x4 wood studs, 24" OC R13 fiberglass insulation			
Layer 2	5/8" Drywall 5/8" Drywall	5/8" Drywall Green Glue 5/8" Drywall	5/8" Drywall MLV 5/8" Drywall	MLV Hung Limply 5/8" Drywall 5/8" Drywall

Resilient Channel

improved on just one side of the wall

5/8" Drywall Each Side

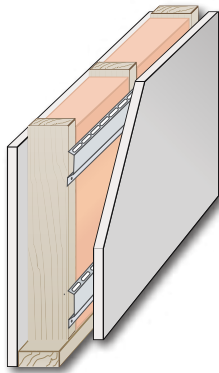

STC = 48
test number: OL 08 0342
single 5/8" drywall on each side

1/2" Soundproof Drywall One Side

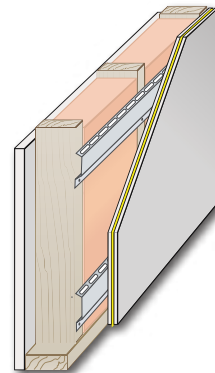

STC = 50
test number: OL 08 0518
Low cost 1/2" "soundproof drywall" on one side of the wall

5/8" Soundproof Drywall One Side

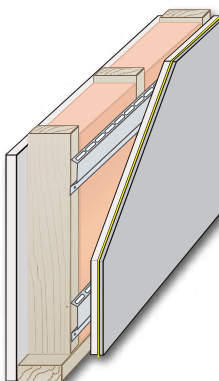

STC = 54
test number: OL 08 0604
High cost 5/8" "soundproof drywall" on one side of the wall

1 Tube Green Glue One Side

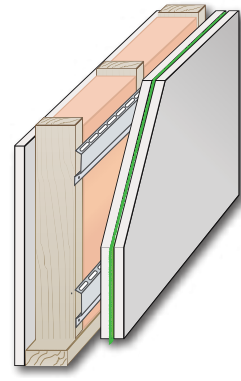

STC = 58
test number: OL 08 0520
Green Glue and double 5/8" drywall on one side of the wall. 1 tube of Green Glue was used per 4' x 8' area (very economical)

Green Glue construction – heavier and lower in cost than constructions utilizing engineered "soundproof" drywall – outperforms the competition. Green Glue is particularly good in cost/performance.

Staggered Studs

improved on both sides of the wall

5/8" Drywall Each Side

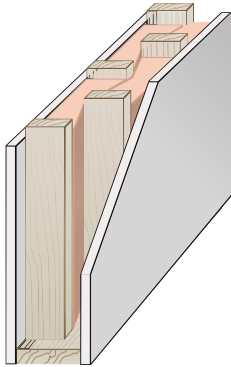

STC = 44

Test number: OL 06 0607

Reference with one layer of 5/8" drywall each side

5/8" Drywall with MLV

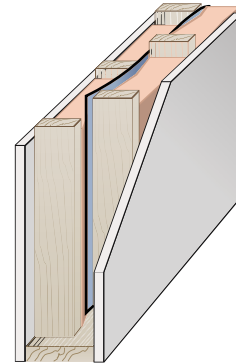

STC = 47

Test number: OL 07 0305

MLV woven around the studs with one layer of 5/8" drywall each side

2 Layers of 5/8" Drywall Each Side

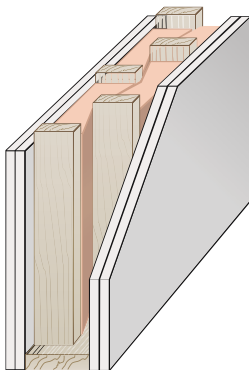

STC = 53

Test number: OL 06 0635

Double 5/8" drywall each side of staggered studs

2 Tubes Green Glue Each Side

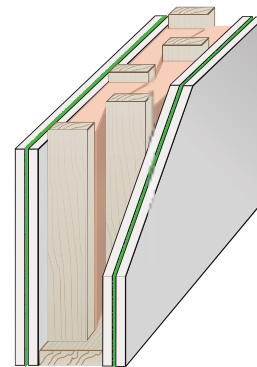

STC = 62

Test number: OL 07 0530

2 tubes of Green Glue sandwiched between 2 layers of 5/8" drywall each side

Green Glue outperforms soundboard and limp mass materials.

Wood Studs - Different Glues

improved on both sides of the wall

Reference

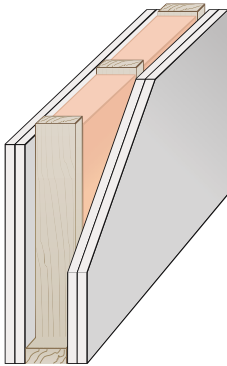

STC = 45

Test number: OL 06 0607

Reference with no glue and 2 layers of 5/8" drywall each side

Silicone

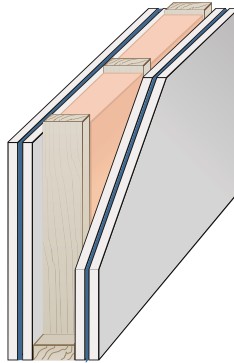

STC = 47

Test number: OL 08 0604

Silicone adhesive sandwiched between 2 sheets of .5/8" drywall both sides each side

Conventional Adhesive

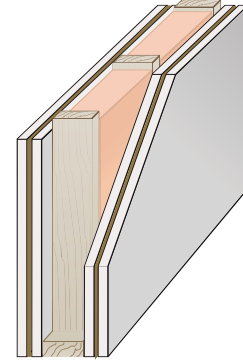

STC = 37

Test number: OL 06 0912

Conventional drywall adhesive sandwiched between 2 sheets of 5/8" drywall each side

1 Tube Green Glue Each Side

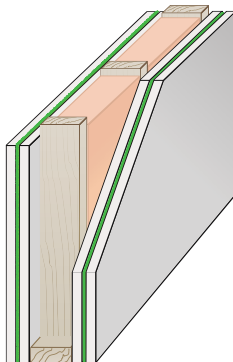

STC = 52

Test number: OL 06 0919

Green Glue and 2 layers of 5/8" drywall on each side of the wall. 1 tube of Green Glue was used per 4'x8' area (very economical)

2 Tubes Green Glue Each Side

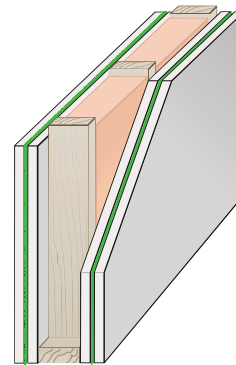

STC = 56

Test number: OL 06 0927

Green Glue and 2 layers of 5/8" drywall on each side of the wall. 2 tubes of Green Glue used per 4' x 8' area

Green Glue significantly outperforms alternate adhesives.

No off-the-shelf material performs as well.

Wood Studs - Factory Damped Drywall

improved on both sides of the wall

Single Layer Drywall

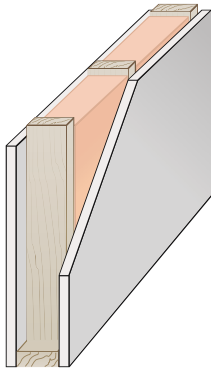

STC = 41
 Test number: OL 06 0604
 Reference with single sheet of 5/8" drywall on each side

Double Layer Drywall

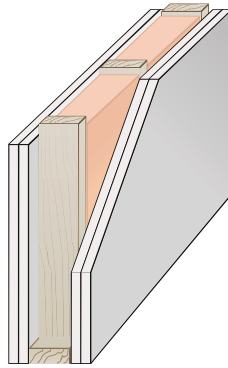

STC = 45
 Test number: OL 06 0607
 Reference with 2 sheets of 5/8" drywall on each side

1/2" Soundproof Drywall

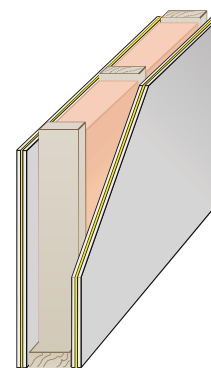

STC = 51
 Test number: OL 08 0509
 Low cost 1/2" "soundproof drywall" on each side

5/8" Soundproof Drywall with Metal

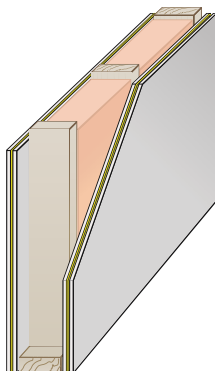

STC = 54
 Test number: OL 05 0820
 Expensive engineered "soundproof" drywall that contains metal

1 Tube Green Glue

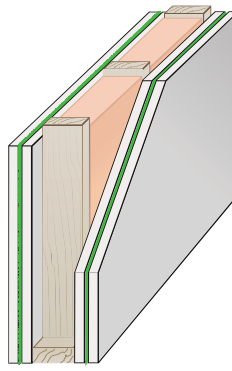

STC = 52
 Test number: OL 06 0920
 1 tube of Green Glue sandwiched between 2 layers of 5/8" drywall on each side

2 Tubes Green Glue

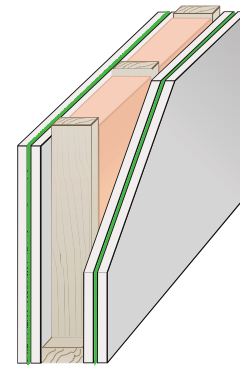

STC = 56
 Test number: OL 06 0927
 2 tubes of Green Glue sandwiched between 2 layers of 5/8" drywall on each side

Green Glue outperforms engineered "soundproof" drywall both in absolute performance and especially in cost/performance. Additionally, the heavier Green Glue assemblies offer superior low frequency isolation.

Wood Studs - Other Materials

improved on both sides of the wall

Double Layer Drywall

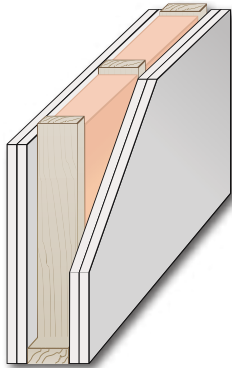

STC = 45

Test number: OL 06 0607

Reference assemble with 2 layers of 5/8" drywall on each side

Soundboard

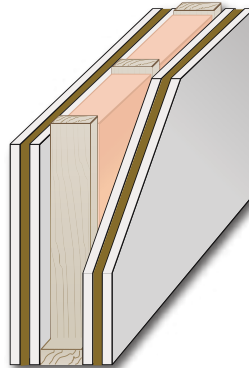

STC = 49

Test number: OL 07 0812

Soundboard sandwiched between 2 layers of 5/8" drywall on each side

MLV Sandwich

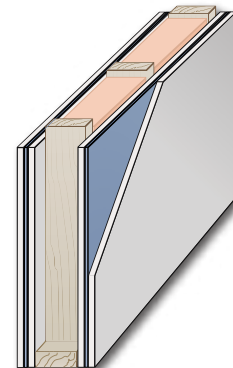

STC = 51

Test number: OL 07 0820

Mass loaded vinyl sandwiched between 2 layers of 5/8" drywall on each side

MLV Limply Hung

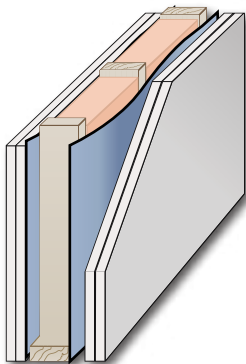

STC = 51

Test number: OL 07 0819

Mass loaded vinyl limply hung with 2 layers of 5/8" drywall on each side

1 Tube Green Glue

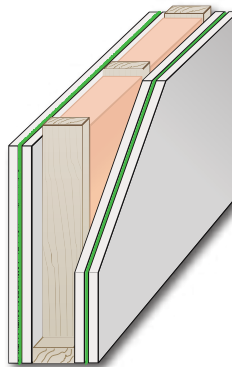

STC = 52

Test number: OL 06 0920

1 tube of Green Glue sandwiched between 2 layers of 5/8" drywall on each side

2 Tubes Green Glue

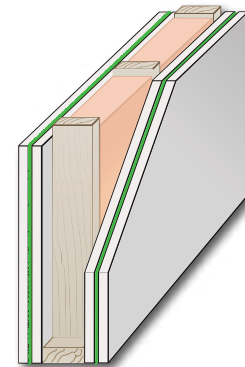

STC = 56

Test number: OL 06 0927

2 tubes of Green Glue sandwiched between 2 layers of 5/8" drywall on each side

Green Glue outperforms soundboard and limp mass materials.

Introducing Green Glue Noiseproofing Clips



Mechanically separating two sides of a wall can improve sound transmission by allowing one side to vibrate independently from the other. That's the basic principle behind Green Glue Noiseproofing Clips and it works incredibly well. When used in combination with Green Glue Noiseproofing Compound, more than 95 percent more noise can be stopped than through conventional construction.

Green Glue Noiseproofing Clips were designed with maximum low frequency sound isolation in mind, so walls fortified with our clips will eliminate the bass sounds most commonly found with home entertainment and theater systems.

Unlike Resilient Channel, Green Glue Noiseproofing Clips can not be short circuited. Which, as explained earlier, is a major reason why Resilient Channel constantly underperforms expectations.

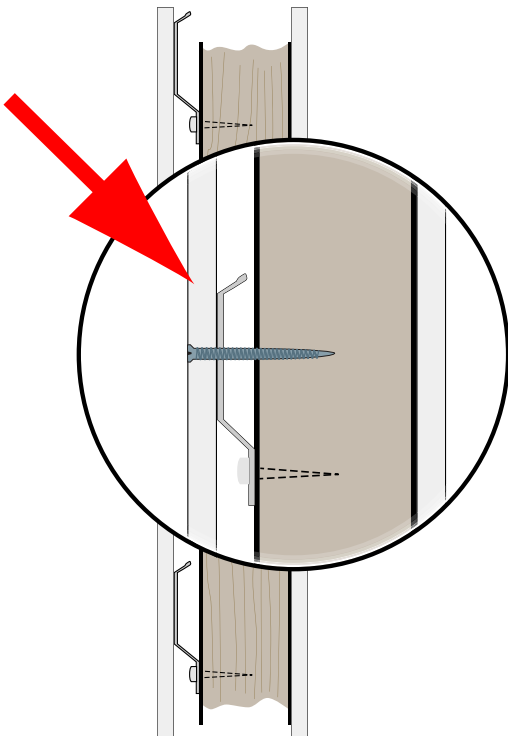

GREEN GLUE

noiseproofing clip
installation guide

Product Specifications

Width	1.25 inch
Height	4.25 inch
Depth	1 inch
Weight	.025 lbs
Max Spacing	48" on center
Recommended Load	36 lbs ~ 3 drywall layers
Max Safe Load	46 lbs ~ 4 drywall layers
Fail Load	300 lbs ~ 27 drywall layers

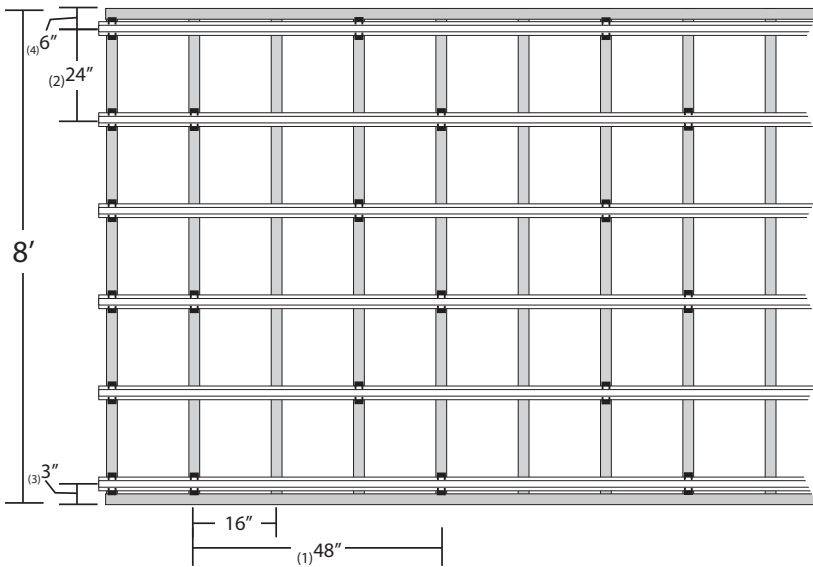

Layout pattern for Green Glue Noiseproofing Clips

Green Glue Noiseproofing Clip layout

- (1) Clips are spaced no further than 48 inches apart horizontally
- (2) Hat channel must not be spaced more than 24 inches vertically
- (3) Bottom clips must be less than 3 inches from the floor
- (4) Top clips must be less than 6 inches from the ceiling

*Clips must be placed at the outermost studs on every piece of hat channel

Step 1

Measure for placement of Green Glue Noiseproofing Clips using layout guidelines listed above. Mark locations and install clips using appropriate screws.

Recommended screws by stud type

Wood:	Use #8 x 2-1/2" coarse thread screws
Steel:	Use #8, 10 or 12 x 1-5/8" Type S self-tapping screws
Concrete:	Use 3/16" dia x 2-1/4" Tapcon or equal anchor Screw

Outermost clips must be placed at every interval to support the ends of the hat channel

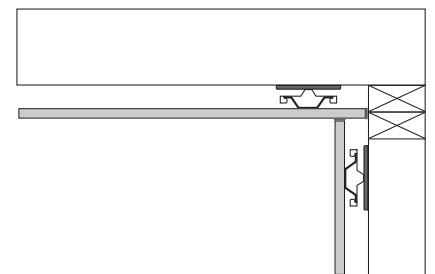

Install ceiling drywall before walls to allow for a fire stop by butting ceiling drywall to studs



Step 2

Snap appropriate hat channel into clips

Recommended hat channel

Walls:	25 gauge hemmed edges
Ceilings:	22 gauge
Depth:	7/8"
Width Top:	1 1/4"
Width Bottom:	2 1/2"

Most walls will require you to overlap hat channel, instructions for doing so are as follows. Overlap 6 inches of hat channel between two clips. Secure the hat channel with two 7/16" framing screws. 18 gauge tie-wire can also be used.



Step 3

Place shims on the floor to allow spacing between the drywall and the flooring. This ensures decoupling from the floor to make it impossible for vibrations to travel from wall to floor and vice-versa.

Screw drywall in place through hat channel. Be sure drywall is fully installed before removing shims from underneath.

Step 4

Be sure to use an acoustical sealant to fill gaps around electrical boxes, windows, doors, and areas below or above sheets of drywall. Green Glue Noiseproofing Sealant is perfect for this application as it allows flexibility while stopping sound from transmitting through unsealed areas.



Green Glue Noiseproofing Clips - Single Layer of Drywall

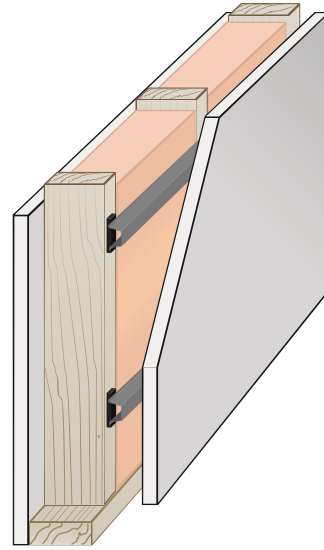
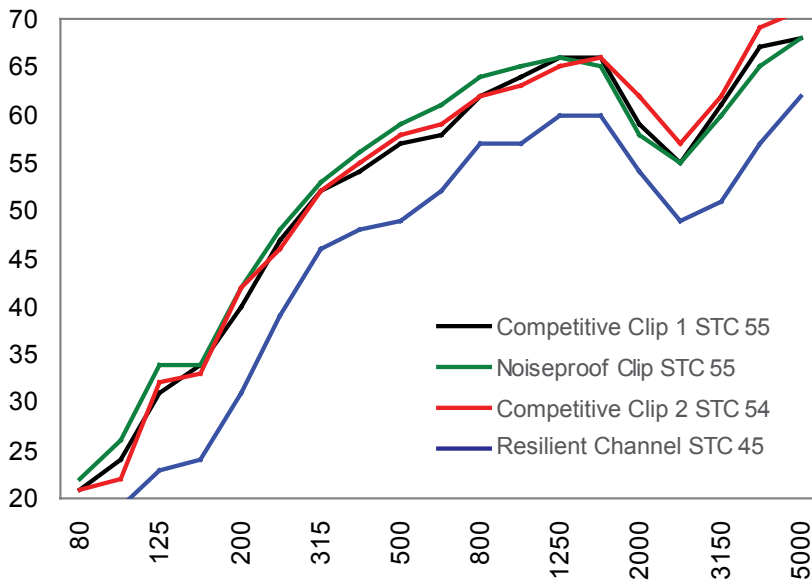

Type	Test number	STC
Green Glue Noiseproofing Clips	OL 08 0708	55
Competitive Clip 1	OL 08 0345	55
Competitive Clip 2	OL 08 0501	54
Resilient Channel	OL 08 0336	45

Green Glue Noiseproofing Clips have a higher STC rating than competitive clips. It is also true that our clips are designed to perform exceptionally well at low frequencies as indicated by the graph above.



	Competition 1	Competition 2	Noiseproofing Clips	Resilient Channel
Layer 1	5/8" Drywall 25 Gauge hat channel Competitive Clip 1	5/8" Drywall 25 Gauge hat channel Competitive clip 2	5/8" Drywall 25 Gauge hat channel Noiseproofing Clips	5/8" Drywall Resilient Channel
Framework	2x4 wood studs, 16" OC R13 fiberglass insulation			
Layer 2	5/8" Drywall	5/8" Drywall	5/8" Drywall	5/8" Drywall

Green Glue Noiseproofing Clips - Double Layer on Clip Side

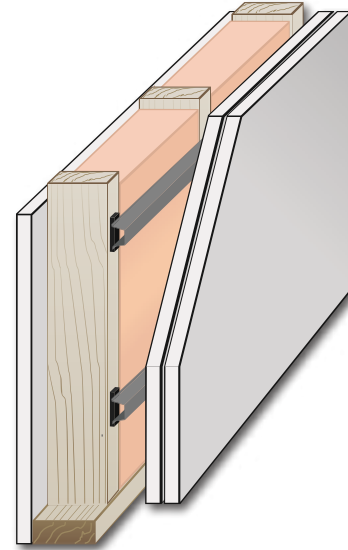
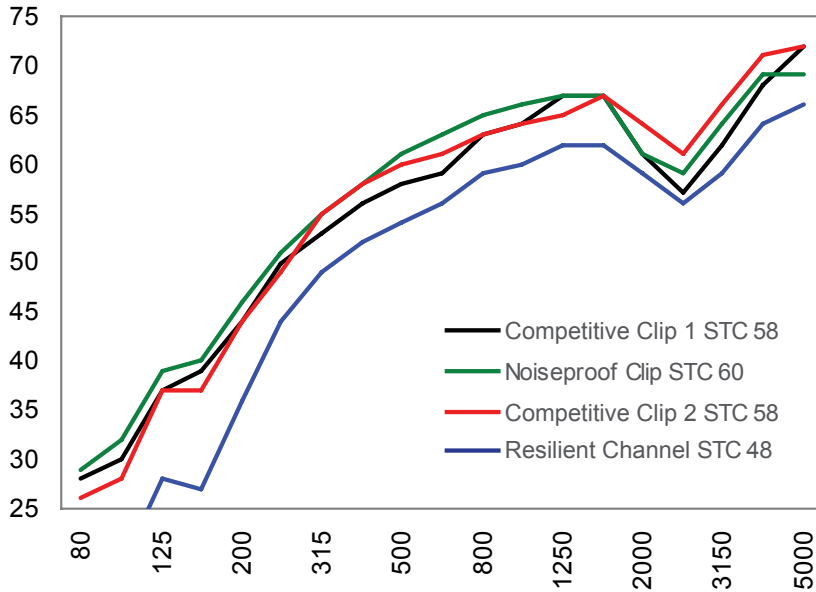

Type	Test number	STC
Green Glue Noiseproofing Clips	OL 08 0712	60
Competitive Clip 1	OL 08 0346	58
Competitive Clip 2	OL 08 0502	58
Resilient Channel	OL 08 0337	48

Adding mass to a wall by installing a second layer of drywall is always a good thing. Adding a second layer of drywall to Noiseproofing Clips improves the transmission loss of the structure much more than our competitors. Again, the Green Glue continues to excel at lower frequencies.

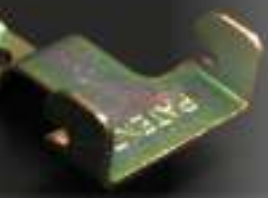

	Competition 1	Competition 2	Noiseproofing Clips	Resilient Channel
Layer 1	5/8" Drywall 5/8" Drywall 25 Gauge hat channel Competitive Clip 1	5/8" Drywall 5/8" Drywall 25 Gauge hat channel Competitive Clip 2	5/8" Drywall 5/8" Drywall 25 Gauge hat channel Noiseproofing Clips	5/8" Drywall 5/8" Drywall Resilient Channel
Framework	2x4 wood studs, 16" OC R13 fiberglass insulation			
Layer 2	5/8" Drywall	5/8" Drywall	5/8" Drywall	5/8" Drywall

Green Glue Noiseproofing Clips - Double Layer Both Sides

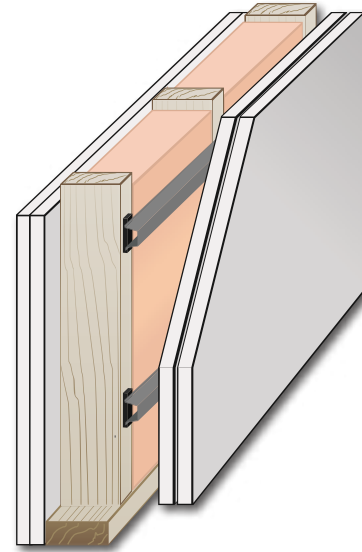
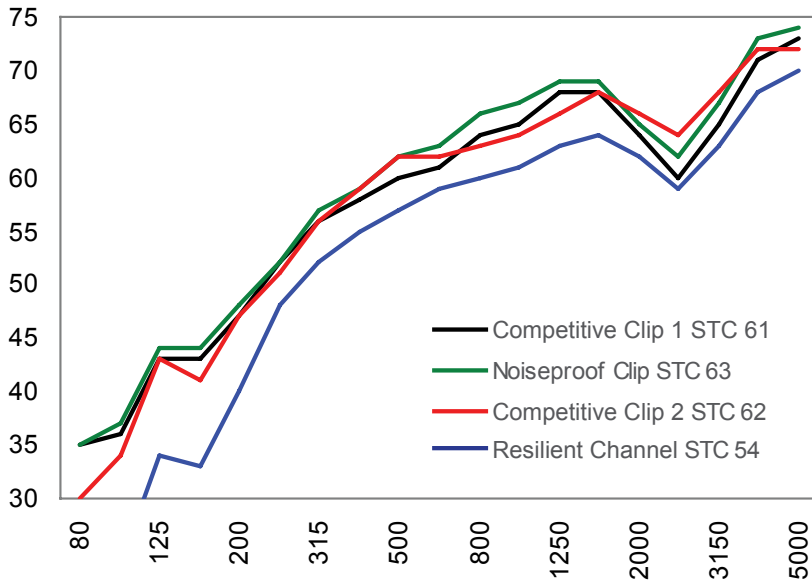

Type	Test number	STC
Green Glue Noiseproofing Clips	OL 08 0708	63
Competitive Clip 1	OL 08 0345	61
Competitive Clip 2	OL 08 0501	62
Resilient Channel	OL 08 0338	54

Double layers of drywall on each side of an assembly yield the best results without using additional materials, such as Green Glue, to improve transmission loss.



	Competition 1	Competition 2	Noiseproofing Clips	Resilient Channel
Layer 1	5/8" Drywall 5/8" Drywall 25 Gauge hat channel Competitive Clip 1	5/8" Drywall 5/8" Drywall 25 Gauge hat channel Competitive Clip 2	5/8" Drywall 5/8" Drywall 25 Gauge hat channel Noiseproofing Clips	5/8" Drywall 5/8" Drywall Resilient Channel
Framework	2x4 wood studs, 16" OC R13 fiberglass insulation			
Layer 2	5/8" Drywall 5/8" Drywall	5/8" Drywall 5/8" Drywall	5/8" Drywall 5/8" Drywall	5/8" Drywall 5/8" Drywall

Green Glue Noiseproofing Sealant

- **Water based, non-toxic, very low VOC formulation**
- **Water clean up**
- **Low odor**
- **Easy to apply, no applicator fatigue**
- **Freeze/thaw stable**
- **Long shelf life**
- **Paintable, muddable**
- **Dried film contains no plasticizers or other potentially volatile components, which promotes long life (the sealant will not slowly dry out and crack with age)**
- **Exceptional properties in acoustic applications including high edge damping, exceptional aging characteristics, and high flexibility**
- **Economical relative to other esoteric sealants**



Cracks between walls, ceilings, and floors compromise the sound isolation of any room by allowing noise to penetrate into adjoining rooms. Simply adding Green Glue Noiseproofing Sealant to your soundproofing project can reduce noise transmission by 100 times or more.

Green Glue Noiseproofing Sealant can be applied as easily as any standard caulking material. It fits into a quart-sized caulking gun and is applied along the edges and joints between floors and walls and ceilings and walls for maximum performance. Green Glue Noiseproofing Sealant can also be painted once dry.

Green Glue Noiseproofing Sealant exceeds LEED green building requirements, is low V.O.C., and is low odor. It can be easily cleaned while still wet with soap and water.

Introducing Green Glue Noiseproofing Joist Tape

Loud footsteps and the squeaky noises they can cause on floorboards don't have to be a fact of life. Help avoid this annoyance with Green Glue Noiseproofing Joist Tape.

With Green Glue's patented tape roller, installation is easy. Roll the joist tape onto the joist, adhesive side down, and install the subfloor directly on top.

In addition to providing sound isolation, Green Glue Noiseproofing Joist Tape's low thermal conductivity improves energy efficiency. Green Glue Noiseproofing Joist Tape conforms easily to irregular surfaces and does not break down or deteriorate from mild acids, alkalis and mildew.



Green Glue Noiseproofing System

Our noiseproofing system is designed to work together to give the most complete solution on the market.

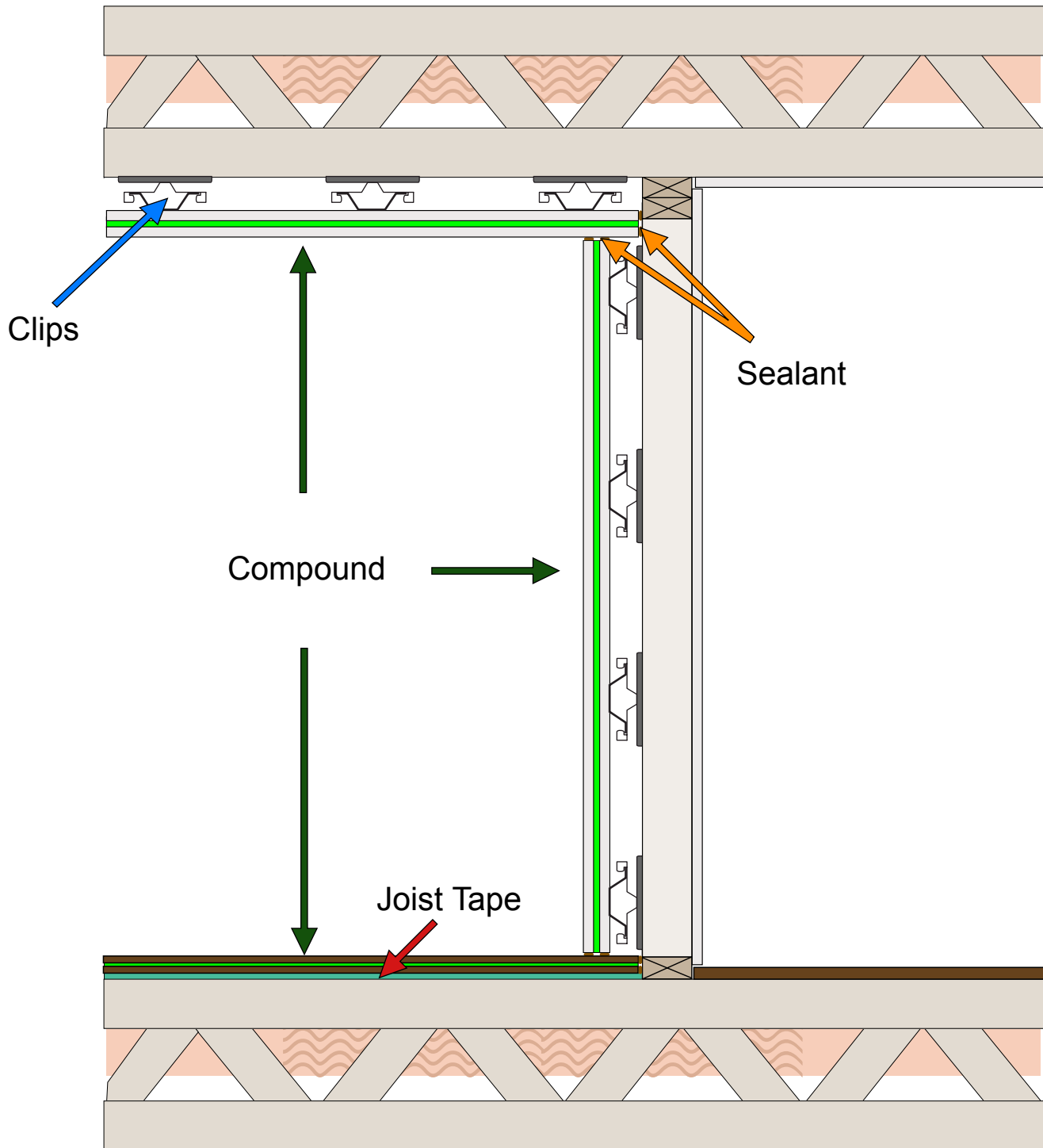

Shared Walls

One of the biggest sound problems people have is the transmission of sound from one room to another. Multifamily homes, with a shared wall between, can be hard to live in when noise travels easily from one unit to the next. Adding a layer of Green Glue and drywall to the shared wall can greatly reduce the amount of sound traveling through it and will take care of all but the most severe noise problems.

One problem to be aware of when doing any kind of soundproofing is flanking noise. Flanking noise, as shown below, can be described as any kind of sound traveling through non direct paths. If you share joists with your neighbor, you will most likely experience a large amount of flanking. Sound will not only be traveling through the air cavity shared in the ceiling, but will also vibrate the joists themselves and transfer noise that way.

Also shown below is the effect duct work has on sound transmission. Whenever ventilation goes from room to room, it is always going to be transmitting noise through the open air. One way to resolve this problem is by using duct liner to help insulate the inside of the duct work. This will help to dissipate the sound before it reaches the opening on the other end.

One of the most important things in any kind of sound isolation project is making sure you have a proper seal. If there are large gaps between the drywall on the wall and the drywall on the ceiling, no amount of soundproofing done to the wall will be able to stop the sound leaking through those cracks.

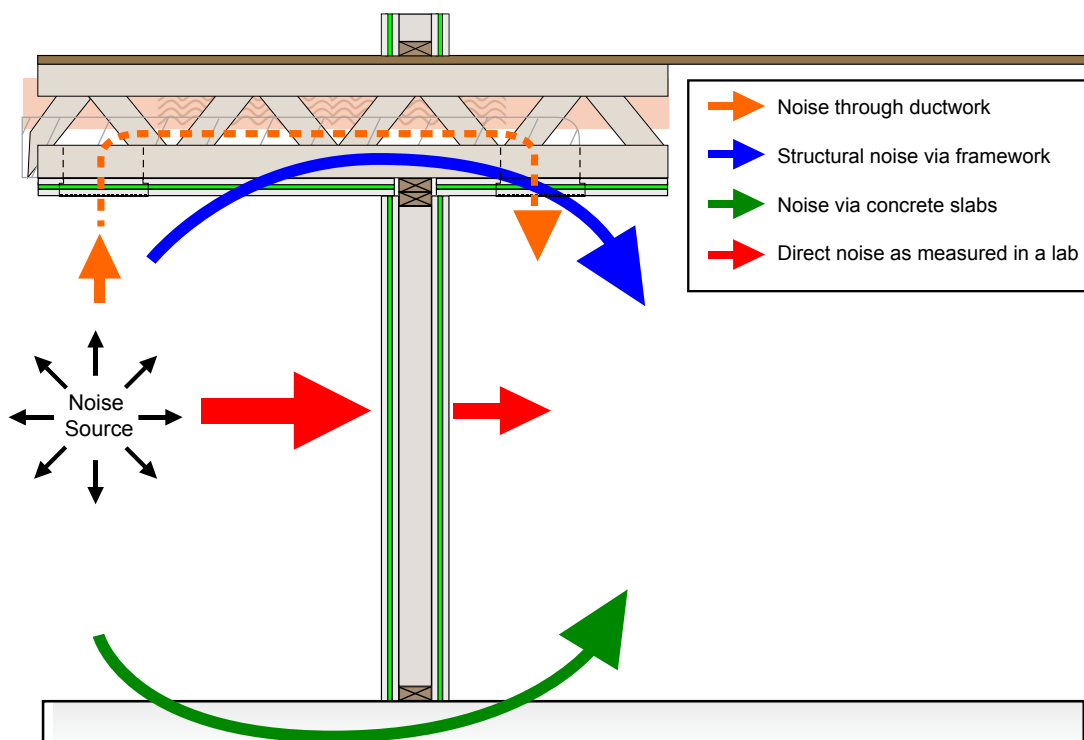

Exterior Noise

When dealing with exterior noise, 9 times out of 10 the problem isn't with the wall, it is with the windows and doors. Windows and doors can be treated similarly to walls in a sense. For windows, having 2 panes of glass as far apart as possible and as heavy as possible will yield the best results. Doors are very similar. By having a double door, you will be better suited to stop sound than with a single door. Again, the heavier the doors and the farther apart the doors are, the better they will be at stopping sound.

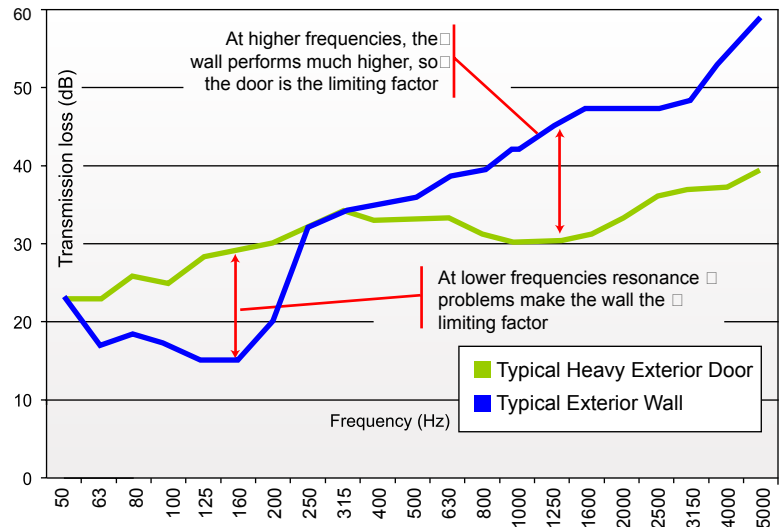

Windows and doors, much like walls, need to be properly sealed. Making sure there are no air gaps under the door or around the window will greatly increase the amount of sound it will be able to stop. Even with all of this, windows and doors will still be your weakest link when it comes to blocking exterior sound.

There are other ways to help improve the amount of sound windows and doors can stop other than what is described above. Adding some type of acoustic foam around the perimeter of the window between the two panes will help absorb some of the sound in the air cavity.

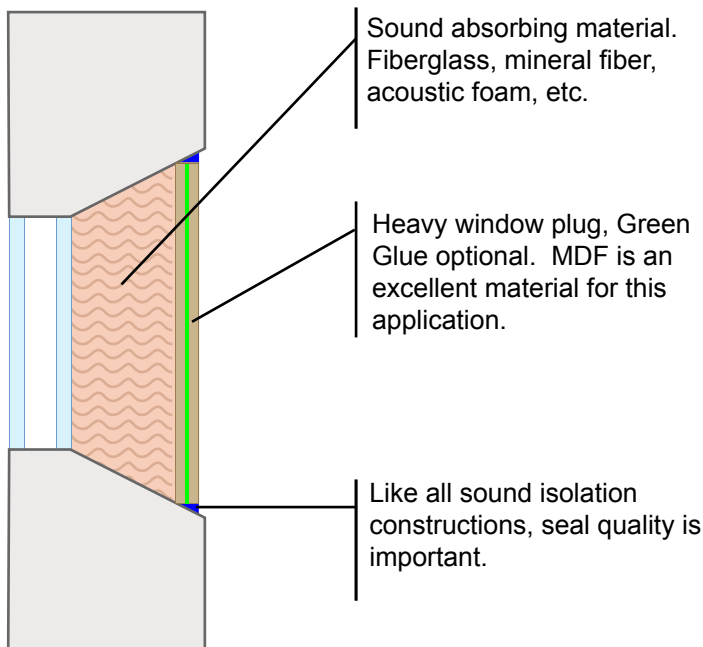

If a window is not being used for lighting, like in a basement home theater for example, a window plug may be used. A window plug is very simple. By filling in the air cavity with insulation and adding a Green Glue sandwich over the opening, the amount of sound coming through that window will be greatly reduced. As with every soundproofing project, an air tight seal around the perimeter is necessary to achieve maximum sound isolation. Window plugs can also be removable, allowing the window's traditional function to be utilized..

Footstep Noise

Footstep noise from upstairs neighbors is one of the most common problems people deal with. Unfortunately, it is one of the hardest problems to solve. In any soundproofing project, treating the problem at it's source is always the best way to fix a problem. By doing this, you can reduce the chance of flanking noise becoming a problem. Simply adding Green Glue to the ceiling, in most cases, will not be able to stop footstep noise from being heard in the room below. This is due to the large amount of flanking noise being transmitted through the walls.

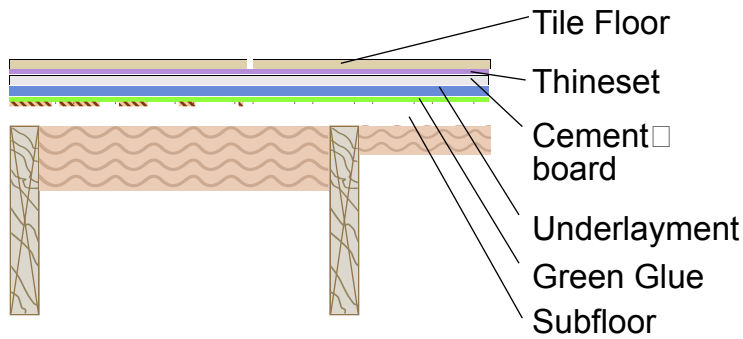

A combination floor assembly

Treating the sub floor of the room above is the best way to treat impact noise. Adding a second layer of sub flooring with Green Glue will greatly reduce the amount of sound traveling through to the room below. Using Green Glue in conjunction with an underlayment is an even better way to reduce impact noise. The image to the left shows typical installation for utilizing Green Glue with an underlayment and tile flooring.

In most cases, treating the floor of the unit above is not an option, either because of the type of flooring or due to lack of cooperation. The next best thing from treating the floor from the top is treating it from the bottom. The image below shows layers of drywall with layers of Green Glue between the joists and attached to the floor above. This method is much more labor intense and requires the use of caulking material to make a proper seal.

Carpet and padding are the best ways to isolate impact noise. The carpet and pad act as an underlayment of sorts helping to prevent impact vibrations from actually getting to the sub floor. Therefore, using carpet and padding on top of a Green Glue sub floor sandwich is one of the best situations when dealing with impact noise.

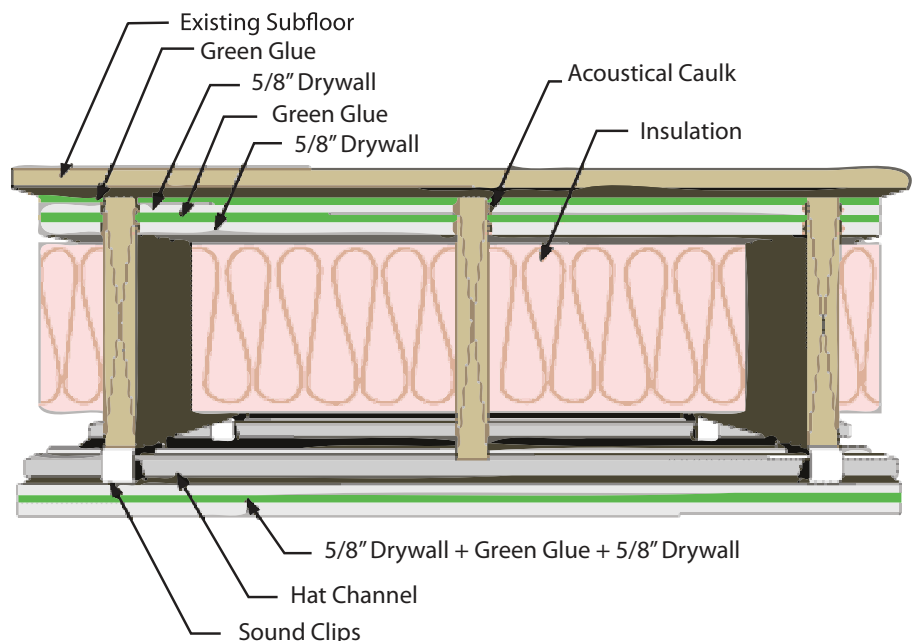

GREEN GLUE

noiseproof your life





GREEN GLUE

noiseproof your life

contact your certainteed
sales representative or call
800.233.8990