

Quick Start Guide NORTHGATE® ClimateFlex®

Refer to www.certainteed.com or the *Master Craftsman® Shingle Applicator's Manual* for complete detailed application instructions.

NorthGate® ClimateFlex® shingles have the installer-friendly NailTrak® feature, which provides 1-1/2" wide nailing area and specially formulated QuadraBond laminating adhesive. Closed-cut valleys are preferred by CertainTeed when applying these shingles; however, open and woven valleys are also acceptable.

Fastening

Low and Standard Slope (2:12 – 21:12)

Use four nails for every full NorthGate® ClimateFlex® shingle.

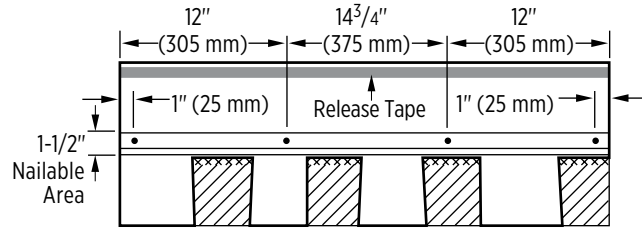

Step Slope (>21:12)

Use six nails and four spots of asphalt roofing cement for every full NorthGate® ClimateFlex® shingle.

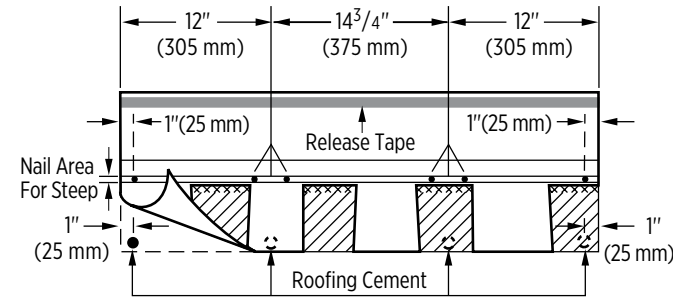

Starter Installation

1. Use CertainTeed Swiftstart Starter, or three-tab shingles with the lower tab portions removed. Be sure that the starter shingles are at least 7-5/8" in height.

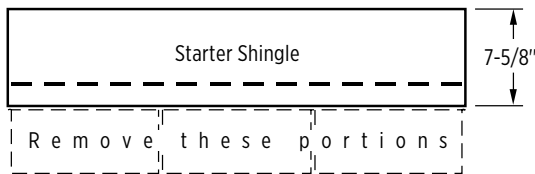

Fastening: Use 4 nails, located as shown below

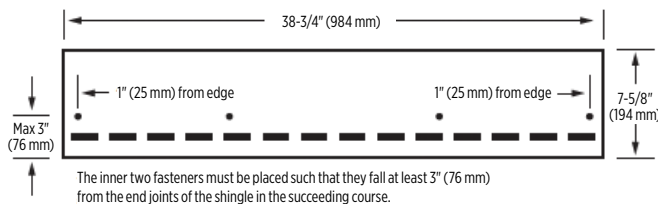

2. For the first starter, cut 6" off.
3. Apply the remaining piece to the lower left corner of the roof.
4. Use full length starter shingles for the rest of the course.

Five Course Diagonal Method (6" and 11")

1st Course: Apply a full shingle at the lower left corner of the roof, flush with the edges of the starter course.

2nd Course: Cut 6" off the left end of the shingle and save this piece for later use. Apply the 32-3/4" long piece.

3rd Course: Cut 11" off the shingle and save this for later. Install the 27-3/4" long piece.

4th Course: Apply the previously removed 11" long piece.

5th Course: Apply the previously removed 6" long piece. Install a full shingle against the right edge of each shingle in courses one through five. Apply all shingles with a 5-5/8" exposure.

Continuing Up The Roof

1. Beginning again with a full shingle, repeat the five-course pattern up the left rake.
2. Fill-in courses across the roof in a stepped diagonal fashion using full shingles. Do not run courses straight across.

Important: Do not align joints of shingles closer than 4" from one another.

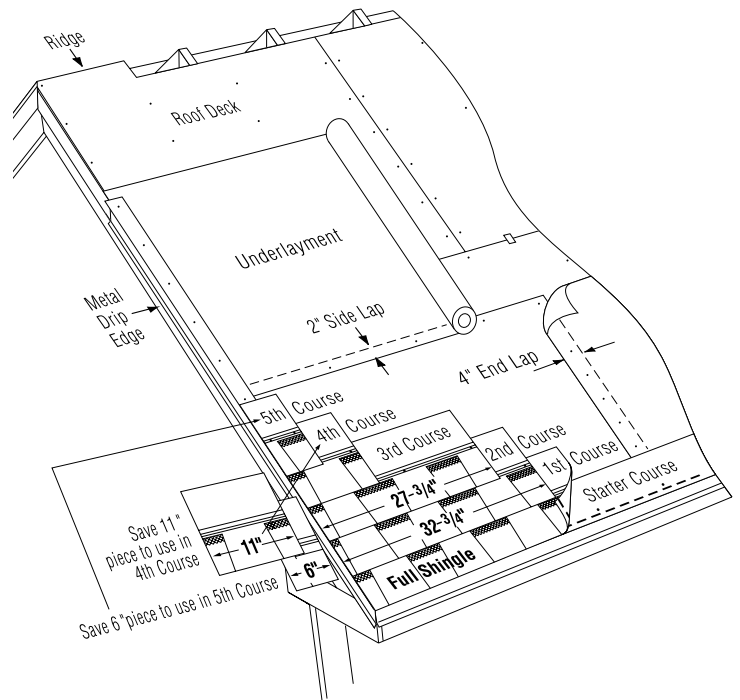

**WATCH NORTHGATE
CLIMATEFLEX VIDEOS**



Refer to www.certainteed.com or the *Master Craftsman® Shingle Applicator's Manual* for complete detailed application instructions.

Hip and Ridge Installation

These shingles have an accented shadow line that is designed to complement these shingles. Simply fold along the pre-cut lines and detach individual cap pieces.

Shadow Ridge ClimateFlex® Shingles

There are 24 three-piece units in each bundle, providing 72 individual caps that will cover 30 linear feet of a hip or ridge. Each cap piece is 12" x 12" and features clipped corners on the bottom edge of the exposed portion.

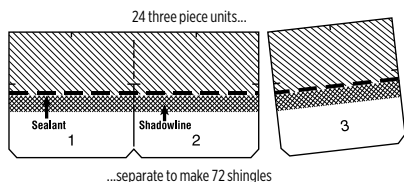

Apply primary roofing up to hip or ridge on both sides of roof and trim flush. Ensure that the Shadow Ridge ClimateFlex shingles will adequately cover the top course of the shingles on both sides of the hip and ridge.

Start by cutting off the bottom 5-5/8" (143 mm) of one Shadow Ridge ClimateFlex shingle and applying the 7-5/8" x 12" piece over hip or ridge by bending this starter shingle along its centerline and forming into place, see A. Align butt edge to the bottom of the hip or to either end of ridge, flush with the edges of the in-place primary shingles. Fasten with two (2) fasteners - minimum 1-3/4" (45 mm) long, see A.

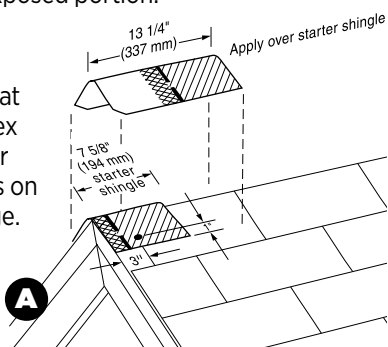

Then apply a full 12" x 12" piece over starter, bending the shingle along its centerline and forming into place over the hip or ridge, flush with the bottom and sides of the starter shingle. Fasten with two (2) fasteners - minimum 1-3/4" (45 mm) long, see B.

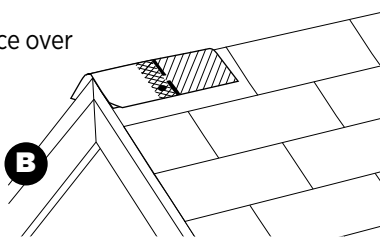

Continue application of Shadow Ridge ClimateFlex shingles up the ridge or along the ridge, forming each shingle over the hip or ridge, and fasten as shown in Fastening. Expose Shadow Ridge ClimateFlex shingles 5" (125 mm) covering all fasteners, see C.

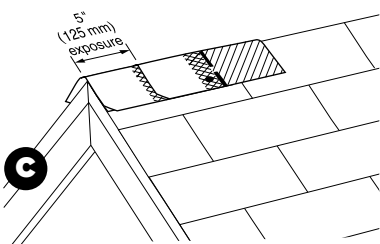

Note: The notches on each shingle may be used to help center the shingle on the ridge and to ensure the 5" (125 mm) exposure.

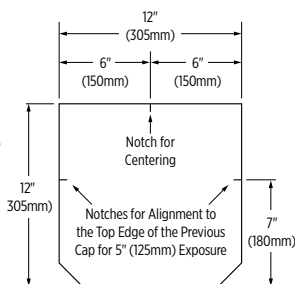

Shadow Ridge ClimateFlex 4PC Shingles

There are 24 four-piece units in each bundle, providing 96 individual caps that will cover 45 linear feet of a hip or ridge. Each cap piece is 13-1/4" x 9-7/8" and features clipped corners on the bottom edge.

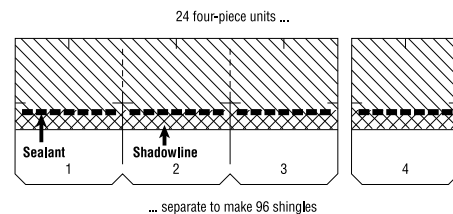

Apply primary roofing up to hip or ridge on both sides of roof and trim flush. Ensure that the Shadow Ridge ClimateFlex 4PC shingles will adequately cover the top course of the shingles on both sides of the hip and ridge.

Start by cutting off the bottom 5-5/8" (143 mm) of one Shadow Ridge ClimateFlex 4PC shingle and applying the 7-5/8" x 9-7/8" piece over hip or ridge, see D.

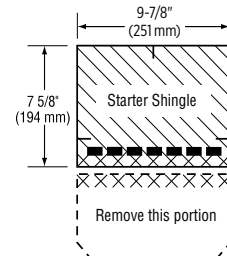

Align butt edge to the bottom of the hip or to either end of ridge, flush with the edges of the in-place primary shingles. Fasten with two (2) fasteners - minimum 1-3/4" (45 mm) long, see E.

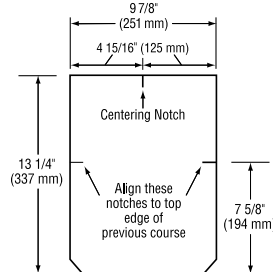

Then apply a full 13-1/4" x 9-7/8" piece over starter, bending the shingle along its centerline and forming into place over the hip or ridge, flush with the bottom and sides of the starter shingle. Fasten with two (2) fasteners - minimum 1-3/4" (45 mm) long.

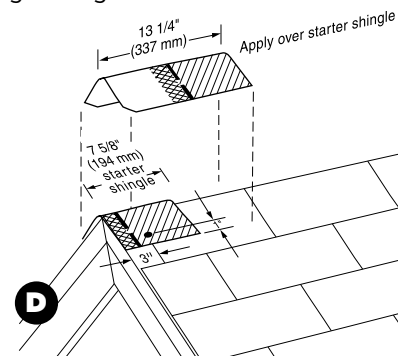

Continue application of Shadow Ridge ClimateFlex 4PC shingles up the ridge or along the ridge and fasten as shown in Fastening. Expose Shadow Ridge ClimateFlex 4PC shingles 5-5/8" (143 mm) covering all fasteners, see F.

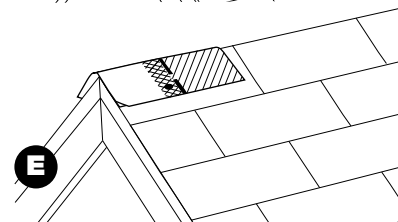

Note: The notches on each shingle may be used to help center the shingle on the ridge and to ensure the 5-5/8" (143 mm) exposure.

