

Presidential® Shake® and Presidential® Shake® TL 16

YOUR OBJECTIVE:

To learn the correct procedures for installing Presidential Shake and Presidential Shake® TL shingles

PRESIDENTIAL SHAKE AND PRESIDENTIAL SHAKE TL SHINGLES

Presidential Shake and Presidential Shake TL shingles are a premium oversized (14-1/4" x 40") roofing product.

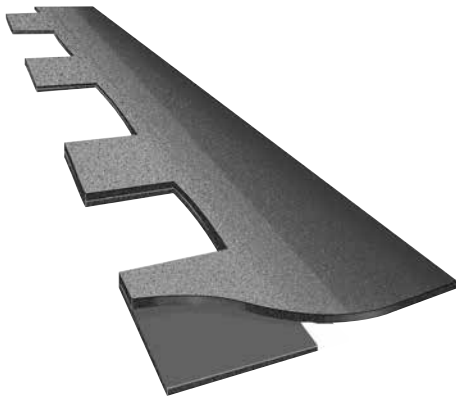

Figure 16-1: Presidential Shake Shingle.

Presidential has the depth and dimension of hand-split cedar shakes. The incomparable Presidential TL is a super-heavyweight shingle constructed using Tri-Laminate Technology — two base layers and a top layer of premium materials. To add a custom design aesthetic, utilize our *Special Effects* color combinations where two different colored shingles can be combined to create a one of a kind look.

Use matching Mountain Ridge Solaris hip and ridge shingles which are also solar reflective.

Presidential Shake IR and Presidential Shake TL meet UL 2218 Class 4 impact resistance rating.

NOTE: This product must be installed over a clean deck (no roof-overs) and Presidential impact resistant starter shingles as well as hip and ridge cap accessories must be used to obtain the UL 2218 Class 4 rating.

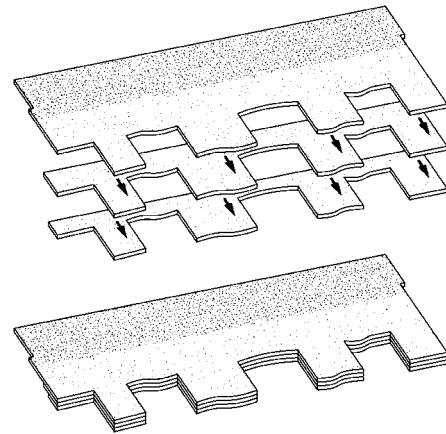

Figure 16-2: Presidential TL Tri-Laminate Construction.

Fastening, low slope underlayment and flashing requirements, are special because of the thickness, design and weight of these shingles. Open valleys are recommended; however, closed-cut valleys are also acceptable. Woven valleys are not recommended when applying Presidential and Presidential TL because the laminated shingle can buckle and become damaged when shaped into the valley.

On lower-sloped roofs where water drains slowly and due to the Presidential TL tri-laminate design, step flashing details are important to ensure a water-tight roof. Extra precautions such as putting a slater's-edge on step flashings under the shingle or applying two beads of asphalt cement lengthwise along the top of the step shingle (perpendicular to the shingle) should be considered when there are multiple roof penetrations or vertical obstructions in close proximity to each other (ex. several skylights on the same roof plane or a skylight close to a vertical wall).

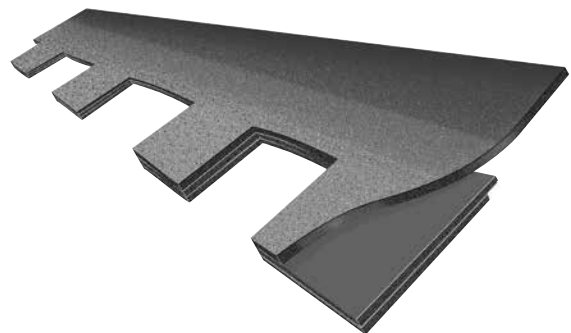

Figure 16-3: Layers of a Presidential TL.

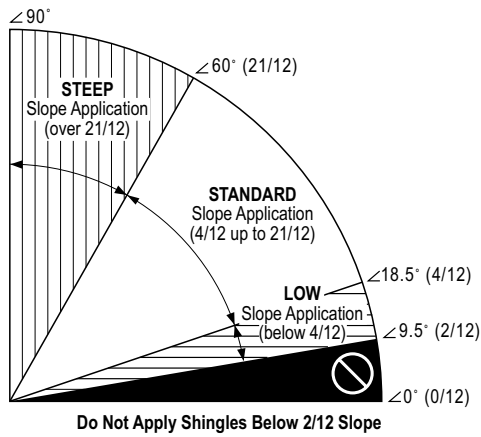

Figure 16-4: Slope definitions

The roof deck* must be at least: 3/8" (9.5 mm) thick plywood, or 7/16" (11 mm) thick non-veneer, or nominal 1" (25 mm) thick wood deck.

STANDARD OR STEEP SLOPES: CertainTeed recommends DiamondDeck® or RoofRunner™ Synthetic Underlayment or shingle underlayment meeting ASTM D226, D4869 or D6757. Always ensure sufficient deck ventilation, and take particular care when DiamondDeck, RoofRunner or other synthetic underlayment is installed. Follow manufacturer's application instructions.

LOW SLOPES: All roof shingles applied to a low slope deck (2" to below 4" per foot) require the use of CertainTeed WinterGuard® or VYCOR® Waterproofing Shingle Underlayment, or its equivalent, * applied over the entire deck surface. Consult the WinterGuard or VYCOR® and individual shingle application instructions for details.

* For Presidential Shake applied to low slopes, underlayment equivalents to WinterGuard or VYCOR® include:

- 1) waterproofing shingle underlayments meeting ASTM D1970;
- 2) in areas not prone to snow or ice, two layers of 36" (915 mm) wide felt shingle underlayment lapped 19" (485 mm).
- 3) in areas not prone to snow or ice, two layers CertainTeed's DiamondDeck or RoofRunner in shingle fashion (half lap) per the low-slope application instructions

Shingle underlayment should meet ASTM D6757, ASTM D4869 Type 1 or ASTM D226 Type 1. Ensure sufficient deck ventilation when DiamondDeck, RoofRunner or other synthetic underlayment is installed. (One layer of shingle underlayment meeting ASTM D4869 applied over the required WinterGuard or VYCOR® is also recommended.

IMPORTANT: Presidential Shake TL, applied to low slopes requires the use of WinterGuard or VYCOR® or a waterproofing shingle underlayment meeting ASTM D1970. Two layers of felt or synthetic underlayment IS NOT an acceptable alternative to WinterGuard or VYCOR®.

Cold Weather Climates (All Slopes): Application of WinterGuard or VYCOR® or a waterproofing shingle underlayment meeting ASTM D1970 is strongly recommended whenever there is a possibility of ice build-up. Follow manufacturer's application instructions.

SEALING: Shingle sealing may be slowed if the shingles are applied in cool weather and may be further delayed by airborne dust accumulation. We recommend hand-sealing when weather conditions are likely to prevent the factory-applied sealant from activating.

CAUTION: To prevent cracking, shingles must be warm enough to allow proper forming for hips, ridges and valleys.

FLASHING: Corrosion-resistant flashing must be used to help prevent leaks where a roof meets a wall, another roof, a chimney or other objects that penetrate a roof.

WARRANTY: These shingles are warranted against manufacturing defects and are covered by SureStart™ protection. See the warranty itself for specific details and limitations.

NOTE: To be eligible for the Wind Warranty upgrade, the starter shingle at the rake(s) is required to be SwiftStart. For complete Wind Warranty upgrade requirements, please see the Wind Warranty section of Chapter 2 of this manual and CertainTeed's Asphalt Shingle Residential Products Limited Warranty.

For technical questions, information on acceptable alternative materials, or a copy of the product warranty, contact the sources listed below:	Warranty	Technical Questions
Your supplier or roofing applicator	✓	
CertainTeed Customer Experience 800-233-8990	✓	
CertainTeed-RPG Technical Services 800-345-1145	✓	✓

FASTENING

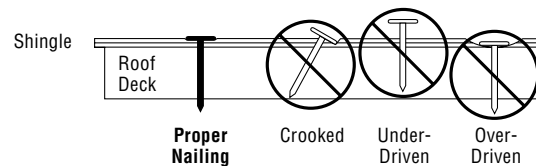

Figure 16-5: Proper and improper nailing.

IMPORTANT: For decks 3/4" (19 mm) thick or thicker, nails must go at least 3/4" (19 mm) into the deck. On thinner decks, nails must go at least 1/8" (3.2 mm) through the deck.

Nails must be 11- or 12-gauge roofing nails, corrosion-resistant, with at least 3/8" (9.5 mm) heads, and at least 1-1/4" (31 mm) long.

LOW AND STANDARD SLOPE:

For low and standard slopes, use five nails for each full Presidential shingle as shown below.

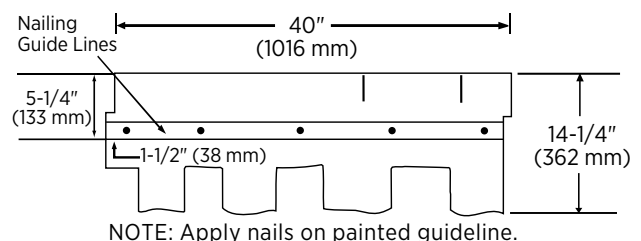

Figure 16-6: Fastening Presidential and Presidential TL shingles on low and standard slopes.

STEEP SLOPE:

For steep slopes, use nine nails for each full Presidential shingle and apply 1" diameter spots of asphalt roofing cement under each shingle tab.

After applying 5 nails in between the nailing guide lines, apply 4 nails 1" above tab cutouts making certain tabs of overlying shingle cover nails.

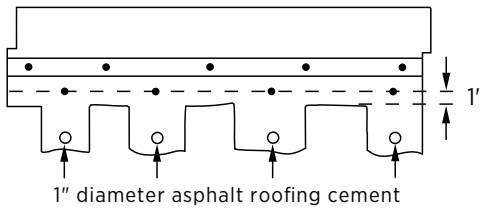

Figure 16-7: Fastening Presidential and Presidential TL shingles on steep slopes.

CAUTION: Too much roofing cement can cause shingles to blister.

ALIGNMENT AND SHIPLAP NOTCHES

To maintain the correct 5" and 15" diagonal offset pattern, use the Alignment Notches at 5-1/2" and 15-1/2" from the right edge of the shingle. These notches are pre-cut into the top of each shingle and serve as a shingle placement guide for the shingles being installed in the course above them.

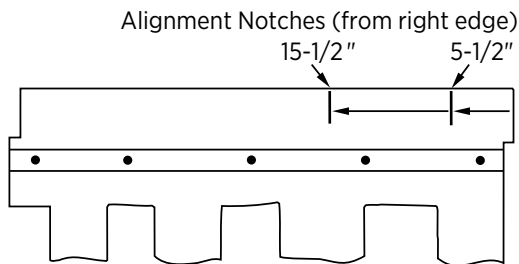

Figure 16-8: Use the alignment notches to ensure shingles are applied at a 5" and 15" diagonal offset.

Shiplap Notches on the left and right side of each shingle are used to ensure the proper 4" exposure is continued across shingle courses by lining up the shiplap notches of adjacent shingles.

ONE CLEAN DECK APPLICATION METHOD

NOTE: Shingle applications are on 5" and 15" offsets with a 4" exposure. Apply shingles up the left side of the roof to establish the pattern and fill in to the right. When cutting shingles, always apply the right hand portion (cut-off the left side.) Use the pieces cut off the left rake, hip, or valley to complete courses at the right rake.

PREPARING THE DECK:

- ◆ Apply underlayment as required. CertainTeed suggests that a layer of shingle underlayment be applied. For UL fire rating, underlayment is generally required. Apply flat and unwrinkled.
- ◆ Snap horizontal and vertical chalklines to assure shingles will be correctly aligned.

IMPORTANT!

PRESIDENTIAL STARTER:

Use TWO (2) OVERLAPPING LAYERS of CertainTeed's "Presidential Starter" shingles, applied in the following fashion, starting at left rake/eaves corner. Starting at the right rake/eaves corner is not permitted. The staggered top edge of the starter pieces will allow a smooth and uniform transition for applied shingles.

- 1. BOTTOM STARTER COURSE LAYER:** Cut 20" off the first bottom piece. Apply remaining 13-1/4" x 20" piece, followed by full 13-1/4" x 40" pieces along the eave. **DO NOT REMOVE THE PERFORATED TOP SECTION.** Extend the shingles over the rake and eaves about 1/2" (13 mm) if drip edge is used, or about 3/4" (19 mm) if no drip edge is used.

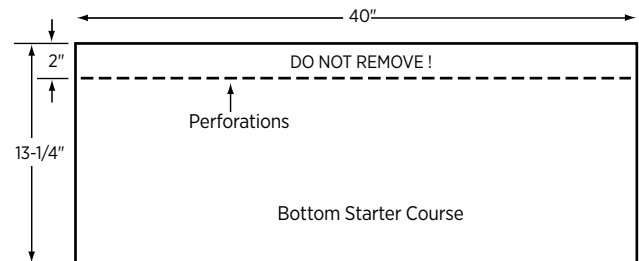

Colored granules matching the shingle blend are to be exposed at lowermost edge of roof.

Figure 16-9: Presidential Starter (bottom starter course.)

- 2. TOP STARTER COURSE LAYER:** Remove the 2" perforated top section. Cut 2" off the left side of the first top piece only. Install the 11-1/4" x 38" piece over and flush to the bottom starter course. Continue with 11-1/4" x 40" top course pieces over the rest of the bottom starter course.

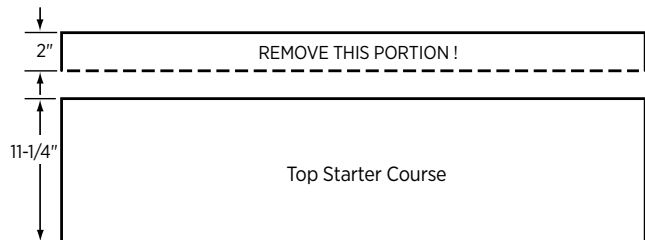

Figure 16-10: Presidential Starter (top starter course.)

Here's a Tip...

When establishing the 4-course shingle pattern, use the proper alignment notches to determine where to cut the shingles on the left hand side. For example, install the first course full shingle, then place a full shingle above it by lining up the right side edge with the 5-1/2" alignment notch in the 1st course shingle below, then fasten and trim the 2nd course shingle along the rake edge. Likewise, use the 15-1/2" alignment notch at the top of the 2nd course shingle to place the right side edge of the 3rd course shingle. Finally, use the 5-1/2" alignment notch at the top of the 3rd course shingle to place the 4th course shingle

NOTE: The exposed colored granules on the "top" starter shingles must match the Presidential/Presidential TL shingle colors.

Fasteners should be placed about 1" and 13" in from both ends of a full length starter shingle. Fasteners for less than full 40" starter shingles should be placed about 1" in from each end and evenly spaced no more than 13" apart (2, 3 or 4 fasteners may be used on shorter starter shingles depending on the length.)

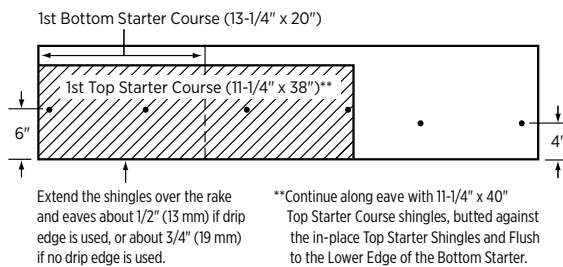
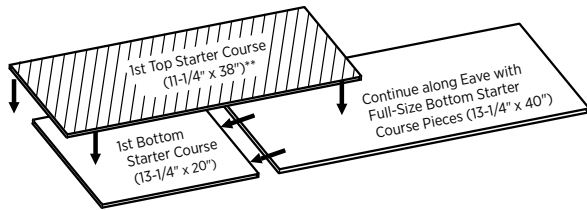

Figure 16-11: Use two (2) overlapping layers of CertainTeed's "Presidential Starter."

5" AND 15" OFFSET, FOUR-COURSE DIAGONAL METHOD. EXPOSE ALL SHINGLES 4" (102 MM).

1ST COURSE: Start at left rake, hip or valley and apply a full shingle.

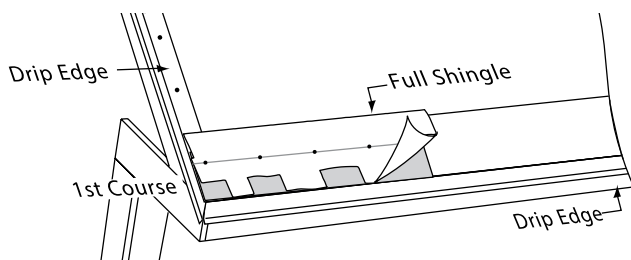

Figure 16-12: First Course.

2ND COURSE: Cut 5" from the left edge of the first shingle. Install the remaining 35" piece by lining up the right lower edge with the 5-1/2" alignment notch in the top of the First Course shingle.

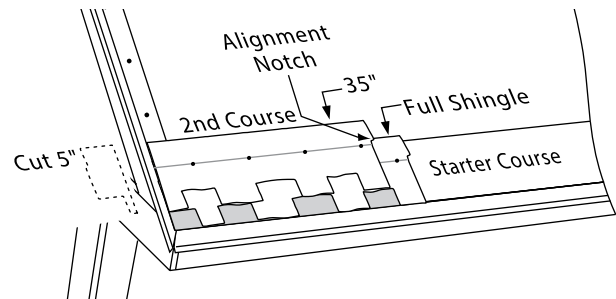

Figure 16-13: Second Course.

3RD COURSE: Cut 20" from the left edge of the first shingle. Install the remaining 20" piece by lining up the right lower edge of the shingle with the 15-1/2" alignment notch in the top of the Second Course shingle.

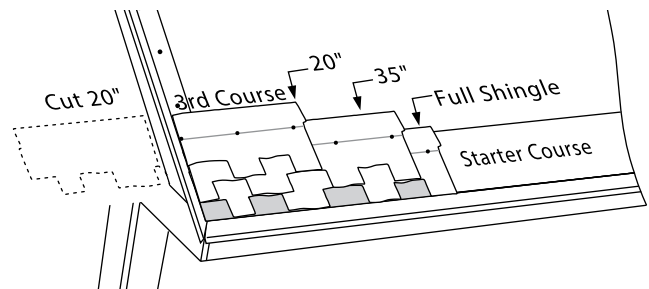

Figure 16-14: Third Course.

4TH COURSE: Cut 25" from the left edge of the first shingle. Install the remaining 15" piece by lining up the right lower edge of the shingle with the 5-1/2" alignment notch in the top of the Third Course shingle.

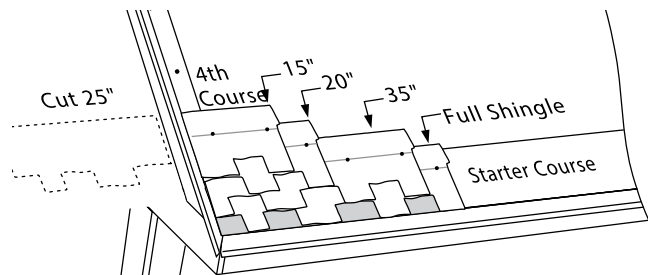

Figure 16-15: Fourth Course.

Here's a Tip...

After establishing the 4 course shingle pattern, extend the 1st course by installing additional full shingles along the eave. Using the proper alignment notch in the shingle course below to maintain the 5" and 15" offset, build the courses up the roof by working "back and forth" across the roof deck. (Be careful to maintain the correct offsets!)

Figure 16-16: Highlight of step flashing details.

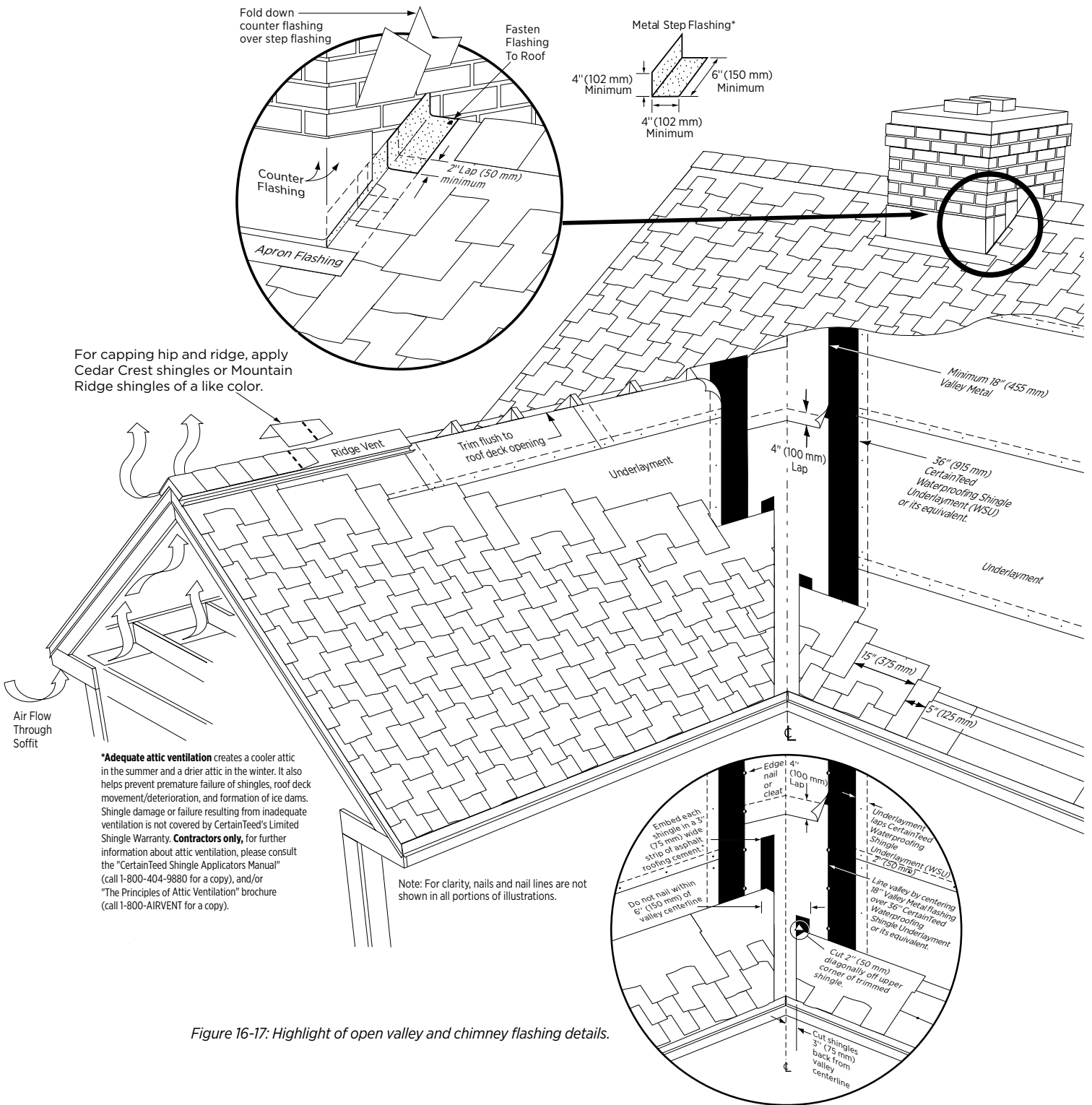

Figure 16-17: Highlight of open valley and chimney flashing details.

SUCCEEDING COURSES: Start the Fifth Course by installing a full shingle and repeat the four-course pattern. Continue applying shingles filling into the right of the first four courses.

Another Way to View it:

The 5" and 15" offset pattern is established over the 4 courses as follows:

1st course shingle = 40" L (full shingle)

2nd course shingle = 35" L (1st course – 5")

3rd course shingle = 20" L (2nd course – 15")

4th course shingle = 15" L (3rd course – 5")

An alternative to starting on the left:

Follow the same application instructions specified in the 5" and 15" Offset Method above except instead of starting at the left rake, strike a chalkline perpendicular to the eave, at least 10' from the rake's edge. Install the First Course full shingle by aligning its left edge with the perpendicular chalk-line. Follow the 5" and 15" Offset Method instructions for the remaining courses.

IMPORTANT: The designed appearance and service of Presidential Shake Shingles requires strict adherence to the application instructions.

"SPECIAL EFFECTS" PRESIDENTIAL SHAKE SHINGLES

DUAL COLOR APPLICATION METHODS USING THE 5" AND 15" OFFSET

METHOD # 1 – ALTERNATING COLORS – SINGLE COURSES

1. Select color combinations of Presidential® Shake shingles for use in dual color application, e.g. Slate Gray and Weathered Wood. Color designations "A" and "B" for two different shingle colors will be used in the following shingle application instructions.
2. **STARTER COURSE:** Apply color "A" Starter Strip shingles as starter course and follow instructions for Starter Course application.
3. **1ST COURSE:** Apply color "B" Presidential Shake shingles to the first course. Follow instructions for First Course application. All shingles applied to the first course and all successive odd numbers will be the same color i.e., color "B".
4. **2ND COURSE:** Apply color "A" shingles to second course. Follow instructions for Second Course application. All shingles applied to the second course and all successive even numbers will be the same color i.e., color "A".

5. Every other course of shingles will alternate between colors "A" and "B". Complete shingle application to each course across the roof deck with the same color of shingles. To avoid confusion, completely fill in each course of shingles across the deck at the same time. Follow the appropriate installation instructions for Presidential Shake shingles.
6. **HIP & RIDGE:** Apply hip & ridge cap shingles that are the opposite color as that of the last course of Presidential Shake Shingle. For example, if the last (top) course of Presidential Shake Shingle is color "A", then hip and ridge cap shingles should be color "B".

METHOD #2 – ALTERNATING COLORS – DOUBLE COURSES

1. Select color combinations of Presidential Shake Shingles for use in dual color application, e.g. Slate Gray and Weathered Wood. Color designations "A" and "B" for two different shingle colors will be used in the following shingle application instructions.
2. **STARTER COURSE:** Apply color "A" Starter Strip Shingles as starter course and follow instructions for Starter Course application.
3. **1ST COURSE:** Apply color "A" Presidential Shake Shingles, same color as starter shingles, to the first course. Follow instructions for First Course application.
4. **2ND AND 3RD COURSE:** Apply color "B" shingles to the second and third courses. Follow instructions for Second Course and Third Course applications.
5. **4TH AND 5TH COURSES:** Apply color "A" shingles to the fourth and fifth courses. Follow instructions for Fourth Course and Fifth Course applications.
6. All succeeding courses continue with two courses of shingles of one color followed by two courses of shingles of the other color. To avoid confusion completely apply the two courses of same colored shingles at the same time. Follow the appropriate installation instructions for Presidential Shake shingles.
7. **HIP & RIDGE:** The hip & ridge shingle color to be used will depend upon the color of the last two courses of Presidential shingles. If the last two courses contain shingles of the same color, then the hip & ridge color will be the opposite color. For example, if the last two courses are color "A", then the color "B" hip & ridge shingles are used. If the last two courses of shingles are different in color, then the color of hip & ridge shingles will be the same as the last course of Presidential Shake shingle. For example, if the next to last course is color "A" and the last (top) course is color "B", then the Hip & Ridge color used is "B".

Here's a Tip...

To provide a level surface for hip and ridge caps applied over Presidential TL, a "nailer" made from 1-by boards can be installed or a piece of metal can be formed to support the caps. Also ridge vents made from sturdy material can serve as a base to provide an even uniform appearance.

CAPPING THE HIP AND RIDGE

Cedar Crest® or Mountain Ridge® accessory shingles can be used for covering hips and ridges. Apply shingles up to the ridge. Fasten each accessory with two fasteners. The fasteners must be 1-3/4" long or longer, so they penetrate either 3/4" into the deck or completely through the deck.

MOUNTAIN RIDGE HIGH-PROFILE HIP AND RIDGE ACCESSORY SHINGLES

Use Mountain Ridge accessory shingles to cover hips, ridges or rake edges. One box will cover 20 linear feet. To prevent damage to shingles during application, they must be sufficiently warm to allow proper forming.

FASTENING

IMPORTANT: Use two nails to fasten each shingle. Nails must be minimum 1-3/4" (45 mm) long. For the 4" (102 mm) starter shingle, place fastener 1" (25 mm) in from each side edge and about 2" (50 mm) from the rake (or eave) edge, making sure the fastener goes 3/4" into the deck or all the way through. For each full accessory shingle, place fasteners 8-5/8" (219 mm) up from its exposed butt edge and 1" (25 mm) in from each side edge.

HIP, RIDGE AND RAKE SHINGLE APPLICATION

Apply the primary field roofing up to the hip or ridge from both sides of the roof and trim flush or lap over one side, not more than half the width of an accessory shingle. Expose Mountain Ridge shingles 8", covering all fasteners.

Assure that the installed accessory shingles properly cover field shingles on both sides and along rake edges. For a rake edge installation, cut the field shingles flush to the rake edge. Apply accessory shingles ensuring they fit securely against the rake board. To assist in proper alignment, snap a chalk line parallel to the hip, ridge or rake along the line where the side edges of the accessory shingles should fall.

Prepare a 4" Starter shingle by cutting off the lower 8" color granule butt portion of one accessory shingle. Apply the 4" starter piece (with sealant nearest the outer edge) over the bottom corner of the hip or rake, or on either end of the ridge, overhanging the corner or end by approximately 1/2" and bending the starter shingle along its centerline to form into place (see figures below.) Install a nail on each side about 2" up from the starter shingle's exposed butt edge and 1" in from each side edge of the shingle. The 8" piece that was cut off may be used to finish the opposite end of hip, ridge or rake.

Next, apply a full Mountain Ridge® shingle over the installed starter shingle, bending it along its centerline and forming into place over the hip, ridge or rake, flush with the bottom and side edges of the starter shingle. Install a nail on each side of the shingle 8-5/8" up from the bottom edge and 1" in from each side edge.

Rake – Ensure field shingles at rake edge are flush with the outer edge of the rake board. Apply Mountain Ridge shingles fitting them snugly against the rake board. Use two color-coordinated aluminum trim or paneling nails, to pin the material to the fascia at 2" (50 mm) up from bottom edge and 2" (50 mm) and 3" (75 mm) in from front edge of shingle. (See Figure 16-18).

Continue application of the Mountain Ridge shingles along the hip, ridge or rake as shown.

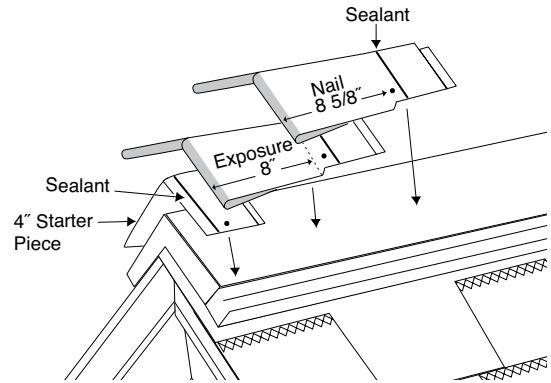
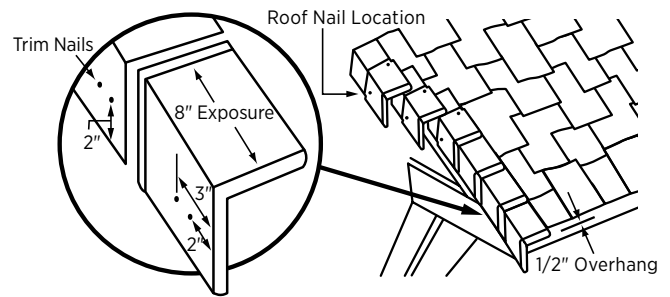

Figure 16-18: Mountain Ridge Rake edge application.



CEDAR CREST MEDIUM-PROFILE HIP AND RIDGE ACCESSORY SHINGLES

Use Cedar Crest® accessory shingles to cover hips and ridges. Carefully separate the three-piece units prior to application, by first folding along the pre-cut lines and then detaching the pieces (see Figure 16-19). No cutting is necessary. There are 30 individual shingles (10 three-piece units) in each bundle. One bundle will cover 20 linear feet. Each 12" x 12" (305 mm x 305 mm) shingle has a shadowline that is a design feature which is visible when applied properly. To prevent shingle damage during application, they must be sufficiently warm to allow proper forming.

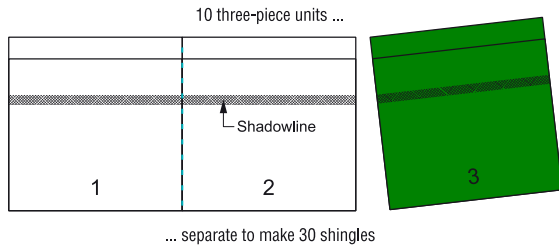

Figure 16-19: Separate to make 3 cap shingles.

FASTENING

IMPORTANT: Use TWO nails for each shingle. Fasteners must be minimum 1-3/4" (45 mm) long. All nail heads must be driven straight and must not cut into shingle surface. Nails must not be exposed on finished roof.

For the starter shingle, place fastener 1" in from each side edge and about 2" up from the starter shingle's exposed butt edge, making sure fastener goes 3/4" into the deck or all the way through the deck. (see Figure 16-20). For each full Cedar Crest shingle, place fasteners 8-5/8" up from its exposed butt edge and 1" in from each side edge (see Figure 16-21).

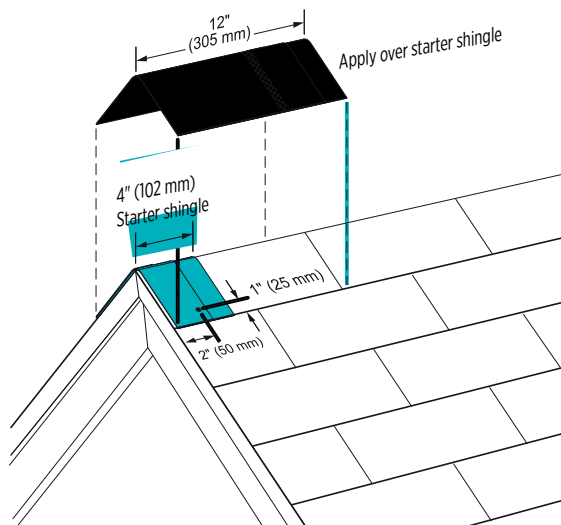

Figure 16-20: Apply a full cap shingle over the starter shingle.

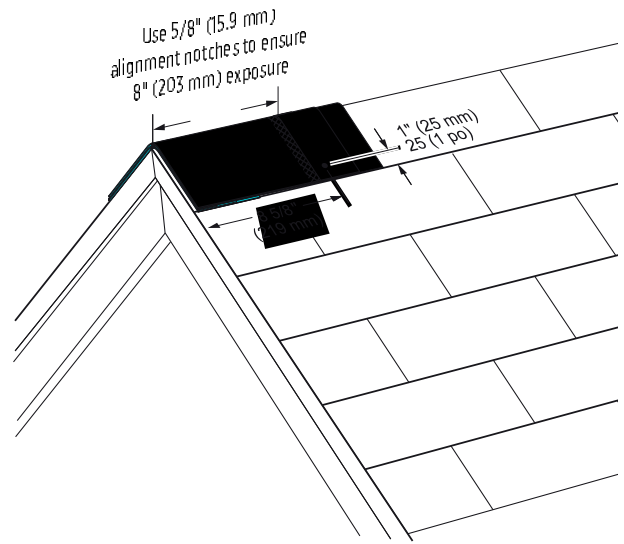

Figure 16-21: Install cap shingles at an 8" exposure and fasten with one nail on each side as shown.

IMPORTANT: High Wind Instructions. In order to achieve the ASTM D3161 Class "F" Wind Resistance Classification each "hip and ridge" shingle must be both 1) fastened with nails as detailed in Cedar Crest Application and 2) hand-sealed with two 1/4" (6 mm) wide beads of either BASF "Sonolastic® NP1™ Adhesive" or Henkel "PL® Polyurethane Roof and Flashing Cement" applied 8 5/8" (219 mm) up from the butt edge, and extending approximately 4" (102 mm) in from each side edge of the shingle's headlap as shown. Immediately align and apply the next overlying shingle, gently pressing tab sides into adhesive and ensuring none becomes visible. Only one side of the double thickness tab is laminated together; to secure the other side, after folding the shingle over the ridge and nailing into position, a 1" (25 mm) diameter spot of either NP1 or PL adhesive must be applied between the shingle layers as shown.

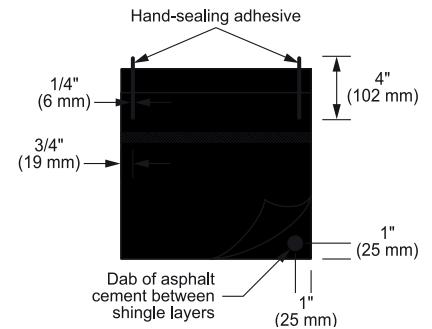

Figure 16-22: Hand seal caps as shown.

CEDAR CREST APPLICATION

Apply primary roofing up to hip or ridge on both sides of roof and trim flush. Ensure that the Cedar Crest shingles will adequately cover the top course of the shingles on both sides of the hip or ridge. Prepare a 4" (102 mm) "starter" shingle by cutting off the lower 8" (203 mm) color granule portion of one Cedar Crest shingle. Apply the 4" (102 mm) starter piece over the bottom corner of the hip or to either end of the ridge, overhanging the corner or end by approximately 1/2" (13 mm) and bending the starter shingle along its centerline to form into place (see Figure 16-20). Install a nail on each side about 2" (51 mm) up from the starter shingle's exposed butt edge and 1" (25 mm) in from each side edge of the shingle. Then apply a full 12" x 12" (305 mm x 305 mm) piece over the starter, bending the shingle along its centerline and forming it into place over the hip or ridge, flush with the bottom and side edges of the starter shingle. Utilizing the 5/8" (15.9 mm) notches located on either side of the shingle as a guide, position to help ensure the 8" (203 mm) exposure. Fasten with two (2) fasteners minimum 1-3/4" (45 mm) long with one (1) nail on each side of shingle 8 5/8" (219 mm) up from the butt edge and 1" (25 mm) in from each side edge (see Figure 16-21).

Continue application of Cedar Crest shingles up the hip or along the ridge, forming each shingle over the hip or ridge, and fasten as shown in Fastening. Expose Cedar Crest shingles 8", covering all fasteners.

To assist in proper alignment, snap a chalk line parallel to the hip or ridge applying along the line where the side edges of the Cedar Crest shingles should be.

NOTE: When applying Cedar Crest shingles on shingle-over ridge vents, cap shingles may need to be trimmed. Assure proper fit and avoid overhanging vent openings. Contact the ridge vent manufacturer for instructions specific to their product. Be especially careful to use fasteners of sufficient length to penetrate minimum 3/4" (19 mm) into solid decking or through the thickness of the decking, whichever is less. Use approved caulking material to fill gaps between vent and roof surface.

METAL STEP FLASHING

Metal flashing must consist of a piece extending a minimum 4" vertically and 4" into the field with a minimum 6" length. Figure 16-23.

Place each piece of flashing 2" up the roof from where the lowermost edge of the next (overlapping) shingle will be applied. Each succeeding course of flashing must "overlap" the flashing course below it a minimum of 2".

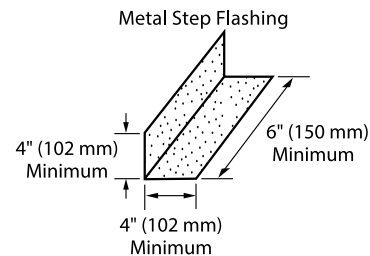

Figure 16-23: Metal step flashing.

REROOFING

"TEAR-OFF"

CertainTeed recommends but does not require old roofing be removed before installation of these products. Inspect the condition of the roof to determine that the load bearing capacity is adequate for the application of the Presidential® shingles. If the old roof consists of two or more layers of shingles, it is required to remove (tear-off) the existing roofing. After tear-off, repair the decking and /or install new decking and apply new underlayment, eaves flashing, and Presidential shingles using the recommended procedure.

"ROOF-OVER"

Over Asphalt Shingles:

IMPORTANT: If Presidential shingles are applied over existing roofing shingles, special "nesting" application methods must be followed. Applied incorrectly, raised shingle edges may result which can give an objectionable appearance and reduce the performance of the roofing.

If Presidential Shake Shingles are installed over existing wood shingles, replace old wood shingles along eave and rake edges with 1" (25 mm) x 4" (102 mm) boards. Beveled wood strips 4" (102 mm) x 5" (127 mm) wide may be installed below butt of shingles to provide a solid nailing base. Install Presidential Shake shingles using the recommended procedures.



**Presidential® Series
Installation Video**