

VOLTEX[®] & VOLTEX[®] DS

BENTONITE GEOTEXTILE WATERPROOFING SYSTEM
FOR CAST-IN-PLACE CONCRETE APPLICATIONS



VOLTEX® & VOLTEX® DS

BENTONITE GEOTEXTILE WATERPROOFING FOR CAST-IN-PLACE CONCRETE APPLICATIONS

CONTENTS

WHAT IS SODIUM BENTONITE?

PRODUCT DESCRIPTION

ASSOCIATED SYSTEM PRODUCTS

ACCESSORIES

LIMITATIONS

INSTALLATION GUIDELINES

SECTION 1: UNDERSLAB INSTALLATION

- 1.1 Substrate Preparation
- 1.2 Installation
- 1.3 Pile Caps & Grade Beams
- 1.4 Slab Penetrations
- 1.5 Elevator Pits
- 1.6 Edge of Slab, Backfilled Walls
- 1.7 Edge of Slab, Property Line Walls

SECTION 2: PROPERTY LINE CONSTRUCTION

- 2.1 Property Line Installation Guidelines
- 2.2 Soldier Pile & Lagging
- 2.3 Metal Sheet Piling Retaining Wall
- 2.4 Earth Formed Shotcrete Retention
- 2.5 Auger Cast Caisson Retention Wall

SECTION 3: BACKFILLED WALLS

- 3.1 Surface Preparation
- 3.2 Installation
- 3.3 Backfilled Wall Penetrations
- 3.4 Terminations
- 3.5 Masonry Block Walls

SECTION 4: SPECIAL CONDITIONS

- 4.1 Precast Concrete Construction
- 4.2 Contaminated Conditions

THIS MANUAL CONTAINS THE INSTALLATION GUIDELINES FOR THE VOLTEX AND VOLTEX DS WATERPROOFING SYSTEM FOR CAST-IN-PLACE CONCRETE APPLICATIONS, INCLUDING UNDERSLAB, PROPERTY LINE WALLS, AND BACKFILLED WALLS. THIS MANUAL DOES NOT COVER SHOTCRETE, MASONRY BLOCK, OR PRECAST CONCRETE APPLICATIONS. FOR APPLICATIONS NOT COVERED IN THIS MANUAL, CONTACT CETCO FOR SPECIFIC INSTALLATION GUIDELINES. BEFORE INSTALLATION, READ THIS MANUAL TO GAIN FAMILIARITY WITH SPECIFIC PROCEDURES AND APPLICATIONS. IN THIS MANUAL THE PRODUCT NAME "VOLTEX" IS USED GENERICALLY FOR ALL VOLTEX PRODUCT TYPES.

WHAT IS SODIUM BENTONITE?

Sodium bentonite is a non-toxic mineral of volcanic origin found extensively in the Black Hills region of North America. Bentonite is specially processed by CETCO to achieve the highest possible performance for all of our waterproofing products. CETCO also manufactures a contaminant resistant bentonite to assure optimum performance in moderate saline or contaminated water.

Bentonite prevents water intrusion by forming a dense monolithic membrane upon contact with water. The specially processed bentonite expands under confinement, forming an impervious membrane that will be maintained for the life of the structure.

PRODUCT DESCRIPTION

VOLTEX is a highly effective waterproofing composite comprised of two polypropylene geotextiles and sodium bentonite. The two geotextiles are interlocked by a patented needlepunching process which encapsulates and confines the bentonite. VOLTEX DS® integrates a polymer liner bonded to the outside surface of the nonwoven geotextile. The polymer liner provides extremely low permeabilities for water vapor transmission.

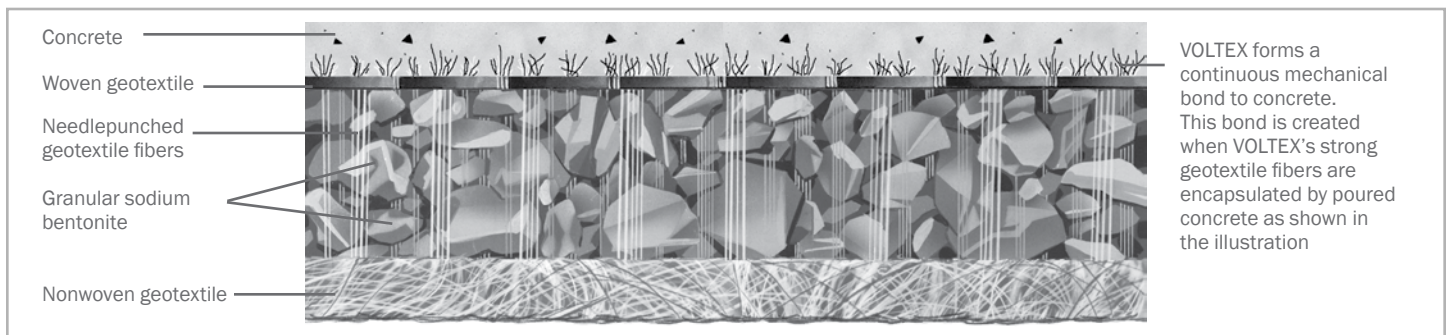

Figure 1 – Cross section illustration of VOLTEX waterproofing membrane mechanically bonded to concrete

Installation of VOLTEX is fast and easy. Simply position the product into place and fasten. VOLTEX can be installed on green concrete, in virtually any weather, without the need for primers or adhesives. VOLTEX can be easily cut on site to form around corners and penetrations. The result is always a consistent self-sealing membrane.

DURABILITY

The VOLCLAY® sodium bentonite in VOLTEX is uniformly encapsulated between two high-strength woven and non-woven geotextiles. CETCO's state-of-the-art needlepunching process interlocks the geotextiles, preventing the displacement of bentonite prior to, during, and after installation. The geotextiles provide superior protection from inclement weather and construction-related damage, without requiring to use a protection course.

SUPERIOR ADHESION

When concrete is poured against VOLTEX, a tenacious mechanical bond is created with VOLTEX's high strength geotextile. Independent laboratory testing conducted in accordance with ASTM D903 (mod.) (Peel Adhesion to Concrete), yields an average adhesion value of 2.6 kN/m (15 lbs/in). The mechanical bond will hold VOLTEX in intimate contact with the concrete should any ground settlement occur, thereby preventing water migration between the waterproofing and the concrete.

COST EFFECTIVE AND TIME EFFICIENT

VOLTEX is designed to be installed on a properly prepared subgrade, without the need to pour a working slab. The product's inherent flexibility allows for easy installation on irregular surfaces and rough property line forming. VOLTEX can be installed as soon as the forms are stripped; there is no waiting for the concrete to cure.

ASSOCIATED SYSTEM PRODUCTS

WATERSTOP-RX® – expanding concrete joint waterstop used around penetrations and applicable concrete joints. Swells upon hydration.

AQUADRAIN® – foundation drainage composite consisting of a molded profile core and a filter fabric. Includes sheet drainage and base drain collection.

ACCESSORIES

BENTOSEAL® – trowel grade mastic used to detail around penetrations, corner transitions and terminations.

CETSEAL – single-component polyether general sealant and adhesive.

HYDROBAR TUBES® – water soluble film tubing filled with active granular material.

WATERSTOPPAGE® – active granular material used at detail areas that require additional protection.

SEAMTAPE® – premium tape used to seal overlapped membrane edges of VOLTEX DS.

AKWASWELL® – caulk grade hydrophilic waterstop.

TERMINATION BAR – Min. 25 mm (1") wide aluminum or stainless steel bar with pre-punched holes on 300 mm (12") centering for fastening.

CEMENTITIOUS BOARD – 12 mm (1/2") thick cementitious wall board for protection of waterproofing during the removal of steel soldier pile cap and top lagging boards.

ENVIROSHEET – self-adhering flashing membrane used for grade and thru-wall flashing.

TB-BOOT – pre-formed, single piece cover for tie-back heads and soil nails. Three sizes available: TB-6SN, TB-8 & TB-10.

LIMITATIONS

VOLTEX should only be installed after substrate preparation has been properly completed and is suitable to receive the waterproofing system. Concrete work should use conventional cast-in-place forms that produce a smooth surface. Do not use stay-in-place concrete forming; use removeable forming products only.

VOLTEX is designed for below-grade waterproofing applications where the product is properly confined. VOLTEX products should not be installed in standing water or over ice. If ground water contains strong acids, alkalies, or is of a conductivity of 2,500 µmhos/cm or greater, water samples should be submitted to the manufacturer for compatibility testing. Ultraseal may be required if contaminated ground water or saltwater conditions exist.

VOLTEX is designed for use under reinforced concrete slabs 100 mm (4") thick or greater on a compacted earth/gravel substrate. VOLTEX requires a minimum 150 mm (6") thick reinforced concrete slab if installed over a mud slab. VOLTEX is not designed for split-slab plaza deck construction.

VOLTEX is not designed to waterproof expansion joints. Do not use VOLTEX on masonry block foundation walls. Consult CETCO for special installation guidelines that apply to shotcrete and precast concrete construction.

In this manual, the product name "VOLTEX" is used generically in the installation and application guidelines for the applicable products: VOLTEX, VOLTEX CR, VOLTEX DS and VOLTEX DSCR. Refer to the table on the back page for product descriptions and roll sizes. Illustrations are not shown to scale.

VOLTEX® & VOLTEX® DS BENTONITE GEOTEXTILE WATERPROOFING FOR CAST-IN-PLACE CONCRETE APPLICATIONS

INSTALLATION GUIDELINES

Before installing VOLTEX read this installation manual to gain familiarity with specific procedures and applications. For applications not covered in this manual, contact CETCO for specific installation guidelines.

SECTION 1 UNDERSLAB INSTALLATION

VOLTEX is engineered for use under reinforced concrete slabs 100 mm (4") thick or greater on a compacted earth/gravel substrate. VOLTEX requires a minimum 150 mm (6") thick reinforced concrete slab if installed over a mud slab. VOLTEX CR or VOLTEX DSCR is used in contaminated conditions as determined by a CETCO water sample test.

For hydrostatic conditions, VOLTEX should be installed under footings and grade beams as shown in Figures 1.6, 1.7 and 1.8. For non-hydrostatic conditions, VOLTEX should be installed around footings and grade beams as shown in Figures 1.9, 1.10 and 1.11.

Prior to installing VOLTEX the substrate must be properly prepared. Complete all required elevator pit, sump pit, grade beam and piling work prior to installing VOLTEX under main slab area. These areas must be correctly tied into the underslab waterproofing to form a monolithic seal.

1.1 SUBSTRATE PREPARATION

Substrate may be concrete, earth, sand, or crushed stone. Earth and sand substrates should be compacted to a minimum 85% Modified Proctor density. Crushed stone should be no larger than 19 mm (3/4") in size. Substrate should be smooth and without sharp deflections or pockets.

1.2 INSTALLATION

Install VOLTEX or VOLTEX DS over the properly prepared substrate with the dark gray (woven) geotextile side up. Overlap all adjoining edges a minimum of 100 mm (4") and stagger sheet ends a minimum of 300 mm (12") (Figure 1.1). Nail or staple edges together as required to prevent any displacement before and during concrete placement (Figure 1.2).

When the slab is poured in sections, VOLTEX should extend a minimum 300 mm (12") beyond the slab edge (Figure 1.3). This enables VOLTEX to be properly overlapped for subsequent slab section pours. WATERSTOP-RX should be installed in all applicable slab construction joints (Figure 1.3).

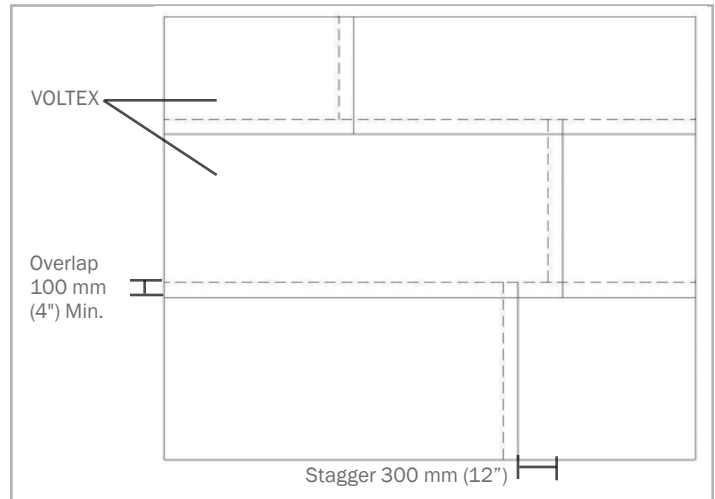

Figure 1.1 – Overlap edges 100 mm (4") with seams staggered 300 mm (12")



Figure 1.2 – Secure overlaps together with fasteners

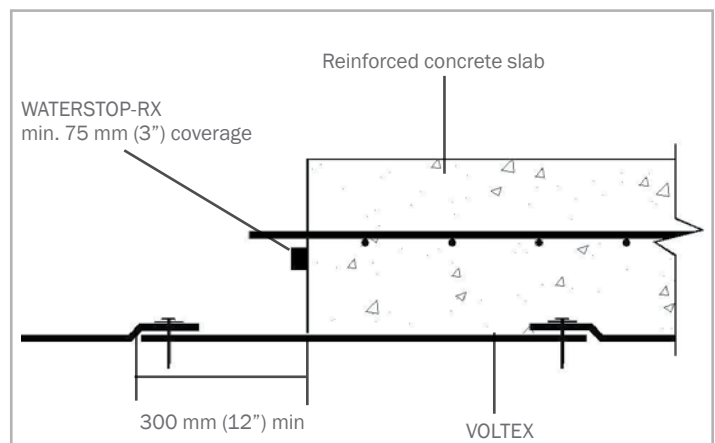

Figure 1.3 – Extend VOLTEX a minimum 300 mm (12") beyond slab edge. Install WATERSTOP-RX in joint

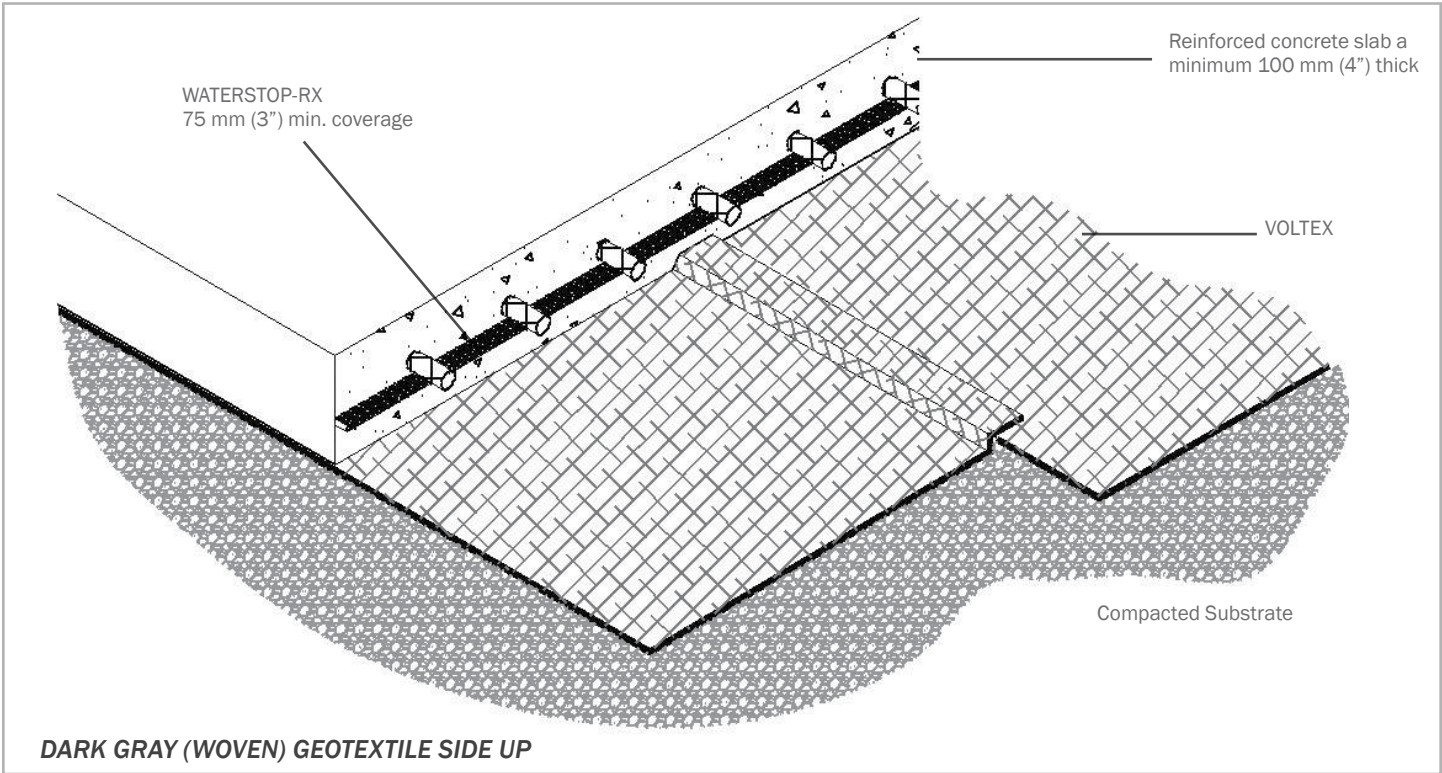

Figure 1.4 - VOLTEX installed directly over compacted earth/gravel substrate requires a minimum 100 mm (4") slab

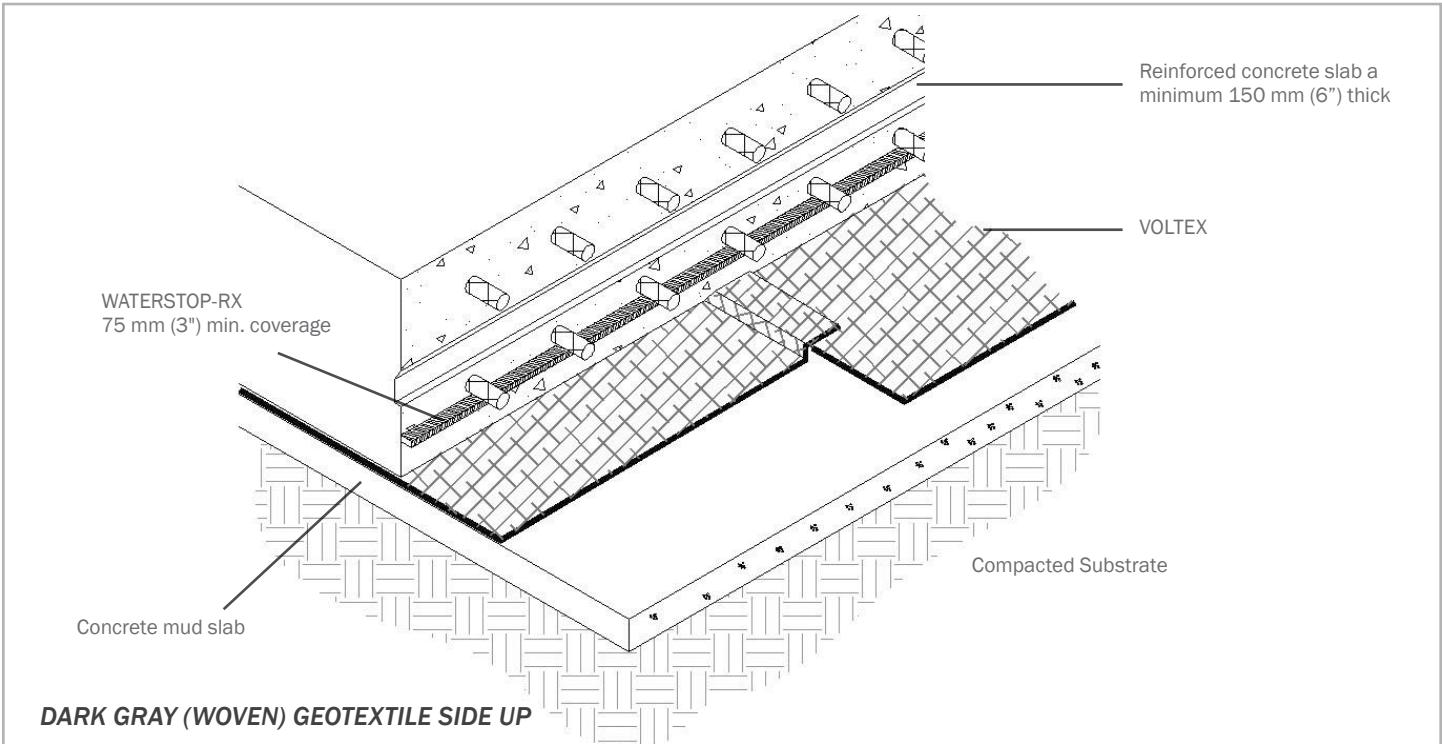

Figure 1.5 - VOLTEX installed over a mud slab requires a minimum 150 mm (6") thick reinforced slab

VOLTEX® & VOLTEX® DS

BENTONITE GEOTEXTILE WATERPROOFING FOR CAST-IN-PLACE CONCRETE APPLICATIONS

HYDROSTATIC CONDITIONS

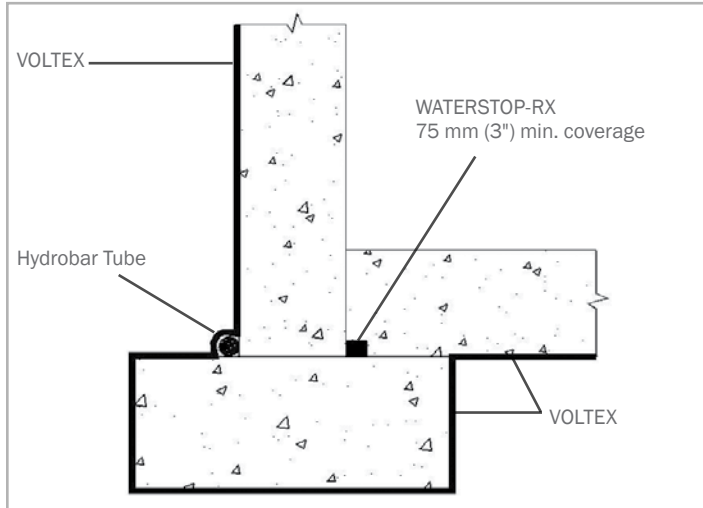

Figure 1.6 – Slab on footing detail (hydrostatic)

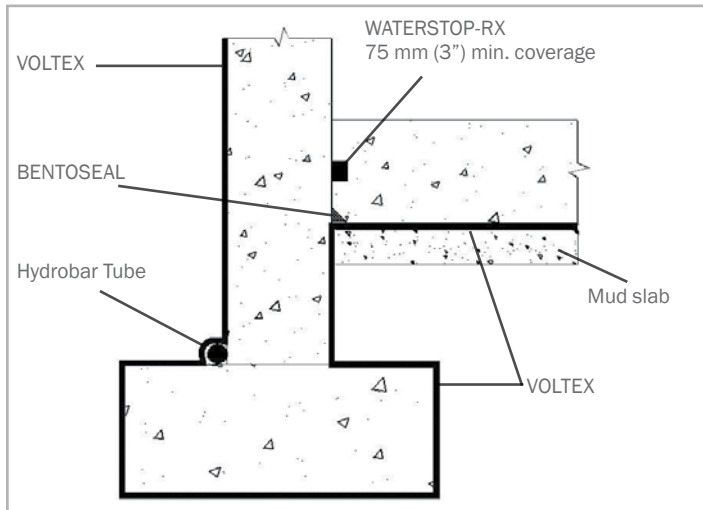

Figure 1.7 – Raised slab detail with mud slab (hydrostatic)

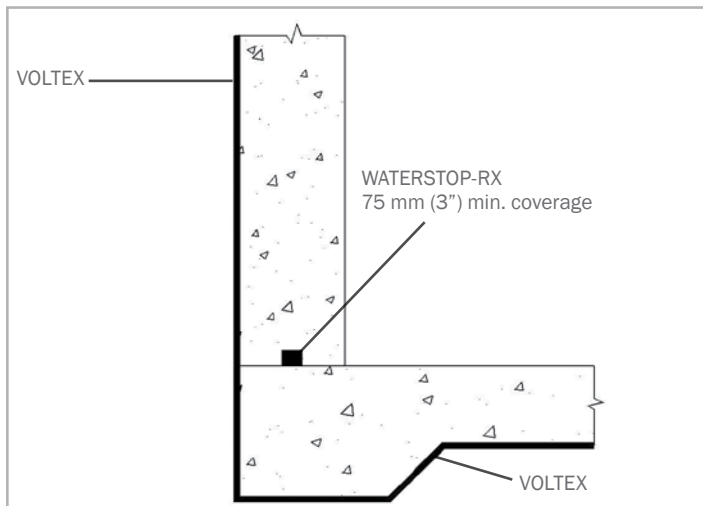

Figure 1.8 – Flush slab detail property line wall (hydrostatic)

NON-HYDROSTATIC CONDITIONS

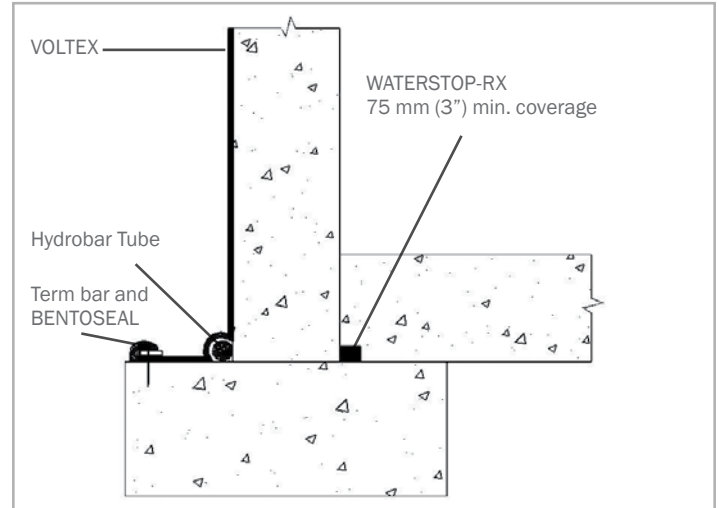

Figure 1.9 – Slab on footing detail (non-hydrostatic)

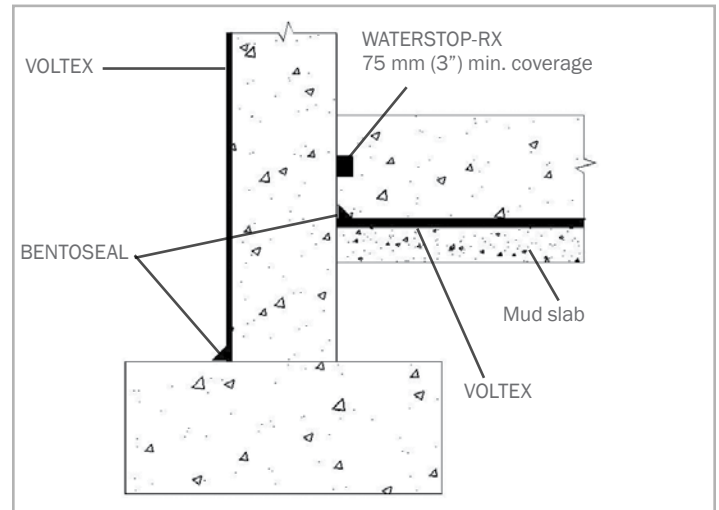

Figure 1.10 – Raised slab detail with mud slab (non-hydrostatic)

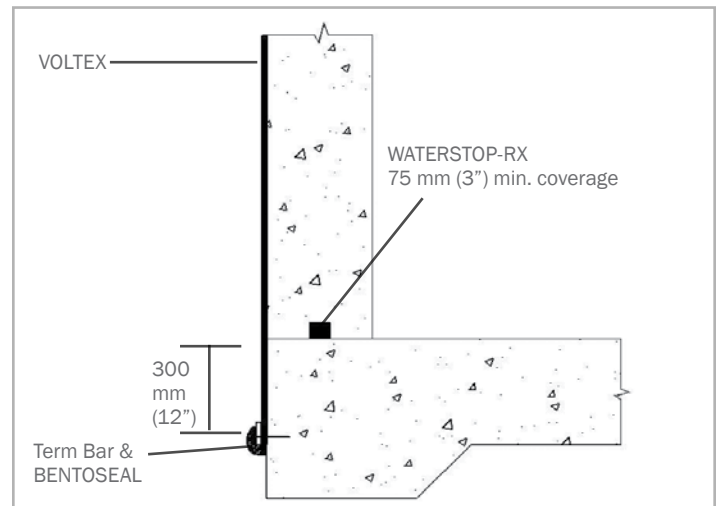

Figure 1.11 – Flush slab detail backfilled wall (non-hydrostatic)

1.3 PILE CAPS AND GRADE BEAMS

VOLTEX is typically not installed over pile caps but cut to fit tightly around pile caps. Then apply a minimum 19 mm (3/4") thick fillet of BENTOSEAL at intersection of VOLTEX and the piling (Figure 1.12) with Waterstoppage under VOLTEX at the piling edge. BENTOSEAL should extend onto VOLTEX and piling a minimum of 50 mm (2") at 19 mm (3/4") thickness. WATERSTOP-RX should be installed on top surface of pile cap around reinforcing steel (Figure 1.12).

Detail grade beams the same as pile caps (Figure 1.14) with a non-hydrostatic condition. For hydrostatic conditions, VOLTEX should be installed under the entire grade beam (Figure 1.15). Line the grade beam formwork with VOLTEX prior to placement of reinforcing steel. Leave a minimum 300 mm (12") of VOLTEX at the top of the form to tie into below slab waterproofing.

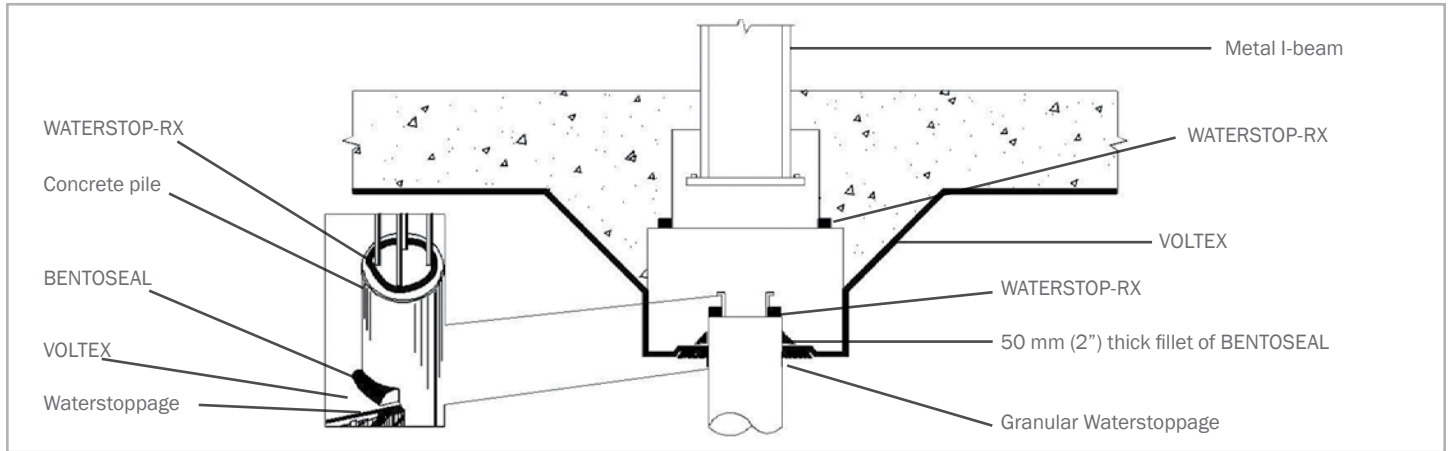

Figure 1.12 – Pile Cap Detail (Hydrostatic condition)

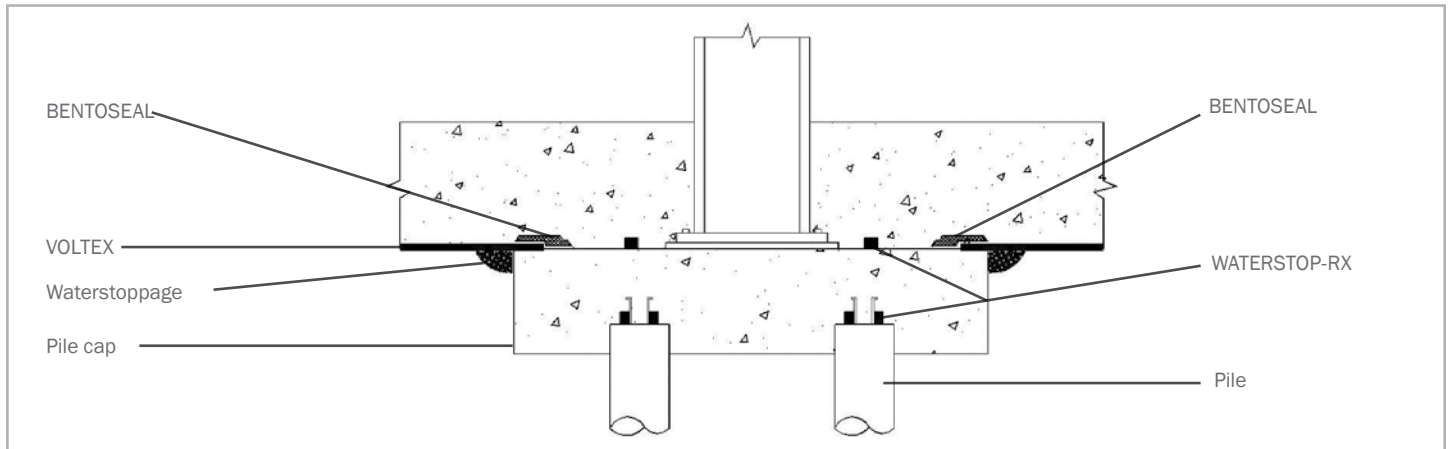

Figure 1.13 – Pile Cap Detail (Non-hydrostatic condition)

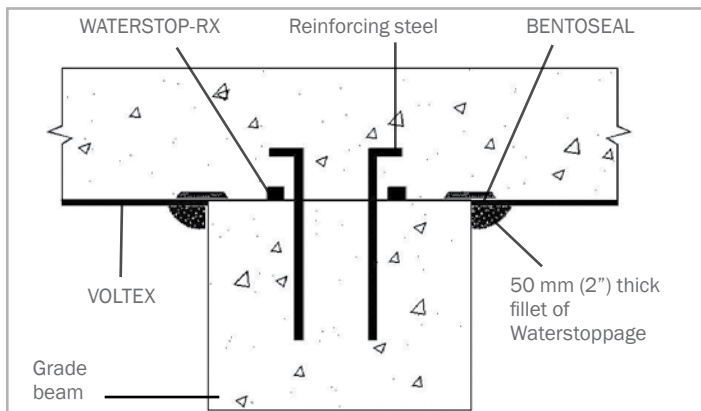

Figure 1.14 – Grade Beam (Non-hydrostatic condition)

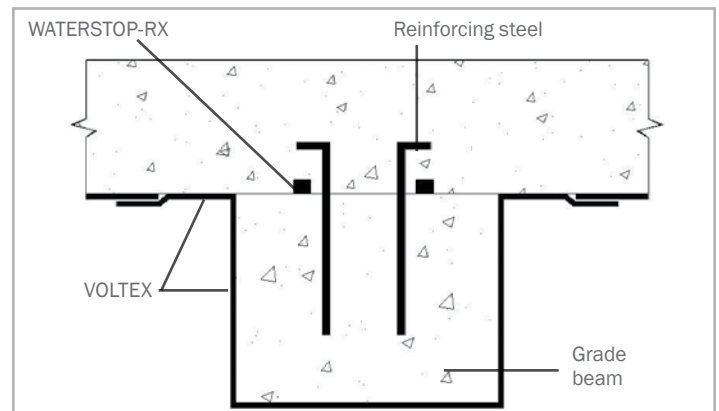

Figure 1.15 – Grade Beam (Hydrostatic condition)

VOLTEX® & VOLTEX® DS
BENTONITE GEOTEXTILE WATERPROOFING FOR CAST-IN-PLACE CONCRETE APPLICATIONS

1.4 SLAB PENETRATIONS

Cut VOLTEX to closely fit around penetrations (Figure 1.16). Trowel a minimum 19 mm (3/4") thick fillet of BENTOSEAL around the penetration to completely fill any void area between VOLTEX and the penetration (Figure 1.17). The BENTOSEAL should extend up the penetration about 38 mm (1-1/2") and extend onto VOLTEX. In areas where multiple penetrations are close together, it may be impractical to cut VOLTEX

to fit around each penetration. Pour Waterstoppage, granular bentonite, a minimum 6 mm (1/4") thick around the penetrations covering the entire substrate area. With gravel substrate, install minimum 200 mm (8") collar of VOLTEX around penetration prior to placing waterstoppage. Then apply a thick layer of BENTOSEAL around each penetration as detailed (Figure 1.19).

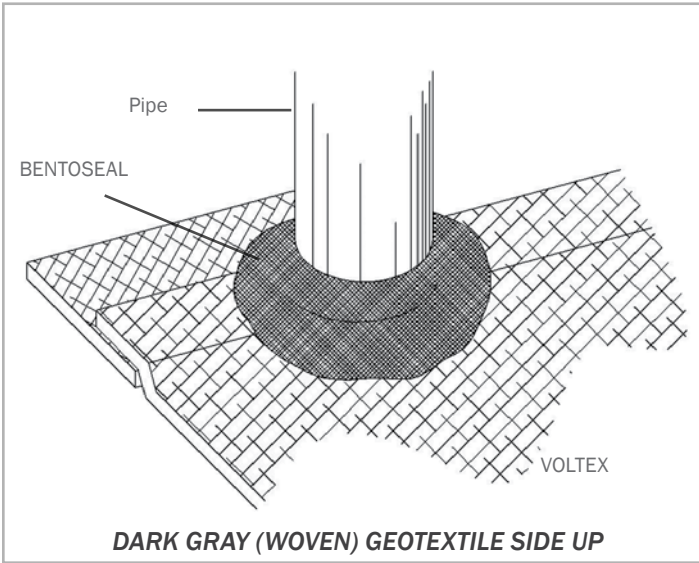

Figure 1.17 – BENTOSEAL troweled around penetrations

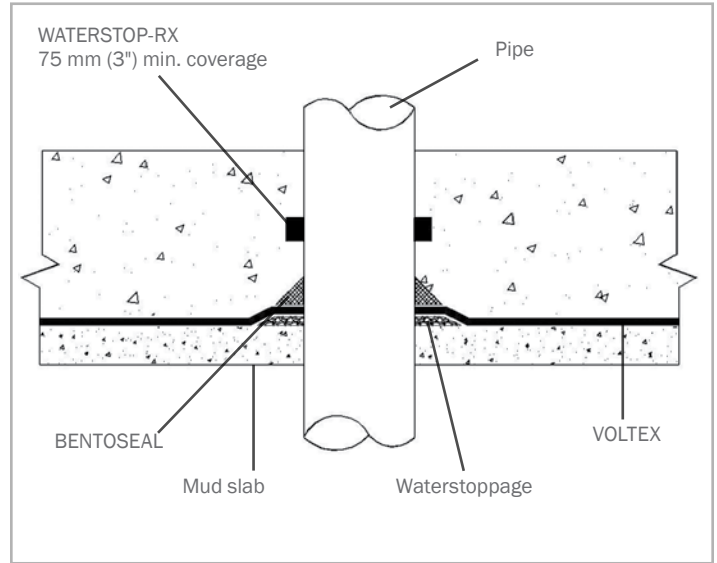

Figure 1.18 – Slab penetration cross section detail

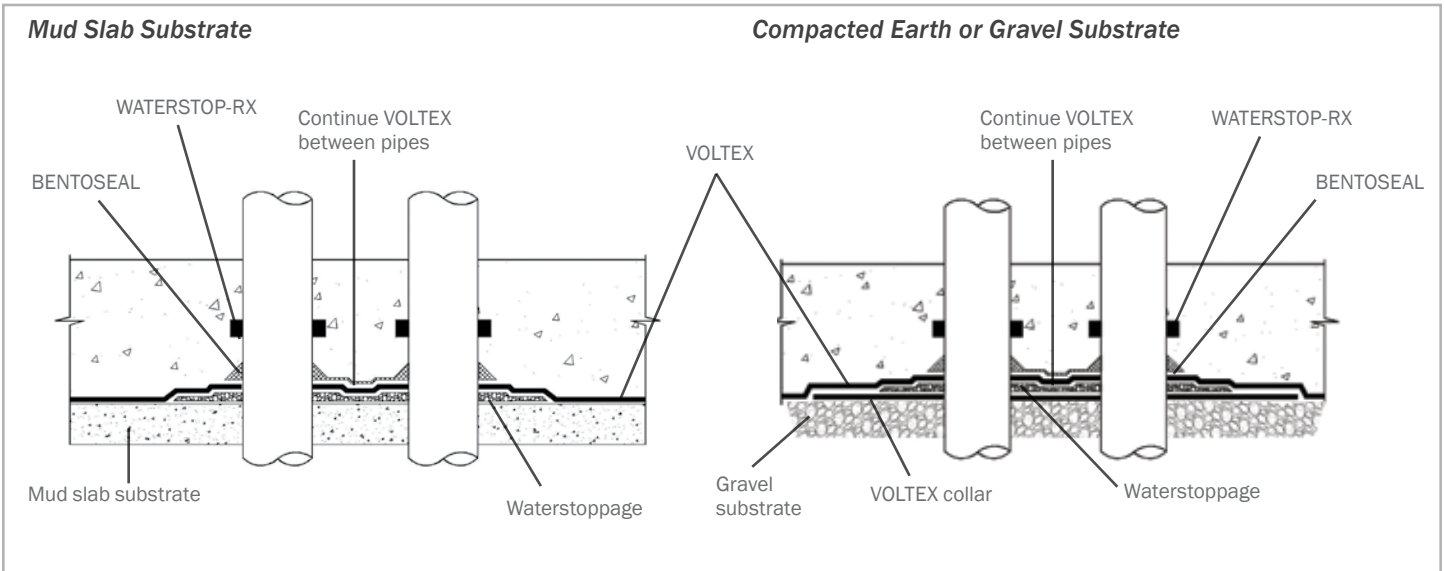

Figure 1.19 – Multiple pipe penetrations. Trowel BENTOSEAL around pipes and covering area between the pipes

1.5 ELEVATOR PITS

VOLTEX should be placed on vertical surfaces and on the substrate below the slab to form a continuous envelope around the elevator pit (Figure 1.20). If the vertical soil cut is smooth and stable, VOLTEX may be

installed directly against the soil. Contain unstable soils with a retaining wall. Install VOLTEX directly against the retaining wall. Due to various elevator piston plunger designs, consult CETCO for specific installation and detailing for piston plungers that penetrate the pit slab.

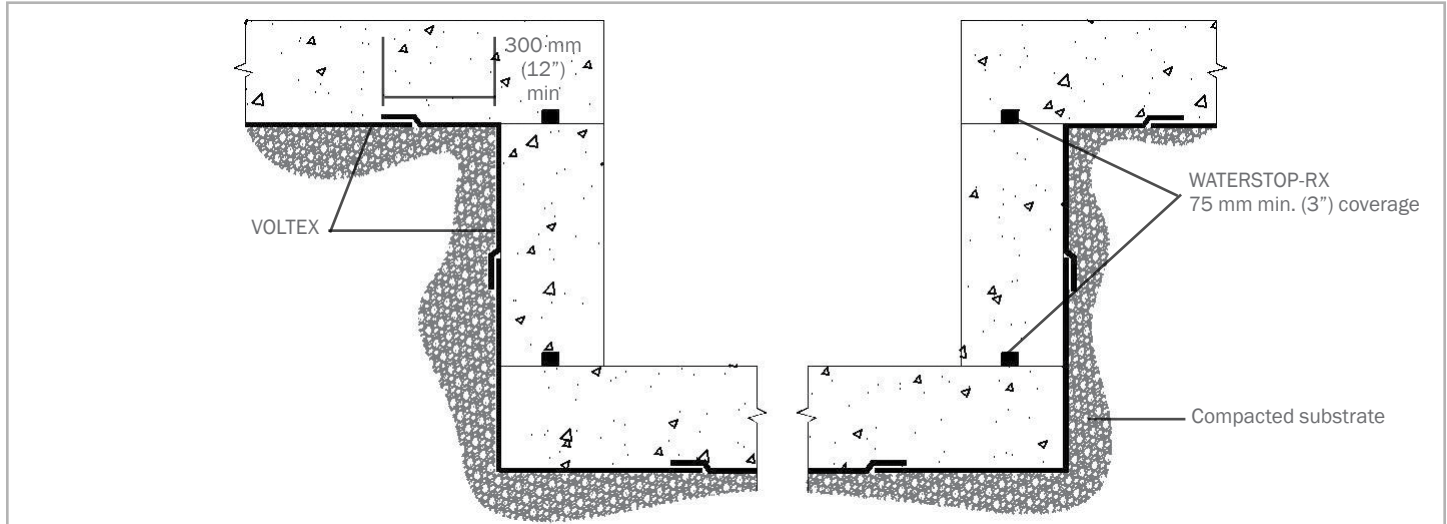

Figure 1.20 – VOLTEX under elevator pit slab and on excavation cut walls

1.6 EDGE OF SLAB, BACKFILLED WALLS

When the installation reaches the outer edge of the slab, continue VOLTEX up to the top edge of the forms inside surface (Figure 1.21) or extend the VOLTEX sheet out the top of the form a minimum of 300 mm (12") (Figure 1.22). At the slab corner, VOLTEX should remain in contact with the substrate and the inside surface of the concrete form.

When the slab edge form is removed, any undamaged portion of VOLTEX extended outside the form should be positioned and secured

to the top of the concrete footing. Damaged material outside the form should be cut off and disposed of. Overlap the secured VOLTEX edge on top of the footing a minimum 150 mm (6") with the succeeding wall waterproofing. Install Hydrobar Tubes at wall-to-footing corner prior to installing overlapping wall waterproofing.

WATERSTOP-RX should be installed in the perimeter wall/slab intersection joint as illustrated in Figure 1.23.

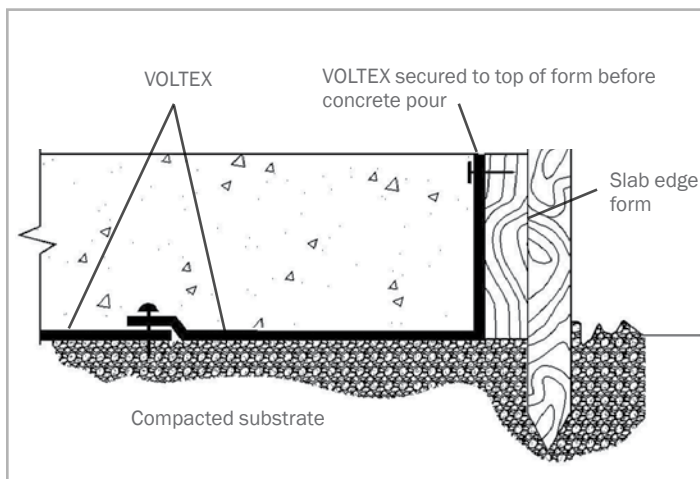

Figure 1.21 – VOLTEX turned up and secured at top of concrete form

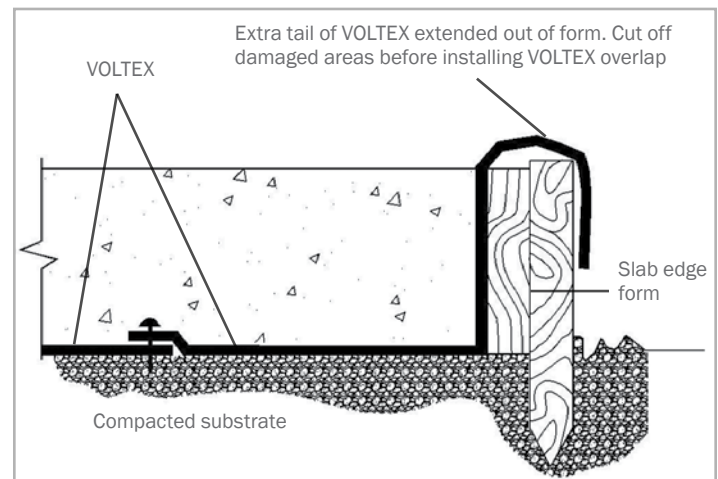

Figure 1.22 – Extra tail of VOLTEX extended out of form and later cut off after concrete pour

VOLTEX® & VOLTEX® DS BENTONITE GEOTEXTILE WATERPROOFING FOR CAST-IN-PLACE CONCRETE APPLICATIONS

1.7 EDGE OF SLAB, PROPERTY LINE CONSTRUCTION

Where property line retaining walls, such as soldier pile and lagging, are used as the outside form, continue the underslab VOLTEX installation up the retaining wall a minimum 300 mm (12") above the top edge of the slab or footing (Figure 1.23). The extra 300 mm (12") sheet extension is very important since there is no access to the outer edge of the footing after it is poured.

Slab to Wall Corner Transition: Install VOLTEX or VOLTEX DS sheet horizontally oriented (dark gray woven geotextile facing installer) with a minimum 300 mm (12") of the sheet extending out onto the horizontal substrate. The top edge of the sheet must extend a minimum 300 mm (12") above the finished slab surface. Secure VOLTEX sheet to lagging wall with washer-head fastener maximum 600 mm (24") on center. Overlap edges of adjacent VOLTEX sheets a minimum 100 mm (4").

If the slab thickness is greater than 600 mm (24"), install a second full sheet or cut strip of VOLTEX, horizontally oriented, to meet the 300 mm (12") requirement above the slab. Overlap top edge of previous sheet and edges of adjacent sheets a minimum 100 mm (4").

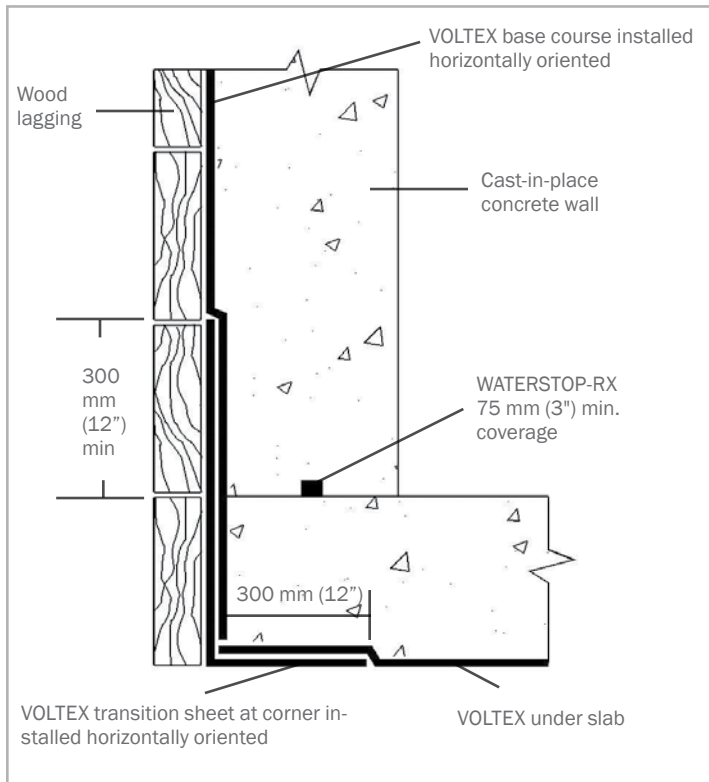

Figure 1.23 – SLAB-TO-WALL TRANSITION – VOLTEX corner transition sheet should extend past the height of the top of the finished slab level a minimum 300 mm (12") and extend under the slab 300 mm (12")

Base Wall Course: Install first VOLTEX sheet course on the shoring wall horizontally oriented (dark grey woven geotextile facing installer) over the corner transition sheet, with the bottom edge extending down to the wall/slab transition corner as shown in Figure 1.23. Secure VOLTEX sheet to lagging wall with washer-head fasteners maximum 600 mm (24") on center. Overlap edges of adjacent VOLTEX sheets a minimum 100 mm (4").

Install underslab VOLTEX membrane extending to corner transition, overlapping the 300 mm (12") sheet tail of the corner transition sheet installed at the wall base. Secure corner edge with fasteners 300 mm (12") on center.

For metal sheet piling shoring walls, first install the VOLTEX corner transition sheet horizontally oriented with the bottom edge extending minimum 300 mm (12") out onto the substrate. Cut the bottom edge of the corner transition sheet at piling transition angles to allow the bottom edge to lay flat onto the substrate. Pour 38 mm (1 1/2") continuous cant of Waterstoppage along base of shoring wall. Then install underslab VOLTEX sheet cut to fit contours of metal sheet piling. Finally, install the base shoring wall VOLTEX sheet (horizontally oriented) overlapping the corner transition sheet.

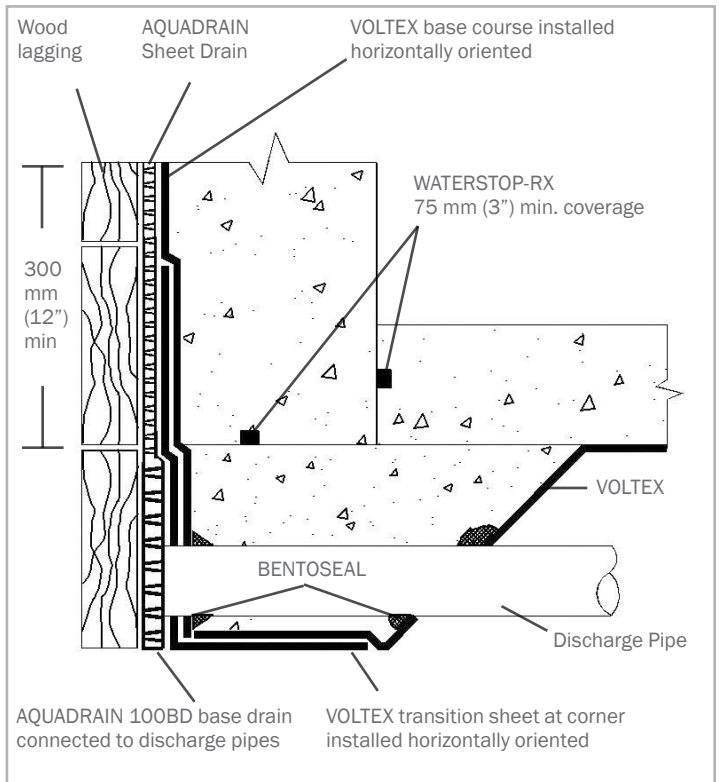

Figure 1.24 – AQUADRAIN 100BD DISCHARGE PIPE – Connect AQUADRAIN 100 BD to water discharge pipes using 100 BD accessory connections

SECTION 2 PROPERTY LINE CONSTRUCTION

The use of construction techniques described in this section allow the exterior building dimensions to coincide with the property line, thereby maximizing use of available land for building. VOLTEX/VOLTEX DS has been proven to be one of the most effective and widely used means for waterproofing property line construction. Cast-in-place property line construction methods include soldier pile & lagging, metal sheet piling, earth formed shotcrete retention walls, and auger cast caisson walls.

For all property line construction methods, VOLTEX is installed to the shoring wall prior to concrete placement. Install VOLTEX or VOLTEX DS with the dark grey (woven) geotextile inward, facing the installer, away from the shoring wall. Refer to each applicable construction method in Section 2 for specific substrate preparation and detailing installation guidelines.

AQUADRAIN sheet and 100BD base drain composite system should be connected to an operative water discharge system (sump pump or gravity to daylight discharge).

Protect bentonite waterproofing products from hydrating before material is contained with concrete or backfill. After any precipitation, standing water should be pumped off waterproofing as soon as possible.

Shoring Wall: Excavation work should provide shoring wall in good condition to receive waterproofing system. Wood lagging shoring should extend to the lowest level of the waterproofing installation with any voids or cavities exterior of the lagging filled with compacted soil or cementitious grout. Voids or cavities at tie-backs should be filled with grout or compacted soil prior to VOLTEX installation. Interior surface of lagging timbers should be monolithic and tight together with gaps less than 25 mm (1"). Gaps in excess of 25 mm (1") should be completely filled with cementitious grout or other solid material.

Cut rock excavations and concrete auger cast caisson retaining walls must be sufficiently planar. Typically a shotcrete or grout layer is required to provide acceptable surface to install VOLTEX.

Employ construction methods to stop water flowing through shoring wall prior to waterproofing installation. If only water seepage, install polyethylene sheeting over the seepage area prior to installing VOLTEX. Polyethylene sheeting should extend from seepage elevation to base of wall to protect entire waterproofing installation at that area.

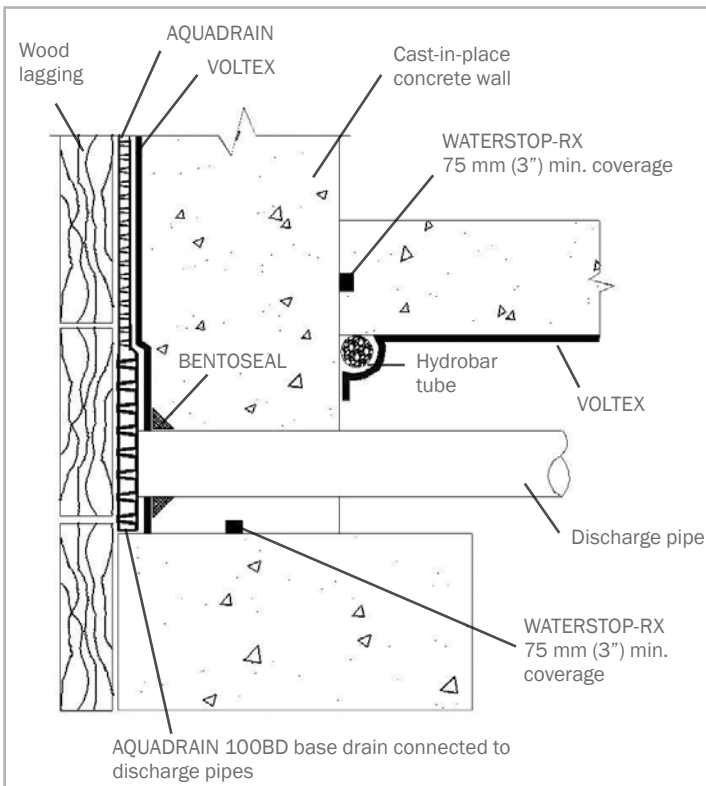

Figure 1.25 – RAISED SLAB CONDITION – Connect AQUADRAIN 100BD to water discharge pipes using 100BD accessory connectors

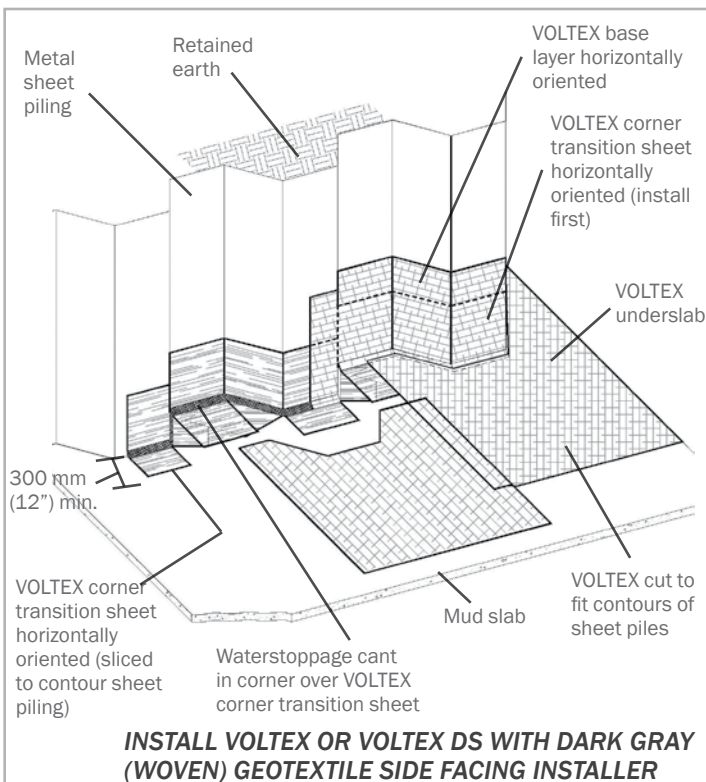

Figure 1.26 – Metal sheet piling to slab transition detail

VOLTEX® & VOLTEX® DS BENTONITE GEOTEXTILE WATERPROOFING FOR CAST-IN-PLACE CONCRETE APPLICATIONS

2.1 PROPERTY LINE WALL INSTALLATION

GUIDELINES

After the slab-to-wall corner transition sheet and bottom wall sheet course have been installed per Section 1.7 Page 10, VOLTEX sheets can be installed either vertically or horizontally oriented. Fasten the VOLTEX into position with washer-head fasteners maximum 600 mm (24") on center around the sheet edge. Install succeeding VOLTEX sheet overlapping the previous sheet edge 100 mm (4"). (Note: Shingle lap seams so that the bottom edge of the upper sheet is over the lower sheets top edge).

Continue installation up wall until grade detail, or as specified, staggering all sheet ends of adjacent rolls a minimum 300 mm (12"). Do not allow sheet overlap joints to occur at same elevation as concrete cold joints. Plan by chalk lining the location of construction joints.

Penetrations: Install a cut collar of VOLTEX tightly around the penetration; extending a minimum 300 mm (12") radius. Apply BENTOSEAL over VOLTEX collar around penetration; extending BENTOSEAL a minimum 75 mm (3") radius at 6 mm (1/4") thickness. Then install main course of VOLTEX membrane tightly around the penetration. Finally, detail around penetration with 19 mm (3/4") thick cant of BENTOSEAL. With sleeved pipes, the concrete work should include filling the gap between the pipe and the sleeve with non-shrink cementitious grout, mechanical seal by others and install WATERSTOP-RX to outside of sleeve.

Tie-Back Covers: Select appropriate size TB-Boot to fit over tie-back plate and allow proper cast-in-place concrete coverage per project requirements. TB-Boot should fit over entire tie-back head without the tie-back plate or cables in direct contact with the TB-Boot. Prior to TB-Boot installation, fill voids in retention wall substrate and tie-back head assembly with spray foam (min 20 psi) or non-shrink grout. For non-hydrostatic conditions, install and secure AQUADRAIN drainage composite course per manufacturer's guidelines to soil retention wall prior to installing TB-Boot. For hydrostatic conditions, install TB-Boot prior to VOLTEX membrane. With soldier piles, strip piles with waterproofing membrane prior to TB-Boot placement.

Fill pre-formed shape of TB-Boot with 2-part urethane spray foam (min 20 PSI) and place over tie-back head before foam sets up. Secure TB-Boot to soil retention system using washer head fasteners along the outside edge of the flat base. Apply 6 mm (1/4") thick by minimum 75 mm (3") wide continuous ring of BENTOSEAL onto the flat base just outside of the 12 mm (1/2") raised collar. Install 4-ft by 4-ft piece of VOLTEX (with pre-cut hole in center to fit tight around the 12 mm (1/2") raised collar) over the entire flat base with outside edges fastened to the retaining wall. Secure inside VOLTEX edge around raised collar with washer-head fasteners that pass through the BENTOSEAL ring; typical fastener spacing 150 mm (6"). Do not install fasteners or puncture TB-Boot inside of the 12 mm (1/2") raised collar. Apply counter flashing of BENTOSEAL along VOLTEX sheet edge around raised collar. Then install VOLTEX field sheet overlapping outer membrane edge minimum 100 mm (4").

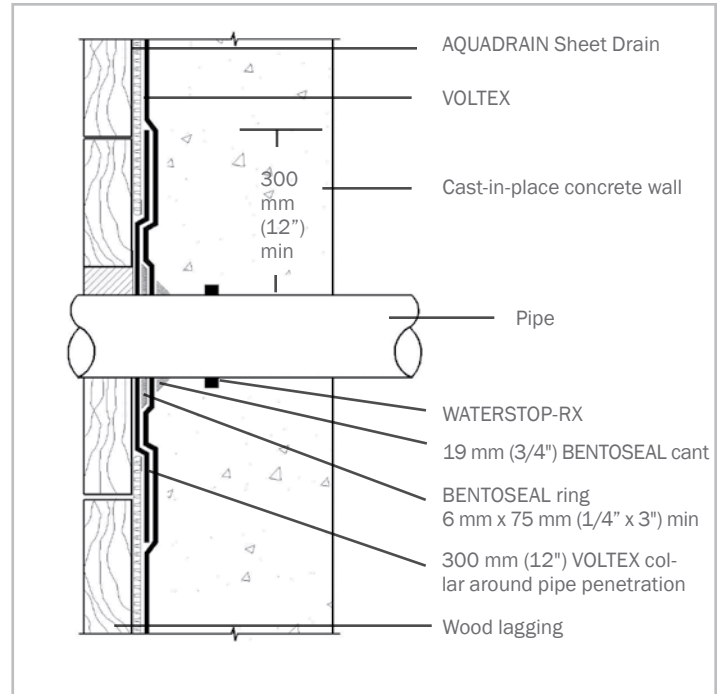

Figure 2.1 - WALL PENETRATION - Cut and secure VOLTEX tightly around penetrations and then apply BENTOSEAL 19 mm (3/4") ring around penetration and extend over membrane a minimum 75 mm (3") radius at minimum 6 mm (1/4") thickness

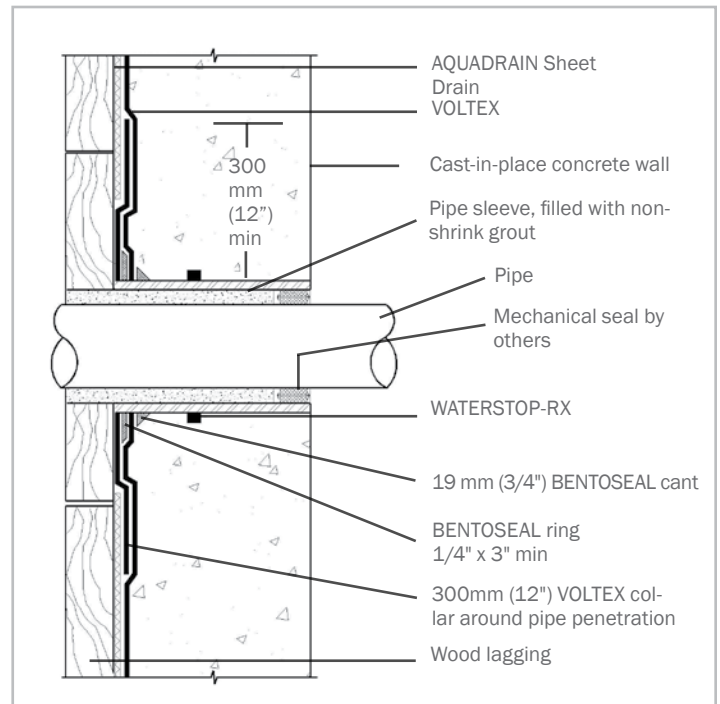

Figure 2.2 - SLEEVED WALL PENETRATION - Cut and secure VOLTEX tightly around penetrations and then apply BENTOSEAL 19 mm (3/4") ring around penetration and extend over membrane a min. 75 mm (3")

NON-HYDROSTATIC CONDITIONS

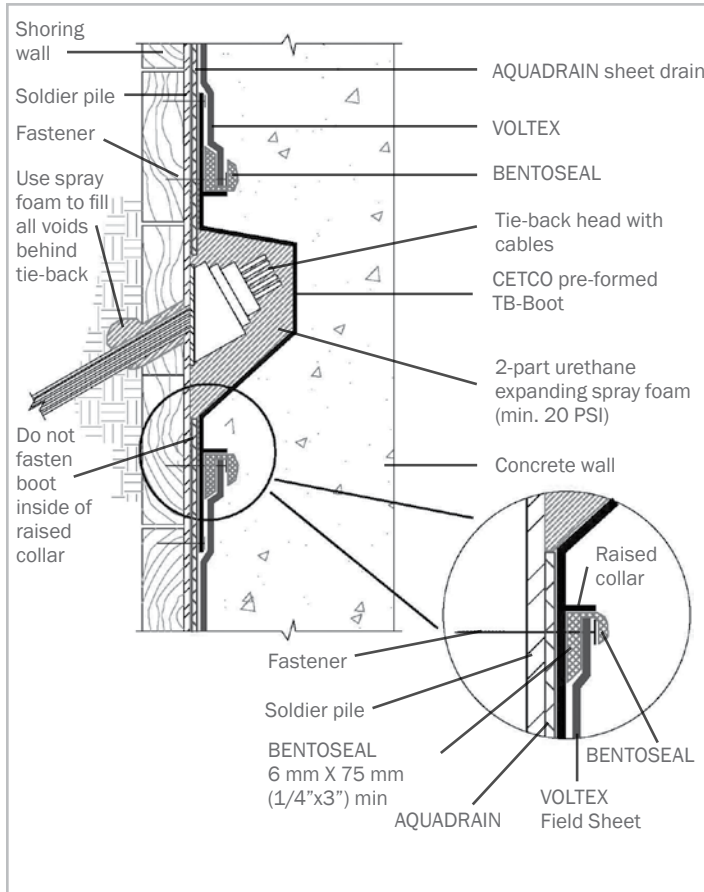

Figure 2.3: TIE-BACK DETAIL – Install TB-Boot centered over tie-back then install main course of VOLTEX with BENTOSEAL detailing. Do not fasten boot inside of raised collar around center formed area

HYDROSTATIC CONDITIONS

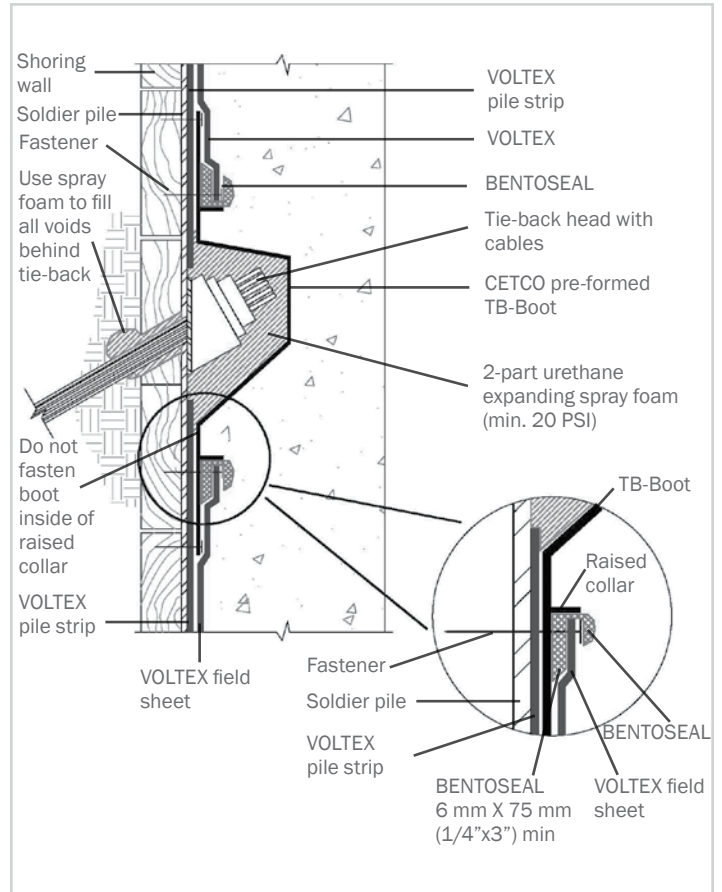

Figure 2.3a: TIE-BACK DETAIL – Install TB-Boot centered over tie-back then install VOLTEX with BENTOSEAL detailing. Do not fasten boot inside of raised collar around center formed area

Soldier Pile Stripping: Install a strip of VOLTEX over all soldier piles with raised lagging hanger bolts, form tie rods, or other irregular surface. VOLTEX strip should extend a minimum 150 mm (6") to both sides of the piling. Apply BENTOSEAL 6 mm x 50 mm (1/4" x 2") to VOLTEX strip surface along both edges of each soldier pile (Figure 2.9).

Cementitious Board: Prior to installing VOLTEX/VOLTEX DS to finished grade, install 12 mm (1/2") thick cementitious wall board centered over steel soldier pile from finished grade elevation to specified depth that the top of steel soldier pile and wood lagging will be removed (Figure 2.13).

Grade Termination: Terminate VOLTEX membrane 300 mm (12") below finished grade elevation with washer-head fasteners maximum 300 mm (12") on center. Install ENVIROSHEET flashing to primed concrete substrate with bottom edge overlapping top edge of VOLTEX membrane minimum 100 mm (4"). Overlap all roll ends a minimum 100 mm (4") to form a continuous flashing. Height of flashing shall be per project details and specifications. Install a rigid termination bar along top edge of

ENVIROSHEET; fastened maximum 300mm (12") on center. Complete grade termination detail with tooled bead of CETSEAL along the top edge, at all penetrations through the flashing, and all exposed overlap seams.

Where lagging timbers and the top end of steel soldier piles are removed, repair any waterproofing damaged by the excavation and removal of the retention wall system. Secure all excavated VOLTEX overlap seams with washer-head fasteners maximum 600 mm (24") on center; with VOLTEX DS also apply Seamtape centered along overlap seams. Backfill shall be placed and compacted to minimum 85% Modified Proctor density promptly after waterproofing installation. Backfill should consist of compactable soil or angular aggregate 19 mm (3/4") or less) free of debris, sharp objects, and stones larger than 19 mm (3/4"). See termination details figures 3.11 and 3.12, page 22.

VOLTEX® & VOLTEX® DS
BENTONITE GEOTEXTILE WATERPROOFING FOR CAST-IN-PLACE CONCRETE APPLICATIONS

2.2 SOLDIER PILE & LAGGING RETAINING WALL

Verify the following substrate preparation work has been completed. Then install VOLTEX following the property line installation guidelines in Section 2.1 on page 12 and 13.

Preparation: Gaps between the wood lagging must be no wider than 25 mm (1"). If the gaps between lagging are in excess of 25 mm (1"), the gaps should be completely filled with cementitious grout, wood, extruded polystyrene (40 psi min.) or compacted soil (Figure 2.7). If water is flowing through the lagging, a thin polyethylene sheeting can be installed over the area before VOLTEX is installed.

In areas with large gaps (up to 63 mm [2-1/2"]) between lagging, AQUADRAIN sheet drainage composite can be installed over the lagging to provide a uniform surface to mount VOLTEX (Figure 2.8). Securely fasten AQUADRAIN to the lagging surface with washerhead nails before installing VOLTEX. Gaps larger than 63 mm (2-1/2") between lagging should be completely filled with grout, wood, extruded polystyrene (40 psi min.) or compacted soil even if AQUADRAIN is installed prior to VOLTEX. Do not use plywood or other surface treatment over large lagging gaps that leaves the cavity void. Details 2.10 through 2.12 on page 15 illustrate the installation of VOLTEX over the different wood lagging positions relative to the soldier piling.

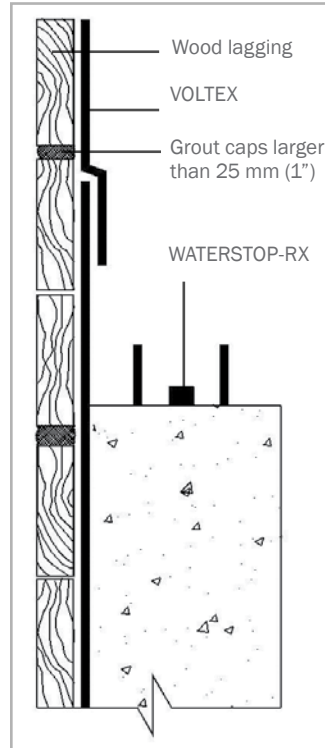

Figure 2.7 – VOLTEX installed directly to wood lagging with gaps filled. (Cast-in-place concrete wall)

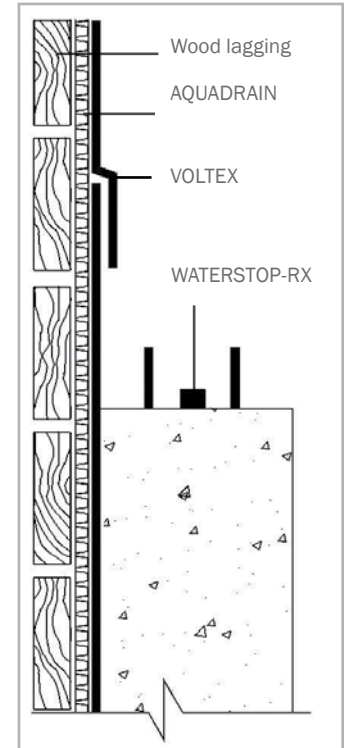
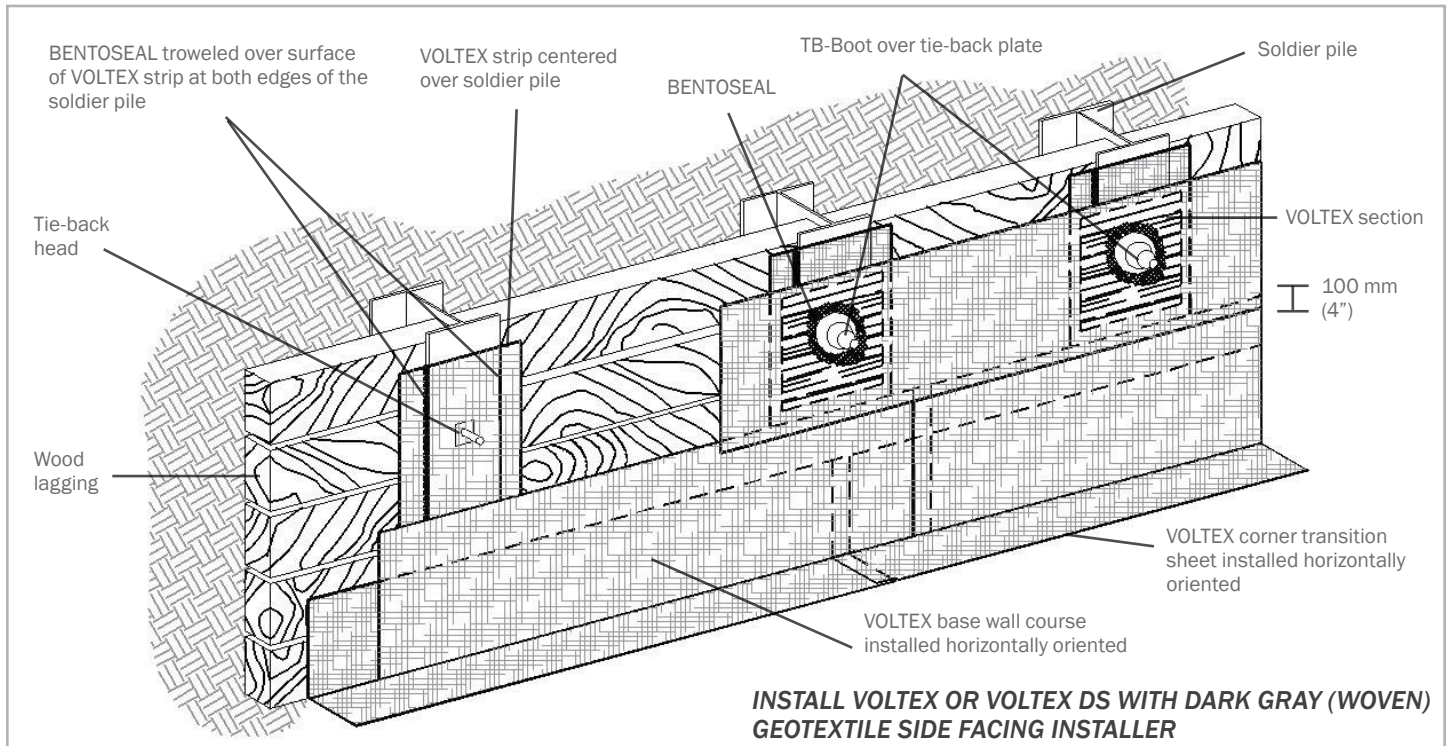

Figure 2.8 – AQUADRAIN used to cover gaps in lagging less than 63 mm (2.5"). (Cast-in-place concrete wall)



INSTALL VOLTEX OR VOLTEX DS WITH DARK GRAY (WOVEN) GEOTEXTILE SIDE FACING INSTALLER

Figure 2.9 – Install VOLTEX onto soldier pile and wood lagging retaining wall prior to cast-in-place concrete wall

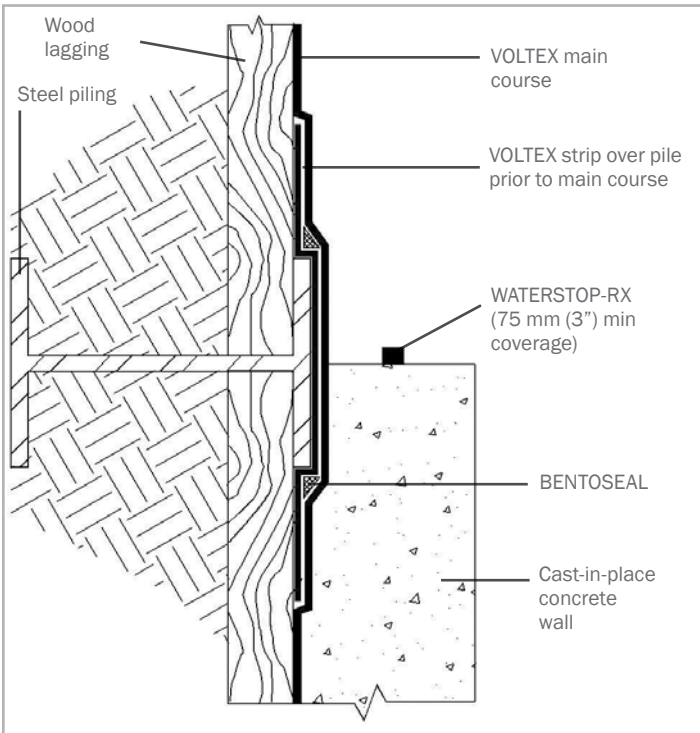

Figure 2.10 – Lagging secured to outside surface of front pile flange providing smooth surface (Plan View)

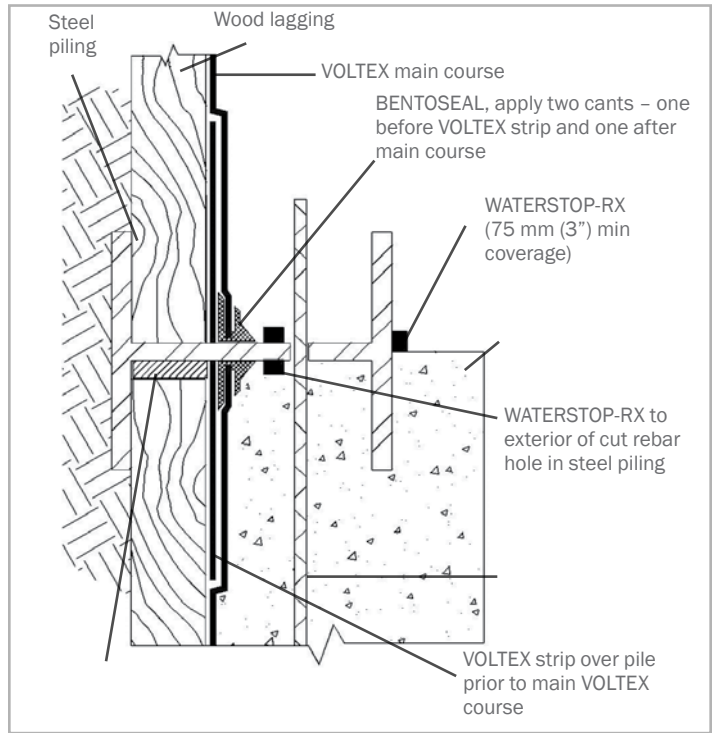

Figure 2.12 – Lagging secured to inside surface of back pile flange. Install BENTOSEAL and VOLTEX strip prior to main VOLTEX course and inward BENTOSEAL cant. (Plan View)

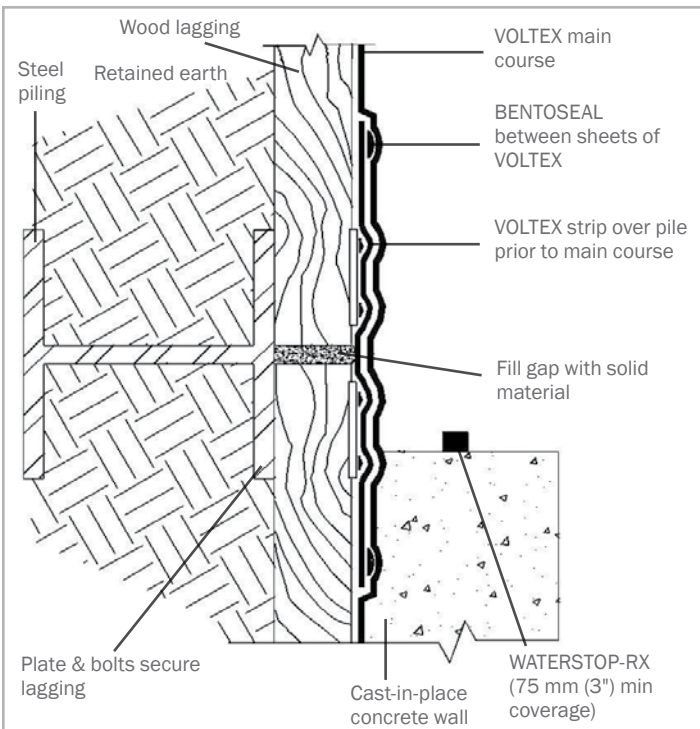

Figure 2.11 – Lagging secured to inside surface of front pile flange. Install VOLTEX strip to cover mounting plates and bolts prior to main course (Plan View)

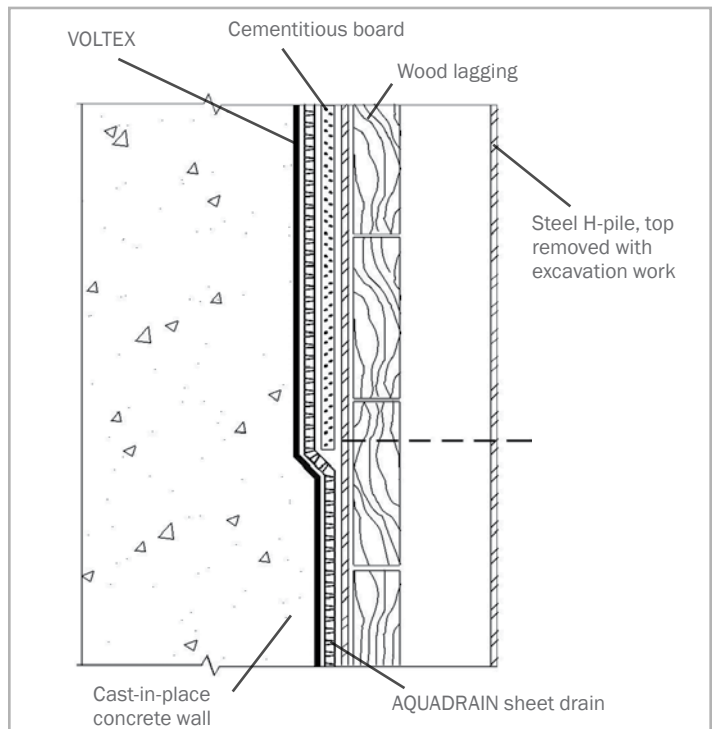

Figure 2.13 – WALL EXCAVATION AT GRADE – Cementitious board protects waterproofing during excavation and removal of steel pile top and wood lagging

VOLTEX® & VOLTEX® DS BENTONITE GEOTEXTILE WATERPROOFING FOR CAST-IN-PLACE CONCRETE APPLICATIONS

2.3 METAL SHEET PILING RETAINING WALL

Verify the following substrate preparation work has been completed. Then install VOLTEX following the property line installation guidelines in Section 2.1 on page 12 and 13. Special knurled powder-actuated fasteners are recommended to secure VOLTEX to the metal sheet piling.

Preparation: Trowel a 12 mm (1/2") thick layer of BENTOSEAL along all sheet piling knuckles. Fill voids or cavities at tieback plates with cementitious grout or compacted soils. If excessive water is penetrating the sheet piling knuckles, BentogROUT can be injected to the outside of the knuckle to stop water flow (Figure 2.14). Consult CETCO for BentogROUT applications and installation guidelines.

Alternate Plywood Method

Alternatively, 12 mm (1/2") plywood may be fastened to the sheet piling to create a flat surface upon which VOLTEX is fastened. All void spaces between the plywood and sheet piling must be filled with compacted earth or concrete. Apply VOLTEX to plywood following "Property Line Construction" Guidelines in Section 2, Page 11.

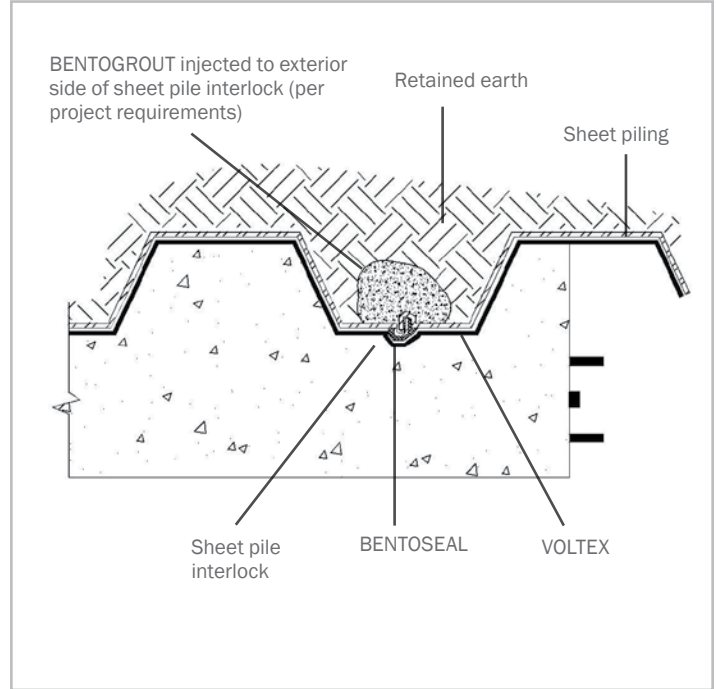
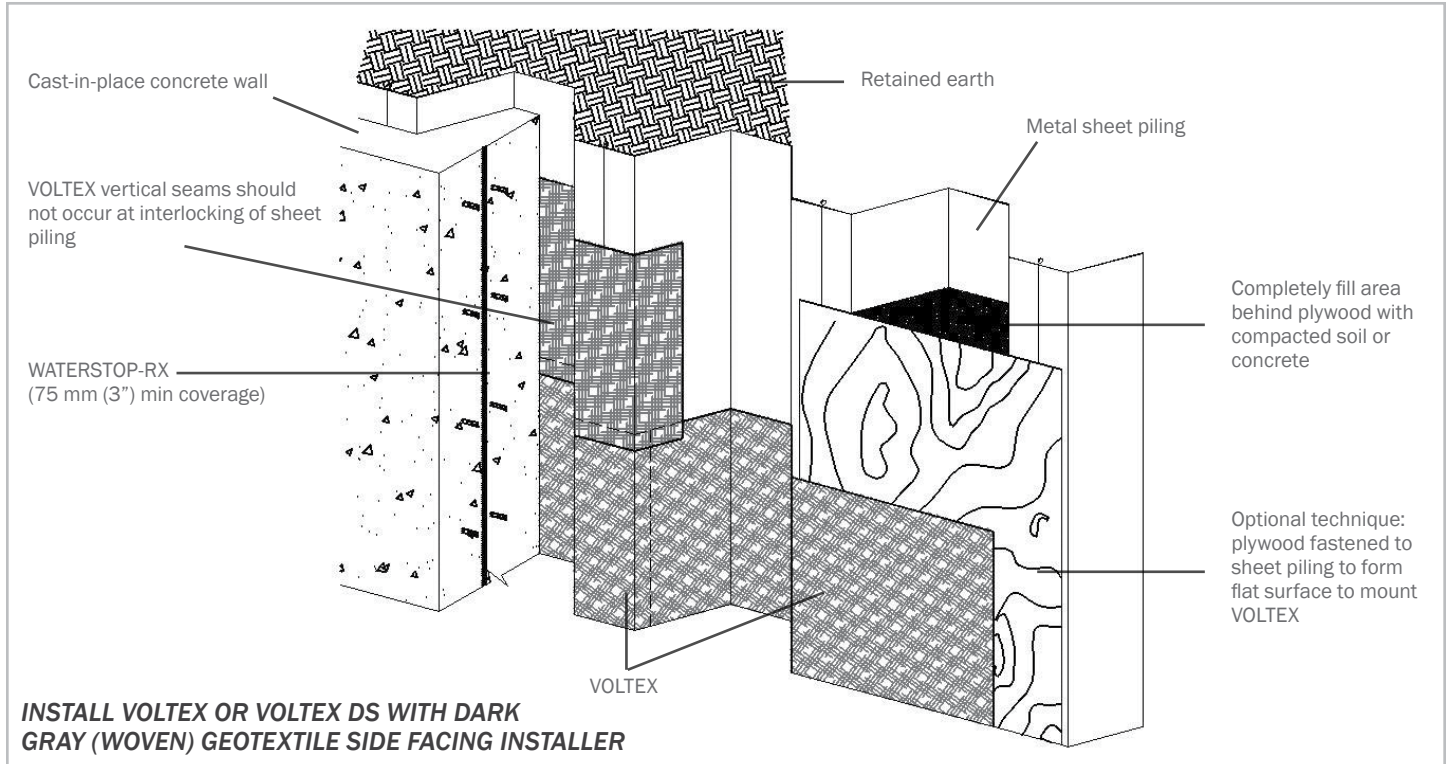

Figure 2.14 - Sheet pile interlock detail



INSTALL VOLTEX OR VOLTEX DS WITH DARK GRAY (WOVEN) GEOTEXTILE SIDE FACING INSTALLER

Figure 2.15 - Install VOLTEX onto metal sheet piling retaining wall with powder-actuated fasteners

2.4 EARTH FORMED SHOTCRETE RETAINING WALL

Verify the following substrate preparation work has been completed. Then install VOLTEX following the property line installation guidelines in Section 2.1 on page 12 and 13.

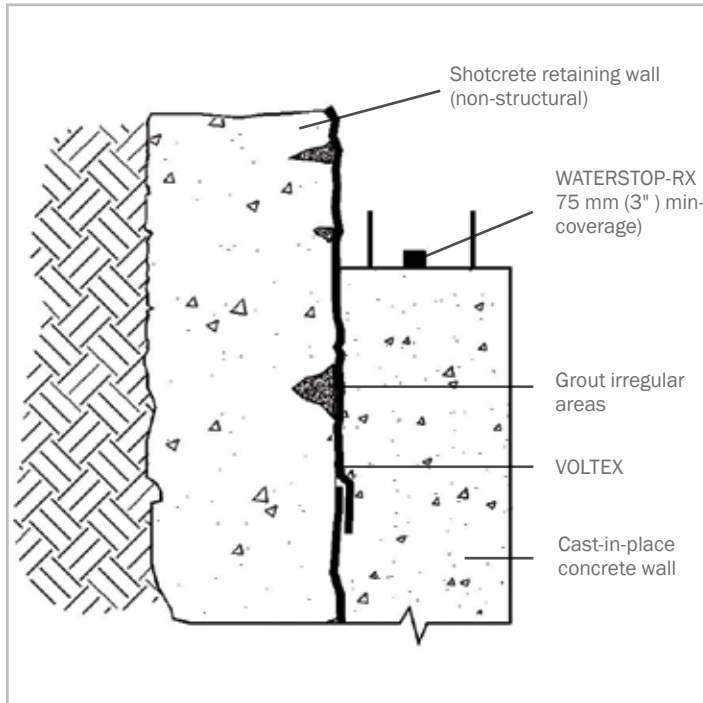

Figure 2.16 – Grout void area and remove protrusions to provide smooth surface for VOLTEX

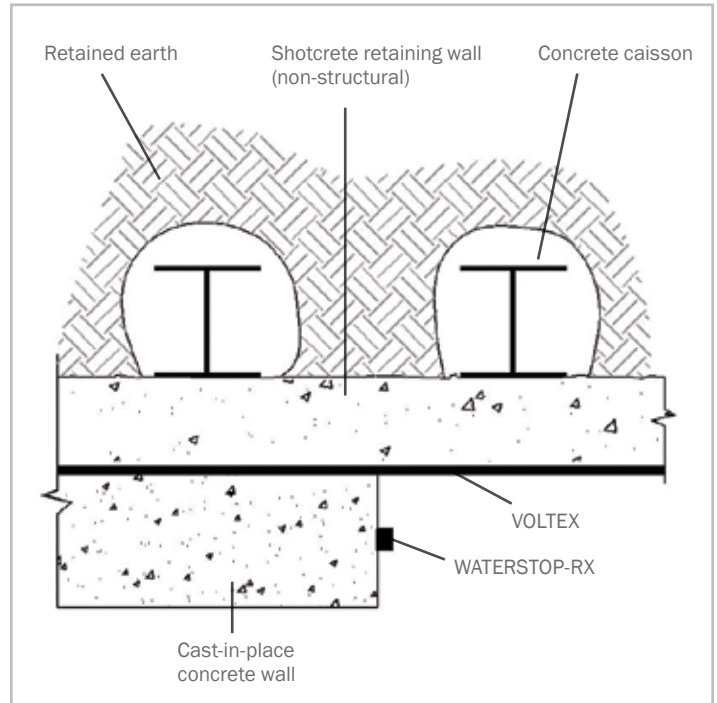

Figure 2.17 – Earth formed concrete retention wall with concrete caisson supports. (Plan View)

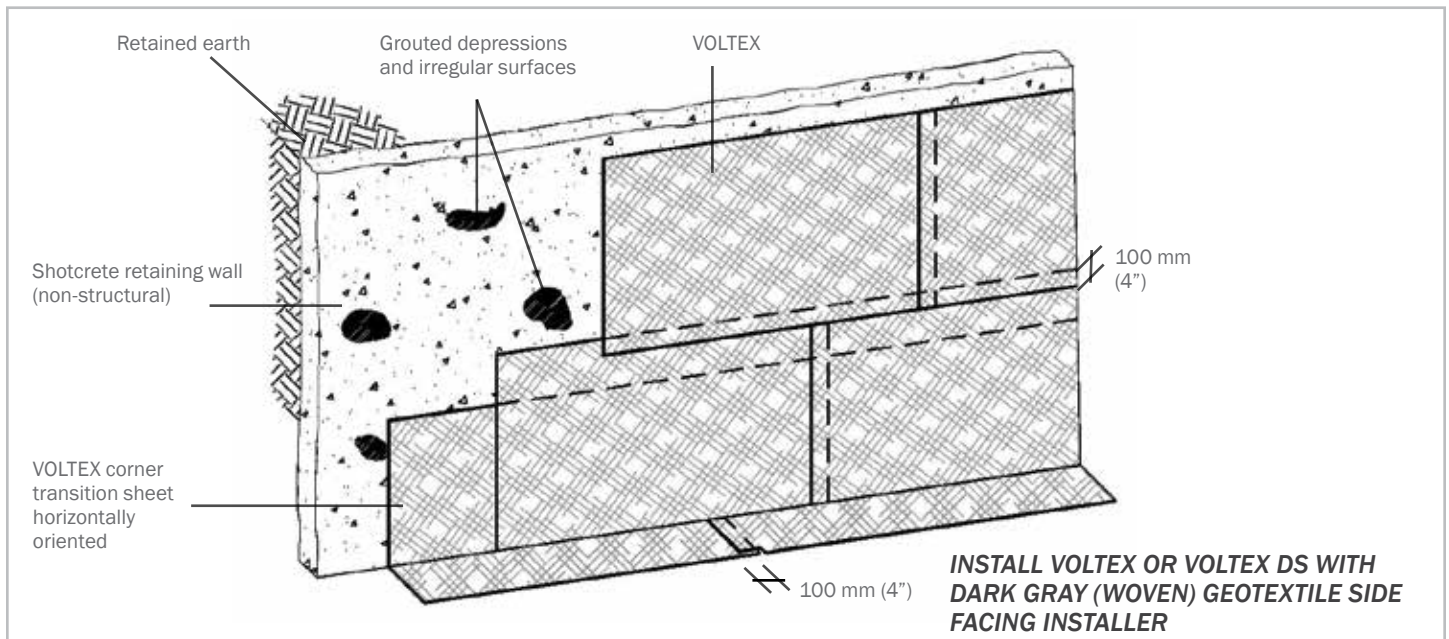

Figure 2.18 – VOLTEX installation over an earth formed shotcrete retaining wall prior to cast-in-place concrete wall

VOLTEX® & VOLTEX® DS
BENTONITE GEOTEXTILE WATERPROOFING FOR CAST-IN-PLACE CONCRETE APPLICATIONS

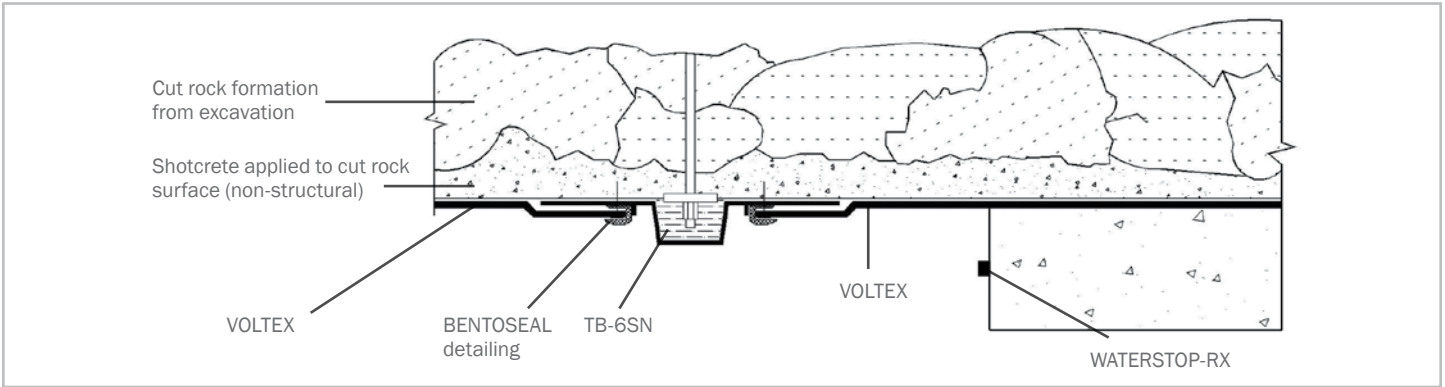

Figure 2.19 – Cut Rock excavation with shotcrete applied to provide a smooth surface for waterproofing installation

2.5 AUGER CAST CAISSON WALLS

Verify the following substrate preparation work has been completed. Then install VOLTEX following the property line installation guidelines in Section 2.1 on page 12 and 13.

Preparation: The surface of auger cast caisson and cut rock excavation walls must be sufficiently planar to provide an adequately smooth surface to apply VOLTEX. VOLTEX can be applied over large, relatively shallow indentations where VOLTEX can conform tight against the surface. The surface should not contain voids or sharp protrusions in excess of 25 mm (1”). Fill all large recesses between caissons with cementitious grout prior to installing VOLTEX (Figure 2.20). Cut rock excavations typically require shotcrete or grout work to provide acceptable surface to install VOLTEX (Figure 2.19).

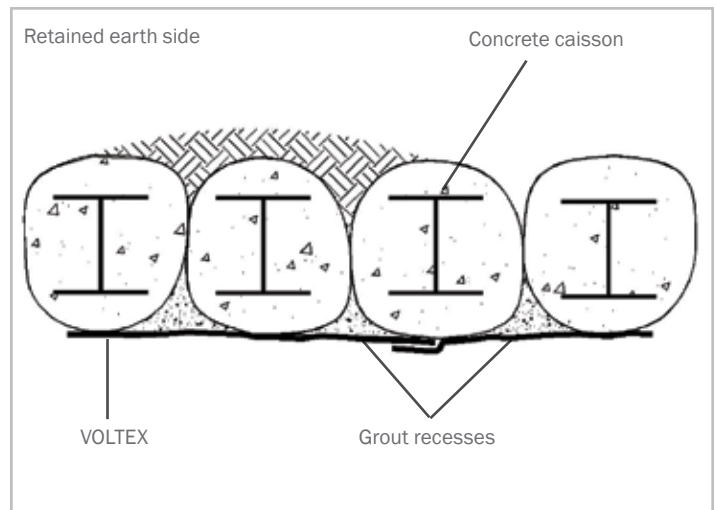

Figure 2.20 – Fill in recesses between cast caissons with grout to provide smooth surface (Plan View).

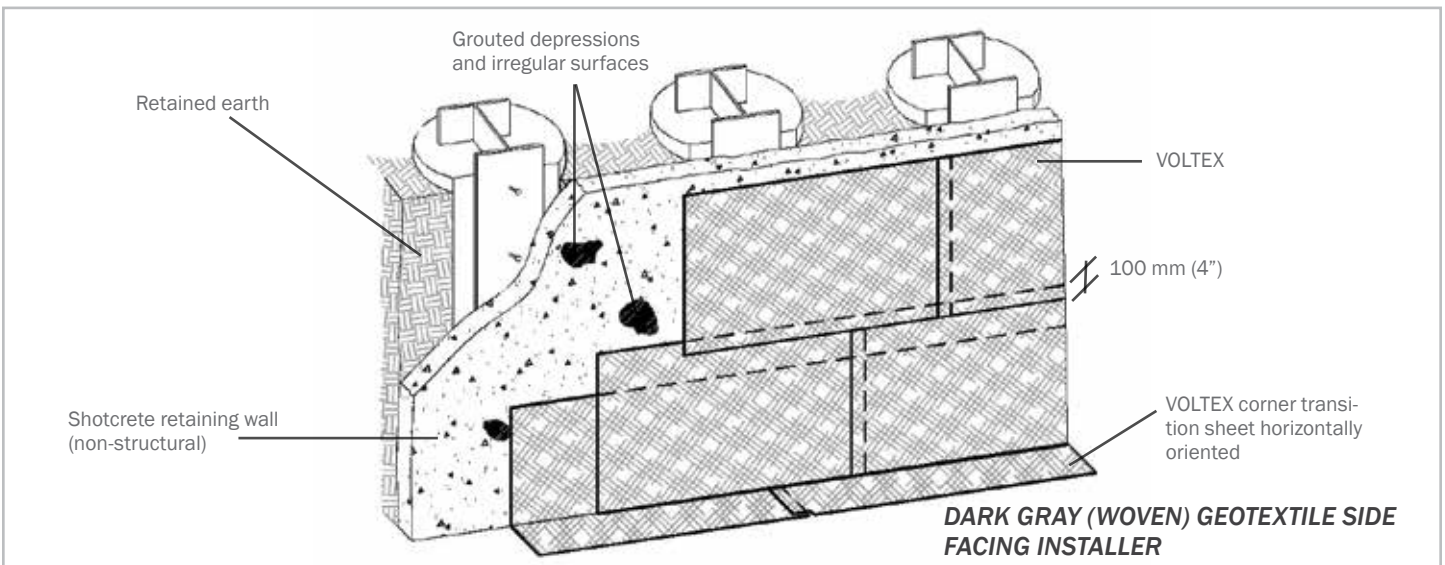

Figure 2.21 – VOLTEX installation over an auger cast concrete retention wall prior to cast-in-place concrete wall

SECTION 3 BACKFILLED WALLS

Install VOLTEX or VOLTEX DS with the dark gray (woven) geotextile side against the concrete wall on cast-in-place concrete foundation walls prior to backfilling. VOLTEX may be applied as soon as the forms are removed. It is not necessary to wait for the concrete to completely cure. Use VOLTEX with concrete cast with conventional forms that produce smooth surface.

3.1 SURFACE PREPARATION

Footings should be swept clean of silt, rocks and debris to provide VOLTEX with direct contact to the concrete in the application area. The wall surface must be properly prepared before VOLTEX is installed. Areas of surface honeycombing or voids should be filled with cementitious grout or BENTOSEAL. Protrusions of over 6 mm (1/4") should be knocked off smooth with the concrete surface. Concrete work should include completely filling taper-tie holes with non-shrink cementitious grout and a piece of WATERSTOP-RX centered in the wall (Figure 3.1). Apply BENTOSEAL over exterior grouted surface of all form tie holes (Figure 3.1).

3.2 INSTALLATION

Before installing the first course of VOLTEX, place Hydrobar Tubes at the wall/footing inside corner (Figure 3.2). "Butt" the ends of Hydrobar Tubes together to form a continuous line.

Beginning at the bottom corner of the wall, install VOLTEX horizontally oriented with 1.5 m (5') on one wall and the remainder around the corner on the other wall surface (Figure 3.2). Cut the bottom edge of VOLTEX at the corner a minimum of 150 mm (6") so that VOLTEX can be extended onto the footing. Fasten VOLTEX into position with washer head fasteners maximum 600 mm (24") on center. Then cut and install a VOLTEX section over the uncovered footing corner area. Apply BENTOSEAL at the VOLTEX section to VOLTEX overlaps. (Figure 3.2).

Install adjacent VOLTEX rolls of the bottom course horizontally oriented. Each roll should overlap the preceding roll a minimum 100 mm (4") and should extend onto the footing a minimum 150 mm (6"). At vertical inside corners apply a continuous 19 mm (3/4") fillet of BENTOSEAL directly in the corner prior to installing VOLTEX (Figure 3.3). Stagger all vertical overlap joints a minimum of 300 mm (12") (Figure 3.4). When hydrostatic conditions exist, the vertical wall VOLTEX should cover the entire footing and overlap the underslab waterproofing a minimum 150 mm (6") (Figure 3.6). Tape all VOLTEX DS membrane overlap seams with CETCO Seamtape.

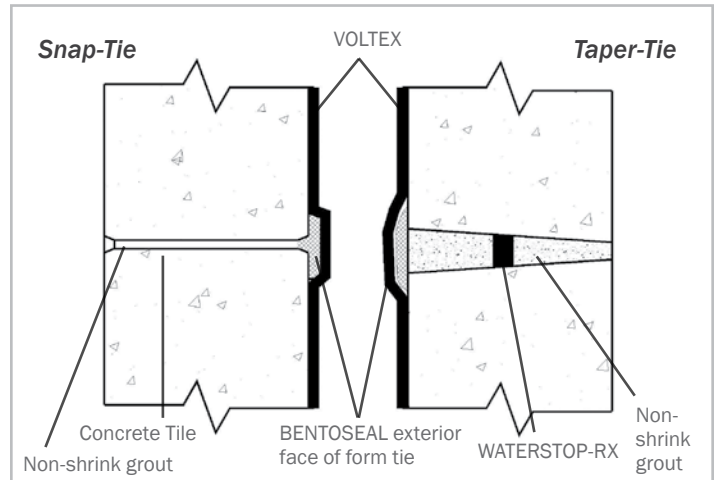

Figure 3.1 – Concrete form tie details

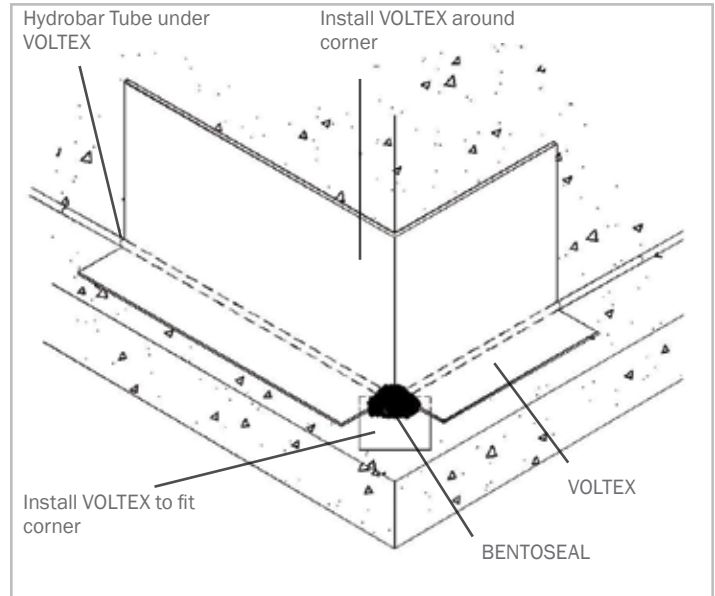

Figure 3.2 – Start VOLTEX at the corner horizontally. Place cut section at corner and apply BENTOSEAL at overlaps

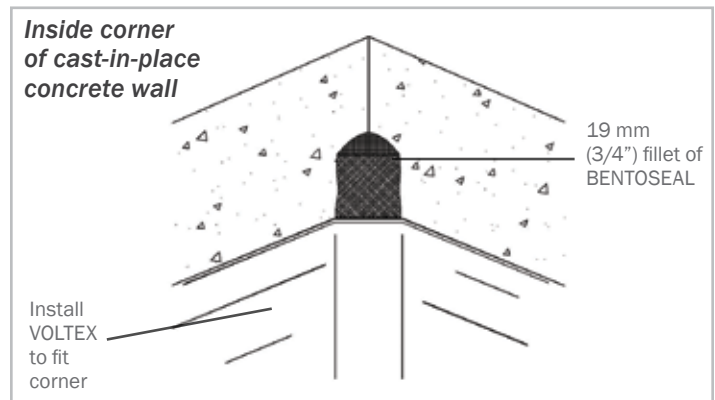

Figure 3.3 – Apply fillet of BENTOSEAL to inside corner

VOLTEX® & VOLTEX® DS
BENTONITE GEOTEXTILE WATERPROOFING FOR CAST-IN-PLACE CONCRETE APPLICATIONS

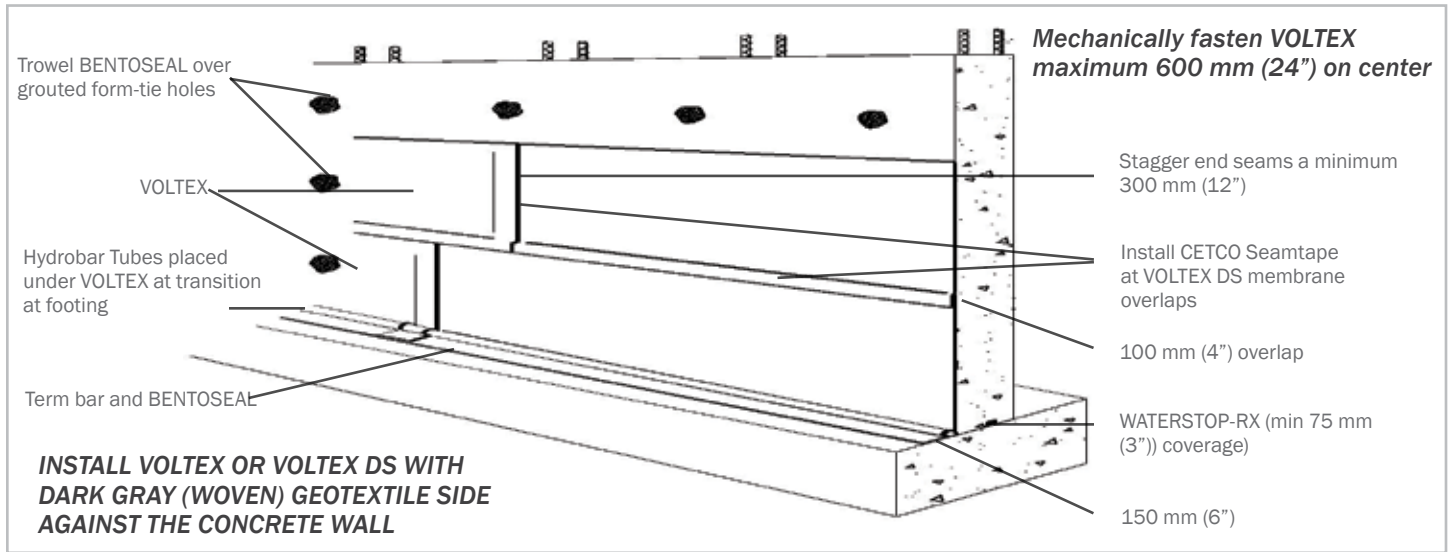

Figure 3.4 – VOLTEX installed on cast-in-place backfilled wall, overlap edges 100 mm (4”) and stagger vertical end laps

Backfill: The excavated area should be backfilled and compacted promptly after VOLTEX is installed. Use placed backfill as a platform in applying succeeding VOLTEX courses. The backfill must be compacted to a minimum 85% Modified Proctor density. Backfill should consist of compactible soils or angular aggregate (19 mm (3/4”) or less) free of debris, sharp objects, and stone larger than 19 mm (3/4”). When backfill cannot be placed immediately protect membrane from precipitation and debris by sealing edges to concrete substrate with CETCO SEAM-TAPE or tooled bead of CETSEAL. This temporary termination can be left in place covered by subsequent membrane overlap.

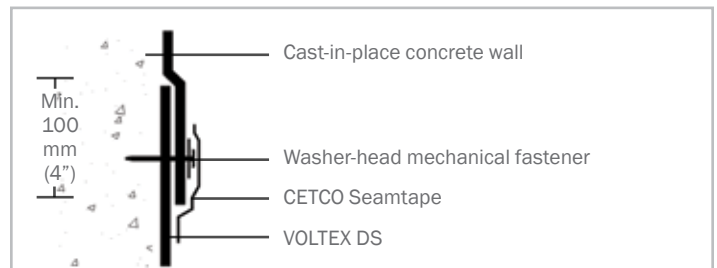

Figure 3.5 – Minimum VOLTEX overlap detail; tape VOLTEX DS seams

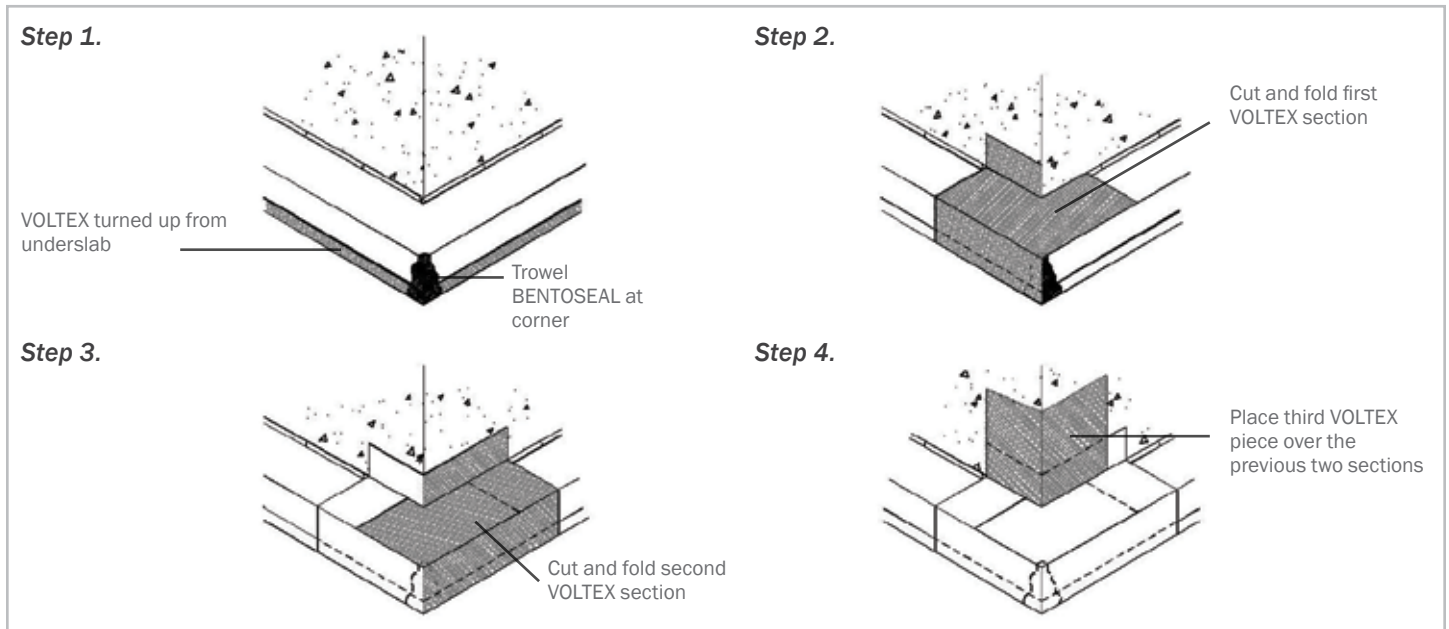

Figure 3.6 – Step by step detail of outside wall base corner installation (hydrostatic condition)

3.3 BACKFILLED WALL PENETRATIONS

Cut VOLTEX to closely fit around penetrations. After installing VOLTEX, trowel a minimum 19 mm (3/4") thick fillet of BENTOSEAL around the penetration to completely fill any space between the penetration and the VOLTEX edge. The BENTOSEAL should extend onto the penetration 38 mm (1-1/2") and cover VOLTEX's edge (Figure 3.7). In areas where multiple penetrations are close together, it may be impractical to cut VOLTEX to fit around base of each penetration. Therefore, apply a 19 mm (3/4") thick fillet of BENTOSEAL around each penetration and cover the entire surface between the penetrations (Figure 3.8). Extend BENTOSEAL 38 mm (1-1/2") onto the penetrations.

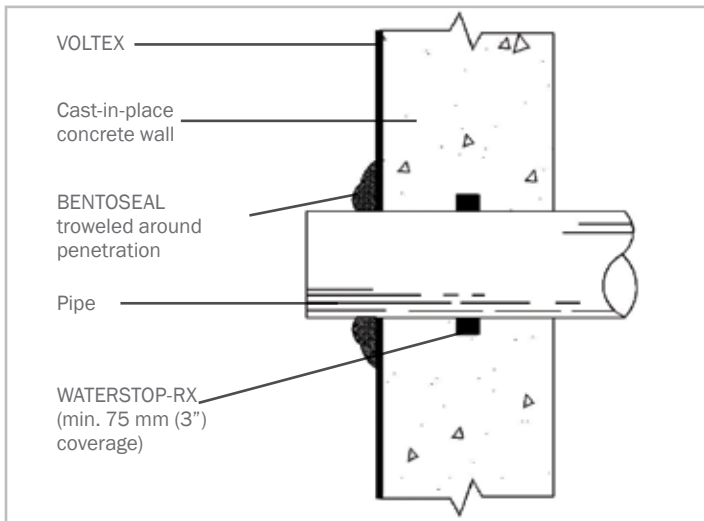

Figure 3.7 – Single penetration cast-in-place wall detail

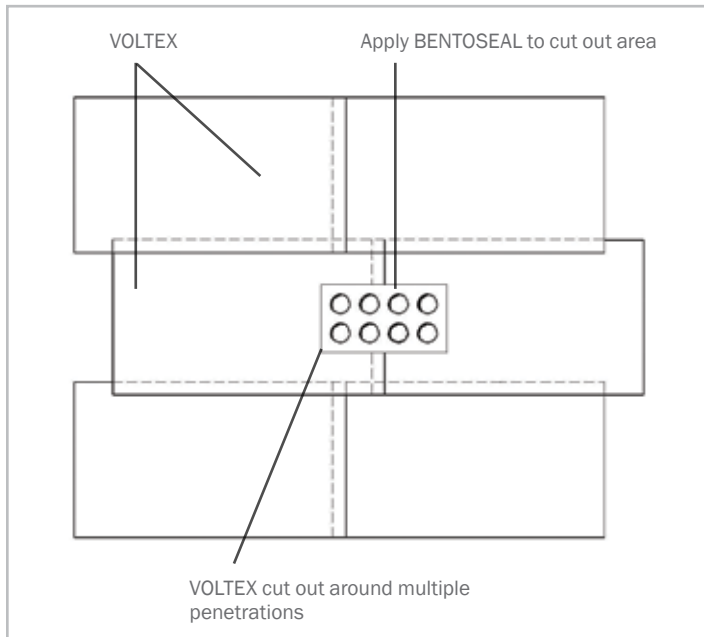

Figure 3.8 – Cut VOLTEX to fit around penetrations

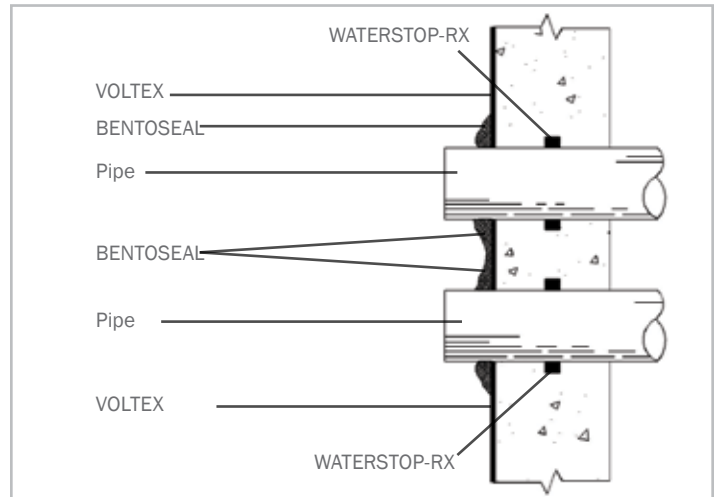

Figure 3.9 – Close multiple penetrations. Trowel BENTOSEAL around and between penetrations

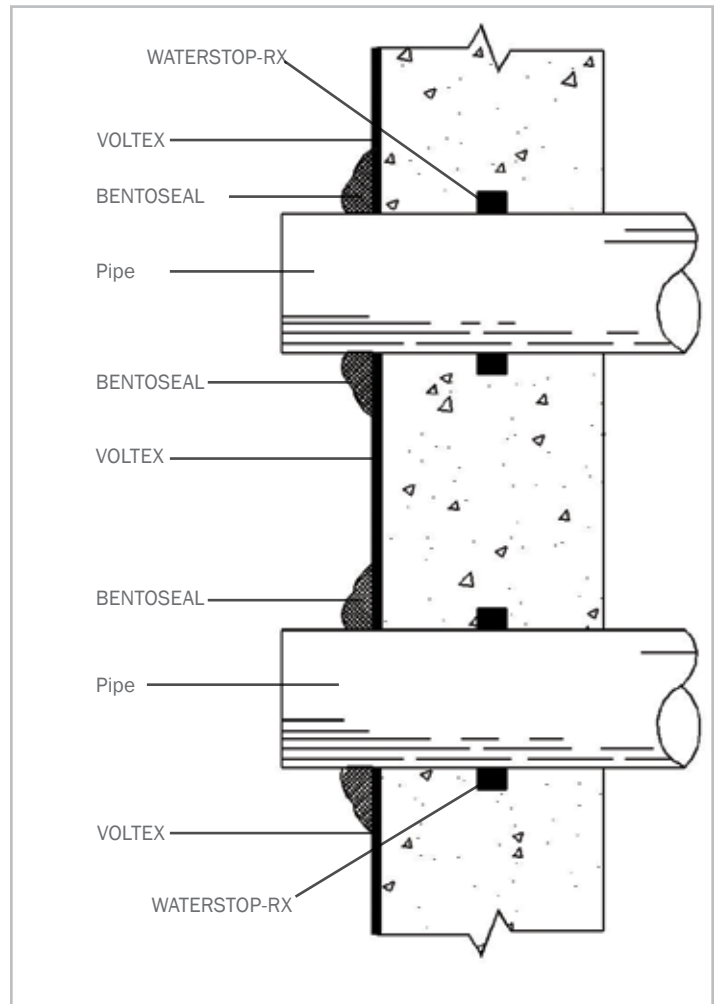

Figure 3.10 – Install VOLTEX between penetrations with accessibility. Trowel BENTOSEAL around penetrations

VOLTEX® & VOLTEX® DS

BENTONITE GEOTEXTILE WATERPROOFING FOR CAST-IN-PLACE CONCRETE APPLICATIONS

3.4 GRADE TERMINATIONS

Terminate VOLTEX membrane 300 mm (12") below finished grade elevation with washer-head fasteners maximum 300 mm (12") on center. Install ENVIROSHEET flashing to primed concrete substrate with bottom edge overlapping top edge of VOLTEX membrane minimum 100 mm (4"). Overlap all roll ends a minimum 100 mm (4") to form a continuous flashing. Height of flashing shall be per project details and specifications. Install a rigid termination bar along top edge of ENVIROSHEET; fastened maximum 300 mm (12") on center. Complete grade termination detail with tooled bead of CETSEAL along the top edge, at all penetrations through the flashing, and all exposed overlap seams. Grade terminations are illustrated in Figures 3.11 and 3.12.

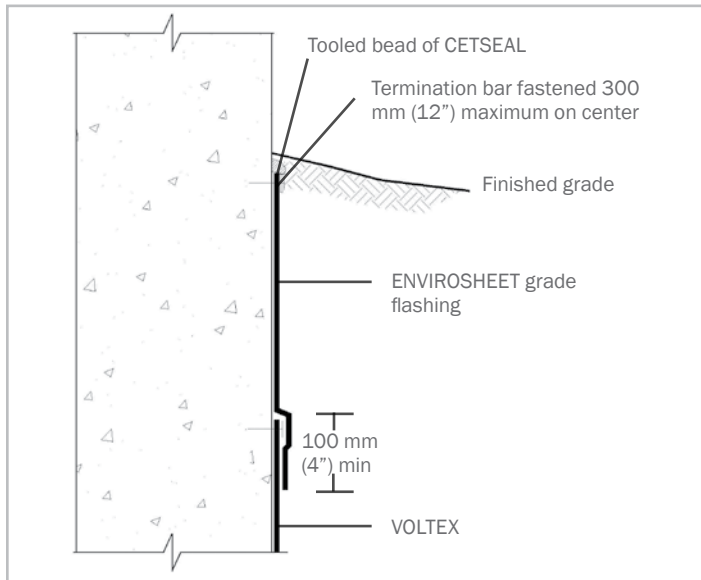

Figure 3.11 – Termination at finished grade

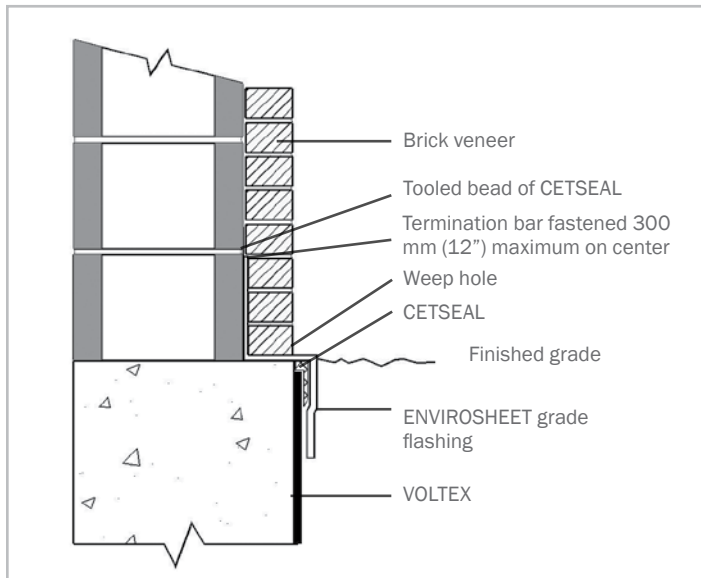

Figure 3.12 – Termination at grade with brick veneer

3.5 MASONRY BLOCK WALLS

VOLTEX is not recommended for waterproofing masonry block walls. Consult with CETCO regarding recommended products and installation guidelines for masonry block walls.

SECTION 4 SPECIAL CONDITIONS

4.1 PRECAST CONCRETE CONSTRUCTION

Consult CETCO regarding products and special installation guidelines for precast concrete plank decks, precast earth covered roofs, and precast wall construction.

4.2 CONTAMINATED CONDITIONS

Use VOLTEX CR (Contaminant Resistant) in conditions where the groundwater contains high concentrations of chemicals or saline. These conditions are typically encountered at industrial sites and coastal regions. If groundwater contains strong acids, alkalies, or has a conductivity of 2,500 µmhos/cm or greater (high salt concentration), water samples should be submitted to CETCO for compatibility testing.

For compatibility testing, provide two (2) liters of site groundwater in a clean, unbreakable container. Ship water sample to: CETCO, 2870 Forbs Ave, Hoffman Estates, IL 60192, ATTN: BMG Field Services. Upon analysis, CETCO will provide a written report evaluating the water's compatibility with VOLTEX and recommend any special product and/or installation requirements.

IMPORTANT NOTICE

FOR SHOTCRETE, PRECAST CONCRETE, EXPANSION JOINTS AND OTHER APPLICATIONS NOT COVERED IN THIS MANUAL, CONTACT CETCO FOR TECHNICAL ASSISTANCE AND INSTALLATION GUIDELINES.

PRODUCT TABLE

PRODUCT	DESCRIPTION
VOLTEX	Bentonite geotextile waterproofing membrane with standard sodium bentonite
VOLTEX CR	Bentonite geotextile waterproofing membrane with contaminant resistant sodium bentonite
VOLTEX DS	Bentonite geotextile waterproofing membrane with standard sodium bentonite and a polyethylene liner component
VOLTEX DSCR	Bentonite geotextile waterproofing membrane with contaminant resistant sodium bentonite and a polyethylene liner component

IMPORTANT NOTICE

Contact CETCO for verification of specification and installation requirements to comply for eligibility of HydroShield Warranty.

LIMITED WARRANTY

The information and data contained herein is believed to be accurate and reliable. Specifications and other information contained herein supersede all previously printed material and are subject to change without notice.

Manufacturer's warranty of installed system is available. Contact seller for terms and sample documents including all limitations.

All goods sold by seller are warranted to be free from defects in material and workmanship.

The foregoing warranty is in lieu of and excludes all other warranties not expressly set forth herein, whether expressed or implied by operation of law or otherwise including but not limited to any implied warranties of merchantability or fitness.

Seller shall not be liable for incidental or consequential losses, damages or expenses, directly or indirectly arising from the sale, handling or use of the goods, or from any other cause relating thereto, and seller's liability hereunder in any case is expressly limited to the replacement (in the form originally

shipped) of goods not complying with this agreement or at seller's election, to the repayment of, or crediting buyer with, an amount equal to the purchase price of such goods, whether such claims are for breach of warranty or negligence.

Any claim by buyer with reference to the goods sold hereunder for any cause shall be deemed waived by buyer unless submitted to seller in writing within thirty (30) days from the date buyer discovered or should of discovered, any claimed breach.

Materials should be inspected and tested by purchaser prior to their use if product quality is subject to verification after shipment. Performance guarantees are normally supplied by the applicator.

Note: VOLTEX waterproofing system is not an expansion joint material.



www.cetco.com | contact@cetco.com

UPDATED: SEPTEMBER 2015

© 2015 CETCO. IMPORTANT: The information contained herein supersedes all previous printed versions, and is believed to be accurate and reliable. For the most up-to-date information, please visit www.CETCO.com. CETCO accepts no responsibility for the results obtained through application of this product. CETCO reserves the right to update information without notice.

FORM: PM_VOLTEX_AM_EN_201509_V7

