

Bridging Termination Clip (BTC6-54) 54mil (16ga) U-Channel Lateral Bracing Clip

The ClarkDietrich Bridging Termination clip is used to secure U-Channel or Cold Rolled Channel (CRC) to structural wall studs when used in load-bearing or curtain wall applications. (loads for structural stud gauges of 20, 18, 16, 14 & 12). The BTC's unique design allows for quicker installation in end-of-wall conditions.

The BTC is a stiffened, G90 galvanized steel clip that's tested and designed to facilitate rapid, efficient installation of 1-1/2" U-Channel lateral bracing for exterior curtain wall framing, load-bearing walls or high interior partitions constructed of structural studs.

BTC clips are fastened using #8 self-drilling screws; 2 screws between clip and U-channel and 2 screws between clip and stud flanges. Design loads & tables can be found on the 2nd page of this submittal or at www.clarkdietrich.com/BTC.

The BTC clips are designed to be used with 3-5/8", 4" or 6" structural studs only.

Product Data & Ordering Information:

Material: 50ksi yield strength
 Coating: G90
 Thickness: 54mil (16ga), 0.0566" Design Thickness, 0.0538" Min. Thickness
 Dimensions: Made to fit over 1-1/2" U-Channel and around the flange of a 6" stud.
 Packaging: 50 pieces per bucket
 Product weight: 0.44 lb / piece

ASTM & Code Standards:

- Galvanized sheet steel meets or exceeds requirements of ASTM A653
- SDS & Product Certification Information is available at www.clarkdietrich.com/SupportDocs

Installation:

Install the BTC by sliding the flanges of the clip over the open side of the stud and positioning the clip over the CRC using the guides on the underside of the clip. Once in place, fasten to the CRC using #8 screws. Finally, fasten the flanges of the clip to the stud flange by using #8 screws.

Alternative Products:

- FastBridge Clip (FB33, FB43 & FB68)
- SwiftClip™ (LS-Series), Spazzer® 5400 Bridging Bar

05.40.00 (Cold-Formed Metal Framing)

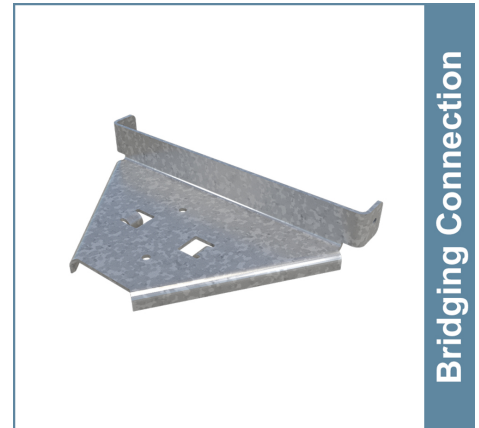

U.S. Patent No. 10,851,539 B2



Sustainability Credits:

For more details and LEED letters contact Technical Services at 888-437-3244 or visit www.clarkdietrich.com/LEED

LEED v4 MR Credit -- Building Product Disclosure and Optimization: EPD (1 point) - Sourcing of Raw Materials (1 point) - Material Ingredients (1 point) - Construction and Demolition Waste Management (up to 2 points) - Innovation Credit (up to 2 points).

LEED 2009 Credit MR 2 & MR 4 -- ClarkDietrich's steel products are 100% recyclable and have a national average recycled content of 34.2% (19.8% post-consumer and 14.4% pre-consumer). If seeking a higher number to meet Credit MR 5, please contact us at (info@clarkdietrich.com / 888-437-3244)

Project Information

Name:
Address:

Contractor Information

Name:
Contact:
Phone:
Fax:

Architect Information

Name:
Contact:
Phone:
Fax:

BRIDGING TERMINATION CLIP (LOAD TABLES)

BRIDGING TERMINATION CLIP (BTC3,BTC4,BTC6)

U-Channel Lateral Bracing Clip

The ClarkDietrich Bridging Termination clip is tested and designed to secure U-Channel or Cold Rolled Channel (CRC) to structural wall studs when used in load-bearing or curtain wall applications. (loads for structural stud gauges of 20, 18, 16, 14 & 12). The BTC's unique design allows for quicker installation in end-of-wall conditions.

The BTC clip should not be used in studs over 6" wide.

INSTALLATION

Install the BTC by sliding the flanges of the clip over the open side of the stud and positioning the clip over the CRC using the guides on the underside of the clip. Once in place, fasten to the CRC using #8 screws. Finally, fasten the flanges of the clip to the stud flange by using #8 screws.

MATERIAL SPECIFICATIONS

Gauge: 18 gauge, 16 gauge, 14 gauge

Material Strength: Structural Grade 50, 50ksi minimum yield strength

Finish: Galvanized (G90)

ASTM: A653/A653M, A1003/A1003M

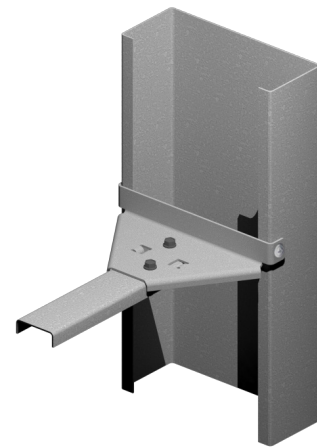
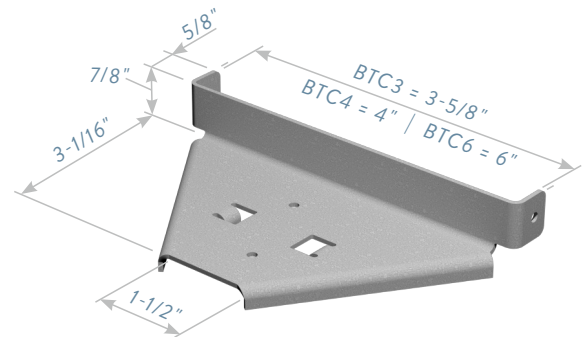

TERMINATION CLIP

Product code	Stud Depth	Clip Gauge Mils	Allowable Capacities	Stud Thickness, gauge (mils)				
				20 (33)	18 (43)	16 (54)	14 (68)	12 (97)
BTC3	3-5/8"	18 (43mils)	Axial Brace Stiffness (lbs/in)	2120	2120	2120	2190	2190
BTC4	4"		Axial Brace Strength (lbs)	215	235	240	280	280
BTC6	6"		Torsional Moment (in-lbs)	310	310	320	325	325
BTC3	3-5/8"	16 (54mils)	Axial Brace Stiffness (lbs/in)	2965	3135	3175	3345	3345
BTC4	4"		Axial Brace Strength (lbs)	320	350	375	410	410
BTC6	6"		Torsional Moment (in-lbs)	510	515	520	525	525
BTC3	3-5/8"	14 (68mils)	Axial Brace Stiffness (lbs/in)	3915	4325	4525	4825	4825
BTC4	4"		Axial Brace Strength (lbs)	460	500	555	570	570
BTC6	6"		Torsional Moment (in-lbs)	760	775	775	790	790

Notes:

- 1 Allowable loads are based on the use of cold-formed steel studs with a minimum yield strength, $F_y=33$ ksi and tensile strength, $F_u=45$ ksi for 43mil (18ga) or thinner and a minimum yield strength, $F_y=50$ ksi and tensile strength, $F_u=65$ ksi for 54 mil (16ga) or thicker.
- 2 Allowable loads are based on 54mil (16ga) U-Channel bridging with a minimum yield strength, $F_y=33$ ksi and tensile strength, $F_u=45$ ksi.
- 3 Allowable loads are for the termination bridging connection only. The strength and serviceability of the framing members is the responsibility of the designer.
- 4 Allowable loads are based on minimum #8 self drilling with a minimum nominal diameter of 0.163-in and a minimum head diameter of 0.437-in. Fasteners must have a minimum nominal shear strength of, $P_{ss}=1452$ -lbs and a nominal tensile strength of, $P_{ts} = 2089$ lbs. (See ICC-ESR 1271 for fastener information.)
- 5 Allowable loads are based on the use of 2 screws between clip and U-Channel and 2 screws between clip and stud flanges.
- 6 Allowable loads may not be increased for wind or seismic load.
- 7 Allowable loads are for use when using ASD design methodology. For LRFD loads, multiply ASD allowable loads by 1.6.
- 8 Allowable brace loads were derived from nominal loads obtained from tests, divided by a safety factor. Serviceability limits are not considered. Brace stiffness requirements are detailed in AISI S100 Section D3.3.
- 9 Axial brace stiffness values apply to both ASD and LRFD designs.