

Product category: PRO300 (3" flange RedHeader PRO) As Header
Product name: 400PRO300-54 (50ksi, CP60) - Unpunched
 54mils (16ga) Coating: CP60 per ASTM C955

Geometric Properties

Web depth	4.000 in	Design thickness	0.0566 in
Flange width	3.000 in	Min. steel thickness	0.0538 in
Stiffening lip	1.000 in	Yield strength, Fy	50 ksi

Gross Section Properties of Full Section, Strong Axis

Cross sectional area (A)	0.655 in ²
Member weight per foot of length	2.23 lb/ft
Moment of inertia (Ix)	1.793 in ⁴
Section modulus (Sx)	0.896 in ³
Radius of gyration (Rx)	1.654 in
Gross moment of inertia (Iy)	0.895 in ⁴
Gross section modulus (Sy)	0.510 in ³
Gross radius of gyration (Ry)	1.169 in

Effective Section Properties, Strong Axis

Moment of inertia for deflection (Ixe)	1.727 in ⁴
Moment of inertia for deflection (Iye*)	0.821 in ⁴
Section modulus (Sxe)	0.746 in ³
Section modulus (Sye*)	0.458 in ³
Allowable bending moment (Max - Local)	22.33 in-k
Allowable bending moment (May - Local*)	13.70 in-k
Allowable bending moment (Max - Distortional)	22.52 in-k
Allowable bending moment (May - Distortional*)	12.82 in-k
Allowable shear force in web (Vax)	3372 lb

Torsional Properties

St. Venant torsion constant (J x 1000)	0.700 in ⁴
Warping constant (Cw)	4.461 in ⁶
Distance from shear center to neutral axis (Xo)	-2.886 in
Radii of gyration (Ro)	3.526 in
Torsional flexural constant (Beta)	0.330

Section Property Notes

* Iye, Sye, and May are for a positive moment with the return lips in compression.
 (Installing the header with the flanges pointing up)

ASTM & Code Standards:

- AISI S100-12 and S100-07 w/S2-10 supplements
- Effective properties incorporate the strength increase from cold work of forming
- Structural framing is produced to meet or exceed ASTM C955
- Sheet steel meets or exceeds mechanical and chemical requirements of ASTM A1003
- SDS & Product Certification Information is available at www.clarkdietrich.com

Sustainability Credits:

For more details and LEED letters contact Technical Services at 888-437-3244 or visit www.clarkdietrich.com/LEED

LEED v4 MR Credit -- Building Product Disclosure and Optimization: EPD (1 point) - Sourcing of Raw Materials (1 point) - Material Ingredients (1 point) - Construction and Demolition Waste Management (up to 2 points) - Innovation Credit (up to 2 points).

LEED 2009 Credit MR 2 & MR 4 -- ClarkDietrich's steel products are 100% recyclable and have a national average recycled content of 34.2% (19.8% post-consumer and 14.4% pre-consumer). If seeking a higher number to meet Credit MR 5, please contact us at (info@clarkdietrich.com / 888-437-3244)

05.40.00 (Cold-Formed Metal Framing)

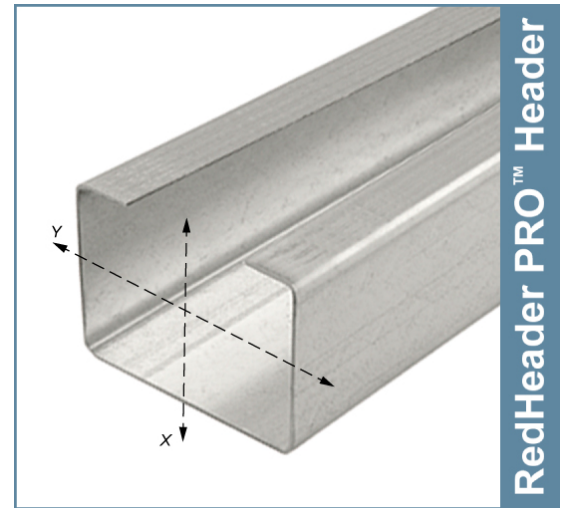

- Replaces lay-in and boxed headers.
- Reduces material pieces, weight & screws.
- Insulation installs quicker.

Ordering Information:

Header lengths should be ordered ½" shorter to fit inside HDSC Header Brackets.
 (Header length = inside of jamb to inside of jamb - ½")

HDSC Header Bracket profile data:

See HDSC Header Bracket submittal sheet for allowable clip loads. All headers require the attachment of the HDSC Clip at each end with headers installed leg up.

Project Information

Name:
 Address:

Contractor Information

Name:
 Contact:
 Phone:
 Fax:

Architect Information

Name:
 Contact:
 Phone:
 Fax: