

Drywall Z-Furring Channel

3" depth x 30mils (20 ga DW)

Z-Furring channels are an ideal product for furring out the interior walls on an existing masonry or new concrete / masonry walls. It is especially useful when insulation is required on the interior side of a masonry wall. The short leg is attached to masonry and sheathing is attached to the long leg.

Product Data & Ordering Information:

Material: All Material: Grade 33ksi min. yield strength
30mils (20 ga DW), 0.0312" Design Thickness, 0.0296" Min. Thickness
Coating: G40EQ (G40 or G60 available)
Dimensions: Leg 1 = 3/4", Leg 2 = 1-1/4", Depth = 3"
Stock Lengths: 10'-0" long
Packaging: (10) pieces per bundle - (280) pieces per pallet
Packaging weight: 51 lbs/bundle or 510 lbs/1000ft

ASTM & Code Standards:

- ASTM C645 - Standard Specification for Nonstructural Steel Framing Members
- ASTM C955 - Standard Specification for Cold-Formed Steel Structural Framing Members
- ASTM A1003 - Standard Specification for Steel Sheet, Carbon, Metallic- and Nonmetallic-Coated for Cold-Formed Framing Members
- For installation & storage information refer to ASTM C754 or C1007
- SDS & Product Certification Information available at www.clarkdietrich.com/SupportDocs

Related Accessories:

- Other profile depths available: 1", 1-1/2", 2", 2-1/2" and 3"
- 7/8" and 1-1/2" Furring / Hat Channel
- Single and Double Leg Resilient Channel

09.22.16 (Non-Structural Metal Framing)

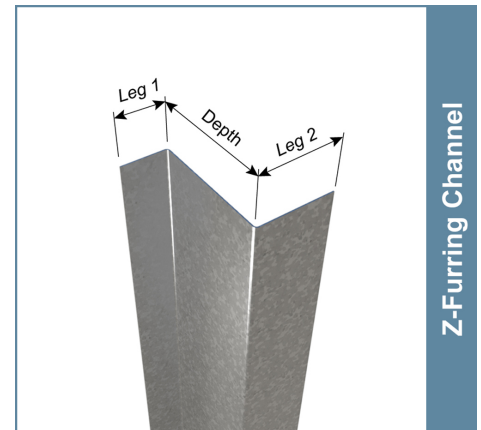

- Furring for masonry walls
- Allows for rigid insulation

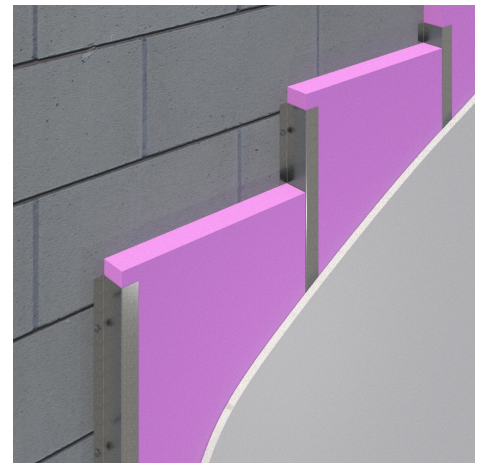

Sustainability Credits:

For more details and LEED letters contact Technical Services at 888-437-3244 or visit www.clarkdietrich.com/LEED

LEED v4 MR Credit -- Building Product Disclosure and Optimization: EPD (1 point) - Sourcing of Raw Materials (1 point) - Material Ingredients (1 point) - Construction and Demolition Waste Management (up to 2 points) - Innovation Credit (up to 2 points).

LEED 2009 Credit MR 2 & MR 4 -- ClarkDietrich's steel products are 100% recyclable and have a national average recycled content of 34.2% (19.8% post-consumer and 14.4% pre-consumer). If seeking a higher number to meet Credit MR 5, please contact us at (info@clarkdietrich.com / 888-437-3244)

Project Information

Name:
Address:

Contractor Information

Name:
Contact:
Phone:
Fax:

Architect Information

Name:
Contact:
Phone:
Fax: