

INSTALLATION GUIDE

FOR CORRUGATED ROOFING PANEL INSTALLATION

SEQUENTIA SUPER600 | SEQUENTIA WEATHERGLAZE

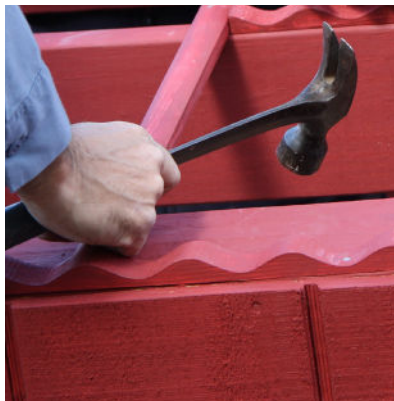

frp

FIBERGLASS REINFORCED PANELS

INSTALLATION GUIDE FOR CORRUGATED ROOFING PANEL INSTALLATION

DISCLAIMER

PLEASE READ ALL INSTRUCTIONS BEFORE BEGINNING INSTALLATION

These guidelines are provided in good faith to help prevent installation problems caused by common errors. The manufacturer and/or distributor of the product bears no responsibility for installation actions taken or not taken. There are many nuances of installation that are assumed to be general construction knowledge to an experienced installer; such nuances are not included in these instructions. Rather, these installation guidelines are strictly recommendations and are not intended to serve as a step-by-step, foolproof installation checklist. Selection of an experienced FRP installer is the sole responsibility of the project owner and architect. VALTO does not accept any responsibility for job failure resulting from or associated with improper job site environmental conditions.

SEE OUR MOST CURRENT SDS AT VALTOEM.COM/SDS.HTML PRIOR TO WORKING WITH OUR PRODUCTS

GENERAL INFORMATION

Safety Information

WHEN CUTTING OR DRILLING, ALWAYS WEAR PROTECTIVE GLASSES OR GOGGLES AND A FACE MASK WHICH COVERS THE FACE AND MOUTH. Itching due to glass fibers may be avoided by the use of barrier creams on exposed skin areas. Hearing protection is also recommended.

DO NOT WALK ON PANELS. Observe simple fire precautions. Similar to wood or equal thickness, fiberglass panels can be flash-ignited at approximately 700°F.

Important

Before beginning this project, be sure to check your local building codes pertaining to locating and constructing structures; obtain any permits and inspections that may be required. As required by law, before you dig on construction sites, have all buried utilities (electric, gas, water, phone, cable, etc.) located and clearly marked by a qualified professional

Supplies and Equipment

STANDARD TOOLS NEEDED

- Hammer
- Carpenter square
- 4' level
- Power circular saw
- Power drive and bits: 1/8" and 3/8"
- Caulking Gun
- Caulk

VALTO MATERIALS NEEDED

- Sequentia FRP Corrugated Panels
- Sequentia vertical filler strips (R79040)
- Sequentia horizontal filler strips (R79039)
- Sequentia end wall or ridgeroll flashing
- Sequentia galvanized aluminum 1-3/4" gauge nails (R79003)

Storage

While a single panel easily withstands exposure to sunlight and the elements, a stack of fiberglass panels will trap heat and moisture, causing clouding in the panels. To avoid this irreversible effect, panels should be stored in a dry, shaded, well-ventilated area. Store panels on edge or on end. Skids should be elevated at one end with wood spacers.

Cleaning Instructions

Panels may be washed with either mild detergent-type cleaners or by steam and high-pressure spray systems. Apply cleaners with sponge or soft brush and rinse thoroughly in cold water to eliminate cleaning agent film build-up. Always follow cleaning agent manufacturer's instructions. Test small area before applying over entire surface. Hard water deposits may be removed with a 10% solution of acetic acid in COLD water. Rinse thoroughly. Panels may be waxed to maintain luster and beauty. Always follow wax manufacturer's application instructions.

Minimum Bend Radius

(2.67" x 7/8") Flexing the panel to the point of buckling can cause fracture and rapid deterioration at the fracture point. Install at ambient temperatures not below 60°F.

Maximum Recommended Spans

The following data is based upon uniform loading of corrugated FRP panels with a safety factory of 2.5, and fastened as recommended.

Corrugated Panels	10 psf	20 psf	30 psf	40 psf
WeatherGlaze Panel	38"	31"	27"	24"
Super 600 Panel	38"	32"	30"	24"

NOTE: Table is based on a section properties or actual load test. Design loads are governed by local building codes. Conduct code authorities for specific load and stresses. Information is provided as preliminary data for designers. It should be checked and verified for use with a duly licensed engineer or architect.

Framing

Provide purlin members at recommended maximum intervals required for corrugation section. See chart above for first column.

CUTTING

Cut fiberglass panels using hand or power saws. Saw blades should be fine-toothed carbide tipped, or safety fabric reinforced abrasive disc. Face shields and appropriate safety equipment should be worn.

DRILLING

All panels should be pre-drilled not less than 1-1/2" from panel end holes drilled a minimum of 1/16" larger than the fastener diameter. Panels may be drilled singly or several at a time.

BASIC FRP INSTALLATION INSTRUCTIONS

These instructions are intended as guidelines for proper installation procedures. In the use of tools, fasteners, sealants, and adhesives, follow manufacturer's recommended procedures.

Installation

For best protection against prevailing winds and weather, install panels beginning at leeward end of run and work to windward.

1. Provide a minimum of one corrugation overlap at sides.
2. Provide 8" end-laps for roofs with pitch of less than 4/12. Use 6" end-laps for pitches greater than 4/12.
3. Fasten panels through crowns at every second corrugation. Fasteners with armored Neoprene washers are recommended. Space fasteners 6" to 8" on-center along panel edges and 12" to 16" on-center for intermediate rafters and blocking.

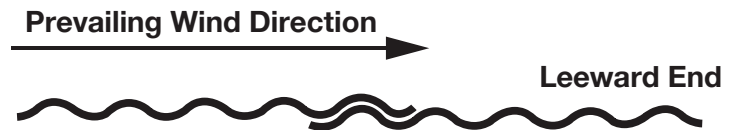

Construction Notes

1. To avoid deflection of panels, tighten screws until washers will not rotate, then tighten one more turn.
2. Avoid excess burrs on drilled or punched holes to protect Neoprene sealing face.
3. To help insure weather tight roof, apply a small amount of clear sealer at each hole before installing nails or screws.

Recommended Overlap

(2.67" x 9/16") Overlaps shown will provide best protection against leakage and air infiltration. Vinyl lap seal and/or mastic must also be used to achieve effective seal on side-laps and end-laps.

Typical Fasteners

Include aluminum or galvanized nails or wood screws with Neoprene washers. Fastener selection is dependent upon type of corrugation and under structure material used. Panels should be pre-drilled a minimum of 1/16" larger than fastener diameter.

- #10 x 2" Galvanized "polebarr" screw with 1/2" armored Neoprene washer.
- 1-3/4" x .145" Alum. helix nail (screw nail) with Neoprene washer.

UNDER NO CIRCUMSTANCES should panels be allowed to support undistributed loads such as the weight of a human body. Use only approved roof ladders and planking.

INSTALLATION GUIDE FOR CORRUGATED ROOFING PANEL INSTALLATION

BUILDING A PATIO COVER

1. Install concrete slab and footings in accordance with local building code requirements.

NOTE: Building code requirements and available hardware styles will vary depending on where you live and the size of your plan. Make necessary adjustments accordingly. Follow manufacturer's instructions for installing anchor brackets.

2. Assemble ledger board and fasten to existing structure using 5" x 1/2" hex head lag screws. Note: Remove siding from behind ledger board before installing. See diagram 4.

NOTE: Remove siding behind ledger board before mounting ledger to wall. Lag screws must be installed into framing. Use appropriate wall anchors on masonry walls. Space fasteners 16" on center as required.

3. Fasten 4" x 4" posts to concrete slab/footings using approved steel anchor brackets. Use a 4' level and temporary wood bracing to hold posts in an upright level position. (dia 1)
4. Have someone help lift and hold beam for this step. With 4" x 4" posts braced securely, fasten the 4" x 6" beam header to top of posts, using approved steel mounting brackets. See diagram 3.
5. Install permanent knee braces from posts to beam, as building code requires. Remove temporary bracing. See diagram 4.

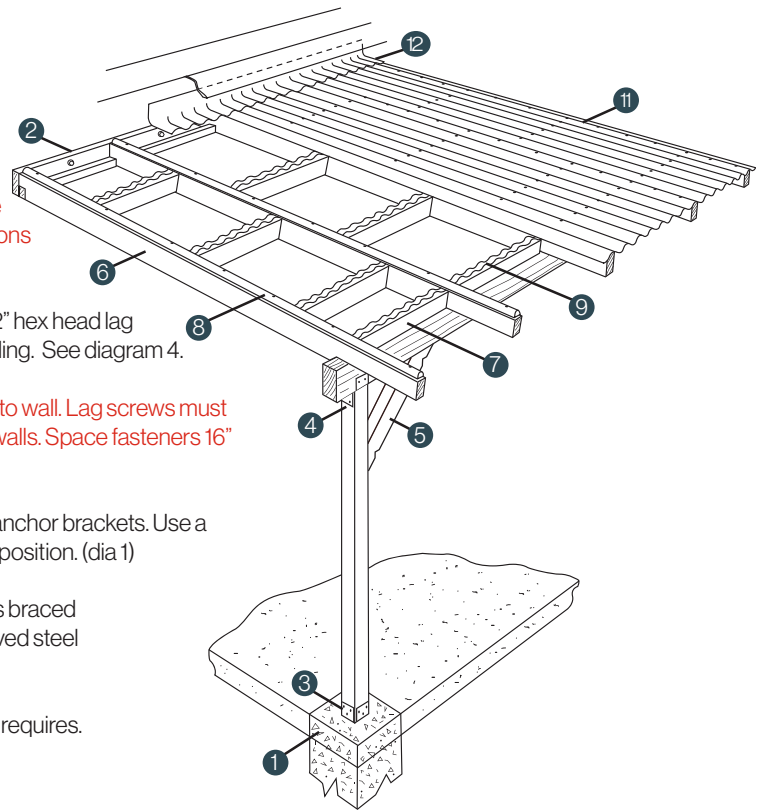

6. Cut and install rafters according to Diagrams 3. Option: approved rafter hangers may be used (if not required) in conjunction with ledger board. Rafters must install parallel.

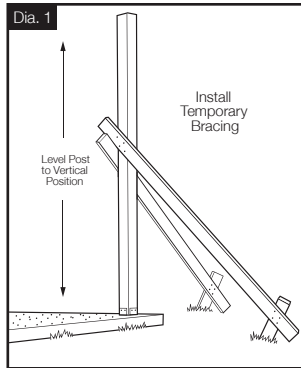

7. For ease of assembly, install 2" x 6" solid blocking as suggested in Diagram 2. Option: blocking can be staggered differently and/or reduced to 2" x 4" to suit personal taste.

8. Nail vertical edge strips to tops of rafters, using 1-1/2" galvanized nails. Hint: drill pilot holes to prevent splitting.

9. Determine necessary cuts for horizontal cross strips.

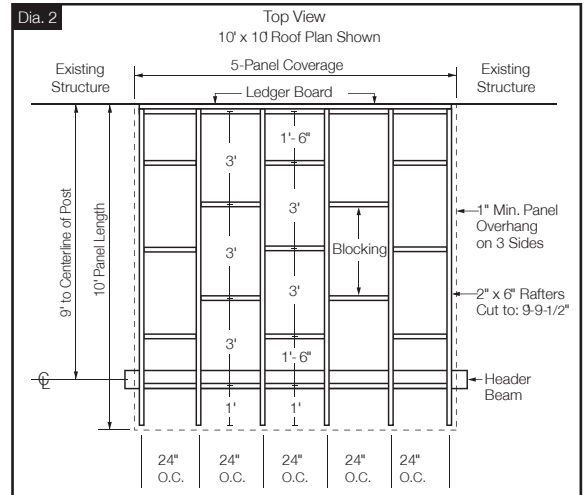

NOTE: Cut crown profiles to match-up with vertical edge strips. (See Diagram 5) Test-fit the first cut strip, using a short piece of corrugated panel. When satisfied, use test piece as a pattern for marking and cutting remaining horizontal pieces. Cut strips 1/4" shorter than needed to allow shifting. Tack horizontal strips to tops of blocking boards using 1" nails in recesses between crowns. Continue checking alignment of strips, using a small strip of corrugated panel.

10. For easier, neater finishing, paint or stain patio cover framing before installing corrugated panels onto roof.

11. Follow corrugated panel installation instructions for fastening panels to roof framing.

12. Install corrugated end wall flashing: Place flashing behind existing siding where possible. Use approved mastic to bond flashing to masonry walls. **WARNING:** Do not step or kneel on corrugated panels without using planks to distribute weight.

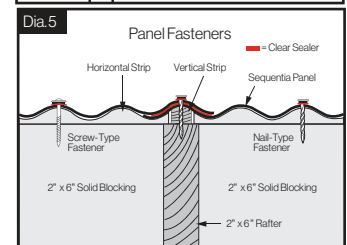
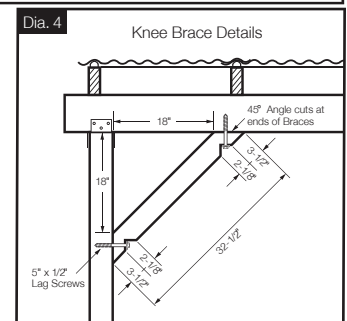
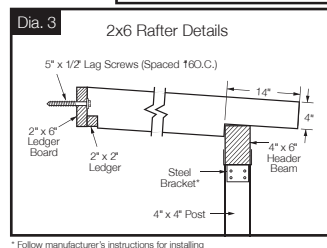

BUILDING A GREENHOUSE

1. Choose a good building site, preferably: level ground with good drainage, sunny area away from large trees, and close access to water and electric
2. Choose desired footings/flooring materials and install accordingly. Make gravel floors 3' larger than greenhouse footprint, make poured concrete floors 8" larger. Wood floors should be 1" smaller than footprint, so corrugated panels can extend below the framed walls.
3. Cut and lay out the front, back, and 2 side wall sections, as shown in Diagrams 1,2, & 3. Assemble framing members, using 10d galvanized nails or 3" construction screws. Drill pilot holes to avoid splitting dry lumber.
4. Erect assembled wall sections on footings/flooring surface. Fasten walls at corners, using 10d galvanized nails or 3" construction screws. Square 4 corners, using a carpenter square or the 3, 4, 5 method.
5. Cut 2x6 ridge board to length and fasten between front and back gables.
6. Mark rafter spacing and install rafters using 10d galvanized nails or 3" construction screws.
7. Cut and install solid blocking between rafters using 10d galvanized
8. Nail vertical edge strips to tops of rafters and vertical wall members, using 1-1/2" galvanized nails. Drill pilot holes to prevent splitting.

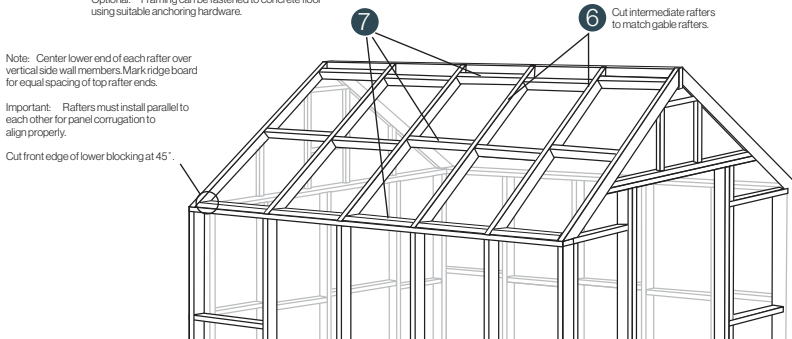
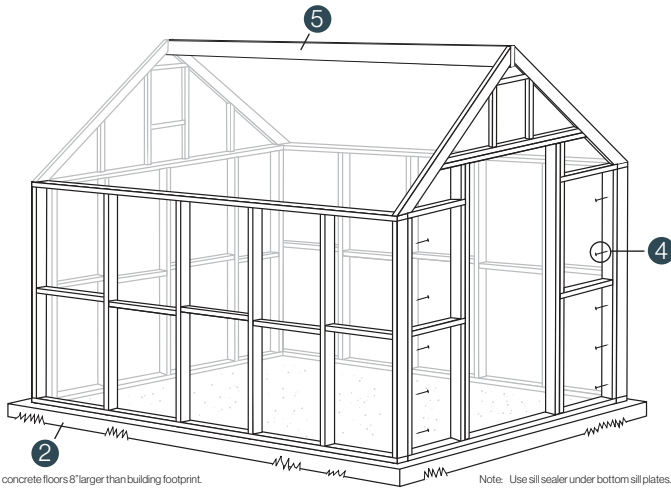
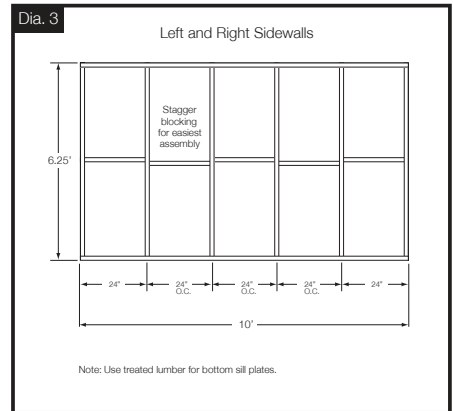
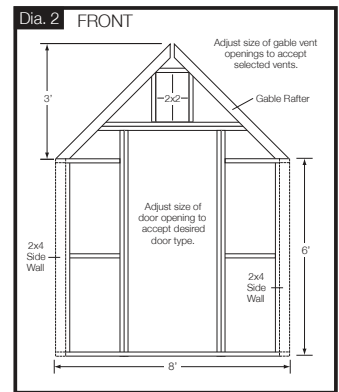
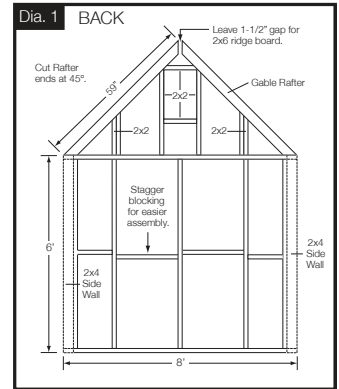

INSTALLATION GUIDE FOR CORRUGATED ROOFING PANEL INSTALLATION

- Determine necessary cuts for horizontal cross strips.

NOTE: Cut crown profiles to match-up with vertical edge strips. Test-fit the first cut strip, using a short piece of corrugated panel. When satisfied, use the test piece as a pattern for marking and cutting additional horizontal strips. Cut strips 1/4" shorter than needed to allow shifting. Tack horizontal strips to all horizontal framing members, using 1" galvanized nails in recesses between crowns. Continue checking alignment of strips, using a small strip of corrugated panel.

- For easier, neater finishing, paint or stain greenhouse framing before installing corrugated panels.
- Follow corrugated panel installation instructions for fastening panels to framing. Install vertical wall panels first. Install roof panels last.
- Install corrugated ridge flashing: use approved mastic or caulk to bond flashing to fiberglass panels. Flashing can be further secured using panel nails or screws and sealer.
- Install gable vents after corrugated panels have been installed. Use layered foam enclosures at top and bottom of vents to fill voids.
- Install assembled custom door or ready-made door.

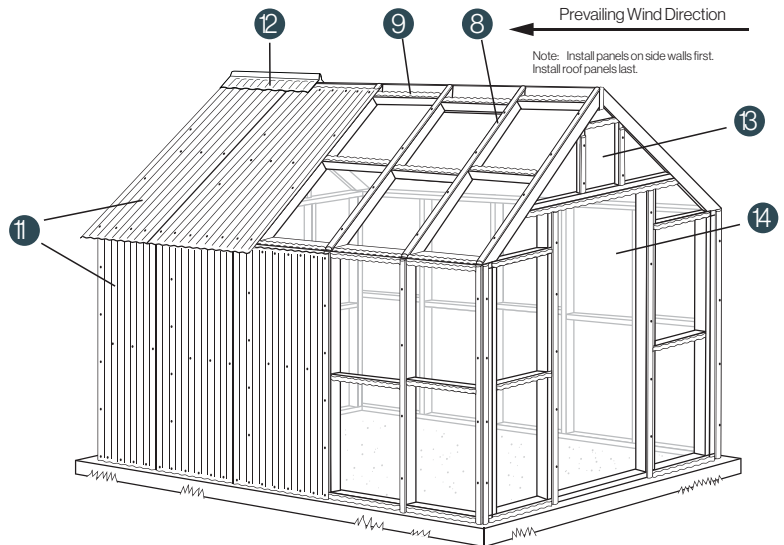

FOR QUESTIONS OR CONCERNS, PLEASE CONTACT:

VALTO Customer Service Department
23525 West Eames Street | Channahon, IL 60410
1.800.435.0080 | 1.815.467.8600

At Valto, we partner with our customers, and through innovation, deliver advanced materials that enhance everyday environments. We succeed through a culture of collaboration, continuous improvement, and excellence. With integrity at our core, we challenge the status quo and pursue innovative approaches that benefit our customers and associates.

Since 1954, Valto Engineered Materials has provided innovative products and services and is a leading provider of FRP composite panels. Our lightweight composite products deliver unsurpassed strength and durability; and we continue to pioneer next level performance in building materials, recreational vehicles, and transportation.

VALTOfrp.com | 1.800.435.0080 | sales@valtoem.com

The following are trademarks of Valto, Inc. or a related company: Glasbord, Glasbond, Kemply, Surfaseal, Sanigridd, Silhouette Trims and Varietex
Form 2715 | Rev. 5 | 09.25 (8848)