

Dowel Bar Splicing System

This system is a two-piece system consisting of male and female threaded rebars that have been upset on the threaded end. Available in reinforcing bar sizes #4 through #11 meeting ASTM A 615 Grade 60 requirements in plain or epoxy finishes.

The manufacturing process ensures that no reduction occurs in the cross-sectional area of the projects specified rebar. It also allows the complete splice to achieve 160% of the rebars 60,000 psi yield strength and develop the full ultimate strength of the specified rebar.

The Dowel-Bar Splicer System offers the contractor many advantages, including eliminating drilling of holes in the forms so rebars can pass through, eliminating any rebar protruding from the concrete and greatly reduces injuries from rebar protruding from the concrete.

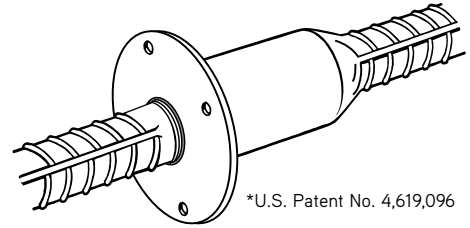

Dowel Bar Splicer

The Dowel Bar Splicer can be furnished straight, with a 90° or 180° hooked end or double-ended. The splicer can also be special-ordered with a reduced diameter washer flange or with the washer flange clipped (in more than one direction, if required) to provide adequate concrete cover or to avoid interference.

The Double-Ended Dowel Bar Splicer can be used to establish a direct load path through a concrete section, thus avoiding multiple hooked rebar and eliminating rebar congestion. The doubled-ended unit can be configured in a "U" shape for special applications.

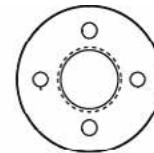
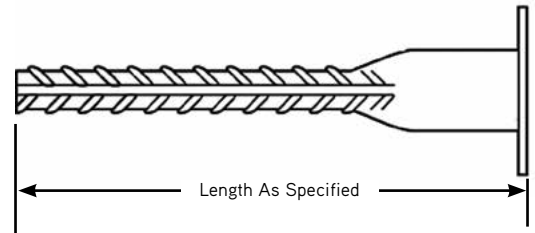

Standard Flange

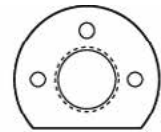

Clipped Flange

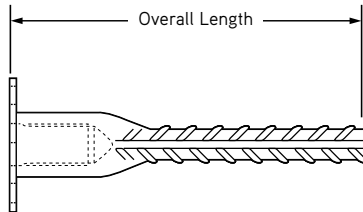

D101A Straight Dowel Bar Splicer

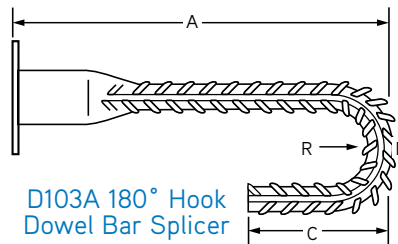

D103A 180° Hook Dowel Bar Splicer

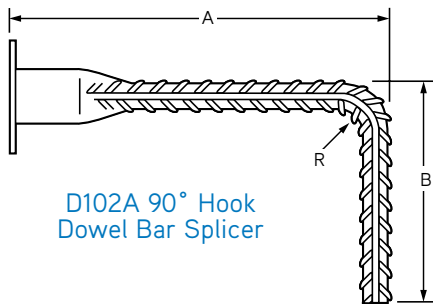

D102A 90° Hook Dowel Bar Splicer

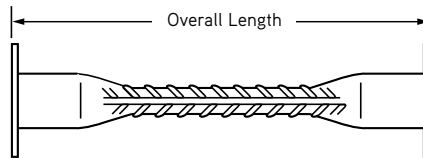

D104A Double-Ended Dowel Bar Splicer

To Order:

Specify (1) quantity, (2) name, (3) rebar number, which is the same number as on project plans, (4) A, B and C dimensions as required, (5) finish.

Example:

800 pcs. DA 101A Straight Dowel Bar Splicer, #4 x 36" long, Epoxy Coated.