

# DEWALT®

## ANCHORS & FASTENERS

### Adhesive Anchor Installation System



HIGH PERFORMANCE

**AC200+™**

**Pure 110+®**

FEATURED

**AC100+ Gold®**

**Pure 50+™**

BASIC

**AC50™**

**PureGP™**

**DEWALT**

**ANCHORS & FASTENERS**



**Introducing The First Cordless**

# DUST X+™

## ANCHOR INSTALLATION SYSTEM



**Adhesive Anchor Installation System**

# DEWALT

## ANCHORS & FASTENERS



### PRODUCTIVITY

\* OSHA COMPLIANT  
ICC-ES APPROVED  
RELIABLE INSTALLATION

**DUST X+™**  
ANCHOR INSTALLATION SYSTEM

**PERFORM  
PROTECT.**

**OSHA COMPLIANT**  
1926.1153









\* System is compliant to the Exposure Control Methods described in Table 1 of 29 CFR 1926.1153 when outlined components are operating and maintained in accordance to manufacturer's instructions.

# DUST X+™

## ANCHOR INSTALLATION SYSTEM



	ADHESIVE ANCHORS					
	HIGH PERFORMANCE		MEDIUM DUTY		BASIC	
						
	Hybrid Acrylic 1:1 & 10:1 Cartridges	High Strength Epoxy 1:1 & 3:1 Cartridges	Hybrid Acrylic 1:1 & 10:1 Cartridges	Epoxy 1:1 Cartridges	Hybrid Acrylic 10:1 Cartridges	Epoxy 1:1 Cartridges
<b>BASE MATERIAL INSTALLATION TEMP. RANGE</b>	14 – 104°F	41 – 104°F	14-104°F	50 – 104°F	5 – 95°F	50 – 104°F
<b>BASE MATERIAL</b>						
Concrete	■	■	■	■	■	■
Lightweight Concrete	■	■	■	■	□	□
Hollow Core Plank		□	□	□		
Grout Filled Concrete Masonry	□	■	■	■	□	□
Hollow Concrete Masonry		■	■	■		
Solid Brick	□	■	■	□	□	□
Hollow Brick		□	■	□		
Unreinforced Masonry		□	■	□		
<b>ANCHOR DIAMETER</b>	3/8" – 1-1/4" #3 – #10 Rebar	3/8" – 1-1/4" #3 – #10- Rebar	3/8" – 1-1/4" #3 – #10 Rebar	3/8" – 1-1/4" #3 – #10 Rebar	3/8" – 1" #3 – #8 Rebar	3/8" – 1" #3 – #8 Rebar
<b>WKG LOAD (CONCRETE)</b>	▲▲▲	▲▲▲	▲▲	▲▲	▲	▲
<b>APPROVALS</b>						
ICC-ES	■	■	■	■		
NSF 61	■	■	■	■		
LEED	■	■	■	■		
Cored Holes		□				
<b>COMPATIBLE WITH DUSTX+™</b>	■	■	□	■	□	□
<b>PRICE PER INSTALLED OZ</b>	\$\$\$	\$\$\$	\$\$	\$\$	\$	\$

# DEWALT

## ANCHORS & FASTENERS



**ICC-ES APPROVED**  
approved for cracked and uncracked concrete

**SEISMIC**  
approved for seismic design categories A-F

**BOND STRENGTH**  
high performance

**CONVENIENT**  
wide installation temperature range with small edge distances and spacings

**EASY TO USE**  
fast hardening adhesive; reliable installation and easy to dispense

**CLEANING**  
hand or power brush clean; or use the Hollow Drill Bit / DustX+™ cleaning method  
(Dust X+™ Approval Pending)

**EMBEDMENT**  
depths ranging from 4d to 20d



**CODE LISTED**  
ICC-ES ESR-4027

### Competitive Comparison

	DeWALT AC200+™	Simpson AT-XP®	Red Head® Epon S7™	Hilti HY 200
Code Approvals	ESR-4027 (Dec. 2016)	ER-263 (Sept. 2016)	ESR-2308 (June 2016)	ESR-3187 (Nov. 2016)
Saturated Concrete	Yes	Yes	Yes	Yes
Seismic	Yes	Yes	Yes	Yes
Bond Strength* (PSI)	1040	1035	726	1120
Min. Cure Time at 68°F	30 Minutes	60 Minutes	30 Minutes	45 Minutes
Hollow Drill Bit Approval	Yes	Yes	No	Yes

\* Bond strength based on 1/2" diameter, cracked concrete, long term loading, dry concrete

AT-XP is a registered trademark of Simpson Strong-Tie Company Inc. Epon and S7 are trademarks of ITW Commercial Construction, North America. Hilti HY200 is a trademark of Hilti Corporation

# AC200+™ Acrylic Adhesive Anchoring System



## Permissible Installation Conditions

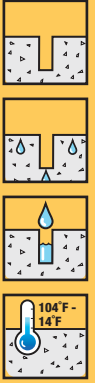

## Dispensing Configurations

Quik-Shot 1:1 Mixing Ratio	Dual Cartridge 10:1 Mixing Ratio

## High Performance Bond Strength

AC200+™ vs. Hilti HY 200  
Factored Tension Loads, Cracked Concrete

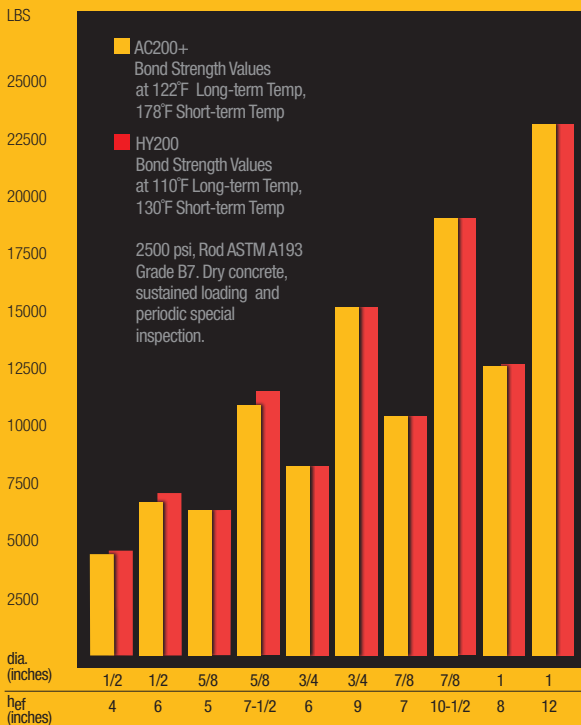

\* Maximum initial battery voltage (measured without a workload) is 20 volts. Nominal voltage is 18.

	PFC1271050	PFC1271150
Dispensing Configurations	9.5oz. Quik-Shot	28oz. Dual Cartridge
Mixing Nozzles		
PFC1641600	✓	✓
20V MAX* Dispensers		
DCE560D1	✓	
DCE595D1		✓
Standard Manual Dispenser		
08437	✓	
08494		✓
High Performance Manual Dispensers		
08479	✓	
08485		
Pneumatic Dispensers		
08496		✓
Premium Brushes (required for max load values)		
See page 20	✓	✓
Premium Piston Plugs		
See page 21	✓	✓
Flex Tubing		
See page 21	✓	✓

# DEWALT®

## ANCHORS & FASTENERS



**CODE LISTED**  
ICC-ES ESR-3298

**SEISMIC**  
approved for seismic design categories A-F

**ICC-ES APPROVED**  
approved for cracked and uncracked concrete, and seismic applications

**BOND STRENGTH**  
high bond strength at 110°F; no reduction in bond strength due to service temperature shifts

**VERSATILE**  
dispensing options - 1:1 and 3:1

**CONVENIENT**  
easy hole cleaning methods and fast curing times



**ICC-ES APPROVED**  
for post-installed rebar



### Competitive Comparison

	DeWALT Pure110+®	Hilti RE500-V3	Simpson SET-3G	Red Head Epon C6+
Code Approval	ESR-3298 (July 2016)	ESR-3814 (Jan 2017)	ESR-4057 (April 2018)	ESR-3577 (August 2016)
Water Filled Holes	Yes	Yes	Yes	Yes
Seismic	Yes	Yes	Yes	Yes
Min. Cure Time at 68°F	8 hrs	7 hrs	24 hrs	7 hrs
Min. Cure Time at 50°F	24 hrs	16 hrs	72 hrs	24 hrs
Hollow Drill Bit Approval	Yes	Yes	Yes	No
Post-Installed Rebar Approval	Yes**	Yes	No	No
Storage Temperature	41°F-86°F	41°F-77°F	45°F-90°F	50°F-77°F

Hilti RE500-V3 is a trademark of Hilti Corporation  
SET-XP is a registered trademark of Simpson Strong-Tie Company Inc.  
Epon and C6+ are trademarks of ITW Commercial Construction, North America.



**Premium Piston Plugs**  
are used for deep embedment depths. The length and dense plastic material provide stability, while the stepped collar fits over flexible plastic tubing.



PFC1640600



# Pure110+<sup>®</sup> Epoxy Adhesive Anchoring System

## Permissible Installation Conditions



## Dispensing Configurations

Quik-Shot 1:1 Mixing Ratio	Dual Cartridge 1:1 Mixing Ratio	Dual Cartridge 3:1 Mixing Ratio

## High Performance Bond Strength

Pure110+<sup>®</sup> vs. Hilti RE 500 V3 vs. Simpson SET-XP

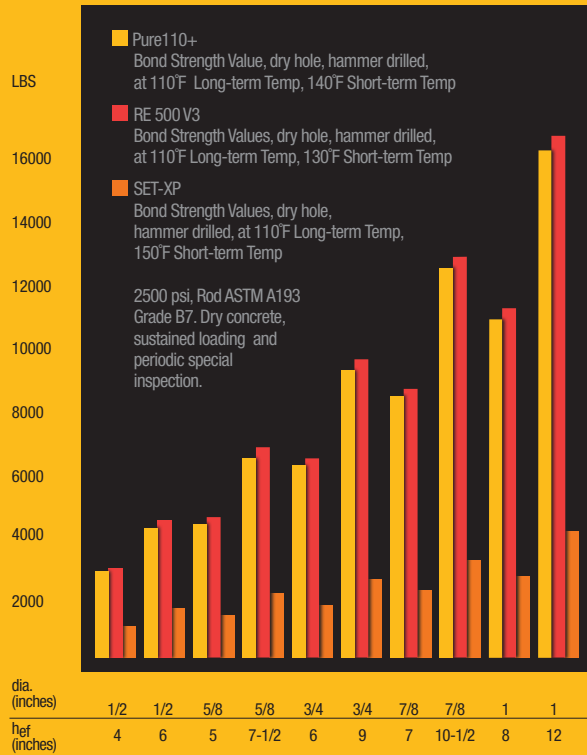

	08310SD	08313SD	08320SD	08321SD	08351SD
Dispensing Configurations	1:1 Formula 9oz. Quik-Shot	3:1 Formula 13oz. Dual Cartridge	3:1 Formula 19.5oz. Dual Cartridge	1:1 Formula 20.5oz. Dual Cartridge	1:1 Formula 50.5oz. Dual Cartridge
Mixing Nozzles					
08609		✓	✓	✓	✓
PFC16641600	✓				
20V MAX* Dispensers					
DCE560D1	✓				
DCE591D1				✓	
DCE593D1		✓			
Standard Manual Dispensers					
08298		✓	✓		
08437	✓				
08409				✓	
High Performance Manual Dispensers					
08479	✓				
08421				✓	
Pneumatic Dispensers					
08438					✓
08459				✓	
08496					
08497SD		✓	✓		
Standard Brushes					
See page 20	✓	✓	✓	✓	✓
Premium Piston Plugs					
See page 21	✓	✓	✓	✓	✓
Flex Tubing					
See page 21	✓	✓	✓	✓	✓

\* Maximum initial battery voltage (measured without a workload) is 20 volts. Nominal voltage is 18.

# DEWALT®

## ANCHORS & FASTENERS



**SEISMIC** approved for seismic design categories A-F

**ICC-ES APPROVED** approved for cracked and uncracked concrete, grouted or hollow masonry and unreinforced masonry

**LOW TEMPERATURE DISPENSING** approved for dispensing down to 14°F

**VERSATILE** low odor formula with quick cure time

**DOT** wide range of listings; 27 states

**CERTIFIED TO NSF/ANSI 61** drinking water system components

### Competitive Comparison, Concrete

	DeWALT AC100+ Gold®	Hilti HY 100	Simpson AT-XP	ITW Epcon S7
Code Approval (Concrete)	ICC-ES ESR-2582 (June 2016)	ICC-ES ESR-3574 (Aug. 2016)	IAMPO ER-263 (Sept. 2016)	ICC-ES ESR-2308 (June 2016)
Cracked Concrete	Yes	Yes	Yes	Yes
Water-Filled Holes	Yes	No	No	Yes
Seismic	Yes	No	Yes	Yes
DOT Rebar Dowel	28 states	Multiple States	Multiple States	Multiple States
Min. Install Temperature	14° F	14° F	14° F	14° F
Min. Cure Time @ 68° F	45 Min	30 Min	60 Min	30 Min
Post-Installed Rebar Approval	Yes	No	No	Yes

Hilti HY 100 is a trademark of Hilti Corporation  
 AT-XP is a registered trademark of Simpson Strong-Tie Company Inc.  
 Epcon and S7 are trademarks of ITW Commercial Construction, North America.

### Competitive Comparison, Masonry

	DeWALT AC100+ Gold®	Hilti HY 70	Simpson AT-XP	ITW Epcon S7
Code Approval (CMU)	ICC-ES ESR-3200 (Dec. 2016)	ICC-ES ESR-2682 (Aug. 2016)	IAMPO ER-281 (Mar. 2016)	-
Grout-filled CMU	Yes	Yes	Yes	No
Top of Walls	Yes	Yes	No	No
Hollow CMU (install w screen tube)	Yes	Yes	No	No
Min. Install Temperature	14° F	14° F	14° F	NA
Min. Cure Time @ 68° F	45 Minutes	1.5 Hours	60 Minutes	NA

\*CMU = concrete masonry

Hilti HY 70 is a trademark of Hilti Corporation  
 AT-XP is a registered trademark of Simpson Strong-Tie Company Inc.  
 Epcon and S7 are trademarks of ITW Commercial Construction, North America.

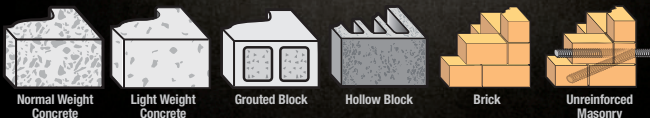

# AC100+ Gold® Acrylic Adhesive Anchoring System



## CODE LISTED

ICC-ES ESR-2582  
ICC-ES ESR-3200  
ICC-ES ESR-4105



### AC100+ Gold® DOT Approval

Alabama	Louisiana	Ohio
Arizona	Maine	Pennsylvania
Arkansas	Maryland	Rhode Island
Colorado	Michigan	Tennessee
Connecticut	Minnesota	Texas
Illinois	Mississippi	Vermont
Indiana	Missouri	Virginia
Iowa	Nebraska	Washington
Kansas	New Jersey	Wisconsin
Kentucky	New York	
Approved on a Project-By Project Acceptance*		
Alaska	New Hampshire	South Dakota
Delaware	North Dakota	West Virginia
Hawaii	South Carolina	Wyoming
Montana		





\*Some states do not maintain an approval list for anchoring systems. For approval, contact local engineering authority for acceptance project by project.

Visit [www.DEWALT.com/approvals](http://www.DEWALT.com/approvals) for the most up-to-date list of approvals

### Permissible Installation Conditions



### Dispensing Configurations

	
	
<b>Quik-Shot 1:1 Mixing Ratio</b>	<b>Dual Cartridge 10:1 Mixing Ratio</b>

	8478SD	8486SD	8490SD
Dispensing Configuration	9.5oz. Quik-Shot	11.5oz. Dual Cartridge	28oz. Dual Cartridge
Mixing Nozzles			
08293	✓	✓	
08294			✓
20V MAX* Dispensers			
DCE560D1	✓		
DCE595D1			✓
Standard Manual Dispenser			
08437	✓	✓	
08494			✓
High Performance Manual Dispensers			
08479	✓		
08485		✓	
Pneumatic Dispensers			
08496			✓
Standard Brushes			
See page 20	✓	✓	✓
Standard Piston Plugs			
See page 21	✓	✓	✓
Flex Tubing			
See page 21	✓	✓	✓

\* Maximum initial battery voltage (measured without a workload) is 20 volts. Nominal voltage is 18.

# DEWALT®

## ANCHORS & FASTENERS



**ICC-ES APPROVED**  
approved for cracked  
and uncracked concrete

**EVALUATED AND  
RECOGNIZED**  
for long and  
short term  
loading



**TESTED**  
for creep  
resistance

**INSTALLATION  
TEMPERATURE**  
can be installed  
in a wide range  
of base material  
temperatures

**DESIGNED**  
specifically  
with road, bridge  
and concrete  
contractors  
in mind

**EVALUATED AND  
RECOGNIZED**  
for freeze/thaw  
performance



### Competitive Comparison

	DeWALT Pure50+™	ITW Epcon G5	Hilti HTE50	ATC HS 200	Simpson SET-XP
Code Approvals	ESR-3576	ESR-1137	No Approval	No Approval	ESR-2508
Wet Hole Suitable	Yes	Yes	No	No	Yes
Full cure at 70°F	8 hrs	24 hrs	24 hrs	24 hrs	24 hrs
Full cure at 50°F	24 hrs	NA	51 hrs	51 hrs	72 hrs
DOT Approvals	31 States	26 States	32 States	32 States	4 States
Hole Cleaning Procedure: Brushing	2X	4X	2X	4X	4X

Epcon and G5 are trademarks of ITW Commercial Construction, North America.  
Hilti HTE500 is a trademark of Hilti Corporation  
HS 200 is a trademark of Adhesives Technology Corp.  
SET-XP is a registered trademark of Simpson Strong-Tie Company Inc.

# Pure50+™ Epoxy Adhesive Anchoring System

Pure50+™ DOT Approval		
Alabama	Kentucky	New Mexico
Arizona	Louisiana	New York
Arkansas	Maine	North Carolina
Colorado	Maryland	Ohio
Connecticut	Michigan	Oklahoma
Florida	Minnesota	Rhode Island
Georgia	Missouri	Tennessee
Idaho	Nebraska	Texas
Indiana	Nevada	Utah
Iowa	New Jersey	Virginia
Kansas		
Pure50+ DOT Approval Pending		
California	Mississippi	
Approved on a Project-By Project Acceptance*		
Alaska	New Hampshire	South Dakota
Delaware	North Dakota	West Virginia
Hawaii	South Carolina	Wyoming
Montana		

\*Some states do not maintain an approval list for anchoring systems. For approval, contact local engineering authority for acceptance project by project.

Visit [www.DeWALT.com/approvals](http://www.DeWALT.com/approvals) for the most up-to-date list of approvals

## Permissible Installation Conditions



## Dispensing Configurations

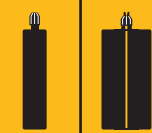

**Quik-Shot**  
1:1  
Mixing  
Ratio

**Dual Cartridge**  
1:1  
Mixing  
Ratio

	08600	08605	08651
Dispensing Configurations	9oz. Quik-Shot	20.5oz. Dual Cartridge	50.5oz. Dual Cartridge
Mixing Nozzles			
PFC16641600	✓		
08294		✓	
08609			✓
20V MAX® Dispensers			
DCE560D1	✓		
DCE591D1		✓	
Standard Manual Dispensers			
08437	✓		
08409		✓	
High Performance Manual Dispensers			
08479	✓		
08421		✓	
Pneumatic Dispensers			
08438			✓
08459		✓	
Standard Brushes			
See page 20	✓	✓	✓
Premium Piston Plugs			
See page 21	✓	✓	✓
Flex Tubing			
See page 21	✓	✓	✓

\* Maximum initial battery voltage (measured without a workload) is 20 volts. Nominal voltage is 18.

# DEWALT

## ANCHORS & FASTENERS

### AC50™ Acrylic Adhesive Anchoring System

ASTM C 881  
Type I, II, IV & V  
Grade 3  
(Class A & B)



### PureGP™ Epoxy Adhesive Anchoring System

ASTM C 881 &  
AASHTO M235,  
Types I, II, IV  
and V Grade 3,  
Classes B & C



**DESIGNED**  
for use with  
threaded rod  
and rebar

**CURES**  
down to  
5° F

**INSTALLATION  
TEMPERATURE**  
installs in a  
wide range of  
material  
temperatures

**EVALUATED AND  
RECOGNIZED**  
for long and  
short term  
loading



#### Dispensing Configurations



Dual Cartridge  
10:1 Mixing Ratio

#### Permissible Installation Conditions



Dispensing Configuration	8497 28oz Dual Cartridge
Mixing Nozzles	
08294	✓
20V MAX* Dispensers	
DCE595D1	✓
20V MAX* Dispensers	
08494	✓
Pneumatic Dispenser	
08496	✓

\* Maximum initial battery voltage (measured without a workload) is 20 volts. Nominal voltage is 18.

#### Dispensing Configurations



Dual Cartridge  
1:1 Mixing Ratio

#### Permissible Installation Conditions



Dispensing Configurations	08821 20.5oz. Dual Cartridge
Mixing Nozzles	
08294	✓
20V MAX* Dispensers	
DCE591D1	✓
Standard Manual Dispenser	
8409	✓
High Performance Manual Dispenser	
08421	✓



# Cordless Dispensing Tools For Adhesive Cartridges

## PRODUCTIVE

up to 24 tubes per battery charge at room temperature

## SPEED DIAL

controls the flow rate of the adhesive being dispensed

## DOSAGE DIAL

controls the length of time that the adhesive is being dispensed



## AVAILABLE IN 4 SIZES

- DCE591D1\* Epoxy Dispenser 1:1 Cartridges
- DCE593D1\* Epoxy Dispenser 3:1 Cartridges
- DCE595D1\* Acrylic Dispenser 10:1 Cartridges
- DCE560D1\* 20V Quik-Shot Single Cartridge

\* Also available without battery. Add suffix B (Bare) to item number

**20V MAX\***  
Battery System

\*For 20V MAX\* Maximum initial battery voltage measured without a workload is 20 volts. Nominal voltage is 18.

Available Dispensing Configurations			
Quik-Shot 1:1 Mixing Ratio	Dual Cartridge 1:1 Mixing Ratio	Dual Cartridge 3:1 Mixing Ratio	Dual Cartridge 10:1 Mixing Ratio





## ANCHORS & FASTENERS

### 1-9/16" FLEXVOLT® SDS MAX Rotary Hammer DCH481



**FLEXVOLT®** technology; 60V Max\* battery system

\* Maximum initial battery voltage measured without a workload is 60 volts. Nominal voltage is 54.

**RECOMMENDED**  
impact energy  
for SDS Max  
hollow bits



**DCB1800B**  
**PORTABLE POWER STATION™**  
and parallel battery charger

### 1-3/4" SDS MAX Combination Hammer D25604K



**RECOMMENDED**  
impact energy  
for SDS Max  
hollow bits

**ROTATION CONTROL**  
anti-rotation E-Clutch®



#### DCH481X2

Bit Style:	SDS MAX
Optimal Drilling Range:	1/2" - 1-1/8"
Impact Energy (Joules):**	6.1
RPM:	0 - 540
BPM:	0 - 3,150
Rotation Control:	E-Clutch®
Battery Voltage:	60V MAX* (20V MAX*)
Battery Ah:	3.0 (9.0)
Tool Weight:	14.33lbs
Vibration Control:	SHOCKS™
Vibration:	9.4 m/s <sup>2</sup>
Service Warranty:	2 Years

#### D25604K

Bit Style:	SDS MAX
Optimal Drilling Range:	1/2" - 1-3/8"
Impact Energy (Joules):**	8.0
Rotation Control:	E-Clutch®
Amps:	13.5
Tool Weight:	15.1lbs
Vibration Control:	SHOCKS™
Vibration:	9.1 m/s <sup>2</sup>
Service Warranty:	2 Years

\*\*According to EPTA - Procedure 05/2009





# DUST X+™

## ANCHOR INSTALLATION SYSTEM

**PERFORM  
PROTECT.**

**USE WITH DWV012**  
for OSHA silica dust  
Table 1 Compliance

\* System is compliant to the Exposure Control Methods described in Table 1 of 29 CFR 1926.1153 when outlined components are operating and maintained in accordance to manufacturer's instructions.

**OSHA COMPLIANT**  
1926.1153

**SDS MAX  
Y-CUTTER  
CARBIDE**

for positioning  
and hole starting

**HOLLOW  
DRILL BIT**

bit extracts  
while drilling  
for less dust,  
fast holes

**NEWLY  
ADDED LONG  
LENGTHS**

up to 39-3/8"  
usable length  
available for  
5/8" - 1-1/2"  
diameters



**AIRLOCK™**  
Adapter allows for quick,  
easy and durable  
connection  
between 1-1/4"  
vacuum hose  
and various  
DEWALT tools  
and shrouds















**AIRLOCK™ ADAPTER**  
connects directly  
to DEWALT's  
Airlock System  
forming a secure,  
locking connection  
between bit and  
dust extractor

**SDS MAX AND  
SDS PLUS**  
sizes available





## ANCHORS & FASTENERS

	CAT #	DESCRIPTION
	DCH481X2	1-9/16" Flexvolt® SDS Max* Brushless Combination Hammer w/ 9Ah Battery
	DCH263R2DH	1-1/8" D-Handle SDS+ Brushless Rotary Hammer w/Dust Extractor 20V Max*
	DCH273P2	1" SDS+ Brushless Rotary Hammer w/5Ah Battery 20V Max*
	DCH273P2DH0	1" SDS+ Brushless Rotary Hammer w/Dust Extractor 20V Max*
	DCH293R2	1-1/8" SDS+ Brushless Rotary Hammer 3.5J w/ 6Ah Battery 20V Max*
	DCH293R2DH	1-1/8" SDS+ Brushless Rotary Hammer 3.5J w/ 9Ah Battery 20V Max*
	DWV012	10 Gallon Wet/Dry HEPA/RRP Dust Extractor DWV9402 Fleece bag (5 pack) for DEWALT dust extractors DWV9316 Replacement Anti-Static Hose DWV9320 Replacement HEPA Filter Set (Type 1)
	DWH050K	Dust Extraction with two interchangeable drilling heads
	DCB1800B	1800 Watt Portable Power Station & Parallel Battery Charger
	DCB609	20V/60V Max* Flexvolt® 9.0Ah Battery
	DCB205	20V Max* Premium XR 5.0Ah Lithium Ion Battery Pack
	DCB206	20V Max* Premium XR 6.0Ah Lithium Ion Battery Pack
	D25604K	1-3/4" SDS Max* Combination Hammer / Corded E-Clutch®

\*For 20V MAX\* Maximum initial battery voltage measured without a workload is 20 volts. Nominal voltage is 18. \*For 60V MAX\* Maximum initial battery voltage measured without a workload is 60 volts. Nominal voltage is 54.

# Hole Preparation

## Drilling Tools, Bits & Dust Management

### SDS Max 4-Cutter Carbide Drill Bits



CAT #	DIA	USABLE LENGTH	OVERALL LENGTH
DW5806	5/8"	8"	13-1/2"
DW5809	5/8"	16"	21-1/2"
DW5807	5/8"	31"	36"
DW5808	11/16"	16"	21-1/2"
DW5810	3/4"	8"	13-1/2"
DW5812	3/4"	16"	21-1/2"
DW5813	3/4"	31"	36"
DW5814	13/16"	16"	21-1/2"
DW5815	7/8"	8"	13-1/2"
DW5816	7/8"	16"	21-1/2"
DW5851	7/8"	31"	36"
DW5817	27/32"	16"	21-1/2"
DW5818	1"	8"	13-1/2"
DW5819	1"	16"	22-1/2"
DW5852	1"	24"	29"
DW5820	1"	31"	36"
DW5821	1-1/8"	10"	15"
DW5822	1-1/8"	18"	22-1/2"
DW5853	1-1/8"	24"	29"
DW5854	1-1/8"	31"	36"
DW5824	1-1/4"	10"	15"
DW5825	1-1/4"	18"	22-1/2"

### SDS+ Full Head Carbide Drill Bits





CAT #	DIA	USABLE LENGTH	OVERALL LENGTH
DW5502	3/16"	2"	4-1/2"
DW5503	3/16"	4"	6-1/2"
DW5504	3/16"	5"	8-1/2"
DW5506	3/16"	10"	12"
DW5512	7/32"	8"	10"
DW5517	1/4"	4"	6"
DW5518	1/4"	6"	8-1/2"
DW55200	1/4"	10"	12"
DW5521	1/4"	12"	14"
DW5524	5/16"	4"	6"
DW5526	5/16"	10"	12"
DW5527	3/8"	4"	6-1/2"
DW5529	3/8"	8"	10"
DW55300	3/8"	10"	12"
DW5531	3/8"	16"	18"
DW5537	1/2"	4"	6"
DW5538	1/2"	8"	10-1/2"
DW5539	1/2"	10"	12"
DW5540	1/2"	16"	18"

### SDS+ 4-Cutter Carbide Drill Bits



CAT #	DIA	USABLE LENGTH	OVERALL LENGTH
DW5471	5/8"	8"	10"
DW5472	5/8"	16"	18"
DW5474	3/4"	8"	10"
DW5475	3/4"	16"	18"
DW5477	7/8"	8"	10"
DW5478	7/8"	16"	18"
DW5479	1"	8"	10"
DW5480	1"	16"	18"
DW5481	1-1/8"	8"	10"
DW5482	1-1/8"	6"	18"

### Hollow Drill Bits

	CAT #	DIA	OVERALL LENGTH	USABLE LENGTH
SDS+	DWA54012	1/2"	14-1/2"	9-3/4"
	DWA54916	9/16"	14-1/2"	9-3/4"
	DWA54058	5/8"	14-1/2"	9-3/4"
	DWA54034	3/4"	14-1/2"	9-3/4"
SDS MAX	DWA58058	5/8"	23-3/4"	15-3/4"
	DWA58958	5/8"	47-1/4"	39-3/8"
	DWA58116	11/16"	23-3/4"	15-3/4"
	DWA58034	3/4"	23-3/4"	15-3/4"
	DWA58934	3/4"	47-1/4"	39-3/8"
	DWA58078	7/8"	23-3/4"	15-3/4"
	DWA58978	7/8"	47-1/4"	39-3/8"
	DWA58001	1"	23-3/4"	15-3/4"
	DWA58901	1"	47-1/4"	15-3/4"
	DWA58118	1-1/8"	23-3/4"	15-3/4"
	DWA58918	1-1/8"	47-1/4"	39-3/8"
	DWA58114	1-1/4"	47-1/4"	39-3/8"
	DWA58112	1-1/2"	47-1/4"	39-3/8"
	DWA58138	1-3/8"	47-1/4"	39-3/8"



## ANCHORS & FASTENERS

### Adhesive Cartridges

CAT #	DESCRIPTION	QTY	MSTR	PAL
08310SD	Pure110+ 1:1 Ratio 9oz QS Cartridge	12	36	648
08321SD	Pure110+ 1:1 Ratio 21oz Dual Cartridge	12	-	360
08351SD	Pure110+ 1:1 Ratio 51oz Dual Cartridge	5	-	150
08313SD	Pure110+ 3:1 Ratio 13oz Dual Cartridge	12	-	624
08320SD	Pure110+ 3:1 Ratio 20oz Dual Cartridge	12	-	360
PFC1271050	AC200+ 10oz QS Cartridge	12	36	648
PFC1271150	AC200+ 28oz Dual Cartridge	8	-	240
8478SD	AC100+ Gold 10oz QS Cartridge	12	36	648
8486SD	AC100+ Gold 12oz Dual Cartridge	12	-	540
8490SD	AC100+ Gold 28oz Dual Cartridge	8	-	240
08600	Pure50+ 9oz QS Cartridge	12	36	648
08605	Pure50+ 21oz Dual Cartridge	12	-	360
08651	Pure50+ 51oz Dual Cartridge	5	-	150
08497	AC50 28oz Dual Cartridge	8	-	240
08821	PureGP 21oz Dual Cartridge	12	-	360

### Dispensers

CAT #	DESCRIPTION	QTY	MSTR
<i>DCE591D1</i>			
DCE560D1	20V Quik-Shot Adhesive Dispenser Kit	1	-
DCE560B	20V Quik-Shot Adhesive Dispenser Bare	1	-
DCE591D1	20V Epoxy Dispenser 1:1 20.5oz Kit	1	-
DCE591B	20V Epoxy Dispenser 1:1 20.5oz Bare	1	-
DCE593D1	20V Epoxy Dispenser 3:1 13/19.5oz	1	-
DCE593B	Epoxy Dispenser 3:1 13/19.5oz Bare	1	-
DCE595D1	Acrylic Dispenser 10:1 28oz Kit	1	-
DCE595B	Acrylic Dispenser 10:1 28oz Bare	1	-
<i>08437</i>			
08409	Standard Manual Dispenser 20.5oz	1	8
08437	Standard Manual Dispenser 9/10oz	1	12
08494	Standard Manual Dispenser 28oz	1	10
<i>08479</i>			
08298	High Performance Manual Dispenser 13oz / 19.5oz	1	5
08421	High Performance Manual Dispenser 20.5oz	1	10
08479	High Performance Manual Dispenser 9/10oz	1	12
08485	High Performance Manual Tool 8, 9.5, 11.5 oz	1	20
<i>08496</i>			
08459	Pneumatic Dispenser 20.5oz	1	-
08496	Pneumatic Dispenser 28oz	1	1
8497SD	Pneumatic Dispenser 13 / 19.5oz	1	6
08438	Pneumatic Dispenser 50.5oz	1	-



### Hole Cleaning Tools and Accessories

CAT #	DESCRIPTION	QTY
<i>PFC1671100</i>		<b>Required for AC200+</b>
PFC1671050	Steel Premium Brush For 7/16" Hole	1
PFC1671100	Steel Premium Brush For 1/2" Hole	1
PFC1671150	Steel Premium Brush For 9/16" Hole	1
PFC1671200	Steel Premium Brush For 5/8" Hole	1
PFC1671225	Steel Premium Brush For 11/16" Hole	1
PFC1671250	Steel Premium Brush For 3/4" Hole	1
PFC1671300	Steel Premium Brush For 7/8" Hole	1
PFC1671350	Steel Premium Brush For 1" Hole	1
PFC1671400	Steel Premium Brush For 1-1/8" Hole	1
PFC1671450	Steel Premium Brush For 1-3/8" Hole	1
PFC1671500	Steel Premium Brush For 1-1/2" Hole	1
PFC1671000	Premium Manual Brush Wood Handle	1
PFC1671010	Premium Brush Extension	1
PFC1671820	Premium Steel Brush Extension 12"	1
PFC1671830	Premium Steel Brush SDS Adapter	1
PFC1671960	Premium Steel Brush Drill Chuck Adapter	1
<i>08284</i>		
08275	Wire Brush For 5/8" ANSI Hole, No. 4 Rebar	1
08284	Wire Brush For 7/16" ANSI Hole	1
08287	Wire Brush For 7/8" ANSI Hole	1
08285	Wire Brush For 9/16" ANSI Hole	1
08278	Wire Brush For 3/4" ANSI Hole	1
08286	Wire Brush For 11/16" ANSI Hole	1
08288	Wire Brush For 1" ANSI Hole	1
08289	Wire Brush For 1-1/8" ANSI Hole	1
08290	Wire Brush For 1-3/8" ANSI Hole	1
08291	Wire Brush For 1-1/2" ANSI Hole	1
08299	Wire Brush For 1-3/4" Hole, No. 11 Rebar	1
08282	Brush Extension 12"	1
08283	SDS Plus Adapter For Wire Brush	1
08296	Jacobs Chuck Adapter	1
<i>07933</i>		
07933	Nylon Brush For 3/4" ANSI Hole	1
07932	Nylon Brush For 9/16" ANSI Hole	1
07931	Nylon Brush For 7/16" ANSI Hole	1
07934	Nylon Brush For 3/4" ANSI Hole	1
07935	Nylon Brush For 1-1/4" ANSI Hole	1
52073	Adhesive Cleaning Kit	1
<i>08292</i>		
08292	Air Nozzle W/Extension	1
<i>08280</i>		
08280	Hand Pump / Dust Blower 25oz.	1

\*For 20V MAX\* Maximum initial battery voltage measured without a workload is 20 volts. Nominal voltage is 18.

# Adhesive Installation Cartridges and Delivery Accessories

## Adhesive Piston Plugs

CAT #	DESCRIPTION	ANSI BIT DIA	ROD DIA	REBAR SIZE	QTY
<i>08301</i>					
08302	9/16" Plug	9/16"	1/2"	#4	10
08304	5/8" Plug	5/8"	-	#4	10
08258	11/16" Plug	11/16"	5/8"	#5	10
08259	3/4" Plug	3/4"	5/8"	#5	10
08300	7/8" Plug	7/8"	3/4"	#6	10
08301	1" Plug	1"	7/8"	#7	10
08303	1-1/8" Plug	1-1/8"	1"	#8	10
08305	1-3/8" Plug	1-3/8"	1-1/4"	#9	10
08309	1-1/2" Plug	1-1/2"	-	#10	10
<i>PFC1691540</i>					<b>NEW!</b>
PFC1691510	Premium Plug	5/8" Hole	-	#4	10
PFC1691520	Premium Plug	3/4" Hole	5/8"	#5	10
PFC1691530	Premium Plug	7/8 Hole	3/4"	#6	10
PFC1691540	Premium Plug	1" Hole	7/8"	#7	10
PFC1691550	Premium Plug	1-1/8" Hole	1"	#8	10
PFC1691560	Premium Plug	1-3/8" Hole	1-1/4"	#9	10
PFC1691570	Premium Plug	1-1/2" Hole	-	#10	10
PFC1691580	Premium Plug	1-3/4" Hole	1-1/2"	#11	10

## Plastic Screen Tubes

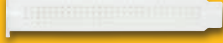
NUMBER	DESCRIPTION	DRILL DIA	QTY
<i>08310</i>			
08310	3/8" x 3-1/2"	9/16"	25
08311	3/8" x 6"	9/16"	25
08313	3/8" x 8"	9/16"	25
08315	1/2" x 3-1/2"	3/4"	25
08317	1/2" x 6"	3/4"	25
08321	5/8" x 6"	7/8"	25
08323	3/4" x 6"	1"	10

## Stainless Steel Screen Tubes

NUMBER	DESCRIPTION	DRILL DIA	QTY
<i>07967</i>			
07960	1/4" x 2"	3/8"	25
07862	1/4" x 6"	3/8"	25
07864	1/4" x 8"	3/8"	25
07856	3/8" x 2"	1/2"	25
07961	3/8" x 3-1/2"	1/2"	25
07962	3/8" x 6"	1/2"	25
07963	3/8" x 8"	1/2"	25
07964	3/8" x 10"	1/2"	25
07959	3/8" x 12"	1/2"	25
07857	1/2" x 2"	5/8"	25
07965	1/2" x 3-1/2"	5/8"	25
07966	1/2" x 6"	5/8"	25
07967	1/2" x 8"	5/8"	25
07968	1/2" x 10"	5/8"	25
07858	5/8" x 2"	3/4"	25
07969	5/8" x 4-1/2"	3/4"	20
07970	5/8" x 6"	3/4"	20
07971	5/8" x 8"	3/4"	20
07972	5/8" x 10"	3/4"	20
07859	3/4" x 2"	7/8"	25
07855	15/16" x 2"	1"	25

## Mixing Nozzles and Nozzle Extensions

CAT #	DESCRIPTION	QTY	MSTR
<i>PFC1641600</i>			<b>Required for AC200+</b>
PFC1641600	Mixing Nozzle for all AC200+ sizes, Pure110+ 9oz and Pure50+ 9oz	2	24
08609	Extra High Flow Mixing Nozzle	2	24
08293	Mixing Nozzle for AC100+ Gold 9.5 & 11.5 oz	2	24
08294	Mixing Nozzle	2	24
<i>PFC1640600</i>			
08281	8" Extension	1	12
08297	18" Extension	1	12
PFC1640600	Flexible Extension Hose 25 Ft	1	12

### Adhesive Installation System: Drill Bits

			20V MAX* SDS Plus Rotary Hammers Drill Bits					Flexvolt® SDS Max Drill Bits	SDS Max Combination Hammer (Corded) Drill Bits
*For 20V MAX* Maximum initial battery voltage measured without a workload is 20 volts. Nominal voltage is 18.									
ROD/REBAR SIZE	HOLE SIZE	EMBEDMENT	DCH273P2DHO 1" L-SHAPE	DCH263R2DH 1-1/8" D-HANDLE	DCH293R2DH 1-1/8" L-SHAPE W/ E-CLUTCH	DCH481X2 1-9/16" W/ E-CLUTCH	D25481K 1-9/16" CORDED		
			SDS+	SDS+	SDS+	SDS MAX			
3/8" or #3	1/2"*	4"	DW5537	DW5437	DW5537				
3/8" or #3	1/2"*	8"	DW5538	DW5438	DW5538				
3/8" or #3	1/2"*	10"	DW5539	DW5439	DW5539				
3/8" or #3	1/2"*	16"	DW5540	DW5440	DW5540				
3/8" or #3	1/2"*	22"	DW55410	DW5441	DW55410				
1/2"	5/8"***	6"	DW5471	DW5446	DW5471		DW5806		
1/2" or #4	5/8"***	8"	DW5471	DW5447	DW5471		DW5806		
1/2" or #4	5/8"***	16"	DW5472	DW5448	DW5472		DW5809		
1/2" or #4"	5/8"***	22"		DW5449			DW5807		
1/2" or #4	5/8"***	31"					DW5807		
5/8" or #5	3/4"	6"			DW5474		DW5810		
5/8" or #5	3/4"	10"			DW5475		DW5812		
5/8" or #5	3/4"	16"			DW5475		DW5812		
5/8" or #5	3/4"	22"					DW5813		
3/4" or #6	7/8"	6"			DW5477		DW5815		
3/4" or #6	7/8"	10"			DW5478		DW5816		
3/4" or #6	7/8"	16"			DW5478		DW5816		
7/8" or #7	1"	8"			DW5479		DW5818		
7/8" or #7	1"	16"			DW5480		DW5819		
7/8" or #7	1"	24"					DW5852		
7/8" or #7	1"	31"					DW5820		
1" or #8	1-1/8"	8"			DW5481		DW5821		
1" or #8	1-1/8"	16"			DW5482		DW5822		
1" or #8	1-1/8"	24"					DW5853		
1" or #8	1-1/8"	31"					DW5854		

\* 7/16" may be needed in some circumstance for 3/8" rod

\*\* 9/16" may be needed in some circumstance for 1/2" rod

# The System

			Adhesive Installation System: Hollow Drill Bits					Accessories			
			20V MAX* SDS Plus Rotary Hammers Hollow Drill Bit			Flexvolt® SDS Max Hollow Drill Bit	SDS Max Combination Hammer (Corded) Hollow Drill Bit				
ROD/ REBAR SIZE	HOLE SIZE	EMBD.	DCH273P2 1" L-SHAPE	DCH263R2 1-1/8" D-HANDLE	DCH293R2 1-1/8" L-SHAPE W/ E-CLUTCH	DCH481X2 1-9/16" W/ E-CLUTCH	D25481K 1-9/16" CORDED	PREMIUM PISTON PLUGS	STANDARD PISTON PLUGS	PREMIUM BRUSH	STANDARD BRUSH
			SDS PLUS HOLLOW DRILL BIT			SDS MAX HOLLOW DRILL BIT					
3/8" or #3	1/2"	4"	DWA54012	DWA54012	DWA54012			08302-PWR		PFC1671100	
3/8" or #3	1/2"	8"	DWA54012	DWA54012	DWA54012			08302-PWR		PFC1671100	
3/8" or #3	1/2"	10"	DWA54012	DWA54012	DWA54012			08302-PWR		PFC1671100	
3/8" or #3	1/2"	16"						08302-PWR		PFC1671100	
3/8" or #3	1/2"	22"						08302-PWR		PFC1671100	
1/2"	5/8"	6"	DWA54058	DWA54058	DWA54058	DWA58058	DWA58058	PFC1691510	08258-PWR	PFC1671200	08275-PWR
1/2" or #4	5/8"	8"	DWA54058	DWA54058	DWA54058	DWA58058	DWA58058	PFC1691510	08258-PWR	PFC1671200	08275-PWR
1/2" or #4	5/8"	16"	DWA54058	DWA54058	DWA54058	DWA58058	DWA58058	PFC1691510	08258-PWR	PFC1671200	08275-PWR
1/2" or #4"	5/8"	22"				DWA58958	DWA58958	PFC1691510	08258-PWR	PFC1671200	08275-PWR
1/2" or #4	5/8"	31"				DWA58958	DWA58958	PFC1691510	08258-PWR	PFC1671200	08275-PWR
5/8" or #5	3/4"	6"		DWA54034	DWA54034	DWA58034	DWA58034	PFC1691520	08259-PWR	PFC1671250	08278-PWR
5/8" or #5	3/4"	10"		DWA54034	DWA54034	DWA58034	DWA58034	PFC1691520	08259-PWR	PFC1671250	08278-PWR
5/8" or #5	3/4"	16"				DWA58034	DWA58034	PFC1691520	08259-PWR	PFC1671250	08278-PWR
5/8" or #5	3/4"	22"				DWA58934	DWA58934	PFC1691520	08259-PWR	PFC1671250	08278-PWR
3/4" or #6	7/8"	6"				DWA58078	DWA58078	PFC1691530	08300-PWR	PFC1671300	08287-PWR
3/4" or #6	7/8"	10"				DWA58078	DWA58078	PFC1691530	08300-PWR	PFC1671300	08287-PWR
3/4" or #6	7/8"	16"				DWA58078	DWA58078	PFC1691530	08300-PWR	PFC1671300	08287-PWR
7/8" or #7	1"	8"				DWA58001	DWA58001	PFC1691540	08301-PWR	PFC1671350	08288-PWR
7/8" or #7	1"	16"				DWA58001	DWA58001	PFC1691540	08301-PWR	PFC1671350	08288-PWR
7/8" or #7	1"	24"				DWA58901	DWA58901	PFC1691540	08301-PWR	PFC1671350	08288-PWR
7/8" or #7	1"	31"				DWA58901	DWA58901	PFC1691540	08301-PWR	PFC1671350	08288-PWR
1" or #8	1-1/8"	8"				DWA58118	DWA58118	PFC1691550	08303-PWR	PFC1671400	08288-PWR
1" or #8	1-1/8"	16"				DWA58118	DWA58118	PFC1691550	08303-PWR	PFC1671400	08288-PWR
1" or #8	1-1/8"	24"				DWA58918	DWA58918	PFC1691550	08303-PWR	PFC1671400	08288-PWR
1" or #8	1-1/8"	31"				DWA58918	DWA58918	PFC1691550	08303-PWR	PFC1671400	08288-PWR

**DeWALT****ANCHORS & FASTENERS**

# Adhesive Anchor Installation System

DeWALT Locations		Field Service	DEWALT Tool Service	Anchor Distribution Ctr.
ALASKA	Anchorage	907-561-7181		
ALABAMA	Mobile	251-602-1000		
ARKANSAS	North Little Rock	501-372-3040		
ARIZONA	Phoenix	602-437-1200		
	Phoenix	602-431-8024		
	Phoenix	480-710-5225		
CALIFORNIA	Anaheim	714-414-0369		
	Anaheim	206-679-4218		
	Anaheim	818-395-7325		
	Hayward	(650)391-5403		
	Ontario	909-930-1437		
	Ontario	909-214-4183		
	Ontario	951-258-2903		
	Sacramento	916-419-7259		
	Sacramento	916-291-5367		
	San Diego	858-279-2011		
	Tustin	714-731-2500		
COLORADO	Denver	303-922-8325		
	Denver	303-922-9202		
	Denver	720-439-1100		
CONNECTICUT	Wethersfield	860-563-5800		
FLORIDA	Davie	954-321-6635		
	Davie	786-545-5881		
	Orlando	407-657-0474		
	Orlando	321-544-9284		
	Tampa	813-884-0434		
	Tampa	314-620-0244		
	W. Palm Beach	561-689-3247		
GEORGIA	Norcross	770-246-1710		
	Norcross	678-966-0000		
	Norcross	770-307-6867		
HAWAII	Honolulu	808-842-9925		
IOWA	Des Moines	515-270-1340		
ILLINOIS	Addison	630-521-1097		
	Addison	630-960-3156		
	Addison	630-461-3078		
	Addison	630-461-3076		
	Addison	708-675-9721		
INDIANA	Indianapolis	317-243-8308		
KANSAS	Overland Park	913-495-4330		
	Overland Park	816-349-9573		
KENTUCKY	Louisville	502-380-3748		
LOUISIANA	Baton Rouge	225-296-3191		
	Baton Rouge	469-647-1551		
	Elmwood	504-734-3413		
	Elmwood	504-872-2902		
MASSACHUSETTS	Westwood	781-329-3407		
	Westwood	347-602-2617		
MARYLAND	Capitol Heights	301-773-1722		
	Capitol Heights	301-333-0865		
	Capitol Heights	410-693-4745		
MICHIGAN	Grandville	616-261-0425		
	Madison Heights	248-597-5000		
MINNESOTA	Eden Prairie	952-884-9191		
	Eden Prairie	612-331-3770		
	Eden Prairie	612-206-0551		
MISSOURI	St Louis	314-997-9100		

DeWALT Locations		Field Service	DEWALT Tool Service	Anchor Distribution Ctr.
NEVADA	Las Vegas	702-889-6025		
	Las Vegas	702-296-4990		
NEW JERSEY	Elmwood Park	201-475-3524		
NEW YORK	Farmingdale	631-952-2008		
	Woodside	718-335-1042		
NORTH CAROLINA	Charlotte	704-392-0245		
	Charlotte	704-375-5012		
	Greensboro	336-852-1300		
	Raleigh	919-878-0357		
OHIO	Columbus	614-895-3112		
	Maumee	419-297-5348		
	Parma	440-842-9100		
OKLAHOMA	Oklahoma City	405-634-8403		
	Tulsa	918-249-8641		
OREGON	Portland	503-255-6556		
	Portland	503-702-9767		
PENNSYLVANIA	Philadelphia	215-271-5500		
	Philadelphia	267-207-0098		
	Pittsburgh	412-642-0204		
	Pittsburgh	412-721-9005		
	York	717-755-3441		
	York	717-368-6472		
SOUTH CAROLINA	Greenville	864-213-5903		
	Greenville	843-758-8194		
TENNESSEE	Nashville	615-242-1633		
	Nashville	615-248-2667		
	Nashville	214-458-7401		
TEXAS	Carrollton	972-446-2996		
	Carrollton	972-506-9258		
	Carrollton	469-647-1551		
	Fort Worth	817-831-3828		
	Houston	713-466-1194		
	Houston	281-731-2865		
	San Antonio	210-732-1221		
	San Antonio	415-260-4928		
UTAH	Salt Lake City	801-486-5828		
	Salt Lake City	801-466-9428		
	Salt Lake City	801-808-3843		
VIRGINIA	Virginia Beach	757-363-0091		
WASHINGTON	Kent	844-483-4232		
	Seattle	206-763-2010		
	Seattle	713-446-5003		
	Spokane	509-535-9252		
WISCONSIN	West Milwaukee	414-645-4285		
	West Milwaukee	414-645-8821		
	West Milwaukee	414-217-0169		

DeWALT, ELCO, & POWERS Anchors and Fasteners Inquiries: 800-524-3244

DeWALT, ELCO, & POWERS Anchors and Fasteners Technical Questions: email: [engineering@powers.com](mailto:engineering@powers.com)

# 1-800-4 DEWALT®

## www.DEWALT.com