

GENERAL INFORMATION

PE1000+®

Epoxy Injection Adhesive Anchoring System

PRODUCT DESCRIPTION

The PE1000+ is a two-component, high strength adhesive anchoring system. The system includes injection adhesive in plastic cartridges, mixing nozzles, dispensing tools and hole cleaning equipment. The PE1000+ is designed for bonding threaded rod and reinforcing bar hardware into drilled holes in concrete and solid masonry base materials.

GENERAL APPLICATIONS AND USES

- Bonding threaded rod and reinforcing bar into hardened concrete and grouted masonry units
- Evaluated for use in dry and water-saturated concrete (including water-filled holes)
- Cracked and uncracked concrete
- Seismic and wind loading
- Hammer-drill and diamond core drilled hole
- Oversized hammer-drilled holes in concrete, for short term loading only (contact DEWALT for details)
- Can be installed in a wide range of base material temperatures

FEATURES AND BENEFITS

- + Designed for use with threaded rod and reinforcing bar hardware elements
- + Consistent performance in low and high strength concrete (2,500 to 8,500 psi)
- + Evaluated and recognized for freeze/thaw performance
- + Evaluated and recognized for long term and short term loading (see performance tables for applicable temperature ranges)
- + Evaluated and recognized for variable embedments (see installation specifications)
- + Cartridge design allows for multiple uses using extra mixing nozzles
- + Mixing nozzles proportion adhesive and provide simple delivery method into drilled holes
- + Easy dispensing reduces applicator fatigue

APPROVALS AND LISTINGS

- International Code Council, Evaluation Service (ICC-ES) ESR-2583
- Code compliant with the 2018 IBC/IRC, 2015 IBC/IRC, 2012 IBC/IRC, and 2009 IBC/IRC
- Tested in accordance with ACI 355.4 and AC308 for use in structural concrete according to (Strength Design) ACI 318-14 Chapter 17 and ACI 318-11/08 Appendix D.
- Evaluated and qualified by an accredited independent testing laboratory for recognition in cracked and uncracked concrete including seismic and wind loading
- Compliant with NSF/ANSI Standard 61 for drinking water system components – health effects; minimum requirements for materials in contact with potable water and water treatment
- Conforms to requirements of ASTM C 881 and AASHTO M235, Types I, II, IV and V, Grade 3, Classes B & C (also meets type III except for elongation)
- Department of Transportation listings – see www.DEWALT.com or contact transportation agency

GUIDE SPECIFICATIONS

CSI Divisions: 03 16 00 - Concrete Anchors, 04 05 19.16 - Masonry Anchors and 05 05 19 - Post-Installed Concrete Anchors. Adhesive anchoring system shall be PE1000+ as supplied by DEWALT, Towson, MD. Anchors shall be installed in accordance with published instructions and requirements of the Authority Having Jurisdiction.

SECTION CONTENTS

General Information..... 1
 Reference Data (ASD)..... 2
 Strength Design (SD)..... 6
 Installation Instructions (Solid Base Materials)..... 16
 Reference Tables For Installation..... 18
 Ordering Information..... 19



PACKAGING

Dual (side-by-side) Cartridge

- 13 fl. oz. (385 ml), 3:1 mix ratio
- 19.5 fl. oz. (585ml), 3:1 mix ratio

STORAGE LIFE & CONDITIONS

Two years in a dry, dark environment with temperature ranging from 41°F to 95°F (5°C to 35°C)

ANCHOR SIZE RANGE (TYPICAL)

- 3/8" to 1-1/4" diameter threaded rod
- No. 3 to No. 10 reinforcing bar (rebar)

SUITABLE BASE MATERIALS

- Normal-weight concrete
- Lightweight concrete
- Grouted concrete masonry

PERMISSIBLE INSTALLATION CONDITIONS (ADHESIVE)

- Dry concrete
- Water-saturated concrete (wet)
- Water-filled holes (flooded)



REFERENCE DATA (ASD)

Installation Table for PE1000+ (Solid Concrete Base Materials)

Dimension/Property	Notation	Units	Nominal Anchor Size									
			3/8"	1/2"	-	5/8"	3/4"	7/8"	1"	-	1-1/4"	-
Threaded Rod	-	-	#3	-	#4	#5	#6	#7	#8	#9	-	#10
Reinforcing Bar	-	-	#3	-	#4	#5	#6	#7	#8	#9	-	#10
Nominal anchor diameter	d	in. (mm)	0.375 (9.5)	0.500 (12.7)	0.625 (15.9)	0.750 (19.1)	0.875 (22.2)	1.000 (25.4)	1.125 (28.6)	1.250 (31.8)	1.250 (31.8)	1.250 (31.8)
Carbide drill bit nominal size	d _o [d _{bit}]	in.	7/16 ANSI	9/16 ANSI	5/8 ANSI	11/16 or 3/4 ANSI	7/8 ANSI	1 ANSI	1-1/8 ANSI	1-3/8 ANSI	1-3/8 ANSI	1-1/2 ANSI
Diamond core bit nominal size	d _o [d _{bit}]	in.	-	5/8	3/4	7/8	1	1-1/8	-	-	-	-
Minimum nominal embedment	h _{nom}	in. (mm)	2-3/8 (61)	2-3/4 (70)	3-1/8 (79)	3-1/2 (89)	3-1/2 (89)	4 (102)	4-1/2 (114)	5 (127)	5 (127)	5 (127)
Minimum spacing distance	s _{min}	in. (mm)	1-7/8 (48)	2-1/2 (62)	3-1/8 (80)	3-3/4 (95)	4-3/8 (111)	5 (127)	5-5/8 (143)	6-1/4 (159)	6-1/4 (159)	6-1/4 (159)
Minimum edge distance	c _{min}	in (mm)	5d where d is nominal outside diameter of the anchor									
Minimum edge distance, reduced ⁴	c _{min,red}	in (mm)	1-3/4 (44)	1-3/4 (44)	1-3/4 (44)	1-3/4 (44)	1-3/4 (44)	1-3/4 (44)	1-3/4 (44)	2-3/4 (70)	2-3/4 (70)	2-3/4 (70)
Max. Torque ¹	T _{max}	ft-lbs	15	33	60	105	125	165	200	280	280	280
Max. Torque ^{1,2} (A36/Grade 36 rod)	T _{max}	ft-lbs	10	25	50	90	125	165	N/A	280	280	N/A
Max. Torque ^{1,3} (Class 1 SS rod)	T _{max}	ft-lbs	5	20	40	60	100	165	N/A	280	280	N/A
Effective cross sectional area of threaded rod	A _{se}	in. ² (mm ²)	0.078 (50)	0.142 (92)	0.226 (146)	0.335 (216)	0.462 (298)	0.606 (391)	-	0.969 (625)	-	-
Effective cross sectional area of reinforcing bar	A _{se}	in. ² (mm ²)	0.110 (71)	0.200 (129)	0.310 (200)	0.440 (284)	0.600 (387)	0.790 (510)	1.000 (645)	-	-	1.270 (819)

1. Torque may not be applied until the full cure time of the adhesive has been achieved.
2. Applies to ASTM A36/F 1554 Grade 36 carbon steel threaded rods only.
3. These torque values apply to ASTM A193 Grade B8/B8m (Class 1) stainless steel threaded rods only.
4. For installations at the reduced minimum edge, c_{min,red}, the max torque, T_{max}, must be multiplied by a reduction factor of 0.45.

Detail of Steel Hardware Elements used with Injection Adhesive System

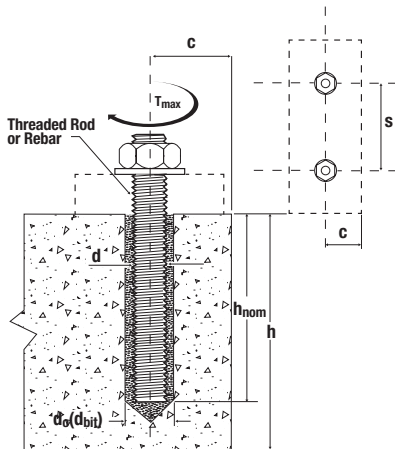

Steel Description (General)	Steel Specification (ASTM)	Nominal Anchor Size (inch)	Minimum Yield Strength f _y (ksi)	Minimum Ultimate Strength f _u (ksi)
Carbon Rod	A 36 or F 1554, Grade 36	3/8 through 1-1/4	36.0	58.0
	F 1554 Grade 55		55.0	75.0
	A 193, Grade B7 or F 1554, Grade 105		105.0	125.0
Stainless Rod (Alloy 304 / 316)	F 593 Condition CW	3/8 through 5/8	65.0	100.0
		3/4 through 1-1/4	45.0	85.0
Grade 60 Reinforcing Bar	A 615, or A 767, A 996	3/8 through 1-1/4 (#3 through #10)	60.0	90.0
Grade 40 Reinforcing Bar	A 615	3/8 through 3/4 (#3 through #6)	40.0	60.0

Nomenclature

- d = Diameter of anchor
- d_{bit} = Diameter of drilled hole
- h = Base material thickness
The minimum value of h should be 1.5h_{nom} or 3", whichever is greater.
- h_{nom} = Minimum embedment depth



ADHESIVES

PE1000+®
Epoxy Injection Adhesive Anchoring System

Allowable Load Capacities for PE1000+ Installed into Uncracked Normal-Weight Concrete with Threaded Rod and Reinforcing Bar (Based on Bond Strength/Concrete Capacity)^{1,2,3,4,5,6}

Nominal Rod/Rebar Size (in. or #)	Minimum Embedment Depth (in.)	Minimum Concrete Compressive Strength, (f'c)			
		3,000 psi	4,000 psi	5,000 psi	6,000 psi
		Tension (lbs)			
3/8 or #3	2-3/8	1,195	1,235	1,270	1,300
	3-1/2	1,760	1,825	1,875	1,915
	4-1/2	2,265	2,345	2,410	2,460
1/2 or #4	2-3/4	1,770	1,835	1,885	1,925
	4-3/8	2,820	2,915	2,995	3,065
	6	3,865	4,000	4,110	4,200
5/8 or #5	3-1/8	2,420	2,505	2,575	2,630
	5-1/4	4,145	4,290	4,405	4,505
	7-1/2	5,970	6,180	6,345	6,485
3/4 or #6	3-1/2	2,870	2,970	3,050	3,120
	6-1/4	5,715	5,915	6,075	6,210
	9	8,560	8,860	9,100	9,300
7/8 or #7	3-1/2	2,870	2,970	3,050	3,120
	7	7,285	7,540	7,745	7,915
	10-1/2	11,700	12,110	12,440	12,715
1 or #8	4	3,505	3,630	3,725	3,810
	8	9,570	9,905	10,175	10,400
	12	15,635	16,185	16,625	16,990
1-1/8 or #9	4-1/2	4,185	4,330	4,445	4,545
	9	12,025	12,445	12,785	13,065
	13-1/2	19,865	20,560	21,120	21,585
1-1/4 or #10	5	4,900	5,070	5,210	5,325
	10	15,030	15,560	15,980	16,335
	15	25,165	26,045	26,755	27,345

1. Allowable load capacities listed are calculated using an applied safety factor of 4.0. Consideration of safety factors of 10 or higher may be necessary depending on the application, such as life safety or overhead.
2. Linear interpolation may be used to determine allowable loads for intermediate embedments and compressive strengths.
3. The tabulated load values are applicable to single anchors installed at critical edge and spacing distances and at the minimum member thickness.
4. The tabulated load values are for applicable for dry concrete. Holes must be drilled with a hammer drill and an ANSI carbide drill bit. Installations into saturated (wet) concrete and in water-filled holes require a reduction in capacity for tabulated values of 30 percent and 50 percent, respectively. Contact DEWALT for more information concerning these installation conditions.
5. Adhesives experience reductions in capacity at elevated temperatures. See the in-service temperature chart for allowable load capacity reduction factors.
6. Allowable bond strength/concrete capacity must be checked against allowable steel strength in tension to determine the controlling allowable load. Allowable shear capacity is controlled by steel strength for the given conditions.



Allowable Load Capacities for Threaded Rod and Reinforcing Bar (Based on Steel Strength)^{1,2,3,4,5}

Nominal Rod Diameter or Rebar Size (in. or #)	Steel Elements - Threaded Rod and Reinforcing Bar																	
	A36 or F1554, Grade 36		A36 or F1554, Grade 55		A 193, Grade B7 or F1554, Grade 105		F 593, CW (SS)		ASTM A615 Grade 40 Rebar		ASTM A615 Grade 60 Rebar		ASTM A706 Grade 60 Rebar		ASTM A615 Grade 75 Rebar		ASTM A706 Grade 80 Rebar	
	Tension lbs. (kN)	Shear lbs. (kN)	Tension lbs. (kN)	Shear lbs. (kN)	Tension lbs. (kN)	Shear lbs. (kN)	Tension lbs. (kN)	Shear lbs. (kN)	Tension lbs. (kN)	Shear lbs. (kN)	Tension lbs. (kN)	Shear lbs. (kN)	Tension lbs. (kN)	Shear lbs. (kN)	Tension lbs. (kN)	Shear lbs. (kN)	Tension lbs. (kN)	Shear lbs. (kN)
3/8 or #3	2,115 (9.4)	1,090 (4.8)	2,735 (12.2)	1,410 (6.3)	4,555 (20.3)	2,345 (10.4)	3,645 (16.2)	1,880 (8.4)	2,210 (9.8)	1,125 (5.0)	2,650 (11.8)	1,690 (7.5)	2,650 (11.8)	1,500 (6.7)	2,650 (11.8)	1,875 (8.3)	2,650 (11.8)	1,875 (8.3)
1/2 or #4	3,760 (16.7)	1,935 (8.6)	4,860 (21.6)	2,505 (11.1)	8,100 (36.0)	4,170 (18.5)	6,480 (28.8)	3,340 (14.9)	3,925 (17.5)	2,005 (8.9)	4,710 (21.0)	3,005 (13.4)	4,710 (21.0)	2,670 (11.9)	4,710 (21.0)	3,335 (14.8)	4,710 (21.0)	3,335 (14.8)
5/8 or #5	5,870 (26.1)	3,025 (13.5)	7,595 (33.8)	3,910 (17.4)	12,655 (56.3)	6,520 (29.0)	10,125 (45.0)	5,215 (23.2)	6,135 (27.3)	3,130 (13.9)	7,365 (32.8)	4,695 (20.9)	7,365 (32.8)	4,170 (18.5)	7,365 (32.8)	5,215 (23.2)	7,365 (32.8)	5,215 (23.2)
3/4 or #6	8,455 (37.6)	4,355 (19.4)	10,935 (48.6)	5,635 (25.1)	18,225 (81.1)	9,390 (41.8)	12,390 (55.1)	6,385 (28.4)	8,835 (39.3)	4,505 (20.0)	10,605 (47.2)	6,760 (30.1)	10,605 (47.2)	6,010 (26.7)	10,605 (47.2)	7,510 (33.4)	10,605 (47.2)	7,510 (33.4)
7/8 or #7	11,510 (51.2)	5,930 (26.4)	14,885 (66.2)	7,665 (34.1)	24,805 (110.3)	12,780 (56.8)	16,865 (75.0)	8,690 (38.7)	-	-	14,430 (64.2)	9,200 (40.9)	14,430 (64.2)	8,180 (36.4)	14,430 (64.2)	10,220 (45.5)	14,430 (64.2)	10,220 (45.5)
1 or #8	15,035 (66.9)	7,745 (34.5)	19,440 (86.5)	10,015 (44.5)	32,400 (144.1)	16,690 (74.2)	22,030 (98.0)	11,350 (50.5)	-	-	18,850 (83.8)	12,015 (53.4)	18,850 (83.8)	10,680 (47.5)	18,850 (83.8)	13,350 (59.4)	18,850 (83.8)	13,350 (59.4)
#9	-	-	-	-	-	-	-	-	-	-	23,985 (106.7)	15,290 (68.0)	23,985 (106.7)	13,590 (60.5)	23,985 (106.7)	16,990 (75.6)	23,985 (106.7)	16,990 (75.6)
1-1/4	23,490 (104.5)	12,100 (53.8)	30,375 (135.1)	15,645 (69.6)	50,620 (225.2)	26,080 (116.0)	34,425 (153.1)	17,735 (78.9)	-	-	-	-	-	-	-	-	-	-
#10	-	-	-	-	-	-	-	-	-	-	30,405 (135.2)	19,380 (86.2)	30,405 (135.2)	17,230 (76.6)	30,405 (135.2)	21,535 (95.8)	30,405 (135.2)	21,535 (95.8)

1. AISC defined steel strength (ASD) for threaded rod: Tensile = $0.33 \cdot F_u \cdot A_{nom}$, Shear = $0.17 \cdot F_u \cdot A_{nom}$
2. For reinforcing bars: The allowable steel tensile strength is based on 20 ksi for Grade 40 and 24 ksi for Grade 60 and higher, applied to the cross sectional area of the bar; allowable steel shear strength = $0.17 \cdot F_u \cdot A_{nom}$
3. Allowable load capacities are calculated for the steel element type. Consideration of applying additional safety factors may be necessary depending on the application, such as life safety or overhead.
4. Allowable steel strength in tension must be checked against allowable bond strength/concrete capacity in tension to determine the controlling allowable load.
5. The tabulated load values are applicable to single anchors installed at critical edge and spacing distances and where the minimum member thickness is the greater of $[t_{nom} + 1-1/4"]$ and $[t_{nom} + 2d_{bar}]$

In-Service Temperature Chart for Allowable Load Capacities

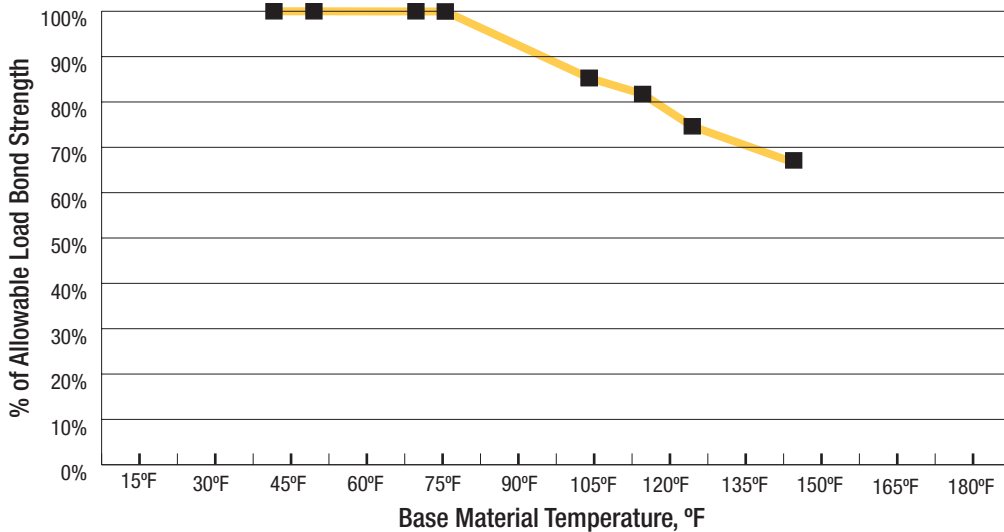



Ultimate Load Capacities for Threaded Rod Installed with PE1000+ into the Block Face of Grout-Filled Concrete Masonry Walls^{1,2,4}

Nominal Rod Diameter d. in.	Drill Diameter d _{bit} in.	Minimum Embedment Depth in. (mm)	Minimum Edge Distance in. (mm)	Minimum End Distance in. (mm)	Ultimate Load ³		Allowable Load	
					Tension lbs. (kN)	Shear lbs. (kN)	Tension lbs. (kN)	Shear lbs. (kN)
3/8	7/16	3 (76.2)	2-1/2 (63.5)	2-1/2 (63.5)	3,350 (14.9)	2,100 (9.3)	670 (2.9)	420 (1.9)
1/2	9/16	4 (101.6)	3 (76.2)	3 (76.2)	4,575 (20.3)	2,550 (11.3)	915 (4.1)	510 (2.3)
5/8	11/16	5 (127.0)	3-3/4 (95.3)	4 (101.6)	6,900 (30.7)	5,275 (23.5)	1,380 (6.1)	1,055 (4.7)

1. Tabulated load values are for anchors installed in minimum 8" wide, minimum Grade N, Type II, lightweight, medium-weight or normal-weight concrete masonry units conforming to ASTM C 90 that have reached a designated minimum compressive strength at the time of installation ($f'_m \geq 1,500$ psi). Mortar must be type N, S or M.
2. Anchor installations are limited to one per masonry cell. Shear loads may be applied in any direction.
3. The values listed are ultimate load capacities which should be reduced by a minimum safety factor of 5.0 or greater to determine the allowable working load. Consideration of safety factors of 10 or higher may be necessary depending on the application, such as life safety.
4. The tabulated values must be adjusted for increased in-service base material temperatures in accordance with the In-Service Temperature chart, as applicable.

Load Capacities for Threaded Rod Installed with PE1000+ in the Top of Grout-Filled Concrete Masonry Walls^{1,2,4}

Nominal Rod Diameter d. in.	Drill Diameter d _{bit} in.	Minimum Embedment Depth in. (mm)	Minimum Edge Distance in. (mm)	Minimum End Distance in. (mm)	Ultimate Load ³		Allowable Load	
					Tension lbs. (kN)	Shear lbs. (kN)	Tension lbs. (kN)	Shear lbs. (kN)
1/2	9/16	6 (152.4)	1-3/4 (44.5)	3 (76.2)	5,950 (26.4)	1,450 (6.5)	1,190 (5.3)	290 (1.3)
5/8	11/16	8 (203.2)	1-3/4 (44.5)	4 (101.6)	9,450 (42.0)	1,700 (7.5)	1,890 (8.4)	340 (1.4)

1. Tabulated load values are for anchors installed in a minimum Grade N, Type II, lightweight, medium-weight or normal-weight masonry units conforming to ASTM C 90 that have reached a designated minimum compressive strength at the time of installation ($f'_m \geq 1,500$ psi). Mortar must be type N, S or M.
2. Anchor installations are limited to one per masonry cell. Shear loads may be applied in any direction.
3. The values listed are ultimate load capacities which should be reduced by a minimum safety factor of 5.0 or greater to determine the allowable working load. Consideration of safety factors of 10 or higher may be necessary depending on the application, such as life safety.
4. The tabulated values must be adjusted for increased in-service base material temperatures in accordance with the In-Service Temperature chart, as applicable.

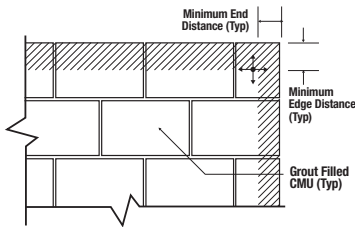

Face Shell
Permissible Anchor Locations
(Un-hatched Area / Through Face Shell)

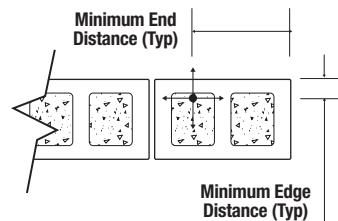

Top of Wall

STRENGTH DESIGN (SD)

Installation Specifications for Threaded Rod and Reinforcing Bar¹

CODE LISTED
ICC-ES ESR-2583



Dimension/Property	Notation	Units	Nominal Anchor Size									
			3/8"	1/2"	-	5/8"	3/4"	7/8"	1"	-	1-1/4"	-
Threaded Rod	-	-	3/8"	1/2"	-	5/8"	3/4"	7/8"	1"	-	1-1/4"	-
Reinforcing Bar	-	-	#3	-	#4	#5	#6	#7	#8	#9	-	#10
Nominal anchor diameter	d	in. (mm)	0.375 (9.5)	0.500 (12.7)		0.625 (15.9)	0.750 (19.1)	0.875 (22.2)	1.000 (25.4)	1.125 (28.6)	1.250 (31.8)	1.250 (31.8)
Carbide drill bit nominal size	d _o [d _{bit}]	in.	7/16 ANSI	9/16 ANSI	5/8 ANSI	11/16 or 3/4 ANSI	7/8 ANSI	1 ANSI	1-1/8 ANSI	1-3/8 ANSI	1-3/8 ANSI	1-1/2 ANSI
Diamond core bit nominal size	d _o [d _{bit}]	in.	-	5/8		3/4	7/8	1	1-1/8	-	-	-
Minimum embedment	h _{ef,min}	in. (mm)	2-3/8 (61)	2-3/4 (70)		3-1/8 (79)	3-1/2 (89)	3-1/2 (89)	4 (102)	4-1/2 (114)	5 (127)	5 (127)
Maximum embedment ⁴	h _{ef,max}	in. (mm)	4-1/2 (114)	10 (254)		12-1/2 (318)	15 (381)	17-1/2 (445)	20 (508)	22-1/2 (572)	25 (635)	25 (635)
Minimum concrete member thickness	h _{min}	in. (mm)	h _{ef} + 1-1/4 (h _{ef} + 30)			h _{ef} + 2d _o						
Minimum spacing distance	s _{min}	in. (mm)	1-7/8 (48)	2-1/2 (62)		3-1/8 (80)	3-3/4 (95)	4-3/8 (111)	5 (127)	5-5/8 (143)	6-1/4 (159)	6-1/4 (159)
Minimum edge distance	c _{min}	in (mm)	5d where d is nominal outside diameter of the anchor									
Minimum edge distance, reduced ⁵	c _{min,red}	in (mm)	1-3/4 (44)	1-3/4 (44)	1-3/4 (44)	1-3/4 (44)	1-3/4 (44)	1-3/4 (44)	1-3/4 (44)	2-3/4 (70)	2-3/4 (70)	2-3/4 (70)
Max. Torque ²	T _{max}	ft-lbs	15	33		60	105	125	165	200	280	280
Max. Torque ^{2,3} (A36/Grade 36 rod)	T _{max}	ft-lbs	10	25		50	90	125	165	N/A	280	N/A
Max. Torque ^{2,4} (Class 1 SS rod)	T _{max}	ft-lbs	5	20		40	60	100	165	N/A	280	N/A
Effective cross sectional area of threaded rod	A _{se}	in. ² (mm ²)	0.078 (50)	0.142 (92)		0.226 (146)	0.335 (216)	0.462 (298)	0.606 (391)	-	0.969 (625)	-
Effective cross sectional area of reinforcing bar	A _{se}	in. ² (mm ²)	0.110 (71)	0.200 (129)		0.310 (200)	0.440 (284)	0.600 (387)	0.790 (510)	1.000 (645)	-	1.270 (819)

For SI: 1 inch = 25.4 mm, 1 ft-lbf = 1.356 N-m. For pound-inch units: 1 mm = 0.03937 inch, 1 N-m = 0.7375 ft-lbf.

- For use with the design provisions of ACI 318-14 Ch.17 or ACI 318-11 Appendix D as applicable, ICC-ES AC308 Section 4.2 and ESR-2583
- Torque may not be applied to the anchors until the full cure time of the adhesive has been achieved
- These torque values apply to ASTM A36/F 1554 Grade 36 carbon steel threaded rods only.
- These torque values apply to ASTM A197 Grade B8/B8M (Class 1) stainless steel threaded rods only
- For installation at the reduced minimum edge distance, c_{min,red}, the max torque, T_{max} must be multiplied by a reduction factor of 0.45.
- The maximum embedment is limited to 12 diameters for the horizontal and upwardly inclined installations and for installations in water-filled (flooded) holes with a carbide drill bit.

Detail of Steel Hardware Elements used with Injection Adhesive System

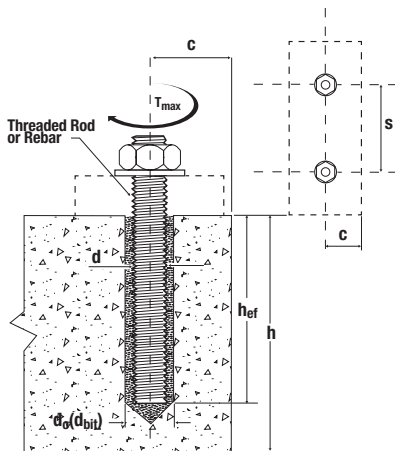

Steel Description (General)	Steel Specification (ASTM)	Nominal Anchor Size (inch)	Minimum Yield Strength f _y (ksi)	Minimum Ultimate Strength f _u (ksi)
Carbon Rod	A 36 or F 1554, Grade 36	3/8 through 1-1/4	36.0	58.0
	F 1554 Grade 55		55.0	75.0
	A 193, Grade B7 or F 1554, Grade 105		105.0	125.0
Stainless Rod (Alloy 304 / 316)	F 593 Condition CW	3/8 through 5/8	65.0	100.0
		3/4 through 1-1/4	45.0	85.0
Grade 60 Reinforcing Bar	A 615, or A 767, A 996	3/8 through 1-1/4 (#3 through #10)	60.0	90.0
	A 706		60.0	80.0
Grade 40 Reinforcing Bar	A 615	3/8 through 3/4 (#3 through #6)	40.0	60.0

**Steel Tension and Shear Design for Threaded Rod in Normal Weight Concrete
(For use with load combinations taken from ACI 318-14 Section 5.3)**

CODE LISTED
ICC-ES ESR-2583



ADHESIVES

PE1000+
Epoxy Injection Adhesive Anchoring System

Design Information		Symbol	Units	Nominal Rod Diameter* (inch)						
				3/8	1/2	5/8	3/4	7/8	1	1-1/4
Threaded rod nominal outside diameter		d	inch (mm)	0.375 (9.5)	0.500 (12.7)	0.625 (15.9)	0.750 (19.1)	0.875 (22.2)	1.000 (25.4)	1.250 (31.8)
Threaded rod effective cross-sectional area		A _{se}	inch ² (mm ²)	0.0775 (50)	0.1419 (92)	0.2260 (146)	0.3345 (216)	0.4617 (298)	0.6057 (391)	0.9691 (625)
ASTM A 36 and ASTM F 1554 Grade 36	Nominal strength as governed by steel strength (for a single anchor)	N _{sa}	lbf (kN)	4,495 (20.0)	8,230 (36.6)	13,110 (58.3)	19,400 (86.3)	26,780 (119.1)	35,130 (156.3)	56,210 (250.0)
		V _{sa}	lbf (kN)	2,695 (12.0)	4,940 (22.0)	7,860 (35.0)	11,640 (51.8)	16,070 (71.4)	21,080 (93.8)	33,725 (150.0)
	Reduction factor for seismic shear	α _{v,seis}	-	0.80	0.80	0.80	0.80	0.80	0.80	0.80
	Strength reduction factor for tension ²	φ	-	0.75						
	Strength reduction factor for shear ²	φ	-	0.65						
ASTM F 1554 Grade 55	Nominal strength as governed by steel strength (for a single anchor)	N _{sa}	lbf (kN)	5,810 (25.9)	10,640 (47.3)	16,950 (75.4)	25,085 (111.6)	34,625 (154.0)	45,425 (202.0)	72,680 (323.3)
		V _{sa}	lbf (kN)	3,485 (15.5)	6,385 (28.4)	10,170 (45.2)	15,050 (67.0)	20,775 (92.4)	27,255 (121.2)	43,610 (194.0)
	Reduction factor for seismic shear	α _{v,seis}	-	0.80	0.80	0.80	0.80	0.80	0.80	0.80
	Strength reduction factor for tension ²	φ	-	0.75						
	Strength reduction factor for shear ²	φ	-	0.65						
ASTM A 193 Grade B7 and ASTM F 1554 Grade 105	Nominal strength as governed by steel strength (for a single anchor)	N _{sa}	lbf (kN)	9,685 (43.1)	17,735 (78.9)	28,250 (125.7)	41,810 (186.0)	57,710 (256.7)	75,710 (336.8)	121,135 (538.8)
		V _{sa}	lbf (kN)	5,815 (25.9)	10,640 (7.3)	16,950 (75.4)	25,085 (111.6)	34,625 (154.0)	45,425 (202.1)	72,680 (323.3)
	Reduction factor for seismic shear	α _{v,seis}	-	0.80	0.80	0.80	0.80	0.80	0.80	0.80
	Strength reduction factor for tension ²	φ	-	0.75						
	Strength reduction factor for shear ²	φ	-	0.65						
ASTM F 593 CW Stainless (Types 304 and 316)	Nominal strength as governed by steel strength (for a single anchor)	N _{sa}	lbf (kN)	7,750 (34.5)	14,190 (63.1)	22,600 (100.5)	28,430 (126.5)	39,245 (174.6)	51,485 (229.0)	82,370 (366.4)
		V _{sa}	lbf (kN)	4,650 (20.7)	8,515 (37.9)	13,560 (60.3)	17,060 (75.9)	23,545 (104.7)	30,890 (137.4)	49,425 (219.8)
	Reduction factor for seismic shear	α _{v,seis}	-	0.70	0.70	0.80	0.80	0.80	0.80	0.80
	Strength reduction factor for tension ³	φ	-	0.65						
	Strength reduction factor for shear ³	φ	-	0.60						
ASTM A 193 Grade B8/B8M, Class 1 Stainless (Types 304 and 316)	Nominal strength as governed by steel strength (for a single anchor) ⁴	N _{sa}	lbf (kN)	4,420 (19.7)	8,090 (36.0)	12,880 (57.3)	19,065 (84.8)	26,315 (117.1)	34,525 (153.6)	55,240 (245.7)
		V _{sa}	lbf (kN)	2,650 (11.8)	4,855 (21.6)	7,730 (34.4)	11,440 (50.9)	15,790 (70.2)	20,715 (92.1)	33,145 (147.4)
	Reduction factor for seismic shear	α _{v,seis}	-	0.70	0.70	0.80	0.80	0.80	0.80	0.80
	Strength reduction factor for tension ²	φ	-	0.75						
	Strength reduction factor for shear ²	φ	-	0.65						
ASTM A 193 Grade B8/ B8M2, Class 2B Stainless (Types 304 and 316)	Nominal strength as governed by steel strength (for a single anchor)	N _{sa}	lbf (kN)	7,365 (32.8)	13,480 (60.0)	21,470 (95.5)	31,775 (141.3)	43,860 (195.1)	57,545 (256.0)	92,065 (409.5)
		V _{sa}	lbf (kN)	4,420 (19.7)	8,085 (36.0)	12,880 (57.3)	19,065 (84.8)	26,315 (117.1)	34,525 (153.6)	55,240 (245.7)
	Reduction factor for seismic shear	α _{v,seis}	-	0.70	0.70	0.80	0.80	0.80	0.80	0.80
	Strength reduction factor for tension ²	φ	-	0.75						
	Strength reduction factor for shear ²	φ	-	0.65						

For St: 1 inch = 25.4 mm, 1 lbf = 4.448 N. For pound-inch units: 1 mm = 0.03937 inches, 1 N = 0.2248 lbf.

- Values provided for steel element material types are based on minimum specified strengths and calculated in accordance with ACI 318-14 Eq. 17.4.1.2 and Eq. 17.5.1.2b or ACI 318-11 Eq. (D-2) and Eq. (D-29), as applicable, except where noted. Nuts and washers must be appropriate for the rod. Nuts must have specified proof load stresses equal to or greater than the minimum tensile strength of the specified threaded rod.
- The tabulated value of φ applies when the load combinations of Section 1605.2 of the IBC, ACI 318-14 5.3 or ACI 318-11 9.2, as applicable, are used in accordance with ACI 318-14 17.3.3 or ACI 318-11 D.4.3, as applicable. If the load combinations of ACI 318-11 Appendix C are used, the appropriate value of φ must be determined in accordance with ACI 318 D.4.4. Values correspond to ductile steel elements.
- The tabulated value of φ applies when the load combinations of Section 1605.2 of the IBC, ACI 318-14 5.3 or ACI 318-11 9.2, as applicable, are used in accordance with ACI 318-14 17.3.3 or ACI 318-11 D.4.3, as applicable. If the load combinations of ACI 318-11 Appendix C are used, the appropriate value of φ must be determined in accordance with ACI 318 D.4.4. Values correspond to brittle steel elements.
- In accordance with ACI 318-14 17.4.1.2 and 17.5.1.2 or ACI 318-11 D.5.1.2 and D.6.1.2, as applicable, the calculated values for nominal tension and shear strength for ASTM A193 Grade B8/B8M Class 1 stainless steel threaded rods are based on limiting the specified tensile strength of the anchor steel to 1.9fy or 57,000 psi (393 MPa).

**Steel Tension and Shear Design for Reinforcing Bars in Normal Weight Concrete
(For use with load combinations taken from ACI 318-14 Section 5.3)**

CODE LISTED
ICC-ES ESR-2583



Design Information	Symbol	Units	Nominal Reinforcing Bar Size (Rebar)								
			No. 3	No. 4	No. 5	No. 6	No. 7	No. 8	No. 9	No. 10	
Rebar nominal outside diameter	d	inch (mm)	0.375 (9.5)	0.500 (12.7)	0.625 (15.9)	0.750 (19.1)	0.875 (22.2)	1.000 (25.4)	1.125 (28.7)	1.250 (32.3)	
Rebar effective cross-sectional area	A _{se}	inch ² (mm ²)	0.110 (71.0)	0.200 (129.0)	0.310 (200.0)	0.440 (283.9)	0.600 (387.1)	0.790 (509.7)	1.000 (645.2)	1.270 (819.4)	
ASTM A 615 Grade 75	Nominal strength as governed by steel strength (for a single anchor)	N _{sa}	lbf (kN)	11,000 (48.9)	20,000 (89.0)	31,000 (137.9)	44,000 (195.7)	60,000 (266.9)	79,000 (351.4)	100,000 (444.8)	127,000 (564.9)
		V _{sa}	lbf (kN)	6,600 (29.4)	12,000 (53.4)	18,600 (82.7)	26,400 (117.4)	36,000 (160.1)	47,400 (210.8)	60,000 (266.9)	76,200 (338.9)
	Reduction factor for seismic shear	α _{v,seis}	-	0.70	0.70	0.80	0.80	0.80	0.80	0.80	0.80
	Strength reduction factor for tension ²	φ	-	0.65							
	Strength reduction factor for shear ³	φ	-	0.60							
ASTM A 615 Grade 60	Nominal strength as governed by steel strength (for a single anchor)	N _{sa}	lbf (kN)	9,900 (44.0)	18,000 (80.1)	27,900 (124.1)	39,600 (176.1)	54,000 (240.2)	71,100 (316.3)	90,000 (400.3)	114,300 (508.4)
		V _{sa}	lbf (kN)	5,940 (26.4)	10,800 (48.0)	16,740 (74.5)	23,760 (105.7)	32,400 (144.1)	42,660 (189.8)	54,000 (240.2)	68,580 (305.0)
	Reduction factor for seismic shear	α _{v,seis}	-	0.70	0.70	0.80	0.80	0.80	0.80	0.80	0.80
	Strength reduction factor for tension ²	φ	-	0.75							
	Strength reduction factor for shear ²	φ	-	0.65							
ASTM A 706 Grade 60	Nominal strength as governed by steel strength (for a single anchor)	N _{sa}	lbf (kN)	8,800 (39.1)	16,000 (71.2)	24,800 (110.3)	35,200 (156.6)	48,000 (213.5)	63,200 (281.1)	80,000 (355.9)	101,600 (452.0)
		V _{sa}	lbf (kN)	5,280 (23.5)	9,600 (42.7)	14,880 (66.2)	21,120 (94.0)	28,800 (128.1)	37,920 (168.7)	48,000 (213.5)	60,960 (271.2)
	Reduction factor for seismic shear	α _{v,seis}	-	0.70	0.70	0.80	0.80	0.80	0.80	0.80	0.80
	Strength reduction factor for tension ²	φ	-	0.75							
	Strength reduction factor for shear ²	φ	-	0.65							
ASTM A 615 Grade 40	Nominal strength as governed by steel strength (for a single anchor)	N _{sa}	lbf (kN)	6,600 (29.4)	12,000 (53.4)	18,600 (82.7)	26,400 (117.4)	In accordance with ASTM A 615, Grade 40 bars are furnished only in sizes No. 3 through No. 6			
		V _{sa}	lbf (kN)	3,960 (17.6)	7,200 (32.0)	11,160 (49.6)	15,840 (70.5)				
	Reduction factor for seismic shear	α _{v,seis}	-	0.70	0.70	0.80	0.80				
	Strength reduction factor for tension ²	φ	-	0.75							
	Strength reduction factor for shear ²	φ	-	0.65							

For SI: 1 inch = 25.4 mm, 1 lbf = 4.448 N. For pound-inch units: 1 mm = 0.03937 inches, 1 N = 0.2248 lbf.

1. Values provided for reinforcing bar material types based on minimum specified strengths and calculated in accordance with ACI 318-14 Eq. 17.4.1.2 and Eq. 17.5.1.2b or ACI 318-11 Eq. (D-2) and Eq. (D-29), as applicable.
2. The tabulated value of φ applies when the load combinations of Section 1605.2 of the IBC, ACI 318-14 5.3 or ACI 318-11 9.2, as applicable, are used in accordance with ACI 318-14 17.3.3 or ACI 318-11 D.4.3, as applicable. If the load combinations of ACI 318-11 Appendix C are used, the appropriate value of φ must be determined in accordance with ACI 318 D.4.4. Values correspond to ductile steel elements. In accordance with ACI 318-14 17.2.3.4.3(a)(vi) or ACI 318-11 D.3.3.4.3(a)6, as applicable, deformed reinforcing bars meeting this specification used as ductile steel elements to resist earthquake effects shall be limited to reinforcing bars satisfying the requirements of ACI 318-14 20.2.2.4 and 20.2.2.5 or ACI 318-11 21.1.5.2 (a) and (b), as applicable.
3. The tabulated value of φ applies when the load combinations of Section 1605.2 of the IBC, ACI 318-14 5.3 or ACI 318-11 9.2, as applicable, are used in accordance with ACI 318-14 17.3.3 or ACI 318-11 D.4.3, as applicable. If the load combinations of ACI 318-11 Appendix C are used, the appropriate value of φ must be determined in accordance with ACI 318 D.4.4. Values correspond to brittle steel elements.

**Concrete Breakout Design Information for Threaded Rod and Reinforcing Bars
(For use with loads combinations taken from ACI 318-14 Section 5.3)¹**

CODE LISTED
ICC-ES ESR-2583



Design Information	Symbol	Units	Nominal Rod Diameter (inch) / Reinforcing Bar Size							
			3/8 or #3	1/2 or #4	5/8 or #5	3/4 or #6	7/8 or #7	1 or #8	#9	1-1/4 or #10
Effectiveness factor for cracked concrete	$k_{c,cr}$	- (SI)	Not Applicable			17 (7.1)				
Effectiveness factor for uncracked concrete	$k_{c,uncr}$	- (SI)	24 (10.0)							
Minimum embedment	$h_{ef,min}$	inch (mm)	2-3/8 (60)	2-3/4 (70)	3-1/8 (79)	3-1/2 (89)	3-1/2 (89)	4 (102)	4-1/2 (114)	5 (127)
Maximum embedment	$h_{ef,max}$	inch (mm)	7-1/2 (191)	10 (254)	12-1/2 (318)	15 (381)	17-1/2 (445)	20 (508)	22-1/2 (572)	25 (635)
Minimum anchor spacing	s_{min}	inch (mm)	1-7/8 (48)	2-1/2 (64)	3-1/8 (79)	3-3/4 (95)	4-3/8 (111)	5 (127)	5-5/8 (143)	6-1/4 (159)
Minimum edge distance ²	c_{min}	inch (mm)	5d where d is nominal outside diameter of the anchor							
Minimum edge distance, reduced ²	$c_{min,red}$	inch (mm)	1-3/4 (45)	1-3/4 (45)	1-3/4 (45)	1-3/4 (45)	1-3/4 (45)	1-3/4 (45)	2-3/4 (70)	2-3/4 (70)
Minimum member thickness	h_{min}	inch (mm)	$h_{ef} + 1-1/4 (h_{ef} + 30)$		$h_{ef} + 2d_o$ where d_o is hole diameter;					
Critical edge distance—splitting (for uncracked concrete only) ³	c_{ac}	inch	$c_{ac} = h_{ef} \cdot \left(\frac{\tau_{k,uncr}}{1160}\right)^{0.4} \cdot [3.1 - 0.7 \frac{h}{h_{ef}}]$							
		(mm)	$c_{ac} = h_{ef} \cdot \left(\frac{\tau_{k,uncr}}{8}\right)^{0.4} \cdot [3.1 - 0.7 \frac{h}{h_{ef}}]$							
Strength reduction factor for tension, concrete failure modes, Condition B ⁴	ϕ	-	0.65							
Strength reduction factor for shear, concrete failure modes, Condition B ⁴	ϕ	-	0.70							

For SI: 1 inch = 25.4 mm, 1 lbf = 4.448 N. For pound-inch units: 1 mm = 0.03937 inch, 1 N = 0.2248 lbf.

- Additional setting information is described in the installation instructions.
- For installation between the minimum edge distance, c_{min} , and the reduced minimum edge distance, $c_{min,red}$, the maximum torque applied must be reduced (multiplied) by a factor of 0.45.
- $\tau_{k,uncr}$ need not be taken as greater than: $\tau_{k,uncr} = k_{uncr} \cdot \sqrt{h_{ef}} \cdot f'_c$ and $\frac{h}{h_{ef}}$ need not be taken as larger than 2.4.
- Condition A requires supplemental reinforcement, while Condition B applies where supplemental reinforcement is not provided or where pryout governs, as set forth in ACI 318-14 17.3.3 or ACI 318-11 D.4.3, as applicable. The tabulated value of ϕ applies when the load combinations of Section 1605.2 of the IBC, ACI 318-14 5.3 or ACI 318-11 9.2, as applicable, are used in accordance with ACI 318-14 17.3.3 or ACI 318-11 D.4.3, as applicable. If the load combinations of ACI 318-11 Appendix C are used, the appropriate value of ϕ must be determined in accordance with ACI 318 D.4.4.

FLOWCHART FOR THE ESTABLISHMENT OF DESIGN BOND STRENGTH

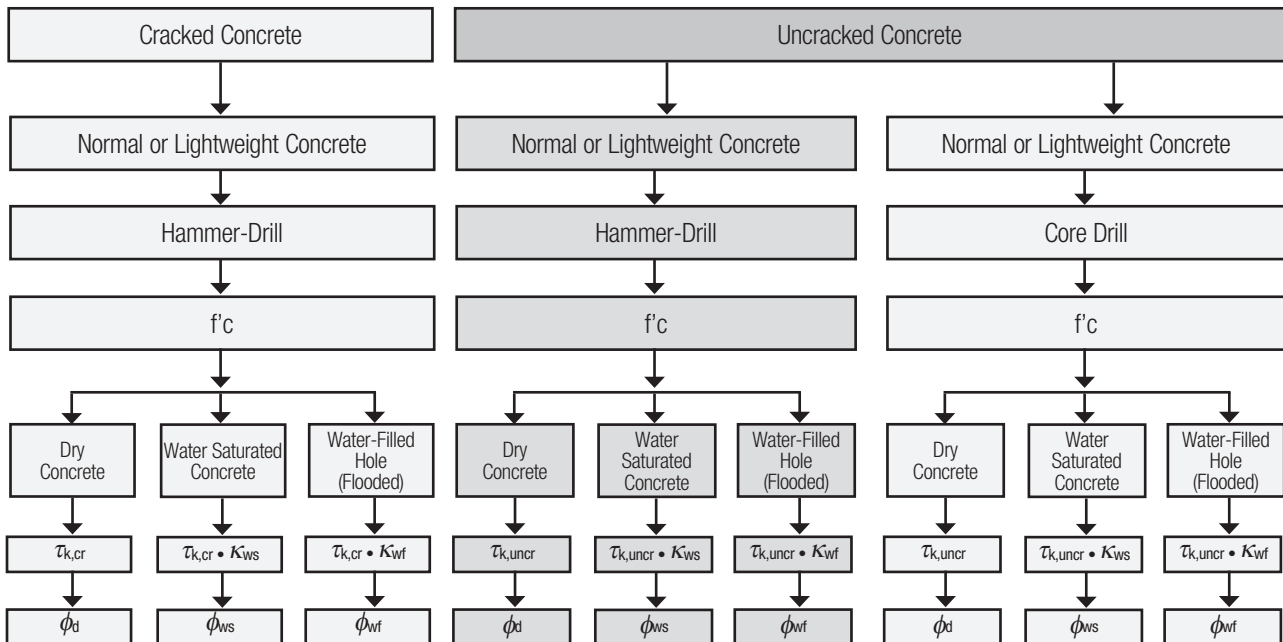



Bond Strength Design Information for Threaded Rods and Reinforcing Bars in Holes Drilled with a Hammer Drill and Carbide Bit (For use with load combinations taken from ACI 318-14 Section 5.3)¹

Design Information		Symbol	Units	Nominal Rod Diameter (inch) / Reinforcing Bar Size							
				3/8 or #3	1/2 or #4	5/8 or #5	3/4 or #6	7/8 or #7	1 or #8	#9	1 1/4 or #10
Minimum embedment		$h_{ef,min}$	inch (mm)	2-3/8 (60)	2-3/4 (70)	3-1/8 (79)	3-1/2 (89)	3-1/2 (89)	4 (102)	4-1/2 (114)	5 (127)
Maximum embedment	Dry concrete and saturated concrete ⁷	$h_{ef,max}$	inch (mm)	4-1/2 (114)	10 (254)	12-1/2 (318)	15 (381)	17-1/2 (445)	20 (508)	22-1/2 (572)	25 (635)
	Water-filled hole (flooded)	$h_{ef,max}$	inch (mm)	4-1/2 (114)	6 (152)	7-1/2 (190)	9 (225)	10-1/2 (267)	12 (305)	13-1/2 (343)	15 (381)
110°F (43°C) Maximum Long-Term Service Temperature; 140°F (60°C) Maximum Short-Term Service Temperature ^{2,4}	Characteristic bond strength in cracked concrete ^{5,8}	$\tau_{k,cr}$	psi (N/mm ²)	N/A	576 (4.0)	474 (3.3)	441 (3.0)	416 (2.9)	416 (2.9)	416 (2.9)	416 (2.9)
	Characteristic bond strength in uncracked concrete ^{5,9}	$\tau_{k,uncr}$	psi (N/mm ²)	1,223 (8.4)	1,156 (8.0)	1,106 (7.6)	1,067 (7.4)	1,036 (7.1)	1,010 (7.0)	986 (6.8)	966 (6.7)
110°F (43°C) Maximum Long-Term Service Temperature; 176°F (80°C) Maximum Short-Term Service Temperature ^{3,4}	Characteristic bond strength in cracked concrete ^{5,8}	$\tau_{k,cr}$	psi (N/mm ²)	N/A	455 (3.1)	374 (2.6)	349 (2.4)	329 (2.3)	329 (2.3)	329 (2.3)	329 (2.3)
	Characteristic bond strength in uncracked concrete ^{5,9}	$\tau_{k,uncr}$	psi (N/mm ²)	966 (6.7)	913 (6.3)	874 (6.0)	843 (5.8)	819 (5.6)	798 (5.5)	779 (5.4)	763 (5.3)
Permissible installation conditions ⁶	Dry concrete	ϕ_b	-	0.65	0.65	0.65	0.65	0.65	0.65	0.65	0.65
	Water-saturated concrete	ϕ_{ws}	-	0.45	0.45	0.45	0.45	0.45	0.45	0.45	0.45
		κ_{ws}	-	0.93	0.9	0.96	1.0	1.0	1.0	1.0	0.99
	Water-filled hole (flooded)	ϕ_{wf}	-	0.45	0.45	0.45	0.45	0.45	0.45	0.45	0.45
κ_{wf}		-	0.93	0.83	0.75	0.70	0.65	0.62	0.59	0.56	
Reduction factor for seismic tension		$\alpha_{N,seis}$	-	1.0							

For SI: 1 inch = 25.4 mm, 1 psi = 0.006894 MPa. For pound-inch units: 1 mm = 0.03937 inch, 1 MPa = 145.0 psi.

- Bond strength values correspond to a normal-weight concrete compressive strength $f'_c = 2,500$ psi (17.2 MPa). For concrete compressive strength, f'_c between 2,500 psi and 8,000 psi (17.2 MPa and 55.2 MPa), the tabulated characteristic bond strength may be increased by a factor of $(f'_c / 2,500)^{0.12}$ [For SI: $(f'_c / 17.2)^{0.12}$].
- The maximum short-term service temperature may be increased to 162°F (72°C) provided characteristic bond strengths are reduced by 10 percent. Long-term and short-term temperatures meet the requirements of Section 8.5 of ACI 355.4 and Table 8.1, Temperature Category B.
- Long-term and short-term temperatures meet the requirements of Section 8.5 of ACI 355.4 and Table 8.1, Temperature Category A.
- Short-term base material service temperatures are those that occur over brief intervals, e.g. as a result of diurnal cycling. Long-term base material service temperatures are roughly constant over significant periods of time.
- Characteristic bond strengths are for sustained loads including dead and live loads.
- Permissible installation conditions include dry concrete, water-saturated concrete and water-filled holes. Water-filled holes include applications in dry or water-saturated concrete where the drilled holes contain standing water at the time of anchor installation.
- Maximum embedment is limited to twelve anchor diameters for horizontal and upwardly inclined installations.
- For structures assigned to Seismic Design Categories C, D, E or F, bond strength values for cracked concrete do not require an additional reduction factor applied for seismic tension ($\alpha_{N,seis} = 1.0$), where seismic design is applicable.
- Bond strength values for uncracked concrete are applicable for structures assigned to Seismic Design Categories A and B only.



ADHESIVES

PE1000+
Epoxy Injection Adhesive Anchoring System

Bond Strength Design Information for Threaded Rods and Reinforcing Bars in Holes Drilled with a Core Drill and Diamond Core Bit (For use with load combinations taken from ACI 318-14 Section 5.3)¹

Design Characteristic	Notation	Units	Nominal Rod Diameter (inch) / Reinforcing Bar Size					
			1/2" or #4	5/8" or #5	3/4" or #6	7/8" or #7	1" or #8	
Minimum embedment	$h_{ef,min}$	in. (mm)	2-3/4 (70)	3-1/8 (79)	3-1/2 (89)	3-1/2 (89)	4 (102)	
Maximum embedment ⁷	$h_{ef,max}$	in. (mm)	10 (54)	12-1/2 (318)	15 (381)	17-1/2 (445)	20 (508)	
110°F (43°C) Maximum Long-Term Service Temperature; 140°F (60°C) Maximum Short-Term Service Temperature ^{2,4}	Characteristic bond strength in uncracked concrete ^{5,8}	$\tau_{k,uncr}$	psi (N/mm ²)	1,133 (7.8)	1,075 (7.4)	1,033 (7.1)	1,022 (6.9)	975 (6.7)
110°F (43°C) Maximum Long-Term Service Temperature; 176°F (80°C) Maximum Short-Term Service Temperature ^{3,4}				895 (6.2)	849 (5.9)	816 (5.6)	791 (5.5)	770 (5.3)
Permissible Installation Conditions ⁶	Dry concrete	ϕ_{cl}	-	0.55	0.45	0.45	0.45	0.45
	Water-saturated concrete	ϕ_{ws}	-	0.45	0.45	0.45	0.45	0.45
		K_{ws}	-	1.0	1.0	1.0	1.0	1.0
	Water-filled hole (flooded)	ϕ_{ws}	-	0.45	0.45	0.45	0.45	0.45
K_{wf}		-	0.94	0.95	0.95	0.95	0.96	

For SI: 1 inch = 25.4 mm, 1 psi = 0.006894 MPa. For pound-inch units: 1 mm = 0.03937 inch, 1 MPa = 145.0 psi.

- Bond strength values correspond to a normal-weight concrete compressive strength $f'_c = 2,500$ psi (17.2 MPa). For concrete compressive strength, f'_c between 2,500 psi and 8,000 psi (17.2 MPa and 55.2 MPa), the tabulated characteristic bond strength may be increased by a factor of $(f'_c / 2,500)^{0.12}$ [For SI: $(f'_c / 17.2)^{0.12}$].
- The maximum short-term service temperature may be increased to 162°F (72°C) provided characteristic bond strengths are reduced by 10 percent. Long-term and short-term temperatures meet the requirements of Section 8.5 of ACI 355.4 and Table 8.1, Temperature Category B.
- Long-term and short-term temperatures meet the requirements of Section 8.5 of ACI 355.4 and Table 8.1, Temperature Category A.
- Short-term base material service temperatures are those that occur over brief intervals, e.g. as a result of diurnal cycling. Long-term base material service temperatures are roughly constant over significant periods of time.
- Characteristic bond strengths are for sustained loads including dead and live loads.
- Permissible installation conditions include dry concrete, water-saturated concrete and water-filled holes. Water-filled holes include applications in dry or water-saturated concrete where the drilled holes contain standing water at the time of anchor installation.
- Maximum embedment is limited to twelve anchor diameters for horizontal and upwardly inclined installations.
- For structures assigned to Seismic Design Categories C, D, E or F, bond strength values for cracked concrete do not require an additional reduction factor applied for seismic tension ($\alpha_{M,seis} = 1.0$), where seismic design is applicable.
- Bond strength values for uncracked concrete are applicable for structures assigned to Seismic Design Categories A and B only.



Tension and Shear Design Strength Installed in Uncracked Concrete (Bond or Concrete Strength)
Drilled with a Hammer-Drill and Carbide Bit in a Dry Hole Condition
110°F (43°C) Maximum Long-Term Service Temperature;
140°F (60°C) Maximum Short-Term Service Temperature^{1,2,3,4,5,6,7,8,9}

Nominal Rod/Rebar Size (in. or #)	Embed. Depth h_{ef} (in.)	Minimum Concrete Compressive Strength									
		f'c = 2,500 psi		f'c = 3,000 psi		f'c = 4,000 psi		f'c = 6,000 psi		f'c = 8,000 psi	
		Φ_{Ncb} or Φ_{Na} Tension (lbs.)	Φ_{Vcb} or Φ_{Vcp} Shear (lbs.)	Φ_{Ncb} or Φ_{Na} Tension (lbs.)	Φ_{Vcb} or Φ_{Vcp} Shear (lbs.)	Φ_{Ncb} or Φ_{Na} Tension (lbs.)	Φ_{Vcb} or Φ_{Vcp} Shear (lbs.)	Φ_{Ncb} or Φ_{Na} Tension (lbs.)	Φ_{Vcb} or Φ_{Vcp} Shear (lbs.)	Φ_{Ncb} or Φ_{Na} Tension (lbs.)	Φ_{Vcb} or Φ_{Vcp} Shear (lbs.)
3/8 or #3	2-3/8	2,225	2,330	2,275	2,450	2,355	2,535	2,470	2,660	2,555	2,755
	3	2,810	3,460	2,870	3,825	2,975	4,480	3,120	5,595	3,230	6,550
	4-1/2	4,215	6,320	4,310	6,985	4,460	8,175	4,680	10,085	4,845	10,435
1/2 or #4	2-3/4	3,245	3,185	3,320	3,520	3,435	4,120	3,605	5,145	3,730	6,025
	4	4,720	5,990	4,825	6,620	4,995	7,755	5,245	9,680	5,430	11,335
	6	7,080	10,915	7,240	12,065	7,495	14,125	7,865	16,945	8,145	17,540
	10	11,805	23,250	12,065	25,690	12,490	26,895	13,110	28,240	13,570	29,230
5/8 or #5	3-1/8	4,310	4,120	4,510	4,595	4,665	5,375	4,900	6,715	5,070	7,860
	5	7,060	9,175	7,215	10,140	7,465	11,870	7,840	14,825	8,115	17,355
	7-1/2	10,585	16,710	10,820	18,465	11,200	21,620	11,760	25,330	12,170	26,220
	12-1/2	17,645	35,610	18,035	38,845	18,670	40,210	19,600	42,215	20,285	43,695
3/4 or #6	3-1/2	5,105	5,015	5,480	5,700	5,735	6,790	6,000	8,480	6,195	9,925
	6	9,805	12,775	10,020	14,115	10,375	16,525	10,890	20,635	11,275	24,160
	9	14,705	23,265	15,035	25,710	15,560	30,100	16,335	35,185	16,910	36,420
	15	24,510	49,560	25,055	53,965	25,935	55,860	27,225	58,645	28,185	60,705
7/8 or #7	3-1/2	5,085	4,930	5,290	5,605	5,625	6,855	5,980	8,765	6,175	10,260
	7	12,960	15,900	13,245	17,570	13,710	20,570	14,395	25,690	14,900	30,075
	10-1/2	19,435	28,960	19,865	32,000	20,565	37,465	21,590	46,500	22,350	48,135
	17-1/2	32,395	61,700	33,110	68,185	34,275	73,820	35,985	77,500	37,245	80,225
1 or #8	4	6,240	6,115	6,685	6,945	7,110	8,495	7,645	11,045	7,895	12,930
	8	16,500	19,225	16,865	21,245	17,455	24,870	18,325	31,060	18,970	36,360
	12	24,750	35,010	25,295	38,690	26,185	45,295	27,490	56,570	28,455	61,290
	20	41,250	74,605	42,160	82,440	43,640	94,000	45,820	98,685	47,430	102,150
#9	4-1/2	7,445	7,110	8,105	8,080	8,615	9,880	9,350	13,025	9,655	15,250
	9	20,385	22,755	20,835	25,145	21,570	29,440	22,645	36,765	23,440	43,045
	13-1/2	30,580	41,450	31,255	45,805	32,355	53,630	33,965	66,970	35,160	75,730
	22-1/2	50,965	88,290	52,095	97,570	53,920	114,230	56,610	121,930	58,600	126,215
1-1/4	5	8,720	8,170	9,555	9,285	10,495	11,355	11,450	15,085	11,870	17,755
	10	24,660	26,380	25,205	29,150	26,090	34,130	27,390	42,620	28,350	49,895
	15	36,985	48,045	37,805	53,090	39,130	62,155	41,085	77,625	42,525	90,880
	25	61,645	102,380	63,005	113,140	65,220	132,460	68,470	147,480	70,875	152,660
#10	5	8,720	8,160	9,555	9,270	10,375	11,335	11,315	15,060	11,725	17,725
	10	24,660	26,425	25,205	29,200	26,090	34,190	27,390	42,695	28,350	49,985
	15	36,985	48,130	37,805	53,190	39,130	62,270	41,085	77,765	42,525	91,045
	25	61,645	102,530	63,005	113,305	65,220	132,655	68,470	147,480	70,875	152,660

■ - Concrete Breakout Strength ■ - Bond Strength/Pryout Strength

- Tabular values are provided for illustration and are applicable for single anchors installed in uncracked normal-weight concrete with minimum slab thickness, $h_{sa} = h_{min}$, and with the following conditions:
 - C_{a1} is greater than or equal to the critical edge distance, C_{a2}
 - C_{a2} is greater than or equal to 1.5 times C_{a1} .
- Calculations were performed according to ACI 318-14 Ch.17 and ICC-ES AC308. The load level corresponding to the failure mode listed [Concrete breakout strength, bond strength/pryout strength] must be checked against the tabulated steel strength of the corresponding threaded rod or rebar size and type, the lowest load level controls.
- Strength reduction factors (ϕ) for concrete breakout strength are based on ACI 318-14 Section 5.3 for load combinations. Condition B was assumed.
- Strength reduction factors (ϕ) for bond strength are determined from reliability testing and qualification in accordance with ICC-ES AC308 and are tabulated in this product information and in ESR-2583.
- Tabular values are permitted for static loads only, seismic loading is not considered with these tables. Periodic special inspection must be performed where required by code, see ESR-2583 for applicable information.
- For anchors subjected to tension resulting from sustained loading a supplemental check must be performed according to ACI 318-14 17.3.1.2.
- For designs that include combined tension and shear, the interaction of tension and shear loads must be calculated in accordance with ACI 318-14 Ch.17.
- Interpolation is not permitted to be used with the tabular values. For intermediate base material compressive strengths, please see ACI 318-14 Ch.17, ICC-ES AC308 and information included in this product supplement. For other design conditions including seismic considerations please see ACI 318-14 Ch.17 and ICC-ES AC308 and ESR-2583.
- Long term concrete temperatures are roughly constant over significant periods of time. Short-term elevated temperatures are those that occur over brief intervals, e.g. as a result of diurnal cycling.

ADHESIVES

PE1000+
Epoxy Injection Adhesive Anchoring System



**Tension and Shear Design Strength Installed in Cracked Concrete (Bond or Concrete Strength)
Drilled with a Hammer-Drill and Carbide Bit in a Dry Hole Condition
110°F (43°C) Maximum Long-Term Service Temperature;
140°F (60°C) Maximum Short-Term Service Temperature**^{1,2,3,4,5,6,7,8,9}

Nominal Rod/Rebar Size (in. or #)	Embed. Depth h_{ef} (in.)	Minimum Concrete Compressive Strength									
		$f'_c = 2,500$ psi		$f'_c = 3,000$ psi		$f'_c = 4,000$ psi		$f'_c = 6,000$ psi		$f'_c = 8,000$ psi	
		Φ_{Ncb} or Φ_{Na} Tension (lbs.)	Φ_{Vcb} or Φ_{Vcp} Shear (lbs.)	Φ_{Ncb} or Φ_{Na} Tension (lbs.)	Φ_{Vcb} or Φ_{Vcp} Shear (lbs.)	Φ_{Ncb} or Φ_{Na} Tension (lbs.)	Φ_{Vcb} or Φ_{Vcp} Shear (lbs.)	Φ_{Ncb} or Φ_{Na} Tension (lbs.)	Φ_{Vcb} or Φ_{Vcp} Shear (lbs.)	Φ_{Ncb} or Φ_{Na} Tension (lbs.)	Φ_{Vcb} or Φ_{Vcp} Shear (lbs.)
1/2 or #4	2-3/4	1,615	2,275	1,655	2,515	1,710	2,945	1,795	3,675	1,860	4,005
	4	2,350	4,280	2,405	4,730	2,490	5,360	2,615	5,630	2,705	5,825
	6	3,530	7,600	3,605	7,770	3,735	8,040	3,920	8,440	4,055	8,740
	10	5,880	12,665	6,010	12,945	6,220	13,400	6,535	14,070	6,760	14,565
5/8 or #5	3-1/8	1,890	2,940	1,930	3,280	2,000	3,840	2,100	4,525	2,175	4,680
	5	3,025	6,515	3,090	6,660	3,200	6,895	3,360	7,235	3,480	7,490
	7-1/2	4,535	9,770	4,640	9,990	4,800	10,340	5,040	10,855	5,215	11,235
	12-1/2	7,560	16,285	7,730	16,645	8,000	17,230	8,400	18,090	8,695	18,725
3/4 or #6	3-1/2	2,175	3,580	2,265	4,070	2,370	4,850	2,480	5,340	2,560	5,515
	6	4,050	8,730	4,140	8,920	4,290	9,235	4,500	9,695	4,660	10,035
	9	6,080	13,090	6,215	13,380	6,430	13,850	6,750	14,545	6,990	15,055
	15	10,130	21,820	10,355	22,305	10,720	23,085	11,255	24,240	11,650	25,090
7/8 or #7	3-1/2	2,045	3,525	2,125	4,000	2,260	4,865	2,400	5,170	2,480	5,340
	7	5,205	11,205	5,320	11,455	5,505	11,855	5,780	12,450	5,980	12,885
	10-1/2	7,805	16,810	7,975	17,180	8,255	17,785	8,670	18,670	8,975	19,330
	17-1/2	13,010	28,015	13,295	28,635	13,760	29,640	14,450	31,120	14,955	32,215
1 or #8	4	2,650	4,365	2,755	4,960	2,930	6,065	3,150	6,780	3,250	7,005
	8	6,795	13,730	6,945	14,960	7,190	15,485	7,550	16,260	7,815	16,830
	12	10,195	21,955	10,420	22,440	10,785	23,230	11,325	24,390	11,720	25,245
	20	16,990	36,595	17,365	37,405	17,975	38,715	18,870	40,645	19,535	42,075
#9	4-1/2	3,290	5,080	3,420	5,770	3,635	7,060	3,945	8,495	4,075	8,775
	9	8,600	16,255	8,790	17,960	9,100	19,600	9,555	20,575	9,890	21,300
	13-1/2	12,900	27,790	13,185	28,405	13,650	29,400	14,330	30,865	14,835	31,950
	22-1/2	21,505	46,315	21,980	47,340	22,750	49,000	23,885	51,445	24,725	53,250
1-1/4	5	4,090	5,835	4,250	6,630	4,520	8,110	4,930	10,620	5,110	11,010
	10	10,620	18,840	10,855	20,820	11,235	24,200	11,795	25,405	12,210	26,295
	15	15,930	34,305	16,280	35,065	16,850	36,295	17,690	38,105	18,315	39,445
	25	26,545	57,175	27,135	58,440	28,085	60,495	29,485	63,510	30,525	65,740
#10	5	4,045	5,830	4,205	6,620	4,465	8,100	4,870	10,495	5,050	10,880
	10	10,620	18,875	10,855	20,860	11,235	24,200	11,795	25,405	12,210	26,295
	15	15,930	34,305	16,280	35,065	16,850	36,295	17,690	38,105	18,315	39,445
	25	26,545	57,175	27,135	58,440	28,085	60,495	29,485	63,510	30,525	65,740

■ - Concrete Breakout Strength □ - Bond Strength/Pryout Strength

- Tabular values are provided for illustration and are applicable for single anchors installed in cracked normal-weight concrete with minimum slab thickness, $h_a = h_{min}$, and with the following conditions:
 - C_{a1} is greater than or equal to the critical edge distance, C_{ac}
 - C_{a2} is greater than or equal to 1.5 times C_{a1} .
- Calculations were performed according to ACI 318-14 Ch.17 and ICC-ES AC308. The load level corresponding to the failure mode listed [Concrete breakout strength, bond strength/pryout strength] must be checked against the tabulated steel strength of the corresponding threaded rod or rebar size and type, the lowest load level controls.
- Strength reduction factors (ϕ) for concrete breakout strength are based on ACI 318-14 Section 5.3 for load combinations. Condition B was assumed.
- Strength reduction factors (ϕ) for bond strength are determined from reliability testing and qualification in accordance with ICC-ES AC308 and are tabulated in this product information and in ESR-2583.
- Tabular values are permitted for static loads only, seismic loading is not considered with these tables. Periodic special inspection must be performed where required by code, see ESR-2583 for applicable information.
- For anchors subjected to tension resulting from sustained loading a supplemental check must be performed according to ACI 318-14 17.3.1.2.
- For designs that include combined tension and shear, the interaction of tension and shear loads must be calculated in accordance with ACI 318-14 Ch.17.
- Interpolation is not permitted to be used with the tabular values. For intermediate base material compressive strengths, please see ACI 318-14 Ch.17, ICC-ES AC308 and information included in this product supplement. For other design conditions including seismic considerations please see ACI 318-14 Ch.17 and ICC-ES AC308 and ESR-2583.
- Long term concrete temperatures are roughly constant over significant periods of time. Short-term elevated temperatures are those that occur over brief intervals, e.g. as a result of diurnal cycling.



**Tension and Shear Design Strength Installed in Uncracked Concrete (Bond or Concrete Strength)
Drilled with a Core-Drill and Diamond Core Bit in a Dry Hole Condition
110°F (43°C) Maximum Long-Term Service Temperature;
140°F (60°C) Maximum Short-Term Service Temperature**^{1,2,3,4,5,6,7,8,9}

Nominal Rod/Rebar Size (in. or #)	Embed. Depth h_{ef} (in.)	Minimum Concrete Compressive Strength									
		$f'c = 2,500$ psi		$f'c = 3,000$ psi		$f'c = 4,000$ psi		$f'c = 6,000$ psi		$f'c = 8,000$ psi	
		Φ_{Ncb} or Φ_{Na} Tension (lbs.)	Φ_{Vcb} or Φ_{Vcp} Shear (lbs.)	Φ_{Ncb} or Φ_{Na} Tension (lbs.)	Φ_{Vcb} or Φ_{Vcp} Shear (lbs.)	Φ_{Ncb} or Φ_{Na} Tension (lbs.)	Φ_{Vcb} or Φ_{Vcp} Shear (lbs.)	Φ_{Ncb} or Φ_{Na} Tension (lbs.)	Φ_{Vcb} or Φ_{Vcp} Shear (lbs.)	Φ_{Ncb} or Φ_{Na} Tension (lbs.)	Φ_{Vcb} or Φ_{Vcp} Shear (lbs.)
1/2 or #4	2-3/4	2,690	3,160	2,750	3,490	2,850	4,085	2,990	5,105	3,095	5,975
	4	3,915	5,945	4,000	6,570	4,145	7,690	4,350	9,605	4,500	11,245
	6	5,875	10,830	6,005	11,965	6,215	14,010	6,525	16,605	6,755	17,190
	10	9,790	23,065	10,005	25,465	10,355	26,360	10,875	27,675	11,255	28,650
5/8 or #5	3-1/8	2,970	4,110	3,035	4,540	3,140	5,320	3,295	6,640	3,410	7,775
	5	4,750	9,090	4,855	10,045	5,025	11,760	5,275	14,685	5,460	16,990
	7-1/2	7,125	16,555	7,280	18,290	7,535	21,415	7,915	24,620	8,190	25,485
	12-1/2	11,875	35,260	12,135	37,755	12,560	39,080	13,190	41,030	13,650	42,470
3/4 or #6	3-1/2	3,570	5,015	3,720	5,700	3,855	6,700	4,030	8,370	4,160	9,800
	6	6,570	12,610	6,715	13,935	6,955	16,310	7,300	20,370	7,555	23,510
	9	9,855	22,965	10,075	25,375	10,430	29,710	10,950	34,065	11,335	35,260
	15	16,430	48,925	16,795	52,245	17,380	54,080	18,250	56,775	18,890	58,770
7/8 or #7	3-1/2	3,445	4,930	3,580	5,605	3,810	6,855	4,015	8,645	4,145	10,125
	7	8,675	15,690	8,870	17,340	9,180	20,300	9,635	25,350	9,975	29,675
	10-1/2	13,015	28,575	13,300	31,580	13,770	36,970	14,455	44,975	14,965	46,555
	17-1/2	21,690	60,885	22,170	67,280	22,950	71,400	24,095	74,960	24,940	77,590
1 or #8	4	4,350	6,115	4,520	6,945	4,810	8,495	5,120	10,890	5,290	12,745
	8	11,025	18,955	11,270	20,945	11,665	24,520	12,250	30,625	12,680	35,855
	12	16,540	34,520	16,905	38,150	17,500	44,665	18,375	55,775	19,020	59,165
	20	27,565	73,560	28,175	81,285	29,165	90,740	30,620	95,265	31,695	98,610

■ - Concrete Breakout Strength ■ - Bond Strength/Pryout Strength

- Tabular values are provided for illustration and are applicable for single anchors installed in uncracked normal-weight concrete with minimum slab thickness, $h_a = h_{min}$, and with the following conditions:
 - C_{a1} is greater than or equal to the critical edge distance, C_{ac}
 - C_{a2} is greater than or equal to 1.5 times C_{a1} .
- Calculations were performed according to ACI 318-14 Ch.17 and ICC-ES AC308. The load level corresponding to the failure mode listed [Concrete breakout strength, bond strength/pryout strength] must be checked against the tabulated steel strength of the corresponding threaded rod or rebar size and type, the lowest load level controls.
- Strength reduction factors (ϕ) for concrete breakout strength are based on ACI 318-14 Section 5.3 for load combinations. Condition B was assumed.
- Strength reduction factors (ϕ) for bond strength are determined from reliability testing and qualification in accordance with ICC-ES AC308 and are tabulated in this product information and in ESR-2583.
- Tabular values are permitted for static loads only, seismic loading is not considered with these tables. Periodic special inspection must be performed where required by code, see ESR-2583 for applicable information.
- For anchors subjected to tension resulting from sustained loading a supplemental check must be performed according to ACI 318-14 17.3.1.2.
- For designs that include combined tension and shear, the interaction of tension and shear loads must be calculated in accordance with ACI 318-14 Ch.17.
- Interpolation is not permitted to be used with the tabular values. For intermediate base material compressive strengths, please see ACI 318-14 Ch.17, ICC-ES AC308 and information included in this product supplement. For other design conditions including seismic considerations please see ACI 318-14 Ch.17 and ICC-ES AC308 and ESR-2583.
- Long term concrete temperatures are roughly constant over significant periods of time. Short-term elevated temperatures are those that occur over brief intervals, e.g. as a result of diurnal cycling.



Tension Design of Steel Elements (Steel Strength)^{1,2}

Steel Elements - Threaded Rod and Reinforcing Bar										
Nominal Rod/Rebar Size (in. or No.)	ASTM A36 and ASTM F1554 Grade 36	ASTM F1554 Grade 55	ASTM A193 Grade B7 and ASTM F1554 Grade 105	ASTM F593 CW Stainless (Types 304 and 316)	ASTM A193 Grade B8/ B8M, Class 1 Stainless (Types 304 and 316)	ASTM A193 Grade B8/ B8M2, Class 2B Stainless (Types 304 and 316)	ASTM A615 Grade 75 Rebar	ASTM A615 Grade 60 Rebar	ASTM A706 Grade 60 Rebar	ASTM A615 Grade 40 Rebar
	ϕN_{sa} Tension (lbs.)	ϕN_{sa} Tension (lbs.)	ϕN_{sa} Tension (lbs.)	ϕN_{sa} Tension (lbs.)	ϕN_{sa} Tension (lbs.)	ϕN_{sa} Tension (lbs.)	ϕN_{sa} Tension (lbs.)	ϕN_{sa} Tension (lbs.)	ϕN_{sa} Tension (lbs.)	ϕN_{sa} Tension (lbs.)
3/8 or #3	3,370	4,360	7,265	5,040	3,315	5,525	7,150	7,425	6,600	4,950
1/2 or #4	6,175	7,980	13,300	9,225	6,070	10,110	13,000	13,500	12,000	9,000
5/8 or #5	9,835	12,715	21,190	14,690	9,660	16,105	20,150	20,925	18,600	13,950
3/4 or #6	14,550	18,815	31,360	18,480	14,300	23,830	28,600	29,700	26,400	19,800
7/8 or #7	20,085	25,970	43,285	25,510	19,735	32,895	39,000	40,500	36,000	-
1 or #8	26,350	34,070	56,785	33,465	25,895	43,160	51,350	53,325	47,400	-
#9	-	-	-	-	-	-	65,000	67,500	60,000	-
1-1/4 or #10	42,160	54,510	90,850	53,540	41,430	69,050	82,550	85,725	76,200	-

■ - Steel Strength

1. Steel tensile design strength according to ACI 318-14 Ch. 17, $\phi N_{sa} = \phi \cdot A_{se,N} \cdot f_{uta}$
2. The tabulated steel design strength in tension must be checked against the bond strength/concrete capacity design strength to determine the controlling failure mode, the lowest load level controls.

Shear Design of Steel Elements (Steel Strength)^{1,2}

Steel Elements - Threaded Rod and Reinforcing Bar										
Nominal Rod/Rebar Size (in. or No.)	ASTM A36 and ASTM F1554 Grade 36	ASTM F1554 Grade 55	ASTM A193 Grade B7 and ASTM F1554 Grade 105	ASTM F593 CW Stainless (Types 304 and 316)	ASTM A193 Grade B8/ B8M, Class 1 Stainless (Types 304 and 316)	ASTM A193 Grade B8/ B8M2, Class 2B Stainless (Types 304 and 316)	ASTM A615 Grade 75 Rebar	ASTM A615 Grade 60 Rebar	ASTM A706 Grade 60 Rebar	ASTM A615 Grade 40 Rebar
	ϕV_{sa} Tension (lbs.)	ϕV_{sa} Tension (lbs.)	ϕV_{sa} Tension (lbs.)	ϕV_{sa} Tension (lbs.)	ϕV_{sa} Tension (lbs.)	ϕV_{sa} Tension (lbs.)	ϕV_{sa} Tension (lbs.)	ϕV_{sa} Tension (lbs.)	ϕV_{sa} Tension (lbs.)	ϕV_{sa} Tension (lbs.)
3/8 or #3	1,755	2,265	3,775	2,790	1,725	2,870	3,960	3,860	3,430	2,575
1/2 or #4	3,210	4,150	6,915	5,110	3,155	5,255	7,200	7,020	6,240	4,680
5/8 or #5	5,115	6,610	11,020	8,135	5,025	8,375	11,160	10,880	9,670	7,255
3/4 or #6	7,565	9,785	16,305	10,235	7,435	12,390	15,840	15,445	13,730	10,295
7/8 or #7	10,445	13,505	22,505	14,130	10,265	17,105	21,600	21,060	18,720	-
1 or #8	13,700	17,715	29,525	18,535	13,465	22,445	28,440	27,730	24,650	-
#9	-	-	-	-	-	-	36,000	35,100	31,200	-
1-1/4 or #10	21,920	28,345	47,240	29,655	21,545	35,905	45,720	44,575	39,625	-

■ - Steel Strength

1. Steel shear design strength according to ACI 318-14 Ch. 17, $\phi V_{sa} = \phi \cdot 0.60 \cdot A_{se,N} \cdot f_{uta}$
2. The tabulated steel design strength in shear must be checked against the bond strength/concrete capacity design strength to determine the controlling failure mode, the lowest load level controls.

INSTALLATION INSTRUCTIONS (SOLID BASE MATERIALS)

HAMMER DRILLING

DRILLING

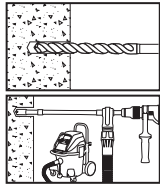

1- Drill a hole into the base material with rotary hammer drill (i.e. percussion drill) and a carbide drill bit to the size and embedment required by the selected steel hardware element (reference installation specifications for threaded rod and reinforcing bar). The tolerances of the carbide drill bits, including hollow bits, must meet ANSI Standard B212.15.

• Precaution: Use suitable eye and skin protection. Avoid inhalation of dust during drilling and/or removal.

• **Note!** In case of standing water in the drilled hole (flooded hole condition), all the water has to be removed from the hole (e.g. vacuum, compressed air, etc.) prior to cleaning.

Drilling in dry base materials is recommended when using hollow drill bits (vacuum must be on).

HOLE CLEANING (BLOW 4X, BRUSH 4X, BLOW 4X)

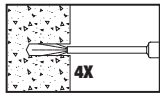

2a- Starting from the bottom or back of the drilled anchor hole, blow the hole clean using a compressed air nozzle (min. 90 psi) or a hand pump (supplied by DEWALT) a minimum of four times (4x).

• Use a compressed air nozzle (min. 90 psi) or a hand pump (min. volume 25 fl. oz.) for anchor rod 3/8" to 3/4" diameter or reinforcing bar (rebar) sizes #3 to #6.

• Use a compressed air nozzle (min. 90 psi) for anchor rod 7/8" to 1-1/4" diameter and rebar sizes #7 to #10. A hand pump shall not be used with these anchor sizes.

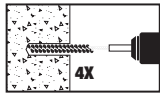

2b- Determine wire brush diameter (reference hole cleaning equipment selection table) and attach the brush with adaptor to a rotary drill tool or battery screw gun. Brush the hole with the selected wire brush a minimum of four times (4x). A brush extension (supplied by DEWALT, Cat. #08282) should be used for holes drilled deeper than the listed brush length.

• The wire brush diameter must be checked periodically during use. The brush should resist insertion into the drilled hole and come into contact with the sides of the drilled hole. If not the brush is too small and must be replaced.

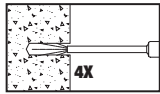

2c- Finally, blow the hole clean again a minimum of four times (4x).

• Use a compressed air nozzle (min. 90 psi) or a hand pump (min. volume 25 fl. oz.) for anchor rod 3/8" to 3/4" diameter or reinforcing bar (rebar) sizes #3 to #6.

• Use a compressed air nozzle (min. 90 psi) for anchor rod 7/8" to 1-1/4" diameter and rebar sizes #7 to #10. A hand pump shall not be used with these anchor sizes.

When finished the hole should be clean and free of dust, debris, ice, grease, oil or other foreign material.

NEXT GO TO STEP 3.

CORE DRILLING

DRILLING

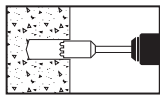

1- Drill a hole into the base material with a core drill tool to the size and embedment required by the selected steel hardware element (reference installation table). The tolerances of the carbide drill bit must meet ANSI Standard B212.15.

• Precaution: Use suitable eye and skin protection. Avoid inhalation of dust during drilling and/or removal.

HOLE CLEANING (RINSE, BRUSH 4X, RINSE, BLOW 4X, BRUSH 4X, BLOW 4X)

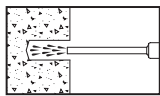

2a- Starting from the bottom or back of the drilled anchor hole, rinse/flush the hole clean with water (water line pressure) until clear water comes out.

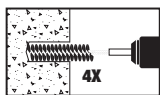

2b- Determine brush diameter (see installation table) for drilled hole and attach the brush with adaptor to a rotary drill tool or battery screw gun. Brush the hole with the selected wire brush a minimum of four times (4x). A brush extension (supplied by DEWALT) must be used for holes drilled deeper than the listed brush length.

• The wire brush diameter must be checked periodically during use. The brush should resist insertion into the drilled hole and come into contact with the sides of the drilled hole. If not the brush is too small and must be replaced.

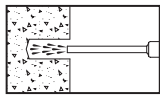

2c- Repeat Step 2a again by rinse/flush the hole clean with water.

Following this remove all standing water completely (e.g. vacuum, compressed air, etc.) prior to further cleaning. To attain a dried borehole a DEWALT compressed air nozzle is recommended.

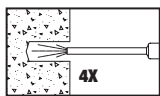

2d- Starting from the bottom or back of the drilled anchor hole, blow the hole clean (free of noticeable dust) a minimum if four times (4x). Use a compressed air nozzle (min. 90 psi) for all sizes of anchor rod and reinforcing bar (rebar)

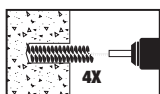

2e- Repeat Step 2b again by brushing the hole with a wire brush a minimum of four times (4x).

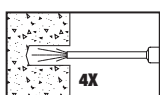

2f- Repeat Step 2d again by blowing the hole clean a minimum of four times (4x).

When finished the hole should be clean and free of dust, debris, ice, grease, oil or other foreign material.

NEXT GO TO STEP 3.

PREPARING



3- Check adhesive expiration date on cartridge label. Do not use expired product. Review Safety Data Sheet (SDS) before use. Cartridge temperature must be between 41°F - 95°F (5°C - 35°C) when in use; for downward applications only the adhesive temperature may be up to 104°F (40°C). Consideration should be given to the reduced gel time of the adhesive in warm temperatures.

- Attach a supplied mixing nozzle to the cartridge. Unless otherwise noted do not modify the mixer in any way and make sure the mixing element is inside the nozzle. Load the cartridge into the correct dispensing tool.
- A new mixing nozzle must be used for every working interruption longer than the published working times (reference gel time and curing time table) as well as for new cartridges.
- Note: Always use a new mixing nozzle with new cartridge of adhesive and also for all work interruptions exceeding the published gel (working) time of the adhesive.

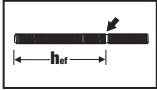

4- Prior to inserting the anchor rod or rebar into the filled bore hole, the position of the embedment depth has to be marked on the anchor. Verify anchor element is straight and free of surface damage.

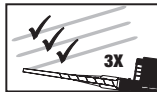

5- For new cartridges and nozzles: prior to dispensing into the anchor hole, squeeze out separately a minimum three full strokes of the mixed adhesive. Discard non-uniform adhesives until the adhesive is a consistent **RED** color.

- Review and note the published working and cure times (reference gel time and curing time table) prior to injection of the mixed adhesive into the cleaned anchor hole.

INSTALLATION

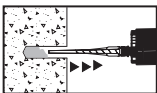

6- Fill the cleaned hole approximately two-thirds full with mixed adhesive starting from the bottom or back of the anchor hole. If the bottom or back of the anchor hole is not reached with the mixing nozzle only, a plastic extension tube must be used with the mixing nozzle (see reference tables for installation). Slowly withdraw the mixing nozzle as the hole fills to avoid creating air pockets or voids.

WITH PISTON PLUG:

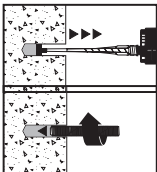

- Piston plugs (see adhesive piston plug table) must be used with and attached to the mixing nozzle and extension tube for horizontal and overhead installations with anchor rod from 5/8" to 1-1/4" diameter and rebar size #5 to #10. Insert piston plug to the back of the drilled hole and inject as described in the method above. During installation the piston plug will be naturally extruded from the drilled hole by the adhesive pressure.

- **Attention!** Do not install anchors overhead without proper training and installation hardware provided by the DEWALT. Contact DEWALT for details prior to use.

7- The anchor should be free of dirt, grease, oil or other foreign material. Push clean threaded rod or reinforcing bar into the anchor hole while turning slightly to ensure positive distribution of the adhesive until the embedment depth is reached. Air pockets are present when the threaded rod or rebar springs or air pockets burst during installation. In case of air pockets: remove rod or rebar, let the adhesive harden, re-drill the hole and repeat the complete installation.

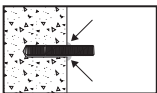

8- Be sure that the anchor is fully seated at the bottom of the hole to the specified embedment. Adhesive must completely fill the annular gap between the anchor and the base material. Protect the anchor element threads from fouling with adhesive. For all installations the rebar must be restrained from movement throughout the specified curing period (as necessary) where necessary through the use of temporary wedges, external supports, or other methods. Minor adjustments to the position of the anchor element may be performed during the gel (working) time only.

CURING AND LOADING

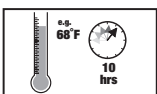

9- Allow the adhesive anchor to cure to the specified full curing time prior to applying any load (reference gel time and curing time table).

- Do not disturb, torque or load the anchor until it is fully cured.



10- After full curing of the adhesive anchor, a fixture can be installed to the anchor and tightened up to the maximum torque (reference gel time and curing table) by using a calibrated torque wrench.

- Take care not to exceed the maximum torque for the selected anchor.

REFERENCE TABLES FOR INSTALLATION

Gel (working) Time and Curing Table

Temperature of Base Material		Gel (working) Time	Full Curing Time
°F	°C		
41	5	180 minutes	50 hours
50	10	120 minutes	30 hours
68	20	30 minutes	10 hours
86	30	20 minutes	6 hours
95	35	15 minutes	5 hours
104	40	12 minutes	4 hours

Cartridge adhesive temperature must be between 41°F - 95°F (5°C - 35°C) when in use; for downward applications only the cartridge adhesive temperature may be up to 104°F (40°C).

Hole Cleaning Equipment Selection Table for PE1000+^{1,2,3}

Threaded rod diameter (inch)	Rebar size (no.)	ANSI drill bit diameter (inch)	Core drill bit diameter (inch)	Brush length (inches)	Steel wire brush (Cat. #)	Blowout tool	Number of cleaning actions
3/8	#3	7/16	7/16	6-3/4	08284	Hand-pump or compressed air nozzle (min. 90 psi)	4x blowing 4x brushing 4x blowing
1/2	-	9/16	9/16	6-3/4	08285		
-	#4	5/8	5/8	6-3/4	08275		
5/8	#5	11/16	11/16	7-7/8	08286		
		3/4	3/4	7-7/8	08278		
3/4	#6	7/8	7/8	7-7/8	08287	Compressed air nozzle only (min. 90 psi)	
7/8	#7	1	1	11-7/8	08288		
1	#8	1-1/8	1-1/8	11-7/8	08289		
		1-1/4	1-1/4	11-7/8	08274		
1-1/4	#9	1-3/8	1-3/8	11-7/8	08290		
-	#10	1-1/2	1-1/2	11-7/8	08291		

1. An SDS-plus adaptor (Cat. #08283) or Jacobs chuck style adaptor (Cat. #08296) is required to attach a steel wire brush to the drill tool.
2. For any case, it must be possible for the steel anchor element to be inserted into the cleaned hole without resistance.
3. A brush extension (Cat. #08282) must be used with a steel wire brush for holes drilled deeper than the listed brush length.

Piston Plugs for Adhesive Anchors^{1,2}

Plug Size (inch)	ANSI Drill Bit Diameter (inch)	Plastic Plug (Cat. #)	Piston Plug
11/16	11/16	08258	
3/4	3/4	08259	
7/8	7/8	08300	
1	1	08301	
1-1/8	1-1/8	08303	
1-1/4	1-1/4	08307	
1-3/8	1-3/8	08305	
1-1/2	1-1/2	08309	

1. Overhead and horizontal installations require the use of piston plugs where one is tabulated together with the anchor size.
2. A plastic extension tube (Cat. #08281 or Cat. #08297) or equivalent approved by DEWALT must be used with piston plugs.

ORDERING INFORMATION

ADHESIVES

PE1000+ Cartridge System

Cat No.	Description	Std. Ctn.	Pallet
0500SD	PE1000+ 13 fl. oz. dual cartridge	12	540
0502SD	PE1000+ 19.5 fl. oz. dual cartridge	12	540

One PE1000+ mixing nozzle is packaged with each cartridge.
PE1000+ mixing nozzles must be used to ensure complete and proper mixing of the adhesive.



Extra Mixing Nozzles

Cat No.	Description	Std. Ctn.	Pallet
08294	Extra mixing nozzle (with an 8" extension) for PE1000+	2	24
08281	Mixing nozzle extension, 8" long	2	24
08297	Mixing nozzle extension, 20" long	1	12



Dispensing Tools for Injection Adhesive

Cat No.	Description	Std. Ctn.	Std. Carton
08298	13 fl. oz. and 19.5 fl. oz. Manual Tool	1	6
08497SD	19.5 fl. oz. Pneumatic tool	1	-
DCE593D1	13 fl. oz. and 19.5 fl. oz. 20 v Battery powered dispensing tool	1	-



Hole Cleaning Tools and Accessories

Cat No.	Description	Std. Box
08284	Wire brush for 7/16" or 1/2" ANSI hole, 6-3/4" length	1
08285	Wire brush for 9/16" ANSI hole, 6-3/4" length	1
08275	Wire brush for 5/8" ANSI hole, 6-3/4" length	1
08286	Wire brush for 11/16" ANSI hole, 7-7/8" length	1
08278	Wire brush for 3/4" ANSI hole, 7-7/8" length	1
08287	Wire brush for 7/8" ANSI hole, 7-7/8" length	1
08288	Wire brush for 1" ANSI hole, 11-7/8" length	1
08289	Wire brush for 1-1/8" ANSI hole, 11-7/8" length	1
08274	Wire brush for 1-1/4" ANSI hole, 11-7/8" length	1
08290	Wire brush for 1-3/8" ANSI hole, 11-7/8" length	1
08291	Wire brush for 1-1/2" ANSI hole, 11-7/8" length	1
08283	SDS-plus adapter for steel brushes	1
08296	Standard drill adapter for steel brushes (e.g. Jacobs Chuck)	1
08282	Steel brush extension, 12" length	1
08280	Hand pump/dust blower (25 fl. oz. cylinder volume)	1
08292	Air compressor nozzle with extension, 18" length	1
52073	Adhesive cleaning kit, includes 4 wire brushes (08284, 08285, 08286, 08287), steel brush extension (08282), SDS-plus adapter (08283), standard drill adapter (08296), hand pump/dust blower (08280), gloves and safety glasses	1



Adhesive Piston Plugs

Cat No.	Description	ANSI Drill Bit Dia.	Std. Bag
08258	11/16" Plug	11/16"	10
08259	3/4" Plug	3/4"	10
08300	7/8" Plug	7/8"	10
08301	1" Plug	1"	10
08303	1-1/8" Plug	1-1/8"	10
08307	1-1/4" Plug	1-1/4"	10
08305	1-3/8" Plug	1-3/8"	10
08309	1-1/2" Plug	1-1/2"	10



PE1000+[®]
Epoxy Injection Adhesive Anchoring System