

GENERAL INFORMATION

PURE110+®

Epoxy Injection Adhesive Anchoring System
and Post-Installed Reinforcing Bar Connections

PRODUCT DESCRIPTION

The Pure110+ is a two-component, high strength adhesive anchoring system. The system includes injection adhesive in plastic cartridges, mixing nozzles, dispensing tools and hole cleaning equipment. The Pure110+ is designed for bonding threaded rod and reinforcing bar hardware into drilled holes in concrete and masonry base materials and for post-installed reinforcing bar connections.

GENERAL APPLICATIONS AND USES

- Bonding threaded rod and reinforcing bar into hardened concrete
- Rebar development length connections in concrete
- Evaluated for installation and use in dry and wet holes, including water filled and submerged
- Can be installed in a broad range of base material temperatures with good working times
- Cracked and uncracked concrete
- Seismic and wind loading
- Oversized hammer-drilled holes in concrete, for short term loading only (see www.DEWALT.com)

FEATURES AND BENEFITS

- + Designed for use with threaded rod and reinforcing bar hardware elements
- + Evaluated and recognized for freeze/thaw performance
- + Cartridge design allows for multiple uses using extra mixing nozzles
- + Mixing nozzles proportion adhesive and provide simple delivery method into drilled holes
- + Evaluated and recognized for long term and short term loading (see performance tables)
- + Same bond strength at room temperature and at 110°F

APPROVALS AND LISTINGS

- International Code Council, Evaluation Service (ICC-ES) ESR-3298 for cracked and uncracked concrete
- Code Compliant with 2018 IBC/IRC, 2015 IBC/IRC, 2012 IBC/IRC, 2009 IBC/IRC
- Conforms to requirements of ASTM C 881 and AASHTO M235, Types I, II, IV and V, Grade 3, Classes B & C (also meets Type III except for elongation)
- Department of Transportation listings – see www.DEWALT.com or contact transportation agency
- Tested in accordance with ACI 355.4, ASTM E 488, and ICC-ES AC308 for use in structural concrete (Design according to ACI 318-14, Chapter 17 and ACI 318-11/08 Appendix D)
- Tested and qualified for use in post-installed reinforcing bar connections
- Evaluated and qualified by an accredited independent testing laboratory for recognition in cracked and uncracked concrete including seismic and wind loading
- Compliant with NSF/ANSI/CAN 61 for drinking water system components - health effects; minimum requirements for materials in contact with potable water and water treatment

GUIDE SPECIFICATIONS

CSI Divisions: 03 16 00 - Concrete Anchors, 04 05 19.16 Masonry Anchors and 05 05 19 Post-Installed Concrete Anchors. Adhesive anchoring system shall be Pure110+ as supplied by DEWALT, Towson, MD. Anchors shall be installed in accordance with published instructions and requirements of the Authority Having Jurisdiction.



SECTION CONTENTS

General Information.....	1
Reference Data (ASD).....	2
Strength Design (SD).....	6
Installation Instructions for Adhesive Anchors (Solid Base Materials).....	18
Installation Instructions for Adhesive Anchors (Hollow Base Materials).....	20
Installation Instructions (Post-Installed rebar).....	21
Reference Installation Tables.....	23
Ordering Information.....	24



PACKAGING

Coaxial Cartridge

- 9 fl. oz. (265 ml or 16.2 in³)

Dual (side-by-side) Cartridge

- 20.5 fl. oz. (610 ml or 37.8 in³), 1:1 mix ratio
- 50.5 fl. oz. (1500 ml or 92.1 in³), 1:1 mix ratio

STORAGE LIFE & CONDITIONS

Dual cartridge: Two years
Coaxial cartridge: Eighteen months
Store in a dry, dark environment with temperature ranging from 41°F to 86°F (5°C to 30°C)

ANCHOR SIZE RANGE (TYPICAL)

- 3/8" to 1-1/4" diameter threaded rod
- No. 3 to No. 11 reinforcing bar (rebar)

SUITABLE BASE MATERIALS

- Normal-weight concrete
- Lightweight concrete
- Grouted Concrete Masonry
- Hollow Concrete Masonry

PERMISSIBLE INSTALLATION CONDITIONS (ADHESIVE)

- Dry concrete
- Water-saturated concrete (wet)
- Water-filled holes (flooded)
- Underwater concrete (submerged)

REFERENCE DATA (ASD)

ADHESIVES

PURE110+®
Epoxy Injection Adhesive Anchoring System

Installation Table for Pure110+ (Solid Concrete Base Materials)

Dimension/Property	Notation	Units	Nominal Anchor Size									
			3/8	1/2	-	5/8	3/4	7/8	1	-	1-1/4	-
Threaded Rod	-	-	3/8	1/2	-	5/8	3/4	7/8	1	-	1-1/4	-
Reinforcing Bar	-	-	#3	-	#4	#5	#6	#7	#8	#9	-	#10
Nominal anchor diameter	d	in. (mm)	0.375 (9.5)	0.500 (12.7)		0.625 (15.9)	0.750 (19.1)	0.875 (22.5)	1.000 (25.4)	1.125 (28.6)	1.250 (31.8)	1.250 (31.8)
Carbide drill bit nominal size ³	d _{bit}	in.	7/16 ANSI	9/16 ANSI	5/8 ANSI	11/16 or 3/4 ANSI	7/8 ANSI	1 ANSI	1-1/8 ANSI	1-3/8 ANSI	1-3/8 ANSI	1-1/2 ANSI
Minimum embedment	h _{nom}	in. (mm)	2-3/8 (61)	2-3/4 (70)		3-1/8 (80)	3-1/2 (89)	3-1/2 (89)	4 (102)	4-1/2 (114)	5 (127)	5 (127)
Minimum spacing distance	s _{min}	in. (mm)	1-7/8 (48)	2-1/2 (62)		3-1/8 (80)	3-3/4 (95)	4-3/8 (111)	5 (127)	5-5/8 (143)	6-1/4 (159)	6-1/4 (159)
Minimum edge distance	c _{min}	in. (mm)	1-7/8 (48)	2-1/2 (62)		3-1/8 (80)	3-3/4 (95)	4-3/8 (111)	5 (127)	5-5/8 (143)	6-1/4 (159)	6-1/4 (159)
Maximum torque ¹	T _{max}	ft.-lb. (N-m)	15 (20)	30 (41)	60 (81)	105 (142)	125 (169)	165 (223)	200 (270)	280 (379)	280 (379)	280 (379)
Maximum torque (low strength rods) ^{1,2}		ft.-lb. (N-m)	5 (7)	20 (27)	40 (54)	60 (81)	100 (136)	165 (223)	-	280 (379)	-	-

1. Torque may not be applied to the anchors until the full cure time of the adhesive has been achieved.
2. These torque values apply to ASTM A 36 / F 1554, Grade 36 carbon steel threaded rods; ASTM F1554 Grade 55 carbon steel threaded rods; and ASTM A193 Grade B8/B8M (Class 1) stainless steel threaded rods.
3. For any case, it must be possible for the steel anchor element to be inserted into the cleaned drilled hole without resistance.

Installation Table for Pure110+ (Hollow Base Material with Screen Tube)

Dimensions/property	Notation	Units	Nominal Size - Plastic			
			3/8"	1/2"	5/8"	3/4"
Nominal threaded rod diameter	d	in (mm)	0.375 (9.5)	0.500 (12.7)	0.625 (15.9)	0.750 (19.0)
Nominal screen tube diameter	-	in.	3/8	1/2	5/8	3/4
Nominal diameter of drilled hole	d _{bit}	in.	9/16 ANSI	3/4 ANSI	7/8 ANSI	1 ANSI
Maximum torque (only possible after full cure time of adhesive)	T _{max}	ft.-lb. (N-m)	10 (8)	10 (8)	10 (8)	10 (8)

Detail of Steel Hardware Elements used with Injection Adhesive System

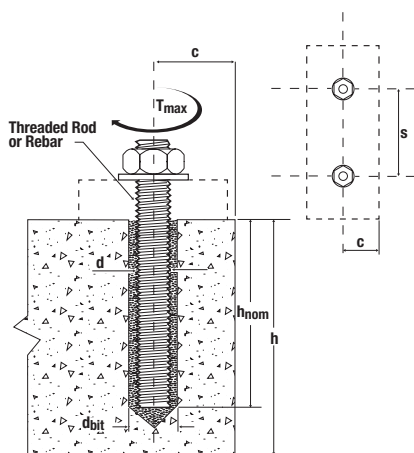

Nomenclature

- d = Diameter of anchor
- d_{bit} = Diameter of drilled hole
- h = Base material thickness
- The greater of:
[h_{nom} + 1-1/4"] and [h_{nom} + 2d_{bit}]
- h_{nom} = Minimum embedment depth

Threaded Rod and Deformed Reinforcing Bar Material Properties

Steel Description (General)	Steel Specification (ASTM)	Nominal Anchor Size (inch)	Minimum Yield Strength, f _y (ksi)	Minimum Ultimate Strength, f _u (ksi)
Carbon Steel	A 36 or F1554 Grade 36	3/8 through 1-1/4	36.0	58.0
	F 1554 Grade 55		55.0	75.0
	A 449	3/8 through 1	92.0	120.0
		1-1/4	81.0	105.0
	A 193, Grade B7 or F 1554, Grade 105	3/8 through 1-1/4	105.0	125.0
F 568M Class 5.8	3/4 through 1-1/4	58.0	72.5	
Stainless Steel	F 593, Condition CW	3/8 through 5/8	65.0	100.0
		3/4 through 1-1/4	45.0	85.0
	A 193/A193M Grade B8/B8M2, Class 1	3/4 through 1-1/4	30.0	75.0
A 193/A193M Grade B8/B8M2, Class 2B	3/8 through 1-1/4	75.0	95.0	
Grade 40 Reinforcing Bar	A 615, A 767	3/8 through 3/4 (#3 through #6)	40.0	60.0
Grade 60 Reinforcing Bar	A 615, A 767	3/8 through 1-1/4 (#3 through #10)	60.0	90.0
	A 706, A 767		60.0	80.0
Grade 75 Reinforcing Bar	A 615, A 767	3/8 through 1-1/4 (#3 through #10)	75.0	100.0

Ultimate and Allowable Load Capacities for Pure110+ Installed with Threaded Rod into Normal Weight Concrete (based on bond strength/concrete capacity)^{1,2,3,4,5,6,7}



Rod Diameter d in.	Drill Diameter d _{bit} in.	Minimum Embedment Depth in. (mm)	Minimum Concrete Compressive Strength			
			f'c = 3,000 psi (20.7 MPa)		f'c = 4,000 psi (27.6 MPa)	
			Ultimate Tension Load Capacity lbs. (kN)	Allowable Tension Load Capacity lbs. (kN)	Ultimate Tension Load Capacity lbs. (kN)	Allowable Tension Load Capacity lbs. (kN)
3/8	7/16	3-3/8 (85.7)	10,445 (46.5)	2,610 (11.6)	10,445 (46.5)	2,610 (11.6)
1/2	9/16	4 1/2 (114.3)	17,470 (77.7)	4,370 (19.4)	20,225 (90.0)	5,055 (22.5)
5/8	11/16 or 3/4	5-5/8 (142.9)	23,335 (103.8)	5,835 (26.0)	28,600 (127.2)	7,150 (31.8)
3/4	7/8	6-3/4 (171.5)	36,255 (161.3)	9,065 (40.3)	40,930 (182.1)	10,235 (45.5)
7/8	1	7-7/8 (200.0)	46,275 (205.8)	11,570 (51.5)	52,920 (235.4)	13,230 (58.8)
1	1-1/8	9 (228.6)	57,015 (253.6)	14,255 (63.4)	79,295 (352.7)	19,825 (88.2)
		10 (254.0)	77,445 (344.5)	19,360 (86.1)	82,745 (368.1)	20,685 (92.0)
1-1/4	1-3/8	11-1/4 (285.8)	91,885 (408.7)	22,970 (102.2)	98,170 (436.7)	24,545 (109.2)

1. Allowable load capacities listed are calculated using an applied safety factor of 4.0. Consideration of safety factors of 10 or higher may be necessary depending on the application, such as life safety or overhead.
2. Linear interpolation may be used to determine allowable loads for intermediate embedments and compressive strengths.
3. The tabulated load values are applicable to single anchors installed at critical edge and spacing distances and where the minimum member thickness is the greater of [h_{nom} + 1-1/4"] and [h_{nom} + 2d_{bit}].
4. The tabulated load values are applicable for dry concrete. Holes must be drilled with a hammer drill and an ANSI carbide drill bit. Installations in water-saturated concrete (wet) or in water-filled holes (flooded) require a 15% reduction in capacity. Installations in underwater concrete (submerged) require a 30% reduction in capacity. Contact DEWALT for more information concerning these installation conditions.
5. Adhesives experience reductions in capacity at elevated temperatures. See the in-service temperature chart for allowable load capacity reduction factors.
6. Allowable bond strength/concrete capacity must be checked against allowable steel strength in tension to determine the controlling allowable load.
7. Allowable shear capacity is controlled by allowable steel strength for the given conditions.

Ultimate and Allowable Load Capacities for Pure110+ Installed with Reinforcing Bar into Normal Weight Concrete (based on bond strength/concrete capacity)^{1,2,3,4,5,6,7}



Bar Diameter d #	Drill Diameter d _{bit} in.	Minimum Embedment Depth in. (mm)	Minimum Concrete Compressive Strength			
			f'c = 3,000 psi (20.7 MPa)		f'c = 4,000 psi (27.6 MPa)	
			Ultimate Tension Load Capacity lbs. (kN)	Allowable Tension Load Capacity lbs. (kN)	Ultimate Tension Load Capacity lbs. (kN)	Allowable Tension Load Capacity lbs. (kN)
#3	7/16	3-3/8 (85.7)	11,155 (49.6)	2,790 (12.4)	11,155 (49.6)	2,790 (12.4)
#4	9/16	4-1/2 (114.3)	17,735 (78.9)	4,435 (19.7)	19,200 (85.4)	4,800 (21.4)
#5	11/16 or 3/4	4 (101.6)	16,740 (74.5)	4,185 (18.6)	16,910 (75.2)	4,230 (18.8)
		5-5/8 (142.9)	23,420 (104.2)	5,855 (26.0)	25,705 (114.3)	6,425 (28.6)
#6	7/8	6-3/4 (171.5)	34,266 (152.4)	8,565 (38.1)	40,775 (181.4)	10,195 (45.3)
#8	1-1/8	9 (228.6)	55,140 (245.3)	13,785 (61.3)	72,575 (322.8)	18,145 (80.7)

1. Allowable load capacities listed are calculated using an applied safety factor of 4.0. Consideration of safety factors of 10 or higher may be necessary depending on the application, such as life safety or overhead.
2. Linear interpolation may be used to determine allowable loads for intermediate embedments and compressive strengths.
3. The tabulated load values are applicable to single anchors installed at critical edge and spacing distances and where the minimum member thickness is The greater of [h_{nom} + 1-1/4"] and [h_{nom} + 2d_{bit}].
4. The tabulated load values are applicable for dry concrete. Holes must be drilled with a hammer drill and an ANSI carbide drill bit. Installations in water-saturated concrete (wet) or in water-filled holes (flooded) require a 15% reduction in capacity. Installations in underwater concrete (submerged) require a 30% reduction in capacity. Contact DEWALT for more information concerning these installation conditions.
5. Adhesives experience reductions in capacity at elevated temperatures. See the in-service temperature chart for allowable load capacity reduction factors.
6. Allowable bond strength/concrete capacity must be checked against allowable steel strength in tension to determine the controlling allowable load.
7. Allowable shear capacity is controlled by allowable steel strength for the given conditions.



Allowable Load Capacities for Threaded Rod and Reinforcing Bar (Based on Steel Strength)^{1,2,3,4,5}

Nominal Rod Diameter or Rebar Size (in. or #)	Steel Elements - Threaded Rod and Reinforcing Bar																	
	A36 or F1554, Grade 36		A36 or F1554, Grade 55		A 193, Grade B7 or F1554, Grade 105		F 593, CW (SS)		ASTM A615 Grade 40 Rebar		ASTM A615 Grade 60 Rebar		ASTM A706 Grade 60 Rebar		ASTM A615 Grade 75 Rebar		ASTM A706 Grade 80 Rebar	
	Tension lbs. (kN)	Shear lbs. (kN)	Tension lbs. (kN)	Shear lbs. (kN)	Tension lbs. (kN)	Shear lbs. (kN)	Tension lbs. (kN)	Shear lbs. (kN)	Tension lbs. (kN)	Shear lbs. (kN)	Tension lbs. (kN)	Shear lbs. (kN)	Tension lbs. (kN)	Shear lbs. (kN)	Tension lbs. (kN)	Shear lbs. (kN)	Tension lbs. (kN)	Shear lbs. (kN)
3/8 or #3	2,115 (9.4)	1,090 (4.8)	2,735 (12.2)	1,410 (6.3)	4,555 (20.3)	2,345 (10.4)	3,645 (16.2)	1,880 (8.4)	2,210 (9.8)	1,125 (5.0)	2,650 (11.8)	1,690 (7.5)	2,650 (11.8)	1,500 (6.7)	2,650 (11.8)	1,875 (8.3)	2,650 (11.8)	1,875 (8.3)
1/2 or #4	3,760 (16.7)	1,935 (8.6)	4,860 (21.6)	2,505 (11.1)	8,100 (36.0)	4,170 (18.5)	6,480 (28.8)	3,340 (14.9)	3,925 (17.5)	2,005 (8.9)	4,710 (21.0)	3,005 (13.4)	4,710 (21.0)	2,670 (11.9)	4,710 (21.0)	3,335 (14.8)	4,710 (21.0)	3,335 (14.8)
5/8 or #5	5,870 (26.1)	3,025 (13.5)	7,595 (33.8)	3,910 (17.4)	12,655 (56.3)	6,520 (29.0)	10,125 (45.0)	5,215 (23.2)	6,135 (27.3)	3,130 (13.9)	7,365 (32.8)	4,695 (20.9)	7,365 (32.8)	4,170 (18.5)	7,365 (32.8)	5,215 (23.2)	7,365 (32.8)	5,215 (23.2)
3/4 or #6	8,455 (37.6)	4,355 (19.4)	10,935 (48.6)	5,635 (25.1)	18,225 (81.1)	9,390 (41.8)	12,390 (55.1)	6,385 (28.4)	8,835 (39.3)	4,505 (20.0)	10,605 (47.2)	6,760 (30.1)	10,605 (47.2)	6,010 (26.7)	10,605 (47.2)	7,510 (33.4)	10,605 (47.2)	7,510 (33.4)
7/8 or #7	11,510 (51.2)	5,930 (26.4)	14,885 (66.2)	7,665 (34.1)	24,805 (110.3)	12,780 (56.8)	16,865 (75.0)	8,690 (38.7)	-	-	14,430 (64.2)	9,200 (40.9)	14,430 (64.2)	8,180 (36.4)	14,430 (64.2)	10,220 (45.5)	14,430 (64.2)	10,220 (45.5)
1 or #8	15,035 (66.9)	7,745 (34.5)	19,440 (86.5)	10,015 (44.5)	32,400 (144.1)	16,690 (74.2)	22,030 (98.0)	11,350 (50.5)	-	-	18,850 (83.8)	12,015 (53.4)	18,850 (83.8)	10,680 (47.5)	18,850 (83.8)	13,350 (59.4)	18,850 (83.8)	13,350 (59.4)
#9	-	-	-	-	-	-	-	-	-	-	23,985 (106.7)	15,290 (68.0)	23,985 (106.7)	13,590 (60.5)	23,985 (106.7)	16,990 (75.6)	23,985 (106.7)	16,990 (75.6)
1-1/4	23,490 (104.5)	12,100 (53.8)	30,375 (135.1)	15,645 (69.6)	50,620 (225.2)	26,080 (116.0)	34,425 (153.1)	17,735 (78.9)	-	-	-	-	-	-	-	-	-	-
#10	-	-	-	-	-	-	-	-	-	-	30,405 (135.2)	19,380 (86.2)	30,405 (135.2)	17,230 (76.6)	30,405 (135.2)	21,535 (95.8)	30,405 (135.2)	21,535 (95.8)

1. AISC defined steel strength (ASD) for threaded rod: Tensile = $0.33 \cdot F_u \cdot A_{nom}$, Shear = $0.17 \cdot F_u \cdot A_{nom}$
2. For reinforcing bars: The allowable steel tensile strength is based on 20 ksi for Grade 40 and 24 ksi for Grade 60 and higher, applied to the cross sectional area of the bar; allowable steel shear strength = $0.17 \cdot F_u \cdot A_{nom}$
3. Allowable load capacities are calculated for the steel element type. Consideration of applying additional safety factors may be necessary depending on the application, such as life safety or overhead.
4. Allowable steel strength in tension must be checked against allowable bond strength/concrete capacity in tension to determine the controlling allowable load.
5. The tabulated load values are applicable to single anchors installed at critical edge and spacing distances and where the minimum member thickness is the greater of $[7t_{nom} + 1-1/4"]$ and $[7t_{nom} + 2d_{bar}]$

In-Service Temperature Chart For Allowable Load Capacities

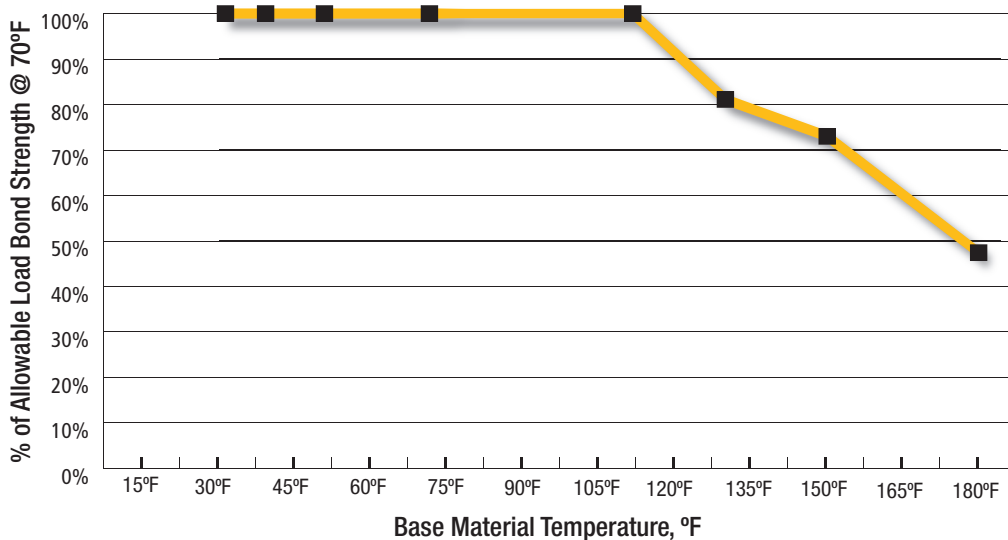

Ultimate and Allowable Load Capacities for Threaded Rod Installed with Pure110+ into Grout-Filled Masonry^{1,2,3,4,5,7}



Anchor Installed into Grouted Masonry Wall Faces								
Nominal Diameter d in.	Minimum Embed. h _v in. (mm)	Nominal Drill Bit Diameter in.	Minimum End Distance in. (mm)	Minimum Edge Distance in. (mm)	Ultimate Load		Allowable Load	
					Tension lbs. (kN)	Shear lbs. (kN)	Tension lbs. (kN)	Shear lbs. (kN)
3/8	3 (76.2)	7/16 ANSI	12 (304.8)	12 (304.8)	6,005 (26.7)	5,200 (23.1)	1,200 (5.3)	1,040 (4.6)
1/2	4 (101.6)	9/16 ANSI	12 (304.8)	12 (304.8)	8,650 (38.5)	8,845 (39.3)	1,730 (7.7)	1,770 (7.9)
5/8	5 (127)	11/16 ANSI	12 (304.8)	12 (304.8)	12,840 (57.1)	8,430 (37.5)	2,570 (11.4)	1,685 (7.5)
3/4	6 (152.4)	7/8 ANSI	20 (508)	20 (508)	19,560 (87.0)	12,685 (56.4)	3,910 (17.4)	2,540 (11.3)

Anchor Installed in the Tops of Grouted Masonry Walls ⁶								
Nominal Diameter d in.	Minimum Embed. h _v in. (mm)	Nominal Drill Bit Diameter in.	Minimum End Distance in. (mm)	Minimum Edge Distance in. (mm)	Ultimate Load		Allowable Load	
					Tension lbs. (kN)	Shear lbs. (kN)	Tension lbs. (kN)	Shear lbs. (kN)
1/2	4 (101.6)	9/16 ANSI	4 (101.6)	1.75 (44.5)	5,135 (22.8)	1,750 (7.8)	1,030 (4.6)	350 (1.6)
5/8	5 (127)	11/16 ANSI	4 (101.6)	2.75 (69.9)	5,360 (23.6)	3,130 (13.9)	1,070 (4.8)	625 (2.8)

1. Tabulated load values are for 3/8" and 1/2" diameter anchors installed in minimum 6" wide, Grade N, Type II, light weight concrete masonry units conforming to ASTM C 90 that have reached the minimum designated ultimate compressive strength at the time of installation (f_m ≥ 1,500 psi).
2. Tabulated load values are for 5/8" and 3/4" diameter anchors installed in 8" wide, Grade N, Type II, light weight concrete masonry units conforming to ASTM C 90 that have reached the minimum designated ultimate compressive strength at the time of installation (f_m ≥ 1,500 psi).
3. Anchors must be installed in grouted cells and the minimum edge and end distances must be maintained.
4. Allowable load capacities listed are calculated using an applied safety factor of 5.0 and must be checked against the allowable tension and shear capacities for threaded rod based on steel strength to determine the controlling factor.
5. The tabulated values are applicable for anchors installed into grouted masonry wall faces and masonry wall tops at a critical spacing distance, s_{cr}, between anchors of 3 times the embedment depth.
6. Anchor installations into tops of grouted masonry walls are limited to one per masonry cell.
7. The tabulated values must be adjusted for increased in-service base material temperatures in accordance with the In-Service Temperature chart, as applicable.

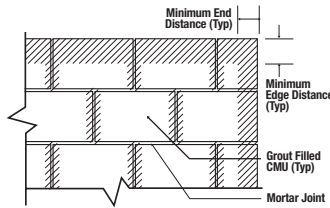

Wall Face
Permissible Anchor Locations
(Un-hatched Area)

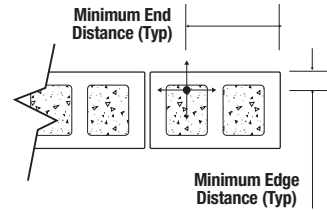

Top of Wall

Ultimate and Allowable Load Capacities for Threaded Rod Installed with Pure110+ into Hollow Concrete Masonry Walls with Plastic Screen Tubes^{1,2,3,4,5}



Nominal Anchor Diameter in.	Minimum Screen Tube Length in.	Minimum End Distance in. (mm)	Minimum Edge Distance in. (mm)	ASTM C-90 Block Type	Ultimate Load	Allowable Load
					Tension lbs. (kN)	Tension lbs. (kN)
3/8	3-1/2	3-3/4 (95.3)	3-3/4 (95.3)	Lightweight	790 (3.5)	160 (0.7)
1/2	3-1/2	3-3/4 (95.3)	3-3/4 (95.3)	Lightweight	1,255 (5.6)	250 (1.1)
5/8	6	3-3/4 (95.3)	3-3/4 (95.3)	Normal-weight*	1,545 (6.9)	310 (1.4)
3/4	6	3-3/4 (95.3)	3-3/4 (95.3)	Normal-weight*	1,545 (6.9)	310 (1.4)

1. Tabulated load values are for anchors installed in minimum 8" wide, Grade N, Type II, lightweight or normal weight concrete masonry units conforming to ASTM C 90 that have reached a designated ultimate compressive strength at the time of installation (f_m ≥ 1,500 psi). Mortar must be type N, S or M.
2. Allowable loads are calculated using an applied safety factor of 5.0. Consideration of safety factors of 10 or higher may be necessary depending on the application, such as life safety.
3. Anchor spacing is limited to one per masonry cell.
4. The tabulated load values are applicable to normal-weight concrete masonry units with a minimum face shell thickness of 1-1/2 inches.
5. The tabulated values must be adjusted for increased in-service base material temperatures in accordance with the In-Service Temperature chart, as applicable.

STRENGTH DESIGN (SD)

Installation Specifications for Threaded Rod and Reinforcing Bar¹

CODE LISTED
ICC-ES ESR-3298



Parameter	Symbol	Units	Fractional Nominal Rod Diameter (Inch) / Reinforcing Bar Size									
			3/8 or #3	1/2	#4	5/8 or #5	3/4 or #6	7/8 or #7	1 or #8	#9	1-1/4	#10
Threaded rod outside diameter	d	inch (mm)	0.375 (9.5)	0.500 (12.7)	0.625 (15.9)	0.750 (19.1)	0.875 (22.2)	1.000 (25.4)	-	1.250 (31.8)	-	
Rebar nominal outside diameter	d	inch (mm)	0.375 (9.5)	0.500 (12.7)	0.625 (15.9)	0.750 (19.1)	0.875 (22.2)	1.000 (25.4)	1.125 (28.7)	-	1.250 (31.8)	
Carbide drill bit nominal size ⁶	d _o (d _{bit})	inch	7/16	9/16	5/8	11/16 or 3/4	7/8	1	1-1/8	1-3/8	1-3/8	1-1/2
Minimum embedment	h _{ef,min}	inch (mm)	2-3/8 (60)	2-3/4 (70)	3-1/8 (79)	3-1/2 (89)	3-1/2 (89)	4 (102)	4-1/2 (114)	5 (127)	5 (127)	
Maximum embedment	h _{ef,max}	inch (mm)	7-1/2 (191)	10 (254)	12-1/2 (318)	15 (381)	17-1/2 (445)	20 (508)	22-1/2 (572)	25 (635)	25 (635)	
Minimum member thickness	h _{min}	inch (mm)	h _{ef} + 1-1/4 (h _{ef} + 30)			h _{ef} + 2d _o						
Minimum anchor spacing	s _{min}	inch (mm)	1-7/8 (48)	2-1/2 (64)	3-1/8 (79)	3-3/4 (95)	4-3/8 (111)	5 (127)	5-5/8 (143)	6-1/4 (159)	6-1/4 (159)	
Minimum edge distance	c _{min}	inch (mm)	1-7/8 (48)	2-1/2 (64)	3-1/8 (79)	3-3/4 (95)	4-3/8 (111)	5 (127)	5-5/8 (143)	6-1/4 (159)	6-1/4 (159)	
Max. torque ²	T _{max}	ft-lbs (N-m)	15 (20)	30 (41)	60 (81)	105 (142)	125 (169)	165 (221)	200 (280)	280 (379)	280 (379)	
Max. torque ^{2,3} (low strength rods)	T _{max}	ft-lbs (N-m)	5 (7)	20 (27)	40 (54)	60 (81)	100 (136)	165 (223)	-	280 (379)	-	
Minimum edge distance, reduced ⁵	c _{min,red}	inch (mm)	1-3/4 (45)	1-3/4 (45)	1-3/4 (45)	1-3/4 (45)	1-3/4 (45)	1-3/4 (45)	2-3/4 (70)	2-3/4 (70)	2-3/4 (70)	
Max. torque, reduced ²	T _{max,red}	ft-lbs (N-m)	7 [5]*	14 (19)	27 (37)	47 (64)	56 (76)	74 (100)	90 (122)	126 (171)	126 (171)	

- For pound-inch units: 1 mm = 0.03937 inch, 1 N-m = 0.7375 ft-lbf. For SI: 1 inch = 25.4 mm, 1 ft-lbf = 1.356 N-m.
- For use with the design provisions of ACI 318-14 Ch.17 or ACI 318-11 Appendix D as applicable, ICC-ES AC308, Section 4.2 and ESR-3298
 - Torque may not be applied to the anchors until the full cure time of the adhesive has been achieved.
 - These torque values apply to ASTM A 36 / F 1554 Grade 36 carbon steel threaded rods; ASTM F 1554 Grade 55 carbon steel threaded rods; and ASTM A 193 Grade B8/B8M (Class 1) stainless steel threaded rods.
 - These torque values apply to ASTM A 193 Grade B8/B8M (Class 1) stainless steel threaded rods.
 - For installation between the minimum edge distance, c_{min}, and the reduced minimum edge distance, c_{min,red}, the maximum torque applied must be max torque reduced, T_{max,red}.
 - For any case, it must be possible for the steel anchor element to be inserted into the cleaned drill hole without resistance.

Detail of Steel Hardware Elements used with Injection Adhesive System

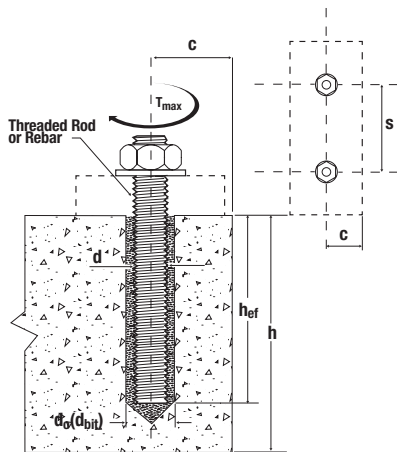

Threaded Rod and Deformed Reinforcing Bar Material Properties

Steel Description (General)	Steel Specification (ASTM)	Nominal Anchor Size (inch)	Minimum Yield Strength, f _y (ksi)	Minimum Ultimate Strength, f _u (ksi)
Carbon rod	A 36 or F 1554 Grade 36	3/8 through 1-1/4	36.0	58.0
	F 1554 Grade 55		55.0	75.0
	A 449	3/8 through 1	92.0	120.0
		1-1/4	81.0	105.0
	A 193, Grade B7 or F 1554, Grade 105	3/8 through 1-1/4	105.0	125.0
F 568M Class 5 8	3/4 through 1-1/4	58.0	72.5	
Stainless rod	F 593 Condition CW	3/8 through 5/8	65.0	100.0
		3/4 through 1-1/4	45.0	85.0
	A 193/A193M Grade B8/B8M, Class 1	3/8 through 1-1/4	30.0	75.0
A 193/A193M Grade B8/B8M2, Class 2B	3/8 through 1-1/4	75.0	95.0	
Grade 40 Reinforcing Bar	A 615, A 767	3/8 through 1-1/4 (#3 through #10)	40.0	60.0
Grade 60 Reinforcing Bar	A 615, A 767	3/8 through 1-1/4 (#3 through #10)	60.0	90.0
	A 706, A 767		60.0	80.0
Grade 75 Reinforcing Bar	A 615, A 767	3/8 through 1-1/4 (#3 through #10)	75.0	100.0

**Steel Tension and Shear Design for Threaded Rod in Normal Weight Concrete
(For use with load combinations taken from ACI 318-14 Section 5.3)**

CODE LISTED
ICC-ES ESR-3298



Design Information		Symbol	Units	Nominal Rod Diameter ¹ (inch)						
				3/8	1/2	5/8	3/4	7/8	1	1-1/4
Threaded rod nominal outside diameter		d	inch (mm)	0.375 (9.5)	0.500 (12.7)	0.625 (15.9)	0.750 (19.1)	0.875 (22.2)	1.000 (25.4)	1.250 (31.8)
Threaded rod effective cross-sectional area		A _{se}	inch ² (mm ²)	0.0775 (50)	0.1419 (92)	0.2260 (146)	0.3345 (216)	0.4617 (298)	0.6057 (391)	0.9691 (625)
ASTM A 36 and ASTM F 1554 Grade 36	Nominal strength as governed by steel strength (for a single anchor)	N _{sa}	lbf (kN)	4,495 (20.0)	8,230 (36.6)	13,110 (58.3)	19,400 (86.3)	26,780 (119.1)	35,130 (156.3)	56,210 (250.0)
		V _{sa}	lbf (kN)	2,695 (12.0)	4,940 (22.0)	7,860 (35.0)	11,640 (51.8)	16,070 (71.4)	21,080 (93.8)	33,725 (150.0)
	Reduction factor for seismic shear	α _{v,seis}	-	0.80	0.80	0.80	0.80	0.80	0.80	0.80
	Strength reduction factor for tension ²	φ	-	0.75						
Strength reduction factor for shear ²		φ	-	0.65						
ASTM F 1554 Grade 55	Nominal strength as governed by steel strength (for a single anchor)	N _{sa}	lbf (kN)	5,810 (25.9)	10,640 (47.3)	16,950 (75.4)	25,085 (111.6)	34,625 (154.0)	45,425 (202.0)	72,680 (323.3)
		V _{sa}	lbf (kN)	3,485 (15.5)	6,385 (28.4)	10,170 (45.2)	15,050 (67.0)	20,775 (92.4)	27,255 (121.2)	43,610 (194.0)
	Reduction factor for seismic shear	α _{v,seis}	-	0.80	0.80	0.80	0.80	0.80	0.80	0.80
	Strength reduction factor for tension ²	φ	-	0.75						
Strength reduction factor for shear ²		φ	-	0.65						
ASTM A 193 Grade B7 and ASTM F 1554 Grade 105	Nominal strength as governed by steel strength (for a single anchor)	N _{sa}	lbf (kN)	9,685 (43.1)	17,735 (78.9)	28,250 (125.7)	41,810 (186.0)	57,710 (256.7)	75,710 (336.8)	121,135 (538.8)
		V _{sa}	lbf (kN)	5,815 (25.9)	10,640 (47.3)	16,950 (75.4)	25,085 (111.6)	34,625 (154.0)	45,425 (202.1)	72,680 (323.3)
	Reduction factor for seismic shear	α _{v,seis}	-	0.80	0.80	0.80	0.80	0.80	0.80	0.80
	Strength reduction factor for tension ²	φ	-	0.75						
Strength reduction factor for shear ²		φ	-	0.65						
ASTM A 449	Nominal strength as governed by steel strength (for a single anchor)	N _{sa}	lbf (kN)	9,300 (41.4)	17,025 (75.7)	27,120 (120.6)	40,140 (178.5)	55,905 (248.7)	72,685 (323.3)	101,755 (452.6)
		V _{sa}	lbf (kN)	5,580 (24.8)	10,215 (45.4)	16,270 (72.4)	24,085 (107.1)	33,540 (149.2)	43,610 (194.0)	61,050 (271.6)
	Reduction factor for seismic shear	α _{v,seis}	-	0.80	0.80	0.80	0.80	0.80	0.80	0.80
	Strength reduction factor for tension ²	φ	-	0.75						
Strength reduction factor for shear ²		φ	-	0.65						
ISO 898-1 Class 5.8	Nominal strength as governed by steel strength (for a single anchor)	N _{sa}	lbf (kN)	5,620 (25.0)	10,290 (45.8)	16,385 (72.9)	24,250 (107.9)	33,475 (148.9)	43,915 (195.4)	- ⁵
		V _{sa}	lbf (kN)	3,370 (15.0)	6,175 (27.5)	9,830 (43.7)	14,550 (64.7)	20,085 (89.3)	26,350 (117.2)	- ⁵
	Reduction factor for seismic shear	α _{v,seis}	-	0.80	0.80	0.80	0.80	0.80	0.80	- ⁵
	Strength reduction factor for tension ³	φ	-	0.65						
Strength reduction factor for shear ³		φ	-	0.60						
ASTM F 593 CW Stainless (Types 304 and 316)	Nominal strength as governed by steel strength (for a single anchor)	N _{sa}	lbf (kN)	7,750 (34.5)	14,190 (63.1)	22,600 (100.5)	28,430 (126.5)	39,245 (174.6)	51,485 (229.0)	82,370 (366.4)
		V _{sa}	lbf (kN)	4,650 (20.7)	8,515 (37.9)	13,560 (60.3)	17,060 (75.9)	23,545 (104.7)	30,890 (137.4)	49,425 (219.8)
	Reduction factor for seismic shear	α _{v,seis}	-	0.70	0.70	0.80	0.80	0.80	0.80	0.80
	Strength reduction factor for tension ³	φ	-	0.65						
Strength reduction factor for shear ³		φ	-	0.60						
ASTM A 193 Grade B8/B8M, Class 1 Stainless (Types 304 and 316)	Nominal strength as governed by steel strength (for a single anchor) ⁴	N _{sa}	lbf (kN)	4,420 (19.7)	8,090 (36.0)	12,880 (57.3)	19,065 (84.8)	26,315 (117.1)	34,525 (153.6)	55,240 (245.7)
		V _{sa}	lbf (kN)	2,650 (11.8)	4,855 (21.6)	7,730 (34.4)	11,440 (50.9)	15,790 (70.2)	20,715 (92.1)	33,145 (147.4)
	Reduction factor for seismic shear	α _{v,seis}	-	0.70	0.70	0.80	0.80	0.80	0.80	0.80
	Strength reduction factor for tension ²	φ	-	0.75						
Strength reduction factor for shear ²		φ	-	0.65						
ASTM A 193 Grade B8/B8M2, Class 2B Stainless (Types 304 and 316)	Nominal strength as governed by steel strength (for a single anchor)	N _{sa}	lbf (kN)	7,365 (32.8)	13,480 (60.0)	21,470 (95.5)	31,775 (141.3)	43,860 (195.1)	57,545 (256.0)	92,065 (409.5)
		V _{sa}	lbf (kN)	4,420 (19.7)	8,085 (36.0)	12,880 (57.3)	19,065 (84.8)	26,315 (117.1)	34,525 (153.6)	55,240 (245.7)
	Reduction factor for seismic shear	α _{v,seis}	-	0.70	0.70	0.80	0.80	0.80	0.80	0.80
	Strength reduction factor for tension ²	φ	-	0.75						
Strength reduction factor for shear ²		φ	-	0.65						

For SI: 1 inch = 25.4 mm, 1 lbf = 4.448 N. For pound-inch units: 1 mm = 0.03937 inches, 1 N = 0.2248 lbf.

- Values provided for steel element material types are based on minimum specified strengths and calculated in accordance with ACI 318-14 Eq. 17.4.1.2 and Eq. 17.5.1.2b or ACI 318-11 Eq. (D-2) and Eq. (D-29), as applicable, except where noted. Nuts and washers must be appropriate for the rod. Nuts must have specified proof load stresses equal to or greater than the minimum tensile strength of the specified threaded rod.
- The tabulated value of φ applies when the load combinations of Section 1605.2 of the IBC, ACI 318-14 5.3 or ACI 318-11 9.2, as applicable, are used in accordance with ACI 318-14 17.3.3 or ACI 318-11 D.4.3, as applicable. If the load combinations of ACI 318-11 Appendix C are used, the appropriate value of φ must be determined in accordance with ACI 318 D.4.4. Values correspond to ductile steel elements.
- The tabulated value of φ applies when the load combinations of Section 1605.2 of the IBC, ACI 318-14 5.3 or ACI 318-11 9.2, as applicable, are used in accordance with ACI 318-14 17.3.3 or ACI 318-11 D.4.3, as applicable. If the load combinations of ACI 318-11 Appendix C are used, the appropriate value of φ must be determined in accordance with ACI 318 D.4.4. Values correspond to brittle steel elements.
- In accordance with AASHTO 318-14 17.4.1.2 and 17.5.1.2 or ACI 318-11 D.5.1.2 and D.6.1.2, as applicable, the calculated values for nominal tension and shear strength for ASTM A193 Grade B8/B8M Class 1 stainless steel threaded rods are based on limiting the specified tensile strength of the anchor steel to 1.9fy or 57,000 psi (393 MPa).
- The referenced standard includes rod diameters up to and including 1-inch (24 mm).

Steel Tension and Shear Design for Reinforcing Bars in Normal Weight Concrete
(For use with load combinations taken from ACI 318-14 Section 5.3)

CODE LISTED
ICC-ES ESR-3298



Design Information		Symbol	Units	Nominal Reinforcing Bar Size (Rebar)							
				No. 3	No. 4	No. 5	No. 6	No. 7	No. 8	No. 9	No. 10
Rebar nominal outside diameter		d	inch (mm)	0.375 (9.5)	0.500 (12.7)	0.625 (15.9)	0.750 (19.1)	0.875 (22.2)	1.000 (25.4)	1.125 (28.7)	1.250 (32.3)
Rebar effective cross-sectional area		A _{se}	inch ² (mm ²)	0.110 (71.0)	0.200 (129.0)	0.310 (200.0)	0.440 (283.9)	0.600 (387.1)	0.790 (509.7)	1.000 (645.2)	1.270 (819.4)
ASTM A 615 Grade 75	Nominal strength as governed by steel strength (for a single anchor)	N _{sa}	lbf (kN)	11,000 (48.9)	20,000 (89.0)	31,000 (137.9)	44,000 (195.7)	60,000 (266.9)	79,000 (351.4)	100,000 (444.8)	127,000 (564.9)
		V _{sa}	lbf (kN)	6,600 (29.4)	12,000 (53.4)	18,600 (82.7)	26,400 (117.4)	36,000 (160.1)	47,400 (210.8)	60,000 (266.9)	76,200 (338.9)
	Reduction factor for seismic shear	α _{v,seis}	-	0.70	0.70	0.80	0.80	0.80	0.80	0.80	0.80
	Strength reduction factor for tension ³	φ	-	0.65							
	Strength reduction factor for shear ³	φ	-	0.60							
ASTM A 615 Grade 60	Nominal strength as governed by steel strength (for a single anchor)	N _{sa}	lbf (kN)	9,900 (44.0)	18,000 (80.1)	27,900 (124.1)	39,600 (176.1)	54,000 (240.2)	71,100 (316.3)	90,000 (400.3)	114,300 (508.4)
		V _{sa}	lbf (kN)	5,940 (26.4)	10,800 (48.0)	16,740 (74.5)	23,760 (105.7)	32,400 (144.1)	42,660 (189.8)	54,000 (240.2)	68,580 (305.0)
	Reduction factor for seismic shear	α _{v,seis}	-	0.70	0.70	0.80	0.80	0.80	0.80	0.80	0.80
	Strength reduction factor for tension ²	φ	-	0.75							
	Strength reduction factor for shear ²	φ	-	0.65							
ASTM A 706 Grade 60	Nominal strength as governed by steel strength (for a single anchor)	N _{sa}	lbf (kN)	8,800 (39.1)	16,000 (71.2)	24,800 (110.3)	35,200 (156.6)	48,000 (213.5)	63,200 (281.1)	80,000 (355.9)	101,600 (452.0)
		V _{sa}	lbf (kN)	5,280 (23.5)	9,600 (42.7)	14,880 (66.2)	21,120 (94.0)	28,800 (128.1)	37,920 (168.7)	48,000 (213.5)	60,960 (271.2)
	Reduction factor for seismic shear	α _{v,seis}	-	0.70	0.70	0.80	0.80	0.80	0.80	0.80	0.80
	Strength reduction factor for tension ²	φ	-	0.75							
	Strength reduction factor for shear ²	φ	-	0.65							
ASTM A 615 Grade 40	Nominal strength as governed by steel strength (for a single anchor)	N _{sa}	lbf (kN)	6,600 (29.4)	12,000 (53.4)	18,600 (82.7)	26,400 (117.4)	In accordance with ASTM A 615, Grade 40 bars are furnished only in sizes No. 3 through No. 6			
		V _{sa}	lbf (kN)	3,960 (17.6)	7,200 (32.0)	11,160 (49.6)	15,840 (70.5)				
	Reduction factor for seismic shear	α _{v,seis}	-	0.70	0.70	0.80	0.80				
	Strength reduction factor for tension ²	φ	-	0.75							
	Strength reduction factor for shear ²	φ	-	0.65							

For Sl: 1 inch = 25.4 mm, 1 lbf = 4.448 N. For pound-inch units: 1 mm = 0.03937 inches, 1 N = 0.2248 lbf.

- Values provided for reinforcing bar material types based on minimum specified strengths and calculated in accordance with ACI 318-14 Eq. 17.4.1.2 and Eq. 17.5.1.2b or ACI 318-11 Eq. (D-2) and Eq. (D-29), as applicable.
- The tabulated value of φ applies when the load combinations of Section 1605.2 of the IBC, ACI 318-14 5.3 or ACI 318-11 9.2, as applicable, are used in accordance with ACI 318-14 17.3.3 or ACI 318-11 D.4.3, as applicable. If the load combinations of ACI 318-11 Appendix C are used, the appropriate value of φ must be determined in accordance with ACI 318 D.4.4. Values correspond to ductile steel elements. In accordance with ACI 318-14 17.2.3.4.3(a)(vi) or ACI 318-11 D.3.3.4.3(a)6, as applicable, deformed reinforcing bars meeting this specification used as ductile steel elements to resist earthquake effects shall be limited to reinforcing bars satisfying the requirements of ACI 318-14 20.2.2.4 and 20.2.2.5 or ACI 318-11 21.1.5.2 (a) and (b), as applicable.
- The tabulated value of φ applies when the load combinations of Section 1605.2 of the IBC, ACI 318-14 5.3 or ACI 318-11 9.2, as applicable, are used in accordance with ACI 318-14 17.3.3 or ACI 318-11 D.4.3, as applicable. If the load combinations of ACI 318-11 Appendix C are used, the appropriate value of φ must be determined in accordance with ACI 318 D.4.4. Values correspond to brittle steel elements.

ADHESIVES

PURE110+®
Epoxy Injection Adhesive Anchoring System

Concrete Breakout Design Information for Threaded Rod and Reinforcing Bars
(For use with loads combinations taken from ACI 318-14 Section 5.3)¹

CODE LISTED
ICC-ES ESR-3298



Design Information	Symbol	Units	Nominal Rod Diameter (inch) / Reinforcing Bar Size							
			3/8 or #3	1/2 or #4	5/8 or #5	3/4 or #6	7/8 or #7	1 or #8	#9	1-1/4 or #10
Effectiveness factor for cracked concrete	$k_{c,cr}$	- (SI)	17 (7.1)							
Effectiveness factor for uncracked concrete	$k_{c,uncr}$	- (SI)	24 (10.0)							
Minimum embedment	$h_{ef,min}$	inch (mm)	2-3/8 (60)	2-3/4 (70)	3-1/8 (79)	3-1/2 (89)	3-1/2 (89)	4 (102)	4-1/2 (114)	5 (127)
Maximum embedment	$h_{ef,max}$	inch (mm)	7-1/2 (191)	10 (254)	12-1/2 (318)	15 (381)	17-1/2 (445)	20 (508)	22-1/2 (572)	25 (635)
Minimum anchor spacing	s_{min}	inch (mm)	1-7/8 (48)	2-1/2 (64)	3-1/8 (79)	3-3/4 (95)	4-3/8 (111)	5 (127)	5-5/8 (143)	6-1/4 (159)
Minimum edge distance ²	c_{min}	inch (mm)	5d where d is nominal outside diameter of the anchor							
Minimum edge distance, reduced ²	$c_{min,red}$	inch (mm)	1-3/4 (45)	1-3/4 (45)	1-3/4 (45)	1-3/4 (45)	1-3/4 (45)	1-3/4 (45)	2-3/4 (70)	2-3/4 (70)
Minimum member thickness	h_{min}	inch (mm)	$h_{ef} + 1-1/4$ ($h_{ef} + 30$)		$h_{ef} + 2d_o$ where d_o is hole diameter;					
Critical edge distance—splitting (for uncracked concrete only) ³	c_{ac}	inch	$c_{ac} = h_{ef} \cdot \left(\frac{\tau_{k,uncr}}{1160}\right)^{0.4} \cdot [3.1 - 0.7 \frac{h}{h_{ef}}]$							
		(mm)	$c_{ac} = h_{ef} \cdot \left(\frac{\tau_{k,uncr}}{8}\right)^{0.4} \cdot [3.1 - 0.7 \frac{h}{h_{ef}}]$							
Strength reduction factor for tension, concrete failure modes, Condition B ⁴	ϕ	-	0.65							
Strength reduction factor for shear, concrete failure modes, Condition B ⁴	ϕ	-	0.70							

For SI: 1 inch = 25.4 mm, 1 lbf = 4.448 N. For pound-inch units: 1 mm = 0.03937 inch, 1 N = 0.2248 lbf.

- Additional setting information is described in the installation instructions.
- For installation between the minimum edge distance, c_{min} , and the reduced minimum edge distance, $c_{min,red}$, the maximum torque applied must be reduced (multiplied) by a factor of 0.45.
- $\tau_{k,uncr}$ need not be taken as greater than: $\tau_{k,uncr} = k_{uncr} \cdot \sqrt{h_{ef} \cdot f'_c}$ and $\frac{h}{h_{ef}}$ need not be taken as larger than 2.4.
- Condition A requires supplemental reinforcement, while Condition B applies where supplemental reinforcement is not provided or where pryout governs, as set forth in ACI 318-14 17.3.3 or ACI 318-11 D.4.3, as applicable. The tabulated value of ϕ applies when the load combinations of Section 1605.2 of the IBC, ACI 318-14 5.3 or ACI 318-11 9.2, as applicable, are used in accordance with ACI 318-14 17.3.3 or ACI 318-11 D.4.3, as applicable. If the load combinations of ACI 318-11 Appendix C are used, the appropriate value of ϕ must be determined in accordance with ACI 318 D.4.4.

FLOWCHART FOR THE ESTABLISHMENT OF DESIGN BOND STRENGTH

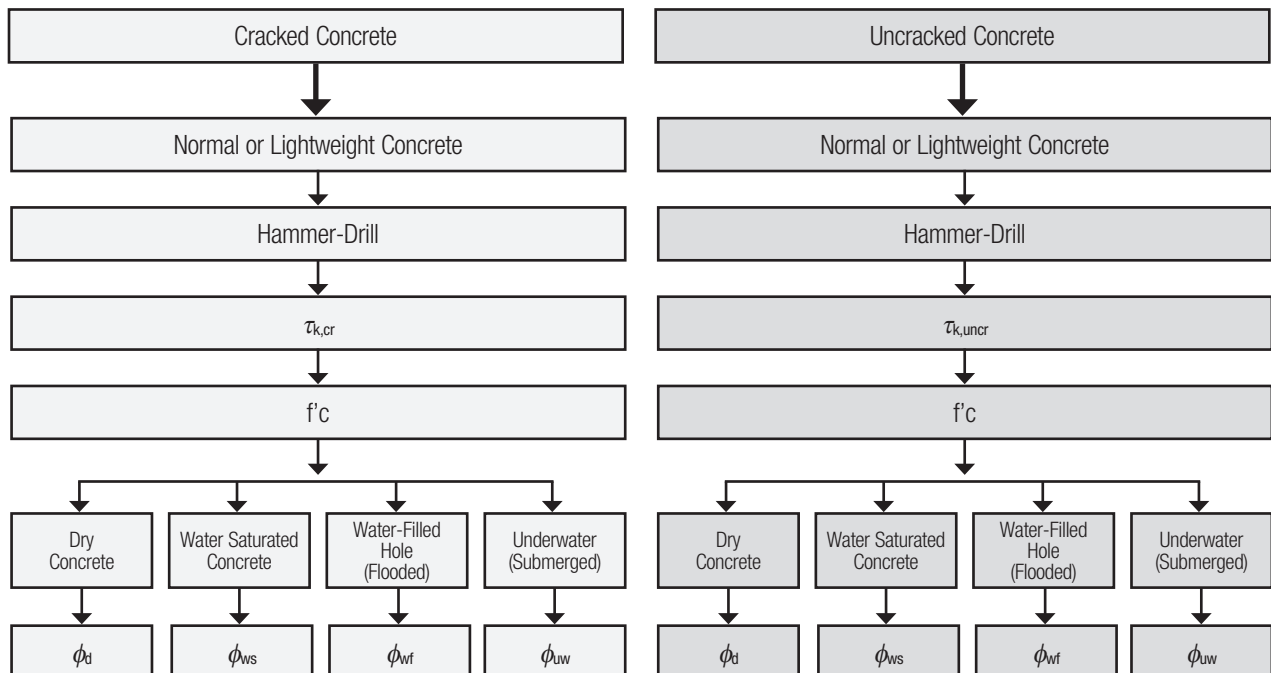

Bond Strength Design Information for Threaded Rods and Reinforcing Bars^{1,2}



Design Information		Symbol	Units	Nominal Rod Diameter (inch)							
				3/8	1/2	5/8	3/4	7/8	1	1-1/4	
Minimum embedment		$h_{ef,min}$	inch (mm)	2-3/8 (60)	2-3/4 (70)	3-1/8 (79)	3-1/2 (89)	3-1/2 (89)	4 (102)	5 (127)	
Maximum embedment		$h_{ef,max}$	inch (mm)	7-1/2 (191)	10 (254)	12-1/2 (318)	15 (381)	17-1/2 (445)	20 (508)	25 (635)	
110°F (43°C) Maximum Long-Term Service Temperature; 140°F (60°C) Maximum Short-Term Service Temperature ^{3,5}	Characteristic bond strength in cracked concrete ^{6,9}	$\tau_{k,cr}$	psi (N/mm ²)	1,206 (8.3)	1,206 (8.3)	1,206 (8.3)	1,206 (8.3)	1,206 (8.3)	1,206 (8.3)	1,206 (8.3)	
	Characteristic bond strength in cracked concrete, short-term loading only ⁸	$\tau_{k,cr}$	psi (N/mm ²)	1,206 (8.3)	1,206 (8.3)	1,206 (8.3)	1,206 (8.3)	1,206 (8.3)	1,206 (8.3)	1,206 (8.3)	
	Characteristic bond strength in uncracked concrete ^{6,8}	$\tau_{k,uncr}$	psi (N/mm ²)	1,829 (12.6)	1,738 (12.0)	1,671 (11.5)	1,617 (11.1)	1,567 (10.8)	1,538 (10.6)	1,479 (10.2)	
	Characteristic bond strength in uncracked concrete, short-term loading only ⁸	$\tau_{k,uncr}$	psi (N/mm ²)	1,829 (12.6)	1,738 (12.0)	1,671 (11.5)	1,617 (11.1)	1,567 (10.8)	1,538 (10.6)	1,479 (10.2)	
110°F (43°C) Maximum Long-Term Service Temperature; 176°F (80°C) Maximum Short-Term Service Temperature ^{3,5}	Characteristic bond strength in cracked concrete ^{6,9}	$\tau_{k,cr}$	psi (N/mm ²)	882 (6.1)	882 (6.1)	882 (6.1)	882 (6.1)	882 (6.1)	882 (6.1)	882 (6.1)	
	Characteristic bond strength in cracked concrete, short-term loading only ⁸	$\tau_{k,cr}$	psi (N/mm ²)	882 (6.1)	882 (6.1)	882 (6.1)	882 (6.1)	882 (6.1)	882 (6.1)	882 (6.1)	
	Characteristic bond strength in uncracked concrete ^{6,8}	$\tau_{k,uncr}$	psi (N/mm ²)	1,334 (9.2)	1,262 (8.7)	1,218 (8.4)	1,175 (8.1)	1,146 (7.9)	1,117 (7.7)	1,073 (7.4)	
	Characteristic bond strength in uncracked concrete, short-term loading only ⁸	$\tau_{k,uncr}$	psi (N/mm ²)	1,334 (9.2)	1,262 (8.7)	1,218 (8.4)	1,175 (8.1)	1,146 (7.9)	1,117 (7.7)	1,073 (7.4)	
Design Information		Symbol	Units	Nominal Bar Size							
Minimum embedment		$h_{ef,min}$	inch (mm)	2-3/8 (60.0)	2-3/4 (70.0)	3-1/8 (79.0)	3-1/2 (89.0)	3-1/2 (89.0)	4 (102.0)	4-1/2 (114.0)	5 (127.0)
Maximum embedment		$h_{ef,max}$	inch (mm)	7-1/2 (191.0)	10 (254.0)	12-1/2 (318.0)	15 (381.0)	17-1/2 (445.0)	20 (508.0)	22-1/2 (572.0)	25 (635.0)
110°F (43°C) Maximum Long-Term Service Temperature; 140°F (60°C) Maximum Short-Term Service Temperature ^{3,5}	Characteristic bond strength in cracked concrete ^{6,9}	$\tau_{k,cr}$	psi (N/mm ²)	1,206 (8.3)	1,170 (8.1)	1,122 (7.7)	1,122 (7.7)	1,122 (7.7)	1,122 (7.7)	1,122 (7.7)	1,122 (7.7)
	Characteristic bond strength in cracked concrete, short-term loading only ⁸	$\tau_{k,cr}$	psi (N/mm ²)	1,206 (8.3)	1,170 (8.1)	1,122 (7.7)	1,122 (7.7)	1,122 (7.7)	1,122 (7.7)	1,122 (7.7)	1,122 (7.7)
	Characteristic bond strength in uncracked concrete ^{6,8}	$\tau_{k,uncr}$	psi (N/mm ²)	1,829 (12.6)	1,738 (12.0)	1,671 (11.5)	1,617 (11.1)	1,567 (10.8)	1,538 (10.6)	1,507 (10.4)	1,479 (10.2)
	Characteristic bond strength in uncracked concrete, short-term loading only ⁸	$\tau_{k,uncr}$	psi (N/mm ²)	1,829 (12.6)	1,738 (12.0)	1,671 (11.5)	1,617 (11.1)	1,567 (10.8)	1,538 (10.6)	1,507 (10.4)	1,479 (10.2)
110°F (43°C) Maximum Long-Term Service Temperature; 176°F (80°C) Maximum Short-Term Service Temperature ^{3,5}	Characteristic bond strength in cracked concrete ^{6,9}	$\tau_{k,cr}$	psi (N/mm ²)	882 (6.1)	848 (5.8)	814 (5.6)	814 (5.6)	814 (5.6)	814 (5.6)	814 (5.6)	814 (5.6)
	Characteristic bond strength in cracked concrete, short-term loading only ⁸	$\tau_{k,cr}$	psi (N/mm ²)	882 (6.1)	848 (5.8)	814 (5.6)	814 (5.6)	814 (5.6)	814 (5.6)	814 (5.6)	814 (5.6)
	Characteristic bond strength in uncracked concrete ^{6,8}	$\tau_{k,uncr}$	psi (N/mm ²)	1,334 (9.2)	1,262 (8.7)	1,218 (8.4)	1,175 (8.1)	1,146 (7.9)	1,117 (7.7)	1,102 (7.6)	1,073 (7.4)
	Characteristic bond strength in uncracked concrete, short-term loading only ⁸	$\tau_{k,uncr}$	psi (N/mm ²)	1,334 (9.2)	1,262 (8.7)	1,218 (8.4)	1,175 (8.1)	1,146 (7.9)	1,117 (7.7)	1,102 (7.6)	1,073 (7.4)
Permissible installation conditions ⁷	Dry concrete	Anchor Category		1							
		ϕ_s		0.65							
	Water-saturated concrete, Water-filled hole (flooded)	Anchor Category		2							
		ϕ_{ws}, ϕ_{wf}		0.55							
Underwater (submerged)	Anchor Category		2				3				
	ϕ_{uw}		0.55				0.45				
Reduction factor for seismic tension ⁹		$\alpha_{N,seis}$		1.00							

For St: 1 inch = 25.4 mm, 1 psi = 0.006894 MPa. For pound-inch units: 1 mm = 0.03937 inch, 1 MPa = 145.0 psi.

- Bond strength values correspond to a normal-weight concrete compressive strength $f'_c = 2,500$ psi (17.2 MPa). For concrete compressive strength, f'_c between 2,500 psi and 8,000 psi (17.2 MPa and 55.2 MPa), the tabulated characteristic bond strength may be increased by a factor of $(f'_c / 2,500)^{0.25}$ [For St: $(f'_c / 17.2)^{0.25}$].
- The modification factor for bond strength of adhesive anchors in lightweight concrete shall be taken as given in ACI 318-14 17.2.6 or ACI 318-11 D.3.6, as applicable, where applicable.
- The maximum short-term service temperature may be increased to 162°F (72°C) provided characteristic bond strengths are reduced by 3 percent. Long-term and short-term temperatures meet the requirements of Section 8.5 of ACI 355.4 and Table 8.1, Temperature Category B.
- Long-term and short-term temperatures meet the requirements of Section 8.5 of ACI 355.4 and Table 8.1, Temperature Category A.
- Short-term base material service temperatures are those that occur over brief intervals, e.g. as a result of diurnal cycling. Long-term elevated concrete base material service temperatures are roughly constant over significant periods of time.
- Characteristic bond strengths are for sustained loads including dead and live loads.
- Permissible installation conditions include dry concrete, water-saturated concrete, water-filled holes and underwater. Water-filled holes include applications in dry or water-saturated concrete where the drilled holes contain standing water at the time of anchor installation.
- Bond strength values for uncracked concrete are applicable for structures assigned to Seismic Design Categories A and B only.
- For structures assigned to Seismic Design Categories C, D, E or F, the tabulated bond strength values for cracked concrete do not require an additional reduction factor applied for seismic tension ($\alpha_{N,seis} = 1.0$), where seismic design is applicable.



Tension and Shear Design Strength for Threaded Rod Installed in Uncracked Concrete (Bond or Concrete Strength)

Drilled with a Hammer-Drill and Carbide Bit in a Dry Hole Condition

110°F (43°C) Maximum Long-Term Service Temperature;

140°F (60°C) Maximum Short-Term Service Temperature^{1,2,3,4,5,6,7,8,9}

Nominal Rod/Rebar Size (in.)	Embed. Depth h_{ef} (in.)	Minimum Concrete Compressive Strength									
		$f'c = 2,500$ (psi)		$f'c = 3,000$ (psi)		$f'c = 4,000$ (psi)		$f'c = 6,000$ (psi)		$f'c = 8,000$ (psi)	
		ϕN_{cb} or ϕN_{ta} Tension (lbs.)	ϕN_{cb} or ϕN_{cp} Shear (lbs.)	ϕN_{cb} or ϕN_{ta} Tension (lbs.)	ϕN_{cb} or ϕN_{cp} Shear (lbs.)	ϕN_{cb} or ϕN_{ta} Tension (lbs.)	ϕN_{cb} or ϕN_{cp} Shear (lbs.)	ϕN_{cb} or ϕN_{ta} Tension (lbs.)	ϕN_{cb} or ϕN_{cp} Shear (lbs.)	ϕN_{cb} or ϕN_{ta} Tension (lbs.)	ϕN_{cb} or ϕN_{cp} Shear (lbs.)
3/8	2-3/8	2,855	2,570	3,125	2,920	3,610	3,575	4,070	4,380	4,345	4,680
	3	4,055	4,010	4,380	4,530	4,680	5,370	5,140	6,830	5,490	8,095
	4-1/2	6,305	7,420	6,575	8,270	7,020	9,805	7,710	12,465	8,235	14,775
	7-1/2	10,505	15,800	10,955	17,600	11,705	20,865	12,845	26,530	13,725	29,565
1/2	2-3/4	3,555	3,305	3,895	3,755	4,500	4,590	5,510	6,095	6,365	7,455
	4	6,240	6,700	6,835	7,610	7,895	9,310	8,680	11,845	9,275	14,045
	6	10,645	12,850	11,105	14,315	11,865	16,970	13,020	21,575	13,915	25,585
	10	17,745	27,370	18,505	30,485	19,770	36,150	21,705	45,955	23,190	49,945
5/8	3-1/8	4,310	4,120	4,720	4,680	5,450	5,725	6,675	7,600	7,710	9,295
	5	8,720	10,005	9,555	11,365	11,030	13,900	13,040	18,205	13,935	21,585
	7-1/2	15,995	19,745	16,680	22,000	17,820	26,080	19,565	33,160	20,900	39,315
	12-1/2	26,660	42,065	27,800	46,860	29,700	55,560	32,605	70,225	34,835	75,030
3/4	3-1/2	5,105	5,015	5,595	5,700	6,460	6,970	7,910	9,255	9,135	11,320
	6	11,465	13,595	12,560	15,445	14,500	18,895	17,760	25,095	19,415	30,030
	9	21,060	26,855	23,070	30,510	24,835	36,285	27,260	46,130	29,125	54,695
	15	37,145	58,530	38,740	65,200	41,390	77,305	45,435	97,855	48,540	104,550
7/8	3-1/2	5,105	4,930	5,595	5,605	6,460	6,855	7,910	9,100	9,135	11,130
	7	14,445	16,605	15,825	18,865	18,275	23,075	22,380	30,650	25,610	37,355
	10-1/2	26,540	32,800	29,070	37,265	32,755	45,135	35,955	57,380	38,415	68,035
	17-1/2	49,000	72,810	51,095	81,105	54,590	96,165	59,930	122,255	64,025	137,905
1	4	6,240	6,115	6,835	6,945	7,895	8,495	9,665	11,280	11,160	13,800
	8	17,650	19,750	19,335	22,435	22,325	27,440	27,340	36,450	31,570	44,580
	12	32,425	39,005	35,520	44,315	41,015	54,200	46,095	69,560	49,250	82,475
	20	62,815	88,270	65,505	98,330	69,985	116,585	76,825	148,215	82,080	175,735
1-1/4	5	8,720	8,170	9,555	9,285	11,030	11,355	13,510	15,085	15,600	18,450
	10	24,665	26,380	27,020	29,975	31,200	36,660	38,210	48,690	44,125	59,555
	15	45,315	52,110	49,640	59,200	57,320	72,410	69,260	95,655	74,000	113,420
	25	94,380	121,400	98,420	135,235	105,155	160,345	115,435	203,845	123,330	241,695

■ - Concrete Breakout Strength □ - Bond Strength/Pryout Strength

- Tabular values are provided for illustration and are applicable for single anchors installed in uncracked normal-weight concrete with minimum slab thickness, $h_{sa} = h_{min}$, and with the following conditions:
 - C_{a1} is greater than or equal to the critical edge distance, C_{ac}
 - C_{a2} is greater than or equal to 1.5 times C_{a1} .
- Calculations were performed according to ACI 318-14 Ch.17 and ICC-ES AC308. The load level corresponding to the failure mode listed [Concrete breakout strength, bond strength/pryout strength] must be checked against the tabulated steel strength of the corresponding threaded rod or rebar size and type, the lowest load level controls.
- Strength reduction factors (ϕ) for concrete breakout strength are based on ACI 318-14 Section 5.3 for load combinations. Condition B was assumed.
- Strength reduction factors (ϕ) for bond strength are determined from reliability testing and qualification in accordance with ICC-ES AC308 and are tabulated in this product information and in ESR-3298.
- Tabular values are permitted for static loads only, seismic loading is not considered with these tables. Periodic special inspection must be performed where required by code, see ESR-3298 for applicable information.
- For anchors subjected to tension resulting from sustained loading a supplemental check must be performed according to ACI 318-14 17.3.1.2.
- For designs that include combined tension and shear, the interaction of tension and shear loads must be calculated in accordance with ACI 318-14 Ch.17.
- Interpolation is not permitted to be used with the tabular values. For intermediate base material compressive strengths, please see ACI 318-14 Ch.17, ICC-ES AC308 and information included in this product supplement. For other design conditions including seismic considerations please see ACI 318-14 Ch.17 and ICC-ES AC308 and ESR-3298.
- Long term concrete temperatures are roughly constant over significant periods of time. Short-term elevated temperatures are those that occur over brief intervals, e.g. as a result of diurnal cycling.

ADHESIVES

PURE110+®

Epoxy Injection Adhesive Anchoring System



ADHESIVES

PURE110+®
Epoxy Injection Adhesive Anchoring System

Tension and Shear Design Strength for Threaded Rod Installed in Cracked Concrete (Bond or Concrete Strength)
Drilled with a Hammer-Drill and Carbide Bit in a Dry Hole Condition
110°F (43°C) Maximum Long-Term Service Temperature;
140°F (60°C) Maximum Short-Term Service Temperature^{1,2,3,4,5,6,7,8,9}

Nominal Rod/Rebar Size (in. or #)	Embed. Depth h _{ef} (in.)	Minimum Concrete Compressive Strength									
		f'c = 2,500 (psi)		f'c = 3,000 (psi)		f'c = 4,000 (psi)		f'c = 6,000 (psi)		f'c = 8,000 (psi)	
		ϕN_{cb} or ϕN_a Tension (lbs.)	ϕN_{cb} or ϕN_{cp} Shear (lbs.)	ϕN_{cb} or ϕN_a Tension (lbs.)	ϕN_{cb} or ϕN_{cp} Shear (lbs.)	ϕN_{cb} or ϕN_a Tension (lbs.)	ϕN_{cb} or ϕN_{cp} Shear (lbs.)	ϕN_{cb} or ϕN_a Tension (lbs.)	ϕN_{cb} or ϕN_{cp} Shear (lbs.)	ϕN_{cb} or ϕN_a Tension (lbs.)	ϕN_{cb} or ϕN_{cp} Shear (lbs.)
3/8	2-3/8	2,020	1,835	2,215	2,085	2,445	2,555	2,685	2,890	2,865	3,085
	3	2,770	2,865	2,890	3,235	3,085	3,835	3,390	4,875	3,620	5,785
	4-1/2	4,155	5,300	4,335	5,905	4,630	7,005	5,085	8,900	5,430	10,555
	7-1/2	6,925	11,285	7,225	12,570	7,715	14,905	8,470	18,245	9,050	19,495
1/2	2-3/4	2,520	2,360	2,760	2,680	3,185	3,280	3,905	4,355	4,425	5,325
	4	4,420	4,785	4,840	5,435	5,490	6,650	6,025	8,460	6,435	10,030
	6	7,390	9,180	7,705	10,225	8,230	12,125	9,035	15,410	9,655	18,275
	10	12,315	19,550	12,840	21,775	13,720	25,820	15,060	32,435	16,090	34,655
5/8	3-1/8	3,050	2,940	3,345	3,340	3,860	4,090	4,730	5,430	5,460	6,640
	5	6,175	7,145	6,765	8,120	7,815	9,930	9,415	13,005	10,055	15,415
	7-1/2	11,350	14,105	12,040	15,715	12,860	18,630	14,120	23,685	15,085	28,080
	12-1/2	19,240	30,045	20,065	33,470	21,435	39,685	23,530	50,455	25,140	54,150
3/4	3-1/2	3,620	3,580	3,965	4,070	4,575	4,980	5,605	6,610	6,470	8,085
	6	8,120	9,710	8,895	11,035	10,270	13,495	12,580	17,925	14,480	21,450
	9	14,920	19,185	16,340	21,795	18,520	25,920	20,330	32,950	21,720	39,070
	15	27,705	41,805	28,890	46,570	30,870	55,220	33,885	70,200	36,205	77,975
7/8	3-1/2	3,620	3,525	3,965	4,000	4,575	4,895	5,605	6,500	6,470	7,950
	7	10,230	11,860	11,210	13,475	12,945	16,485	15,850	21,895	18,305	26,680
	10-1/2	18,800	23,430	20,590	26,620	23,780	32,240	27,675	40,985	29,565	48,595
	17-1/2	37,710	52,005	39,325	57,935	42,015	68,690	46,120	87,325	49,275	103,540
1	4	4,420	4,365	4,840	4,960	5,590	6,065	6,845	8,060	7,905	9,855
	8	12,500	14,105	13,695	16,025	15,815	19,600	19,365	26,035	22,365	31,845
	12	22,965	27,860	25,160	31,655	29,050	38,715	35,580	49,685	38,615	58,910
	20	49,255	63,050	51,365	70,235	54,875	83,275	60,240	105,870	64,360	125,525
1-1/4	5	6,175	5,835	6,765	6,630	7,815	8,110	9,570	10,775	11,050	13,175
	10	17,470	18,845	19,140	21,410	22,100	26,185	27,065	34,780	31,255	42,540
	15	32,095	37,220	35,160	42,285	40,600	51,720	49,725	68,325	57,415	81,015
	25	69,060	86,715	75,655	96,595	85,745	114,530	94,125	145,605	100,565	172,640

■ - Concrete Breakout Strength ■ - Bond Strength/Pryout Strength

- Tabular values are provided for illustration and are applicable for single anchors installed in cracked normal-weight concrete with minimum slab thickness, $h_a = h_{min}$, and with the following conditions:
 - C_{a1} is greater than or equal to the critical edge distance, C_{ac}
 - C_{a2} is greater than or equal to 1.5 times C_{a1} .
- Calculations were performed according to ACI 318-14 Ch.17 and ICC-ES AC308. The load level corresponding to the failure mode listed [Concrete breakout strength, bond strength/pryout strength] must be checked against the tabulated steel strength of the corresponding threaded rod or rebar size and type, the lowest load level controls.
- Strength reduction factors (ϕ) for concrete breakout strength are based on ACI 318-14 Section 5.3 for load combinations. Condition B was assumed.
- Strength reduction factors (ϕ) for bond strength are determined from reliability testing and qualification in accordance with ICC-ES AC308 and are tabulated in this product information and in ESR-3298.
- Tabular values are permitted for static loads only, seismic loading is not considered with these tables. Periodic special inspection must be performed where required by code, see ESR-3298 for applicable information.
- For anchors subjected to tension resulting from sustained loading a supplemental check must be performed according to ACI 318-14 17.3.1.2.
- For designs that include combined tension and shear, the interaction of tension and shear loads must be calculated in accordance with ACI 318-14 Ch.17.
- Interpolation is not permitted to be used with the tabular values. For intermediate base material compressive strengths, please see ACI 318-14 Ch.17, ICC-ES AC308 and information included in this product supplement. For other design conditions including seismic considerations please see ACI 318-14 Ch.17 and ICC-ES AC308 and ESR-3298.
- Long term concrete temperatures are roughly constant over significant periods of time. Short-term elevated temperatures are those that occur over brief intervals, e.g. as a result of diurnal cycling.



Tension and Shear Design Strength for Reinforcing Bar Installed in Uncracked Concrete (Bond or Concrete Strength)

Drilled with a Hammer-Drill and Carbide Bit in a Dry Hole Condition

110°F (43°C) Maximum Long-Term Service Temperature;

140°F (60°C) Maximum Short-Term Service Temperature^{1,2,3,4,5,6,7,8,9}

Nominal Rod/Rebar Size (#)	Embed. Depth h_{ef} (in.)	Minimum Concrete Compressive Strength									
		$f'c = 2,500$ (psi)		$f'c = 3,000$ (psi)		$f'c = 4,000$ (psi)		$f'c = 6,000$ (psi)		$f'c = 8,000$ (psi)	
		ϕN_{cb} or ϕN_{ta} Tension (lbs.)	ϕN_{cb} or ϕN_{cp} Shear (lbs.)	ϕN_{cb} or ϕN_{ta} Tension (lbs.)	ϕN_{cb} or ϕN_{cp} Shear (lbs.)	ϕN_{cb} or ϕN_{ta} Tension (lbs.)	ϕN_{cb} or ϕN_{cp} Shear (lbs.)	ϕN_{cb} or ϕN_{ta} Tension (lbs.)	ϕN_{cb} or ϕN_{cp} Shear (lbs.)	ϕN_{cb} or ϕN_{ta} Tension (lbs.)	ϕN_{cb} or ϕN_{cp} Shear (lbs.)
#3	2-3/8	2,855	2,570	3,125	2,920	3,610	3,575	4,070	4,380	4,345	4,680
	3	4,055	4,010	4,380	4,530	4,680	5,370	5,140	6,830	5,490	8,095
	4-1/2	6,305	7,420	6,575	8,270	7,020	9,805	7,710	12,465	8,235	14,775
	7-1/2	10,505	15,800	10,955	17,600	11,705	20,865	12,845	26,530	13,725	29,565
#4	2-3/4	3,555	3,305	3,895	3,755	4,500	4,590	5,510	6,095	6,365	7,455
	4	6,240	6,700	6,835	7,610	7,895	9,310	8,680	11,845	9,275	14,045
	6	10,645	12,850	11,105	14,315	11,865	16,970	13,020	21,575	13,915	25,585
	10	17,745	27,370	18,505	30,485	19,770	36,150	21,705	45,955	23,190	49,945
#5	3-1/8	4,310	4,120	4,720	4,680	5,450	5,725	6,675	7,600	7,710	9,295
	5	8,720	10,005	9,555	11,365	11,030	13,900	13,040	18,205	13,935	21,585
	7-1/2	15,995	19,745	16,680	22,000	17,820	26,080	19,565	33,160	20,900	39,315
	12-1/2	26,660	42,065	27,800	46,860	29,700	55,560	32,605	70,225	34,835	75,030
#6	3-1/2	5,105	5,015	5,595	5,700	6,460	6,970	7,910	9,255	9,135	11,320
	6	11,465	13,595	12,560	15,445	14,500	18,895	17,760	25,095	19,415	30,030
	9	21,060	26,855	23,070	30,510	24,835	36,285	27,260	46,130	29,125	54,695
	15	37,145	58,530	38,740	65,200	41,390	77,305	45,435	97,855	48,540	104,550
#7	3-1/2	5,105	4,930	5,595	5,605	6,460	6,855	7,910	9,100	9,135	11,130
	7	14,445	16,605	15,825	18,865	18,275	23,075	22,380	30,650	25,610	37,355
	10-1/2	26,540	32,800	29,070	37,265	32,755	45,135	35,955	57,380	38,415	68,035
	17-1/2	49,000	72,810	51,095	81,105	54,590	96,165	59,930	122,255	64,025	137,905
#8	4	6,240	6,115	6,835	6,945	7,895	8,495	9,665	11,280	11,160	13,800
	8	17,650	19,750	19,335	22,435	22,325	27,440	27,340	36,450	31,570	44,580
	12	32,425	39,005	35,520	44,315	41,015	54,200	46,095	69,560	49,250	82,475
	20	62,815	88,270	65,505	98,330	69,985	116,585	76,825	148,215	82,080	175,735
#9	4-1/2	7,445	7,110	8,155	8,080	9,420	9,880	11,535	13,125	13,320	16,055
	9	21,060	23,055	23,070	26,190	26,640	32,035	32,625	42,550	37,675	52,040
	13-1/2	38,690	45,540	42,380	51,740	48,940	63,280	57,165	82,475	61,075	97,785
	22-1/2	77,895	104,620	81,230	116,545	86,790	138,185	95,270	175,670	101,790	208,290
#10	5	8,720	8,160	9,555	9,270	11,030	11,335	13,510	15,060	15,600	18,420
	10	24,665	26,430	27,020	30,025	31,200	36,725	38,210	48,780	44,125	59,660
	15	45,315	52,205	49,640	59,310	57,320	72,545	69,260	95,835	74,000	113,625
	25	94,380	121,580	98,420	135,435	105,155	160,580	115,435	204,145	123,330	242,050

■ - Concrete Breakout Strength ■ - Bond Strength/Pryout Strength

- Tabular values are provided for illustration and are applicable for single anchors installed in uncracked normal-weight concrete with minimum slab thickness, $h_a = h_{min}$, and with the following conditions:
 - C_{a1} is greater than or equal to the critical edge distance, C_{ac}
 - C_{a2} is greater than or equal to 1.5 times C_{a1} .
- Calculations were performed according to ACI 318-14 Ch.17 and ICC-ES AC308. The load level corresponding to the failure mode listed [Concrete breakout strength, bond strength/pryout strength] must be checked against the tabulated steel strength of the corresponding threaded rod or rebar size and type, the lowest load level controls.
- Strength reduction factors (ϕ) for concrete breakout strength are based on ACI 318-14 Section 5.3 for load combinations. Condition B was assumed.
- Strength reduction factors (ϕ) for bond strength are determined from reliability testing and qualification in accordance with ICC-ES AC308 and are tabulated in this product information and in ESR-3298.
- Tabular values are permitted for static loads only, seismic loading is not considered with these tables. Periodic special inspection must be performed where required by code, see ESR-3298 for applicable information.
- For anchors subjected to tension resulting from sustained loading a supplemental check must be performed according to ACI 318-14 17.3.1.2.
- For designs that include combined tension and shear, the interaction of tension and shear loads must be calculated in accordance with ACI 318-14 Ch.17.
- Interpolation is not permitted to be used with the tabular values. For intermediate base material compressive strengths, please see ACI 318-14 Ch.17, ICC-ES AC308 and information included in this product supplement. For other design conditions including seismic considerations please see ACI 318-14 Ch.17 and ICC-ES AC308 and ESR-3298.
- Long term concrete temperatures are roughly constant over significant periods of time. Short-term elevated temperatures are those that occur over brief intervals, e.g. as a result of diurnal cycling.

ADHESIVES

PURE1 10+

Epoxy Injection Adhesive Anchoring System



Tension and Shear Design Strength for Reinforcing Bar Installed in Cracked Concrete (Bond or Concrete Strength)
Drilled with a Hammer-Drill and Carbide Bit in a Dry Hole Condition
110°F (43°C) Maximum Long-Term Service Temperature;
140°F (60°C) Maximum Short-Term Service Temperature^{1,2,3,4,5,6,7,8,9}

Nominal Rod/Rebar Size (#)	Embed. Depth h _{ef} (in.)	Minimum Concrete Compressive Strength									
		f' _c = 2,500 (psi)		f' _c = 3,000 (psi)		f' _c = 4,000 (psi)		f' _c = 6,000 (psi)		f' _c = 8,000 (psi)	
		ϕN_{cb} or ϕN_a Tension (lbs.)	ϕN_{cb} or ϕN_{cp} Shear (lbs.)	ϕN_{cb} or ϕN_a Tension (lbs.)	ϕN_{cb} or ϕN_{cp} Shear (lbs.)	ϕN_{cb} or ϕN_a Tension (lbs.)	ϕN_{cb} or ϕN_{cp} Shear (lbs.)	ϕN_{cb} or ϕN_a Tension (lbs.)	ϕN_{cb} or ϕN_{cp} Shear (lbs.)	ϕN_{cb} or ϕN_a Tension (lbs.)	ϕN_{cb} or ϕN_{cp} Shear (lbs.)
#3	2-3/8	2,020	1,835	2,215	2,085	2,445	2,555	2,685	2,890	2,865	3,085
	3	2,770	2,865	2,890	3,235	3,085	3,835	3,390	4,875	3,620	5,785
	4-1/2	4,155	5,300	4,335	5,905	4,630	7,005	5,085	8,900	5,430	10,555
	7-1/2	6,925	11,285	7,225	12,570	7,715	14,905	8,470	18,245	9,050	19,495
#4	2-3/4	2,520	2,360	2,760	2,680	3,185	3,280	3,905	4,355	4,295	5,325
	4	4,420	4,785	4,840	5,435	5,325	6,650	5,845	8,460	6,245	10,030
	6	7,170	9,180	7,475	10,225	7,985	12,125	8,765	15,410	9,365	18,275
#5	10	11,945	19,550	12,455	21,775	13,310	25,820	14,610	31,470	15,610	33,620
	3-1/8	3,050	2,940	3,345	3,340	3,860	4,090	4,730	5,430	5,380	6,640
	5	6,175	7,145	6,765	8,120	7,815	9,930	8,755	13,005	9,355	15,415
#6	7-1/2	10,740	14,105	11,200	15,715	11,965	18,630	13,135	23,685	14,035	28,080
	12-1/2	17,900	30,045	18,665	33,470	19,945	39,685	21,890	47,155	23,390	50,380
	3-1/2	3,620	3,580	3,965	4,070	4,575	4,980	5,605	6,610	6,470	8,085
#7	6	8,120	9,710	8,895	11,035	10,270	13,495	12,580	17,925	13,475	21,450
	9	14,920	19,185	16,130	21,795	17,230	25,920	18,915	32,950	20,210	39,070
	15	25,775	41,805	26,880	46,570	28,720	55,220	31,525	67,900	33,680	72,545
#8	3-1/2	3,620	3,525	3,965	4,000	4,575	4,895	5,605	6,500	6,470	7,950
	7	10,230	11,860	11,210	13,475	12,945	16,485	15,850	21,895	18,305	26,680
	10-1/2	18,800	23,430	20,590	26,620	23,455	32,240	25,745	40,985	27,505	48,595
#9	17-1/2	35,085	52,005	36,585	57,935	39,090	68,690	42,910	87,325	45,845	98,740
	4	4,420	4,365	4,840	4,960	5,590	6,065	6,845	8,060	7,905	9,855
	8	12,500	14,105	13,695	16,025	15,815	19,600	19,365	26,035	22,365	31,845
#10	12	22,965	27,860	25,160	31,655	29,050	38,715	33,625	49,685	35,925	58,910
	20	45,825	63,050	47,785	70,235	51,055	83,275	56,045	105,870	59,880	125,525
	4-1/2	5,275	5,080	5,780	5,770	6,670	7,060	8,170	9,375	9,435	11,465
#11	9	14,920	16,465	16,340	18,710	18,870	22,880	23,110	30,390	26,685	37,170
	13-1/2	27,405	32,530	30,020	36,955	34,665	45,200	42,455	58,910	45,470	69,845
	22-1/2	57,995	74,730	60,480	83,245	64,615	98,700	70,930	125,480	75,785	148,775
#12	5	6,175	5,830	6,765	6,620	7,815	8,100	9,570	10,755	11,050	13,155
	10	17,470	18,880	19,140	21,445	22,100	26,230	27,065	34,840	31,255	42,615
	15	32,095	37,290	35,160	42,365	40,600	51,815	49,725	68,455	56,135	81,160
#13	25	69,060	86,840	74,665	96,740	79,775	114,700	87,570	145,820	93,560	172,890

■ - Concrete Breakout Strength □ - Bond Strength/Pryout Strength

- Tabular values are provided for illustration and are applicable for single anchors installed in cracked normal-weight concrete with minimum slab thickness, $h_a = h_{min}$, and with the following conditions:
 - C_{a1} is greater than or equal to the critical edge distance, C_{ac}
 - C_{a2} is greater than or equal to 1.5 times C_{a1} .
- Calculations were performed according to ACI 318-14 Ch.17 and ICC-ES AC308. The load level corresponding to the failure mode listed [Concrete breakout strength, bond strength/pryout strength] must be checked against the tabulated steel strength of the corresponding threaded rod or rebar size and type, the lowest load level controls.
- Strength reduction factors (ϕ) for concrete breakout strength are based on ACI 318-14 Section 5.3 for load combinations. Condition B was assumed.
- Strength reduction factors (ϕ) for bond strength are determined from reliability testing and qualification in accordance with ICC-ES AC308 and are tabulated in this product information and in ESR-3298.
- Tabular values are permitted for static loads only, seismic loading is not considered with these tables. Periodic special inspection must be performed where required by code, see ESR-3298 for applicable information.
- For anchors subjected to tension resulting from sustained loading a supplemental check must be performed according to ACI 318-14 17.3.1.2.
- For designs that include combined tension and shear, the interaction of tension and shear loads must be calculated in accordance with ACI 318-14 Ch.17.
- Interpolation is not permitted to be used with the tabular values. For intermediate base material compressive strengths, please see ACI 318-14 Ch.17, ICC-ES AC308 and information included in this product supplement. For other design conditions including seismic considerations please see ACI 318-14 Ch.17 and ICC-ES AC308 and ESR-3298.
- Long term concrete temperatures are roughly constant over significant periods of time. Short-term elevated temperatures are those that occur over brief intervals, e.g. as a result of diurnal cycling.



Tension Design of Steel Elements (Steel Strength)^{1,2}

Steel Elements - Threaded Rod and Reinforcing Bar												
Nominal Rod/Rebar Size (in. or No.)	ASTM A36 and ASTM F1554 Grade 36	ASTM F1554 Grade 55	ASTM A193 Grade B7 and ASTM F1554 Grade 105	ASTM A449	ASTM F568M Class 5.8 and ISO 898-1 Class 5.8	ASTM F593 CW Stainless (Types 304 and 316)	ASTM A193 Grade B8/B8M, Class 1 Stainless (Types 304 and 316)	ASTM A193 Grade B8/B8M2, Class 2B Stainless (Types 304 and 316)	ASTM A615 Grade 75 Rebar	ASTM A615 Grade 60 Rebar	ASTM A706 Grade 60 Rebar	ASTM A615 Grade 40 Rebar
	ϕN_{sa} Tension (lbs.)	ϕN_{sa} Tension (lbs.)	ϕN_{sa} Tension (lbs.)	ϕN_{sa} Tension (lbs.)	ϕN_{sa} Tension (lbs.)	ϕN_{sa} Tension (lbs.)	ϕN_{sa} Tension (lbs.)	ϕN_{sa} Tension (lbs.)	ϕN_{sa} Tension (lbs.)	ϕN_{sa} Tension (lbs.)	ϕN_{sa} Tension (lbs.)	ϕN_{sa} Tension (lbs.)
3/8 or #3	3,370	4,360	7,265	6,975	3,655	5,040	3,315	5,525	7,150	7,425	6,600	4,950
1/2 or #4	6,175	7,980	13,300	12,770	6,690	9,225	6,070	10,110	13,000	13,500	12,000	9,000
5/8 or #5	9,835	12,715	21,190	20,340	10,650	14,690	9,660	16,105	20,150	20,925	18,600	13,950
3/4 or #6	14,550	18,815	31,360	30,105	15,765	18,480	14,300	23,830	28,600	29,700	26,400	19,800
7/8 or #7	20,085	25,970	43,285	41,930	21,760	25,510	19,735	32,895	39,000	40,500	36,000	-
1 or #8	26,350	34,070	56,785	54,515	28,545	33,465	25,895	43,160	51,350	53,325	47,400	-
#9	-	-	-	-	-	-	-	-	65,000	67,500	60,000	-
1-1/4 or #10	42,160	54,510	90,850	76,315	-	53,540	41,430	69,050	82,550	85,725	76,200	-

■ - Steel Strength

1. Steel tensile design strength according to ACI 318-14 Ch.17, $\phi N_{sa} = \phi \cdot A_{se,N} \cdot f_{uta}$
2. The tabulated steel design strength in tension must be checked against the bond strength/concrete capacity design strength to determine the controlling failure mode, the lowest load level controls.

Shear Design of Steel Elements (Steel Strength)^{1,2}

Steel Elements - Threaded Rod and Reinforcing Bar												
Nominal Rod/Rebar Size (in. or No.)	ASTM A36 and ASTM F1554 Grade 36	ASTM F1554 Grade 55	ASTM A193 Grade B7 and ASTM F1554 Grade 105	ASTM A449	ASTM F568M Class 5.8 and ISO 898-1 Class 5.8	ASTM F593 CW Stainless (Types 304 and 316)	ASTM A193 Grade B8/B8M, Class 1 Stainless (Types 304 and 316)	ASTM A193 Grade B8/B8M2, Class 2B Stainless (Types 304 and 316)	ASTM A615 Grade 75 Rebar	ASTM A615 Grade 60 Rebar	ASTM A706 Grade 60 Rebar	ASTM A615 Grade 40 Rebar
	ϕV_{sa} Shear (lbs.)	ϕV_{sa} Shear (lbs.)	ϕV_{sa} Shear (lbs.)	ϕV_{sa} Shear (lbs.)	ϕV_{sa} Shear (lbs.)	ϕV_{sa} Shear (lbs.)	ϕV_{sa} Shear (lbs.)	ϕV_{sa} Shear (lbs.)	ϕV_{sa} Shear (lbs.)	ϕV_{sa} Shear (lbs.)	ϕV_{sa} Shear (lbs.)	ϕV_{sa} Shear (lbs.)
3/8 or #3	1,755	2,265	3,775	3,625	2,025	2,790	1,725	2,870	3,960	3,860	3,430	2,575
1/2 or #4	3,210	4,150	6,915	6,640	3,705	5,110	3,155	5,255	7,200	7,020	6,240	4,680
5/8 or #5	5,115	6,610	11,020	10,575	5,900	8,135	5,025	8,375	11,160	10,880	9,670	7,255
3/4 or #6	7,565	9,785	16,305	15,655	8,730	10,235	7,435	12,390	15,840	15,445	13,730	10,295
7/8 or #7	10,445	13,505	22,505	21,805	12,050	14,130	10,265	17,105	21,600	21,060	18,720	-
1 or #8	13,700	17,715	29,525	28,345	15,810	18,535	13,465	22,445	28,440	27,730	24,650	-
#9	-	-	-	-	-	-	-	-	36,000	35,100	31,200	-
1-1/4 or #10	21,920	28,345	47,240	39,685	-	29,655	21,545	35,905	45,720	44,575	39,625	-

■ - Steel Strength

1. Steel shear design strength according to ACI 318-14 Ch.17, $\phi V_{sa} = \phi \cdot 0.60 \cdot A_{se,V} \cdot f_{uta}$
2. The tabulated steel design strength in shear must be checked against the bond strength/concrete capacity design strength to determine the controlling failure mode, the lowest load level controls.

ADHESIVES

PURE110+[®]

Epoxy Injection Adhesive Anchoring System

Development Lengths for Common Reinforcing Bar Connections^{1,2,3,6}

Design Information	Symbol	Reference Standard	Units	Nominal Rebar Size (US)								
				#3	#4	#5	#6	#7	#8	#9	#10	#11
Nominal rebar diameter	d_b	ASTM A615/A706, Grade 60 ($f_y = 60$ ksi)	in. (mm)	0.375 (9.5)	0.5 (12.7)	0.625 (15.9)	0.75 (19.1)	0.875 (22.2)	1 (25.4)	1.128 (28.6)	1.27 (32.3)	1.41 (35.8)
Nominal rebar area	A_b		in ² (mm ²)	0.11 (71)	0.2 (127)	0.31 (198)	0.44 (285)	0.6 (388)	0.79 (507)	1 (645)	1.27 (817)	1.56 (1006)
Development length in $f'_c = 2,500$ psi concrete ^{4,5}	l_d	ACI 318-14 25.4.2.3 or ACI 318-11 12.2.3 as applicable	in. (mm)	12 (305)	14.4 (366)	18 (457)	21.6 (549)	31.5 (800)	36 (914)	40.6 (1031)	45.7 (1161)	50.8 (1290)
Development length in $f'_c = 3,000$ psi concrete ^{4,5}			in. (mm)	12 (305)	13.1 (334)	16.4 (417)	19.7 (501)	28.8 (730)	32.9 (835)	37.1 (942)	41.7 (1060)	46.3 (1177)
Development length in $f'_c = 4,000$ psi concrete ^{4,5}			in. (mm)	12 (305)	12 (305)	14.2 (361)	17.1 (434)	24.9 (633)	28.5 (723)	32.1 (815)	36.2 (920)	40.1 (1019)
Development length in $f'_c = 6,000$ psi concrete ^{4,5}			in. (mm)	12 (305)	12 (305)	12 (305)	13.9 (354)	20.3 (516)	23.2 (590)	26.2 (666)	29.5 (750)	32.8 (832)
Development length in $f'_c = 8,000$ psi concrete ^{4,5}			in. (mm)	12 (305)	12 (305)	12 (305)	12.1 (307)	17.6 (443)	20.1 (511)	22.7 (577)	25.6 (649)	28.4 (721)

- For St: 1 inch = 25.4 mm, 1 lbf = 4.448 N, 1 psi = 0.006897 MPa; for pound-inch units: 1 mm = 0.03937 inches, 1 N = 0.2248 lbf, 1 MPa = 145.0 psi.
1. Calculated development lengths in accordance with ACI 318-14 25.4.2.3 or ACI 318-11 12.2.3, as applicable, for reinforcing bars are valid for static, wind, and earthquake loads.
 2. Calculated development lengths in SDC C through F must comply with ACI 318-14 Chapter 18 or ACI 318-11 Chapter 21, as applicable.
 3. For Class B splices, minimum length of lap for tension lap splices is $1.3l_d$ in accordance with ACI 318-14 25.5.2 and ACI 318-11 12.15.1, as applicable.
 4. For lightweight concrete, $\lambda = 0.75$; therefore multiply development lengths by 1.33 (increase development length by 33 percent), unless the provisions of ACI 318-14 25.4.2.4 or ACI 318-11 12.2.4 (d), as applicable, are met to permit alternate values of λ (e.g. for sand-lightweight concrete, $\lambda = 0.85$; therefore multiply development lengths by 1.18). Refer to ACI 318-14 19.2.4 or ACI 318-11 8.6.1, as applicable.
 5. $(\frac{C_b + K_{tr}}{d_b}) = 2.5$, $\psi_A = 1.0$, $\psi_E = 1.0$, $\psi_s = 0.8$ for $d_b \leq \#6$, 1.0 for $d_b > \#6$. Refer to ACI 318-14 25.4.2.4 or ACI 318-11 12.2.4, as applicable.
 6. Calculations may be performed for other steel grades and concrete compressive strengths per ACI 318-14 Chapter 25 or ACI 318-11 Chapter 12, as applicable.

Installation Parameters for Common Post-Installed Reinforcing Bar Connections

Parameter	Symbol	Units	Nominal Rebar Size (US)								
			#3	#4	#5	#6	#7	#8	#9	#10	#11
Nominal hole diameter ¹	d_o	in.	7/16	5/8	3/4	7/8	1	1-1/8	1-3/8	1-1/2	1-3/4
Effective embedment	h_{ef}	in.	Up to 7-1/2	Up to 10	Up to 12-1/2	Up to 15	Up to 17-1/2	Up to 20	Up to 22-1/2	Up to 25	Up to 27-1/2
Nominal hole diameter ¹	d_o	in.	1/2	5/8	3/4	1	1-1/8	1-1/4	1-3/8	1-1/2	1-3/4
Effective embedment	h_{ef}	in.	Up to 22-1/2	Up to 30	Up to 37-1/2	Up to 45	Up to 52-1/2	Up to 60	Up to 67-1/2	Up to 75	Up to 82-1/2

- For St: 1 inch = 25.4 mm,; for pound-inch units: 1 mm = 0.03937 inches.
1. For any case, it must be possible for the reinforcing bar (rebar) to be inserted into the cleaned hole without resistance.
 2. Consideration should be given regarding the commercial availability of carbide drill bits (including hollow drill bits) and diamond core bits, as applicable, with lengths necessary to achieve effective embedments for post-installed reinforcing bar connections.
 3. For fractional reinforcing bars where the effective embedment is listed for two nominal hole diameters, either nominal hole diameter may be used.

Installation Detail for Post-Installed Reinforcing Bar Connection

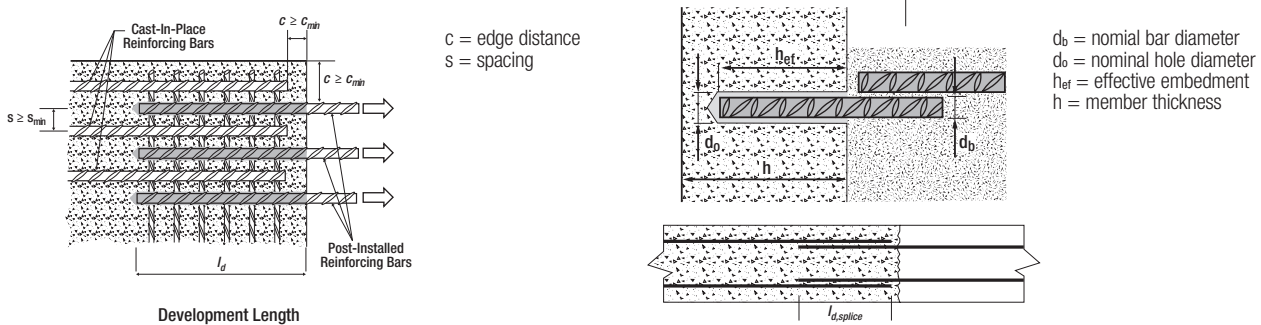

Examples of Development Length Application Details for Post-Installed Reinforcing Bar Connections Provided for Illustrator

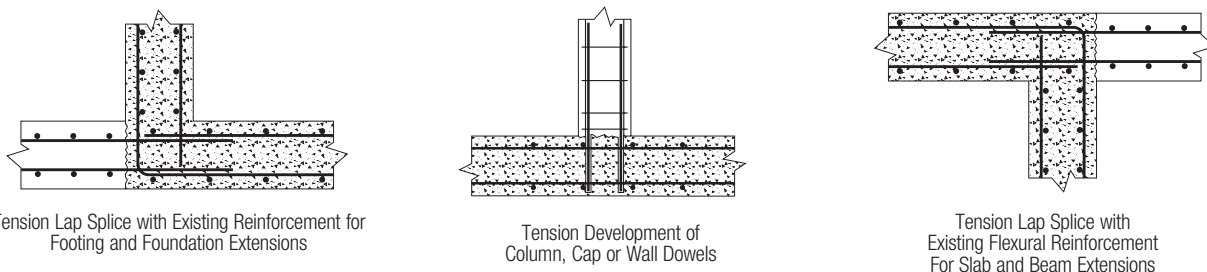

Hole Cleaning Tools and Accessories for Post-Installed Rebar Connections^{1,2,3,4,5,6,7}

Rebar Size (No.)	Drill Bit Size (inch)	Brush Size (inch)	Brush Length (inches)	Wire Brush (Cat. No.)	Plug Size (inch)	Piston Plug (Cat. No.)
3	7/16	7/16	6-3/4	08284	N/A	N/A
	1/2	1/2	6-3/4	08285	N/A	N/A
4	5/8	5/8	6-3/4	08275	N/A	N/A
5	3/4	3/4	7-7/8	08278	3/4	PFC1691520
6	7/8	7/8	7-7/8	08287	7/8	PFC1691530
	1	1	11-7/8	08288	1	PFC1691540
7	1	1	11-7/8	08288	1	PFC1691540
	1-1/8	1-1/8	11-7/8	08289	1-1/8	PFC1691550
8	1-1/8	1-1/8	11-7/8	08289	1-1/8	PFC1691550
	1-1/4	1-1/4	11-7/8	08290	1-1/4	PFC1691555
9	1-3/8	1-3/8	11-7/8	08290	1-3/8	PFC1691560
10	1-1/2	1-1/2	11-7/8	08291	1-1/2	PFC1691570
11	1-3/4	1-3/4	11-7/8	08299	1-3/4	PFC1691580

1. If the DEWALT DustX+ extraction system is used to automatically clean the holes during drilling, standard hole cleaning (brushing and blowing following drilling) is not required.
2. Holes may be drilled with hammer-drill, i.e. rotary impact drills or rock drills with a carbide drill bit (including hollow bits) or core-drill, i.e. core drill with a diamond core drill bit.
3. For any case, it must be possible for the reinforcing bar to be inserted into the cleaned hole without resistance.
4. A brush extension (Cat.#08282) must be used with a steel wire brush for holes drilled deeper than the listed brush length.
5. Brush adaptors for power tool connections are available for drill chuck (Cat.#08296) and SDS (Cat.#08283).
6. A flexible extension tube (Cat.#08297) or flexible extension hose (Cat.#PFC1640600) or equivalent approved by DEWALT must be used if the bottom or back of the anchor hole is not reached with the mixing nozzle only.
7. All overhead (i.e. upwardly inclined) installations require the use of piston plugs during where one is tabulated together with the anchor size (see table). N/A = Not applicable. All horizontal installations require the use of piston plugs where one is tabulated together with the anchor size and where the embedment depth is greater than 8 inches. A flexible extension tube (Cat.#08297) or flexible extension hose (Cat.#PFC1640600) or equivalent approved by DEWALT must be used with piston plugs.



Wire Brush



Brush Extension



Drill Chuck Adapter



SDS Adapter



Premium Piston Plug



Compressed Air Nozzle



DustX+™ System



INSTALLATION INSTRUCTIONS FOR ADHESIVE ANCHORS (SOLID BASE MATERIALS)

DRILLING

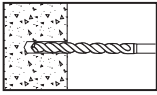

1- Drill a hole into the base material with rotary hammer drill (i.e. percussion drill) and a carbide drill bit to the size and embedment required by the selected steel hardware element (reference installation specifications for threaded rod and reinforcing bar). The tolerances of the carbide drill bits, including hollow bits, must meet ANSI Standard B212.15.

- Precaution: Use suitable eye and skin protection. Avoid inhalation of dust during drilling and/or removal.
- **Note!** In case of standing water in the drilled hole (flooded hole condition), all the water has to be removed from the hole (e.g. vacuum, compressed air, etc.) prior to cleaning.

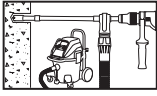

Drilling in dry base materials is recommended when using hollow drill bits (vacuum must be on).

GO TO STEP 3 FOR HOLES DRILLED WITH DUSTX+™ EXTRACTION SYSTEM (NO FURTHER HOLE CLEANING IS REQUIRED). OTHERWISE GO TO STEP 2A FOR HOLE CLEANING INSTRUCTIONS.

IN THE CASE OF AN UNDERWATER (SUBMERGED) INSTALLATION CONDITION GO TO STEP 2UW-I FOR SEPARATE SPECIFIC HOLE CLEANING INSTRUCTIONS.

HOLE CLEANING DRY OR WET/WATER-SATURATED HOLES (BLOW 2X, BRUSH 2X, BLOW 2X)



2a- Starting from the bottom or back of the drilled anchor hole, blow the hole clean a minimum of two times (2x).

- Use a compressed air nozzle (min. 90 psi) for all sizes of anchor rod and reinforcing bar (rebar).

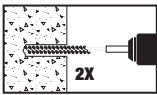

2b- Determine wire brush diameter (see hole cleaning equipment selection table) for the drilled hole and attach the brush with adaptor to a rotary drill tool or battery screw gun. Brush the hole with the selected wire brush a minimum of two times (2x). A brush extension (supplied by DEWALT) must be used for holes drilled deeper than the listed brush length.

- The wire brush diameter must be checked periodically during use. The brush should resist insertion into the drilled hole, if not, the brush is too small and must be replaced with proper brush diameter (i.e. new wire brush).

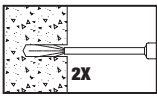

2c- Repeat Step 2a- again by blowing the hole clean a minimum of two times (2x).

- When finished the hole should be clean and free of dust, debris, ice, grease, oil or other foreign material.

NEXT GO TO STEP 3.

HOLE CLEANING UNDERWATER INSTALLATION (FLUSH, BRUSH 2X, FLUSH)

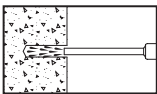

2uw-i- Starting from the bottom or back of the drilled anchor hole, rinse/flush the hole clean with air/water (air/water line pressure) until clear water comes out.

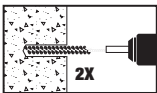

2uw-ii- Determine brush diameter (see hole cleaning equipment selection table) for the drilled hole and attach the brush with adaptor to a rotary drill tool. Brush the hole with the selected wire brush a minimum of two times (2x). A brush extension (supplied by DEWALT) must be used for holes drilled deeper than the listed brush length.

- The wire brush diameter must be checked periodically during use. The brush should resist insertion into the drilled hole, if not, the brush is too small and must be replaced with proper brush diameter (i.e. new wire brush).

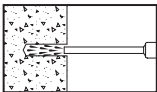

2uw-iii- Repeat Step 2a- again by rinse/flushing the hole clean with air/water.

- When finished the hole should be clean and free of dust, debris, ice, grease, oil or other foreign material.

NEXT GO TO STEP 3.

PREPARING



3- Check adhesive expiration date on cartridge label. Do not use expired product. Review Safety Data Sheet (SDS) before use. Cartridge temperature must be between 50°F - 110°F (10°C - 43°C) when in use; for overhead applications cartridge temperature must be between 50°F - 90°F (10°C - 32°C) when in use. For best experience, suggested minimum cartridge adhesive temperature is 68°F (20°C) when in use. Review published gel (working) and cure times. Consideration should be given to the reduced gel (working) time of the adhesive in warm temperatures. For permitted range of the base material temperature, see published gel and curing times.

- Attach a supplied mixing nozzle to the cartridge. Unless otherwise noted do not modify the mixer in any way and make sure the mixing element is inside the nozzle. Load the cartridge into the correct dispensing tool.
- Note: Always use a new mixing nozzle with new cartridge of adhesive and also for all work interruptions exceeding the published gel (working) time of the adhesive.

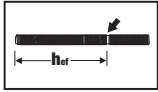

4- Prior to inserting the anchor rod or rebar into the drilled hole, the position of the embedment depth has to be marked on the anchor. Verify anchor element is straight and free of surface damage.

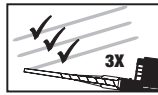

5- Adhesives must be properly mixed to achieve published properties. For new cartridges and nozzles, prior to dispensing adhesive into the drilled hole, separately dispense at least three full strokes of adhesive through the mixing nozzle until the adhesive is a consistent **RED** color.

- Review and note the published gel (working) and cure times (reference gel time and curing time table) prior to injection of the mixed adhesive into the cleaned anchor hole.

INSTALLATION

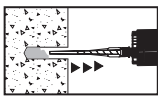

6- Fill the cleaned hole approximately two-thirds full with mixed adhesive starting from the bottom or back of the anchor hole. Slowly withdraw the mixing nozzle as the hole fills to avoid creating air pockets or voids. A plastic extension tube (Cat# 08281 or 08297) or equivalent approved by DEWALT must be used with the mixing nozzle if the bottom or back of the anchor hole is not reached with the mixing nozzle only.

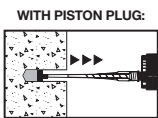

- Piston plugs (see installation specifications) must be used with and attached to the mixing nozzle and extension tube for overhead (i.e. upwardly inclined) installations and horizontal installations in concrete with anchor rod 5/8" to 1-1/4" diameter and rebar size #5 to #10. Insert piston plug to the back of the drilled hole and inject as described in the method above. During injection of the adhesive the piston plug will be naturally extruded from the drilled hole by the adhesive pressure.

- The use of piston plugs is also recommended for underwater installations for anchor rod 5/8" to 1-1/4" diameter and rebar size #5 to #10.

Attention! Do not install anchors overhead without proper training and installation hardware provided by the DEWALT. Contact DEWALT for details prior to use.

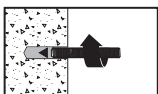

7- The anchor should be free of dirt, grease, oil or other foreign material. Push clean threaded rod or reinforcing bar into the anchor hole while turning slightly to ensure positive distribution of the adhesive until the embedment depth is reached. Observe the gel (working) time.

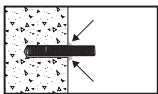

8- Ensure that the anchor element is installed to the specific embedment depth. Adhesive must completely fill the annular gap at the concrete surface. Following installation of the anchor element, remove excess adhesive. Protect the anchor element threads from fouling with adhesive. For all installations the anchor element must be restrained from movement throughout the specified curing period, (as necessary) through the use of temporary wedges, external supports, or other methods. Minor adjustment to the position of the anchor element may be performed during the gel (working) time only.

CURING AND LOADING

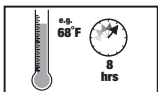

9- Allow the adhesive anchor to cure to the specified full curing time prior to applying any load (reference gel time and curing time table).

- Do not disturb, torque or load the anchor until it is fully cured.



10- After full curing of the adhesive anchor, a fixture can be installed to the anchor and tightened up to the maximum torque (reference gel time and curing time table) by using a calibrated torque wrench.

- Take care not to exceed the maximum torque for the selected anchor.

INSTALLATION INSTRUCTIONS FOR ADHESIVE ANCHORS (HOLLOW BASE MATERIALS)

DRILLING

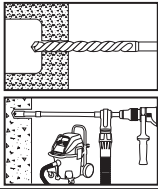

1- Drill a hole into the base material with a rotary drill tool to the size and embedment for the required screen size (see installation specifications for threaded rod in hollow concrete base material with screen tube supplied by DEWALT). Holes drilled in hollow concrete masonry units may be drilled with a rotary hammer-drill. The tolerances of the drill bit used should meet the requirements of ANSI B212.15.

- Precaution: Wear suitable eye and skin protection. Avoid inhalation of dust during drilling and/or removal.

Drilling in dry base materials is recommended when using hollow drill bits (vacuum must be on).

HOLE CLEANING (BLOW 2X, BRUSH 2X, BLOW 2X)

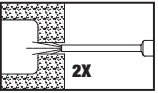

2- Starting from the bottom or back of the anchor hole, blow the hole clean with a hand pump (min. volume 25 fl.oz. supplied by DEWALT) or compressed air nozzle a minimum of two times (2x).

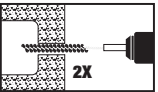

- Determine the wire brush diameter (see installation specifications) and attach the brush with adaptor to a rotary drill tool or battery screw gun. Brush the hole with the selected wire brush a minimum of two times (2x). A brush extension (supplied by DEWALT, Cat #08282) should be used for holes drilled deeper than the listed brush length.

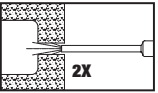

- The wire brush should be checked periodically during use. The brush should resist insertion into the drilled hole and come into contact with the sides of the drilled hole. If not the brush is too small and must be replaced.

- Finally, blow the hole clean again a minimum of two times (2x)

- When finished the hole should be clean and free of dust, debris, ice, grease, oil or other foreign material.

PREPARING



3- Check adhesive expiration date on cartridge label. Do not use expired product. Review Safety Data Sheet (SDS) before use. Cartridge temperature must be between 50°F - 110°F (10°C - 43°C) when in use. For best experience, suggested minimum cartridge adhesive temperature is 68°F (20°C) when in use. Review gel (working) time and curing time table. Consideration should be given to the reduced gel (working) time of the adhesive in warm temperatures.

- Attach a supplied mixing nozzle to the cartridge. Unless otherwise noted do not modify the mixer in any way and make sure the mixing element is inside the nozzle. Load the cartridge into the correct dispensing tool.

- Note: Always use a new mixing nozzle with new cartridges of adhesive and also for all work interruptions exceeding the published working time of the adhesive.

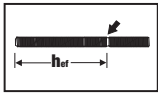

4- Prior to inserting the anchor rod into the filled screen tube, the position of the embedment depth has to be marked on the anchor. Verify anchor element is straight and free of surface damage.

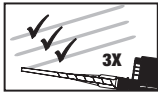

5- Adhesive must be properly mixed to achieve published properties. Prior to dispensing adhesive into the drilled hole, separately dispense at least three full strokes of adhesive through the mixing nozzle until the adhesive is a consistent RED color. Do not attach a used nozzle when changing to a new cartridge.

- Review and note the published working and cure times (see gel time and curing time table) prior to injection of the mixed adhesive into the screen tube.

INSTALLATION

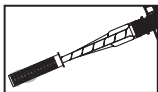

6- Select a screen tube of suitable length (supplied by DEWALT). Fill the screen tube full with adhesive starting from the bottom or back of the tube. Slowly withdraw the mixing nozzle as the screen fills to avoid creating air pockets or voids. A plastic extension tube (Cat# 08281 or 08297) or equivalent approved by DEWALT must be used with the mixing nozzle if the bottom or back of the screen tube is not reached with the mixing nozzle only.

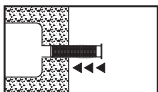

7- Insert the screen tube filled with adhesive into the cleaned anchor hole.

- Note: Overfilling the screen tube is acceptable but not required.

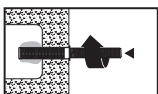

8- Prior to inserting the anchor rod into the screen tube inspect it to ensure that it is free of dirt, grease, oil or other foreign material.

- Push the threaded rod into the screen tube while turning slightly to ensure positive distribution of the adhesive until back of the tube is reached.

- Note: In cases where the drilled hole size is larger than specified due to rotary drilling (e.g. an elongated opening), the annular space between the screen tube and the hole at the base material surface must be filled with adhesive.

CURING AND FIXTURE

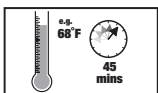

9- Allow the adhesive anchor to cure to the specified full curing time prior to applying any load.

- Do not disturb, torque or load the anchor until it is fully cured (see gel time and curing time table).

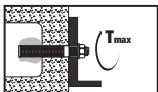

10- After full curing of the adhesive anchor, a fixture can be installed to the anchor and tightened up to the maximum torque (see installation specifications for threaded rod in hollow base material) by using a calibrated torque wrench.

- Take care not to exceed the maximum torque for the selected anchor.

INSTALLATION INSTRUCTIONS (POST-INSTALLED REBAR)

HAMMER DRILLING

DRILLING

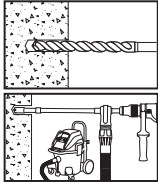

1- Drill a hole into the base material with rotary hammer drill (i.e. percussion drill) and a carbide drill bit to the size and embedment required by the selected steel hardware element (reference installation specifications for threaded rod and reinforcing bar). The tolerances of the carbide drill bits, including hollow bits, must meet ANSI Standard B212.15.

- Precaution: Use suitable eye and skin protection. Avoid inhalation of dust during drilling and/or removal.
- **Note!** In case of standing water in the drilled hole (flooded hole condition), all the water has to be removed from the hole (e.g. vacuum, compressed air, etc.) prior to cleaning.

Drilling in dry base materials is recommended when using hollow drill bits (vacuum must be on).

GO TO STEP 3 FOR HOLES DRILLED WITH DUSTX+™ EXTRACTION SYSTEM (NO FURTHER HOLE CLEANING IS REQUIRED). OTHERWISE GO TO STEP 2A FOR HOLE CLEANING INSTRUCTIONS.

HOLE CLEANING DRY OR WET HOLES (BLOW 2X, BRUSH 2X, BLOW 2X)

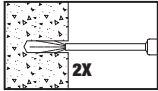

2a- Starting from the bottom or back of the drilled hole, blow the hole clean a minimum of two times (2x). Use a compressed air nozzle (min. 90 psi) for all sizes of reinforcing bar (rebar).

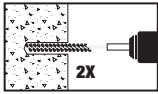

2b- Determine brush diameter (see hole cleaning accessories for post-installed rebar selection table) for the drilled hole and brush the hole by hand or attach the brush with adaptor to a rotary drill tool or battery screw gun. Brush the hole with the selected wire brush a minimum of two times (2x).

- A brush extension (supplied by DEWALT) must be used for drill hole depth than the listed brush length. The wire brush diameter must be checked periodically during use; The brush should resist insertion into the drilled hole, if not the brush is too small and must be replaced with the proper brush diameter (i.e. new wire brush).

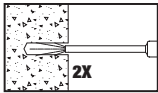

2c- Repeat Step 2a again by blowing the hole clean a minimum of two times (2x). When finished the hole should be clean and free of dust, debris, oil or other foreign material.

NEXT GO TO STEP 3.

CORE DRILLING

DRILLING

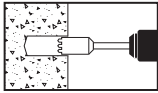

1- Drill a hole into the base material with a core drill tool to the size and embedment required by the selected steel hardware element

Precaution: Use suitable eye and skin protection. Avoid inhalation of dust during drilling and/or removal.

HOLE CLEANING (RINSE, BRUSH 2X, RINSE, BLOW 2X)

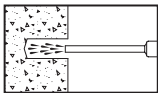

2a- Starting from the bottom or back of the drilled hole, rinse/flush the hole clean with air/water (air/water line pressure) until clear water comes out.

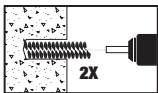

2b- Determine brush diameter (see hole cleaning accessories for post-installed rebar selection table) for drilled hole and attach the brush with adaptor to a rotary drill tool or battery screw gun. Brush the hole with the selected wire brush a minimum of two times (2x).

- A brush extension (supplied by DEWALT) must be used for holes drilled deeper than the listed brush length. The wire brush diameter must be checked periodically during use. The brush should resist insertion into the drilled hole, if not the brush is small and must be replaced with the proper brush diameter (i.e. new wire brush).

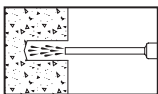

2c- Repeat Step 2a again by rinse/flush the hole clean with water.

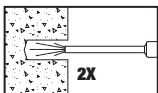

2d- Starting from the bottom or back of the drilled anchor hole, blow the hole clean a minimum if two times (2x). Use a compressed air nozzle (min. 90 psi) for all sizes of anchor rod and reinforcing bar (rebar)

When finished the hole should be clean and free of water, debris, oil or other foreign material.

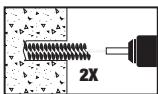

2e- Repeat Step 2b again by brushing the hole with a wire brush a minimum if two times (2x).

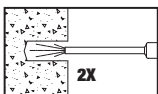

2f- Repeat Step 2d again by blowing the hole clean a minimum if two times (2x).

When finished the hole should be clean and free of water, debris, oil or other foreign material.

NEXT GO TO STEP 3.

PREPARING



3- Check adhesive expiration date on cartridge label. Do not use expired product. Review Safety Data Sheet (SDS) before use. Review published gel (working) and cure times. Cartridge adhesive temperature must be between 50°F - 110°F (10°C - 43°C) when in use; except for overhead applications cartridge adhesive temperature must be between 50°F - 90°F (10°C - 32°C) when in use. For best experience, the suggested minimum cartridge adhesive temperature is 68°F (20°C) when in use. Consideration should be given to the reduced gel (working) time of the adhesive in warm temperatures. For the permitted range of the base material temperature see published gel and cure times.

Attach a supplied mixing nozzle to the cartridge. Unless otherwise noted do not modify the mixer in any way and make sure the mixing element is inside the nozzle. Load the cartridge into the correct dispensing tool.

- Note: Always use a new mixing nozzle with new cartridge of adhesive and also for all work interruptions exceeding the published gel (working) time of the adhesive.

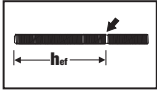

4- Prior to inserting the rebar into the filled drilled hole, the position of the embedment depth has to be marked on the anchor. Verify anchor element is straight and free of surface damage.

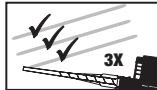

5- Adhesive must be properly mixed to achieve published properties. Prior to dispensing adhesive into the drilled hole, separately dispense at least three full strokes of adhesive through the mixing nozzle until the adhesive is a consistent **RED** color.

Review and note the published gel (working) and cure times prior to injection of the mixed adhesive into the cleaned anchor hole.

INSTALLATION

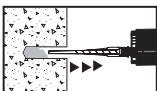

6- Fill the cleaned hole approximately two-thirds full with mixed adhesive starting from the bottom or back of the anchor hole. Slowly withdraw the mixing nozzle as the hole fills to avoid creating air pockets or voids. A flexible extension tube (Cat.# 08297) or flexible extension hose (Cat.# PFC1640600) or equivalent approved by DEWALT must be used with the mixing nozzle if the bottom or back of the anchor hole is not reached with the mixing nozzle only (see hole cleaning tools and accessories for post-installed rebar table).

Note: Piston plugs must be used with and attached to mixing nozzle and extension tube for overhead (i.e. upwardly inclined) installations and horizontal installations with rebar sizes as indicated in the hole cleaning tools and accessories for post-installed rebar table. Insert piston plug to the back of the drilled hole and inject as described in the method above. During injection of the adhesive the piston plug will be naturally extruded from the drilled hole by the adhesive pressure.

Attention! Do not install anchors overhead or upwardly inclined without installation hardware supplied by DEWALT and also receiving proper training and/or certification. Contact DEWALT for details prior to use.

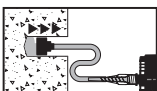

WITH PISTON PLUG:



7- The reinforcing bar should be free of dirt, grease, oil or other foreign material. Push clean rebar into the anchor hole while turning slightly to ensure positive distribution of the adhesive until the embedment depth is reached. Observe the gel (working) time.

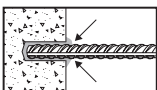

8- Ensure that the reinforcing bar is installed to the specified embedment depth. Adhesive must completely fill the annular gap at the concrete surface. Following installation of the rebar, remove excess adhesive. For all installations the rebar must be restrained from movement throughout the specified curing period, (as necessary) through the use of temporary wedges, external supports, or other methods. Minor adjustments to the position of the rebar may be performed during the gel (working) time only.

CURING AND LOADING

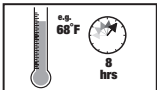

9- Allow the adhesive anchor to cure to the specified full curing time prior to applying any load (reference gel time and curing time table).

- Do not disturb, torque or load the anchor until it is fully cured.

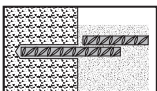

10- After full curing of the rebar connection, new concrete can be poured (placed) to the installed rebar connection.

REFERENCE INSTALLATION TABLES

Gel (working) Time and Curing Table

Temperature of base material		Gel (working) time	Full curing time
°F	°C		
41	5	120 minutes	48 hours
50	10	90 minutes	24 hours
68	20	25 minutes	8 hours
86	30	20 minutes	6 hours
95	35	15 minutes	6 hours
104	40	12 minutes	4 hours
110	43	10 minutes	4 hours

Linear interpolation for intermediate base material temperature is possible.

Cartridge adhesive temperature must be between 50°F - 110°F (10°C - 43°C) when in use; for overhead applications cartridge adhesive temperature must be between 50°F - 90°F (10°C - 32°C) when in use. For best adhesive dispensing experience, suggested minimum cartridge adhesive temperature is 68°F (20°C) when in use.

Hole Cleaning Equipment Selection Table for Pure110+ Adhesive Anchors^{1,2,3}

Rod Diameter (inch)	Rebar Size (No.)	ANSI Drill Bit Diameter ¹ (inch)	Brush Length, L (inches)	Steel Wire Brush ^{2,3} (Cat. #)	Blowout Tool	Number of cleaning actions
Solid Base Material						
3/8	#3	7/16	6-3/4	08284	Compressed air nozzle only, Cat #8292 (min. 90 psi)	2x blowing 2x brushing 2x blowing
1/2	-	9/16	6-3/4	08285		
-	#4	5/8	6-3/4	08275		
5/8	#5	11/16	7-7/8	08286		
		3/4	7-7/8	08278		
3/4	#6	7/8	7-7/8	08287		
7/8	#7	1	11-7/8	08288		
1	#8	1-1/8	11-7/8	08289		
1-1/4	#9	1-3/8	11-7/8	08290		
-	#10	1-1/2	11-7/8	08291		
Hollow Base Material (with plastic screen tube)						
3/8	-	9/16	6-3/4	08285	Compressed air nozzle only, Cat #8292 (min. 90 psi)	2x blowing 2x brushing 2x blowing
1/2	-	3/4	7-7/8	08278		
5/8	-	7/8	7-7/8	08287		
3/4	-	1	11-7/8	08288		

1. For any case, it must be possible for the steel anchor element to be inserted into the cleaned hole without resistance.
2. An SDS-plus adaptor (Cat. #08283) or Jacobs chuck style adaptor (Cat. #08296) is required to attach a steel wire brush to the drill tool.
3. A brush extension (Cat. #08282) must be used with a steel wire brush for holes drilled deeper than the listed brush length.

Piston Plugs for Adhesive Anchors^{1,2,3,4}

Plug Size (inch)	ANSI Drill Bit Diameter (inch)	Piston Plug (Cat. #)	Piston Plug
Solid Base Materials			
11/16	11/16	08258	
3/4	3/4	08259	
7/8	7/8	08300	
1	1	08301	
1-1/8	1-1/8	08303	
1-1/4	1-1/4	08307	
1-3/8	1-3/8	08305	
1-1/2	1-1/2	08309	

1. All overhead installations require the use of piston plugs where one is tabulated together with the anchor size.
2. All horizontal installations require the use of piston plugs where one is tabulated together with the anchor size and where the embedment depth is greater than 8 inches.
3. The use of piston plugs is also recommended for underwater installations where one is tabulated together with the anchor size.
4. A flexible plastic extension tube (Cat. #08281 or #08297) or equivalent approved by DEWALT must be used with piston plugs.

ORDERING INFORMATION

ADHESIVES

PURE110+[®]
Epoxy Injection Adhesive Anchoring System

Pure110+ Cartridges

Cat. No.	Description	Std. Box	Std. Ctn.	Pallet
08310SD	Pure110+ 9 fl. oz. Quik-Shot cartridge (1:1 mix ratio)	12	24	432
08321SD	Pure110+ 20.5 fl. oz. dual cartridge (1:1 mix ratio)	12	-	540
08351SD	Pure110+ 50.5 fl. oz. dual cartridge (1:1 mix ratio)	5	-	

One Pure110+ mixing nozzle is packaged with each cartridge.
Pure110+ mixing nozzles must be used to ensure complete and proper mixing of the adhesive.



Cartridge System Mixing Nozzles and Nozzle Extensions

Cat. No.	Description	Std. Pkg.	Std. Ctn.
PFC1641600	Mixing nozzle (with 8" extension) for Pure110+ Quik-Shot	2	24
08609	Extra high flow mixing nozzle (with 8" extension) for Pure110+ dual cartridge	2	24
08281	Mixing nozzle extension, 8" long	2	24
08297	Mixing nozzle extension, 18" long	1	12
PFC1640600	Flexible Extension Hose, 25 ft.	1	12



Dispensing Tools for Injection Adhesive

Cat. No.	Description	Std. Box	Std. Ctn.
08437	Manual caulking gun for Quik-Shot	1	12
08479	High performance caulking gun for Quik-Shot	1	12
DCE560D1	Cordless 20v Battery powered dispensing tool for Quik-Shot	1	-
08409	20.5 fl. oz. Standard metal manual tool	1	10
08421	20.5 fl. oz. High performance manual tool	1	10
DCE591D1	20.5 fl. oz. cordless 20v Battery powered dispensing tool	1	-
08413	20.5 fl. oz. Pneumatic tool	1	-
08438	50.5 fl. oz. Pneumatic tool	1	-



Hole Cleaning Tools and Accessories

Cat No.	Description	Std. Box
08284	Wire brush for 7/16" or 1/2" ANSI hole, 6-3/4" length	1
08285	Wire brush for 9/16" ANSI hole, 6-3/4" length	1
08275	Wire brush for 5/8" ANSI hole, 6-3/4" length	1
08286	Wire brush for 11/16" ANSI hole, 7-7/8" length	1
08278	Wire brush for 3/4" ANSI hole, 7-7/8" length	1
08287	Wire brush for 7/8" ANSI hole, 7-7/8" length	1
08288	Wire brush for 1" ANSI hole, 11-7/8" length	1
08289	Wire brush for 1-1/8" ANSI hole, 11-7/8" length	1
08276	Wire brush for 1-1/4" ANSI hole, 11-7/8" length	1
08290	Wire brush for 1-3/8" ANSI hole, 11-7/8" length	1
08291	Wire brush for 1-1/2" ANSI hole, 11-7/8" length	1
08273	Wire brush for 1-5/8" ANSI hole, 11-7/8" length	1
08299	Wire brush for 1-3/4" ANSI hole, 11-7/8" length	1
08283	SDS-plus adapter for steel brushes	1
08296	Standard drill adapter for steel brushes (e.g. Jacobs Chuck)	1
08282	Steel brush extension, 12" length	1
08292	Air compressor nozzle with extension, 18" length	1

Piston Plugs for Adhesive Anchors

Cat. No.	Description	ANSI Drill Bit Dia.	Qty.
08258	11/16" Plug	11/16"	10
08259	3/4" Plug	3/4"	10
08300	7/8" Plug	7/8"	10
08301	1" Plug	1"	10
08303	1-1/8" Plug	1-1/8"	10
08305	1-3/8" Plug	1-3/8"	10
08309	1-1/2" Plug	1-1/2"	10

Piston Plugs for Post-Installed Rebar Connections

Cat. No.	Description	ANSI Drill Bit Dia.	Qty.
PFC1691520	3/4" Plug	3/4"	10
PFC1691530	7/8" Plug	7/8"	10
PFC1691540	1" Plug	1"	10
PFC1691550	1-1/8" Plug	1-1/8"	10
PFC1691555	1-1/4" Plug	1-1/4"	10
PFC1691560	1-3/8" Plug	1-3/8"	10
PFC1691570	1-1/2" Plug	1-1/2"	10
PFC1691580	1-3/4" Plug	1-3/4"	10

Plastic Screen Tubes



Cat. No.	Description	ANSI Drill Diameter	Standard Carton
08310	3/8" x 3-1/2" Plastic Screen	9/16"	25
08311	3/8" x 6" Plastic Screen	9/16"	25
08313	3/8" x 8" Plastic Screen	9/16"	25
08315	1/2" x 3-1/2" Plastic Screen	3/4"	25
08317	1/2" x 6" Plastic Screen	3/4"	25
08321	5/8" x 6" Plastic Screen	7/8"	25
08323	3/4" x 6" Plastic Screen	1"	10

For availability of stainless steel screen tubes, Contact DEWALT



SDS Max 4-Cutter Carbide Drill Bits

Cat. No.	Diameter	Usable Length	Overall Length
DW5806	5/8"	8"	13-1/2"
DW5809	5/8"	16"	21-1/2"
DW5807	5/8"	31"	36"
DW5808	11/16"	16"	21-1/2"
DW5810	3/4"	8"	13-1/2"
DW5812	3/4"	16"	21-1/2"
DW5813	3/4"	31"	36"
DW5814	13/16"	16"	21-1/2"
DW5815	7/8"	8"	13-1/2"
DW5816	7/8"	16"	21-1/2"
DW5851	7/8"	31"	36"
DW5817	27/32"	16"	21-1/2"
DW5818	1"	8"	13-1/2"
DW5819	1"	16"	22-1/2"
DW5852	1"	24"	29"
DW5820	1"	31"	36"
DW5821	1-1/8"	10"	15"
DW5822	1-1/8"	18"	22-1/2"
DW5853	1-1/8"	24"	29"
DW5854	1-1/8"	31"	36"
DW5824	1-1/4"	10"	15"
DW5825	1-1/4"	18"	22-1/2"

Dust Extraction

Cat. No.	Description
DWV012	10 Gallon Wet/Dry Hepa/Rrp Dust Extractor DWV9402 Fleece bag (5 pack) for DEWALT dust extractors DWV9316 Replacement Anti-Static Hose DWV9320 Replacement HEPA Filter Set (Type 1)
DWH050K	Dust Extraction with two interchangeable drilling heads
DCB1800B	1800 Watt Portable Power Station & Parallel Battery Charger Bare Unit

SDS+ Full Head Carbide Drill Bits



Cat. No.	Diameter	Usable Length	Overall Length
DW5502	3/16"	2"	4-1/2"
DW5503	3/16"	4"	6-1/2"
DW5504	3/16"	5"	8-1/2"
DW5506	3/16"	10"	12"
DW5512	7/32"	8"	10"
DW5517	1/4"	4"	6"
DW5518	1/4"	6"	8-1/2"
DW55200	1/4"	10"	12"
DW5521	1/4"	12"	14"
DW5524	5/16"	4"	6"
DW5526	5/16"	10"	12"
DW5527	3/8"	4"	6-1/2"
DW5529	3/8"	8"	10"
DW55300	3/8"	10"	12"
DW5531	3/8"	16"	18"
DW5537	1/2"	4"	6"
DW5538	1/2"	8"	10-1/2"
DW5539	1/2"	10"	12"
DW5540	1/2"	16"	18"



SDS+ 4-Cutter Carbide Drill Bits

Cat. No.	Diameter	Usable Length	Overall Length
DW5471	5/8"	8"	10"
DW5472	5/8"	16"	18"
DW5474	3/4"	8"	10"
DW5475	3/4"	16"	18"
DW5477	7/8"	8"	10"
DW5478	7/8"	16"	18"
DW5479	1"	8"	10"
DW5480	1"	16"	18"
DW5481	1-1/8"	8"	10"
DW5482	1-1/8"	6"	18"

Hollow Drill Bits

	Cat. No.	Diameter	Overall Length	Usable Length	Recommended Hammer
SDS+	DWA54012	1/2"	14-1/2"	9-3/4"	DCH133 / DCH273 / DCH293
	DWA54916	9/16"	14-1/2"	9-3/4"	DCH133 / DCH273 / DCH293
	DWA54058	5/8"	14-1/2"	9-3/4"	DCH133 / DCH273 / DCH293
	DWA54034	3/4"	14-1/2"	9-3/4"	DCH133 / DCH273 / DCH293
SDS Max	DWA58058	5/8"	23-5/8"	15-3/4"	DCH481 / D25603K
	DWA58958	5/8"	47-1/4"	39-3/8"	DCH481 / D25603K
	DWA58116	11/16"	24-3/4"	15-3/4"	DCH481 / D25603K
	DWA58034	3/4"	23-5/8"	15-3/4"	DCH481 / D25603K
	DWA58934	3/4"	47-1/4"	39-3/8"	DCH481 / D25603K
	DWA58078	7/8"	23-5/8"	15-3/4"	DCH481 / D25603K
	DWA58001	1"	23-5/8"	15-3/4"	DCH481 / D25603K
	DWA58901	1"	47-1/4"	39-3/8"	DCH481 / D25603K
	DWA58118	1-1/8"	23-5/8"	15-3/4"	DCH481 / D25603K
	DWA58918	1-1/8"	47-1/4"	39-3/8"	DCH481 / D25603K
	DWA58114	1-1/4"	47-1/4"	39-3/8"	DCH481 / D25603K
	DWA58138	1-3/8"	47-1/4"	39-3/8"	DCH481 / D25603K
	DWA58112	1-1/2"	47-1/4"	39-3/8"	DCH481 / D25603K

