

**MIGUTAN FP... Illustrated Install Data, Wet-Setting-Bed Method**

March 2017, Page 1 of 12

Illustrated Installation Instructions--Wet-Setting-Bed Method**MIGUTAN FP... Series with Long Side-Sheets (min. 11-inch, 280mm)**

IMPORTANT! Do not install this material until all members of your crew have read and understand these instructions. If any of the crew do not understand any part of these instructions call EMSEAL: **1-800-526-8365 or 508-836-0280**

This product can only fulfill its design function if it has been correctly selected and correctly installed. This means that joint width (after allowance for concrete shrinkage), total joint movement and expected load must have been considered and accounted for.

These installation instructions are generic and may need adapting to suit specific project requirements and unique conditions. Consult EMSEAL if necessary.

The MIGUTAN system is an elastomer/metal system that is bolted down onto a flat, level surface that will bring the top surface of the MIGUTAN level with the finished floor level or slightly recessed in the case of joints subject to vehicular or snow-plow traffic and where the integral cover plate option is selected.

INSTALLATION METHODS--TWO WAYS

There are two different ways to install the rails of this system:

A) Double-Nut Method; B) Wet-Setting-Bed Method.

These instructions are for the Wet-Setting-Bed Method. If your application calls for or if you wish to review the alternative Double-Nut-Method, please contact EMSEAL.

These instructions are for installation of MIGUTAN with Long (min. 11-inch or 280mm) side sheets.

If your application calls for or if you wish to review installation with short side sheets, please contact EMSEAL.

System Components:

- 1) Epoxy setting bed
- 2) Rails
- 3) Rail Clamping Spacer
- 4) Long Side Sheet
- 5) Sealing Insert
- 6) Retainer Capping Strip
- 7) Retainer Screws w/
Nylon seating gasket
- 8) Anchor nut-channel
filled to cover epoxy
anchors

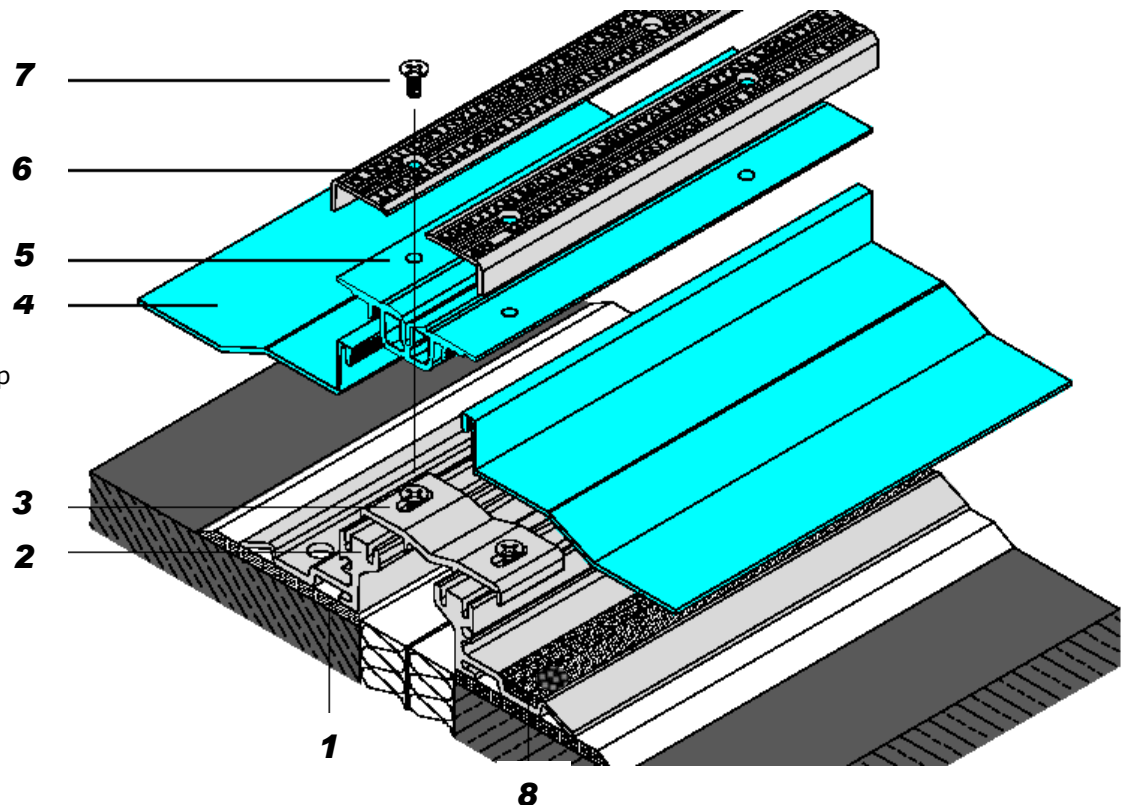

EQUIPMENT LIST

(In addition to normal tools of the trade and safety equipment, the following material and equipment must be on-site before the EMSEAL Technician arrives or before installation can begin):

<p>For Proper Working Environment:</p> <ul style="list-style-type: none"> □ 2 saw horses and 1 sheet plywood (for worktable) □ Generator, fuel, and accessories <u>or</u> access to reliable high-amperage power source <p>For Preparing and Drilling Concrete</p> <ul style="list-style-type: none"> □ 4-inch angle grinder(s) with diamond cup blade(s) and abrasive blade(s) for metal □ compressed air with small gauge extension tube □ minimum 2 ea - Hammer Drills with depth guides □ minimum 6 ea - Hammer drill bits, 3/8-inch diameter, suitable for masonry/concrete <ul style="list-style-type: none"> □ minimum 6 ea - Round wire brushes ("plumbers brush") for cleaning-out anchor holes <p>For Cutting and Drilling Aluminum and Stainless Steel</p> <ul style="list-style-type: none"> □ 15-inch power miter saw (optional depending on size and complexity of job—call EMSEAL to discuss) <ul style="list-style-type: none"> □ minimum 14-inch carbide-tipped blade for power miter saw for cutting aluminum □ minimum 14-inch thin, carburundum blade for power miter saw for cutting stainless steel □ "Sawz-all" (reciprocating saw) □ long and short metal cutting blades for sawz all □ minimum 6 ea - <u>carburundum (abrasive)</u> blades for "sawz-all" □ cutting-oil ("3-in-1" or equal) □ drill Index with sizes 1/32-inch to 1/2-inch minimum □ high-speed metal countersink bits, 3/4-inch □ standard industrial-grade high-speed drill □ 5mm and 8mm high speed drill bits (for preparing new holes in rails and caps at cuts) □ 6mm taps and tap wrench □ small hand-held metal (fine-toothed) file (for removing metal burrs after cutting) 	<p>For Mixing and Spreading Epoxy Setting-Bed Material</p> <ul style="list-style-type: none"> □ paddle mixers "jiffy mixers" for use in electric drill □ minimum 6 ea - 1 1/2" wide by min. 8-inch long margin trowels □ Clean or unused plaster/paint pails to mix epoxy, hold cleaning solvents, etc. <p>For Removing, Reinstalling, Screws in Capping Strips</p> <ul style="list-style-type: none"> □ Screw Gun(s)--to remove and reinstall stainless steel screws. Screw-guns instead of drills are required to help prevent stripping □ minimum 6 ea - #3 screw-gun bits □ torque wrench with adapter to accept #3 screw-gun tip □ 3 - plastic spray bottles (1 bottle with soapy water), (1 bottle with acetone solvent), and (1 bottle with clean water) □ rubber mallet □ small soldering iron with pencil point tip <p>Other Miscellaneous Tools and Materials</p> <ul style="list-style-type: none"> □ levels, 2-foot, 4-foot, and torpedo-level □ 100-foot tape measure □ combination square □ chalk box with chalk □ Flat bar and small pry bar □ 5-gal pail of acetone (depending on the size of the job, less acetone may be adequate—consult EMSEAL) □ box of clean, dry, lint-free, cloth (not paper) rags □ vise grips (2-pair) □ shop vac □ extension cords with 4-way box □ 1/4" diameter Awl □ 2 - 9/16" open-end wrenches and/or 9/16" deep drive sockets & ratchets
--	---

Installation: WET-SETTING-BED METHOD

The Principle

The principle used in this method for adjusting the height of the system is to tap the system down into a wet epoxy-mortar setting bed until the top surface of the joint is at the desired elevation relative to the finished wear-course level (i.e. flush with the finished deck level or slightly recessed in the case of joints to receive vehicular or snow-plow traffic).

Check that sufficient height between the top of the structural slab (or curb cast onto and pinned into the structural slab) and finished elevation of the topping exists to accommodate the specific MIGUTAN model being installed.

There should be enough room to accommodate the height of the MIGUTAN plus at least 6-9mm (1/4 - 3/8-inch) thick setting bed. See MIGUTAN Tech Data for a chart of available rail leg heights.

STEP 1: Prepare Deck Surface

- Using a grinder or sand-blaster, clean and prepare a 6" wide strip on either side of the joint gap (or if a curb is being cast on which to seat the MIGUTAN, similarly prepare the top surface of the curb). The resulting concrete surface must be clean, dry, and free of all dirt and contaminants and must be the correct depth below the finished floor level. See MIGUTAN Tech Data or appropriate job-specific details.
- Thoroughly blow clean the deck surface and at least 5-feet of the adjacent work area along the entire joint length.
- Any significant unevenness in the deck surface or spalling at the joint edge must be repaired with a suitable patching material using proper shelf geometry for spall repair.

STEP 2: Lay Out the Joint

- Lay out the MIGUTAN rails onto the deck and over the joint-gap so you can become acquainted with the system.
- The system is supplied with the rails clamped together by metal spacers at a distance near the midpoint of its movement range. Installation at temperatures other than mean seasonal temperature may necessitate on-site adjustment. Consult EMSEAL or the owner's responsible engineer before proceeding.

DO NOT REMOVE CLAMPING SPACERS BETWEEN RAILS UNTIL TOLD TO DO SO LATER IN THESE INSTRUCTIONS.

- Each length is 4 meters or 13.12 ft (approximately 13'-1 7/16") long. Each end is marked with a number that is in sequence with the number of the preceding length. Lay the lengths down, end-to-end, matching-number to matching-number.
- In the case of the FP.../45, 60, 88, 95, & 115, positive interlocking between abutting lengths is obtained by staggering the upper and lower parts of the rails at the joins between each length.
- The FP .../25 & 6000S have solid (not sliding) rails. Stainless steel pins factory-installed in the ends of each length join the lengths of these models. Steel leg systems are joined by butting consecutive sections.
- Push sections with matching numbers together ensuring that staggered sections interlock and overlap by 100mm (4-inches) or that stainless-steel pins are properly seated.
- Continue the above process along the entire length of the expansion joint system. When you reach the end, a piece of sliding rail will now project 100 mm (4-inches). Cut it off and bring it back to the beginning of the joint and insert it into the space left at the beginning.
- Check length of final piece(s) and mark for cutting.

NOTE: Where rails are cut leaving more than 3-inches of undrilled flange and stainless steel cap it will be necessary to drill new holes to accommodate hardware.

STEP 3: Site Fabricate Transitions and/or Connect Factory-Fabricated Transitions

- If the system contains special pieces or transitions such as tees or right angles, these must be site-measured, cut and fabricated (or connected if factory-fabricated) at this stage to complete the system.
- With the joint lengths carefully positioned from the starting point, measure and mark out all pieces requiring cutting and fitting. Care is needed here.
- MEASURE TWICE AND CUT ONCE is a good motto. If suitable cutting equipment, such as an accurate, power miter chop saw or power hacksaw, is not available on site, take the parts to a machine shop for cutting.

NOTE: see last section of these instructions: "Special Conditions--Installing Transitions and Terminations".

Factory-fabricated 90-degree upturn positioned as starting point for installation run.

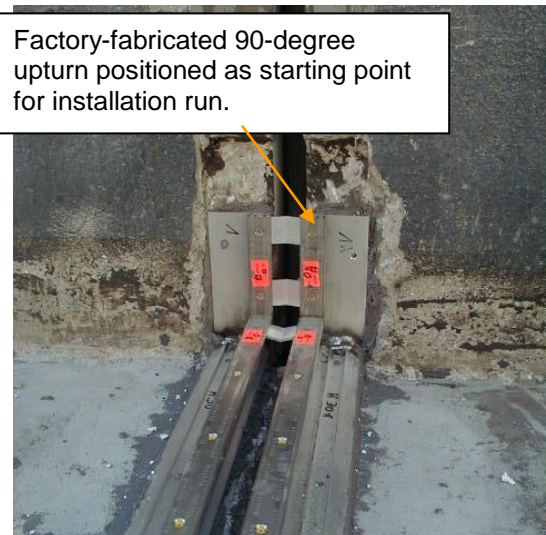

STEP 4: Turn Rails Upside Down and Solvent Wipe

- Turn the rails upside down and wipe clean with rags made damp with an oil-cutting solvent.

Be careful not to recontaminate the rails or work area.

Shipping crates for rails.

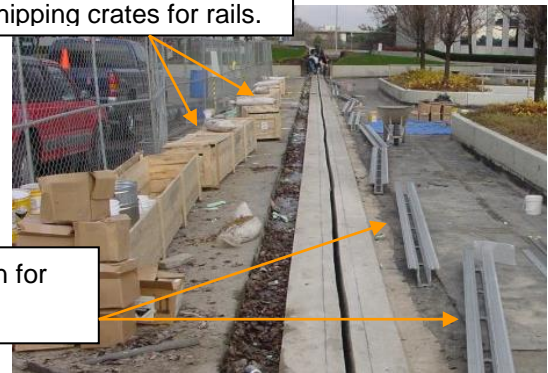

Rails turned upside down for solvent wiping.

STEP 5: Lay Setting Bed

- Use the EMSEAL Setting Bed Kit containing epoxy Parts A & B and Sand. Empty the solid content of Part A into an empty 5-gallon mixing pail. Add the liquid contents of Part B into the same pail. Immediately mix with a heavy-duty mixing drill and 3-inch diameter mixing paddle to a solid gray consistency (45 – 60 sec.). Immediately pour the sand into the center of the A+B mixture, while stirring with the heavy-duty mixing drill and 3-inch diameter mixing paddle. Blend the epoxy and sand to a uniform gray color and consistency (approx. 2 minutes after sand is fully added).
- Lay epoxy-mortar setting bed approximately 9mm (3/8-inch) thick X 127mm (5-inches) wide) on both sides of joint gap approx. the length of 2 joint sections, i.e. 8 meters (26.24 feet).
- The setting bed must be of consistent thickness across and lengthwise. Ensure that there are no voids that would leave the rails unsupported at any point.



Epoxy Mortar setting bed.

NOTE: Width of the epoxy-mortar bed may vary depending on the size of the joint-gap. The narrower the joint-gap, the wider the setting bed must be. The thickness of the epoxy-mortar bed may vary depending on irregularity of the concrete deck and the desired distance from the finished wearing surface (top of deck).

STEP 6: Lower Rails into Wet Setting Bed

- Lower the first length of MIGUTAN rails into the wet, epoxy-mortar setting bed.
- Tap the system down into the setting bed until the upper surface is at the required level.
- Ensure that the flanges are fully embedded in the wet epoxy and that no hollow areas exist beneath the flanges.
- Lower the next length of MIGUTAN into the wet-epoxy leveling bed making sure it is interlocked with the previous section.



- Ensure that joints are properly executed to achieve proper appearance and performance.
- Repeat procedure until final section is reached.
- Install final section by lifting previous section slightly until the sections can be interlocked.
- Allow epoxy-mortar setting bed to cure in accordance with the epoxy manufacturer's recommended curing time.

STEP 7: Cut Through Clamping Spacers After Epoxy is CURED

IMPORTANT! You must now cut through the clamping spacers between the two sides of each rail using the Sawz-All with metal cutting blade.

THIS IS IMPORTANT BECAUSE TEMPERATURE CHANGES IN THE CONCRETE AND CONSEQUENT JOINT MOVEMENT WILL SERIOUSLY DAMAGE THE ALUMINUM COMPONENTS IF THEY REMAIN RIGIDLY CONNECTED TOGETHER.

STEP 8: Drill Anchor Holes

- Drill 3/8" diameter holes for 5/16" diameter anchors (or as specified for the particular job or anchoring system--consult EMSEAL).
- Drill holes to depth to suit length of anchors ensuring that anchor-bolts project at least 75mm (3-inches) into concrete.



- Thoroughly clean dust from holes using compressed air blast, wire brushing with a round wire brush and then vacuuming.



STEP 9: Install Epoxy Anchors

- Screw nuts onto ends of anchors



- Inject anchor epoxy into holes

Anchor-epoxy mixing gun.

Anchor-epoxy Part A

Anchor-epoxy Part B

Static-mixing nozzle blends parts A & B together and dispenses mixed epoxy into holes

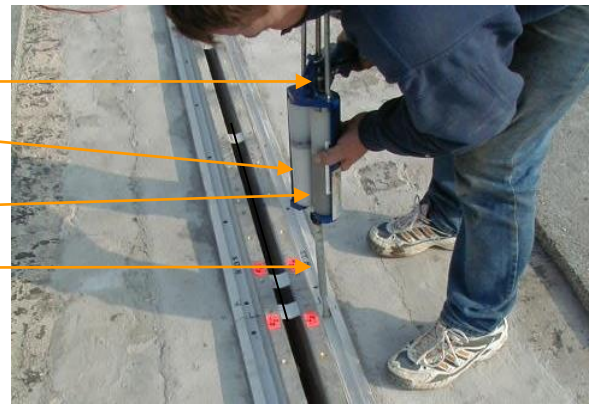

- Install anchors into wet epoxy
- Spin anchor **once** 360° to ensure epoxy completely surrounds and coats the anchor.

(TIP: remove excess epoxy from around the nut that might obstruct tightening later.)

- Allow epoxy to cure according to chart(s) on epoxy cartridge.



STEP 10: Tighten Nuts

- With anchors secured in **cured** epoxy, tighten the nuts onto the mounting flanges.



- In cases where anchors protrude above the plane of the nut channel, cut off excessive anchor height and grind to remove any sharp edges that might damage waterproofing membrane.
- Fill recessed nut channel with sealant, hot rubberized asphalt or grout in order to create a smooth surface for the deck membrane to lie on and to prevent damage to the membrane.

STEP 11: Install Rubber Parts

- Remove the stainless steel retainer caps
- Lay them alongside the joint, and mark them so they can be re-installed on the same section of rail. Do not mix them up, as the pre-drilled holes in the retainer caps may not line up with the holes in the rails.



- Remove rubber filler strips from "reglets" in top of rails
- remove plastic plugs from screw holes in topside of rail.

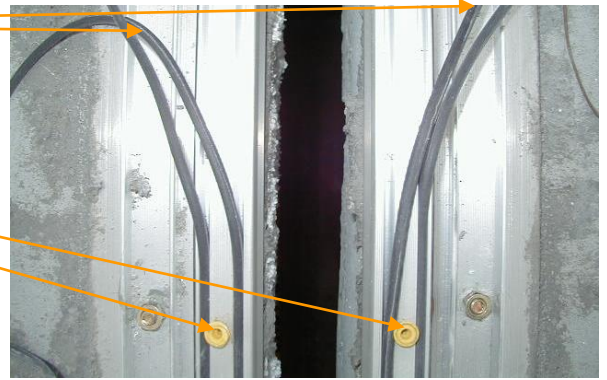

- Roll out flashing side sheets along the edges of the joint



(TIP—Spray locking dart with mildly soapy water to makes insertion easier).



- press locking rib into outer groove on rail
- tap the locking rib with a rubber mallet to ensure it is securely seated



- Unroll the center sealing-gland and press its locking ribs into the inner grooves of the rail.



- Spray the sealing-gland locking dart with mildly soapy water to assist in installation.



- Tap the locking rib with a rubber mallet to ensure it is securely seated



STEP 12: Install Stainless Steel Retaining Caps

- Locate the hole for the stainless steel screws at the beginning of the first section of the rail and make a hole in the flange of the center sealing insert using an 1/4" awl or small-tipped soldering iron.
- Anchor this first section of the stainless steel retainer cap with one of the screws and nylon seating washers provided



- Using the retainer cap as a template, make the rest of the holes along the length of the center-sealing insert using the awl or small-tipped soldering iron.
- Install the stainless steel retaining caps, using the stainless steel screws and nylon seating washers supplied.
- Tighten screws using a torque-wrench and phillips screw bit--torque to 7 N-m (5.2 lb.ft.).

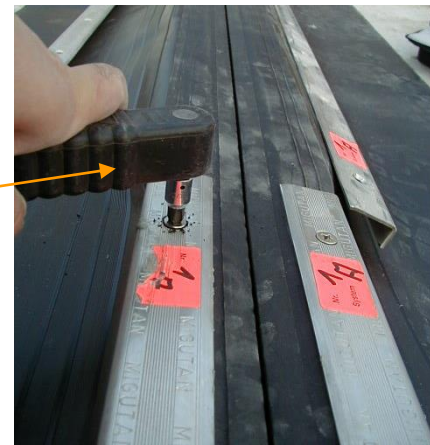

IMPORTANT!

8 TO 10 DAYS AFTER INSTALLATION, SCREWS MUST BE TORQUED AGAIN TO THE SAME FIGURE.

STEP 13: Integrate Deck Waterproofing Components

- Lift the side-sheet and apply the hot-rubberized asphalt (or deck waterproofing membrane) over the anchoring flange and up the FULL HEIGHT of the vertical leg of the rail.
- If using hot-rubberized asphalt, you now lay the side-sheet into the still-hot rubberized asphalt, pressing it firmly into the 90° corner of the rail. *(If using sheet-type waterproofing membrane, apply contact adhesive, mastic, or other emulsion to the deck waterproofing membrane as well as to the underside of the MIGUTAN side-sheet. Lay the side-sheet back down, pressing it firmly into the 90° bend formed by the rail and anchoring flange).*
- Apply an additional layer of hot-rubberized asphalt over the side-sheet to fully encapsulate the horizontal and vertical surfaces of the side-sheet. *(If using sheet membrane, apply manufacturer's non-sag mastic over MIGUTAN side-sheet and adhere an additional strip of the deck waterproofing membrane over the seam of the MIGUTAN side-sheet and the deck waterproofing membrane and up the vertical to completely encapsulate the MIGUTAN side sheet).*
- Install protection board and other waterproofing system components as required by manufacturer of waterproofing membrane system to cover over the encapsulated side sheets.

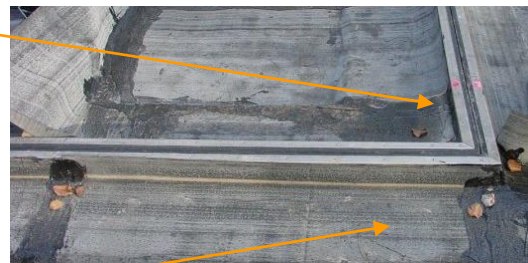

STEP 14: Install Pavers or Deck Topping/Form Control Joints

- If installing pavers or asphalt as the wearing surface, these can be installed directly against the Migutan and its stainless steel caps.
-
- (NOTE: If asphalt is being installed where vehicular traffic is expected, place 6mm (1/4-inch) thick protection plate over the exposed top surface of the MIGUTAN and compact asphalt up to the sides of this form).



- If installing concrete as the wearing surface, a sealant control joint between the stainless steel caps and concrete must be created.
- Set a 6mm (1/4-inch) wide X 20mm (3/4-inch) deep form against stainless steel caps, and cast concrete up to this form.
- After concrete has cured, remove forms and fill control joints with self-leveling, traffic grade sealant (Dow 888 SL, or similar).

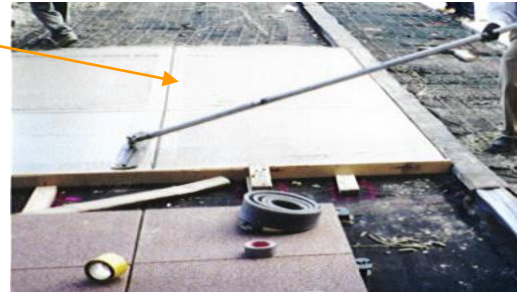

STEP 15: Retighten Top Screws

- 8 to 10 days after installation re-torque the capping screws to 7 N-M (5 ft.lb).

***Installation using the "wet-setting-bed" method is now complete
See following pages for transitions, terminations, and special conditions.***

INSTALLING TRANSITIONS AND TERMINATIONS

Where expansion joints begin, end and run adjacent to, over, under, or around obstructions such as walls, columns, curbs, sidewalks, planters etc., are typically where leaks persist even after straight runs of joints have been properly sealed. Options exist to properly seal these areas.

Transitions and Terminations in Metal Parts:

- It is usual to order most transitions and terminations as factory-fabricated, welded items which are joined to straight runs in the field.

The components that make up any factory-fabricated item would be welded together in the configuration represented by contractor-supplied drawings and dimensions.

Factory-fabricated, welded flat 90-degree turn in MIGUTAN rails, and stainless steel capping strips.



- If the contractor has to fabricate transitions and terminations in the metal parts in the field, metal parts can be cut on-site using suitable equipment such as a Sawz-All with metal-cutting abrasive blades. Cut metal components must be welded or held in the proper location using anchors.

Transitions and Terminations in the Side-Sheets:

NOTE: It is critical to achieving watertightness that wherever a transition or termination exists, the side-sheets be properly welded to follow all contours at the condition such that they may be properly integrated with the deck waterproofing materials.

- It is usual to order transitions and terminations in the side flashing sheets as factory-fabricated, welded items along with the corresponding welded metal parts. The components that make up any factory-fabricated item would be welded together in the configuration represented by contractor-supplied drawings and dimensions.



NOTE: It is difficult to accurately represent all substrate contours that the side-sheets will come in contact with. For this reason factory-welded side sheets cannot be guaranteed to fit and may require field modification by the contractor.

Transitions and Terminations in Sealing Gland:

- Transitions and terminations in the sealing gland must be ordered as factory-fabricated items.

Most transitions and terminations in the sealing gland can be factory fabricated to drawings and measurements on centerlines provided by the installer. If transitions and terminations are not supplied factory-welded to the straight lengths, they can be butt-welded to straight lengths in the field. Welding is the responsibility of the contractor. Equipment and training for the proper execution of butt-welds is available from EMSEAL.

Factory-fabricated flat-90-degree turns in sealing gland.

Factory-fabricated tee in sealing gland.

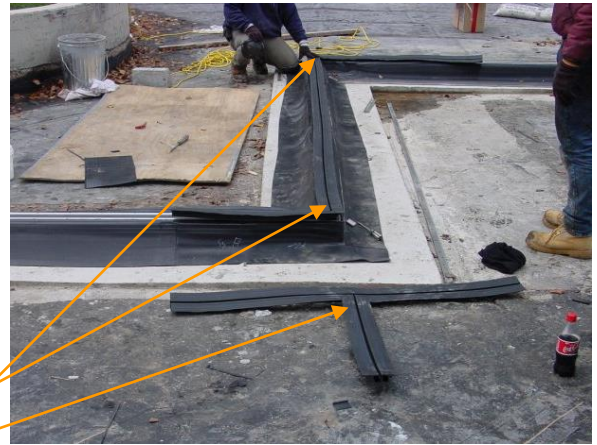

SPECIAL CONDITIONS:**ANCHORING THE FP.../25 with side-sheets and counter sunk anchors**

- If the FP.../25 is being used with side-sheets for integration with waterproofing, an additional step in anchoring and different anchors must be used.
- Because of the low profile height of the FP.../25, there is no recessed anchor-nut channel in which to keep the nut from breaking the plane of the waterproofing and side sheets. For this reason countersink anchors must be used.
- Countersink the holes in the flanges of the FP.../25 using a 3/4-inch diameter, 82° countersink bit. (If using other than EMSEAL supplied anchors, use appropriate countersink bit).
- 3/8-inch diameter holes in concrete will be required to receive a 3/8-inch diameter by 3 3/4-inch long, flat, countersink head expansion anchor.
- Drill holes on 300mm (12-inch) centers staggering them using the pre-drilled inner and outer rows of holes in the FP.../25 flanges as a guide.

NOTE: Staggering the holes is important to avoid creating a stress line in the concrete edge.

ANCHORING TO VERTICAL SURFACES

- The FP... series is available in a deck-to-wall configuration designated "E-2".
- This requires the "wall" flange to be attached to a vertical surface using 5/16-inch diameter x 2 1/2-inch long, flat head, countersink, expansion anchors set into 5/16-inch diameter holes on 300mm (12-inch) centers.
- A setting-bed or light coating of epoxy is required behind the vertical leg to act as a dielectric separator and/or to fill irregularities. The setting bed must be thick enough to ensure that the flange is fully supported across its entire contact area, and that the side sheet will terminate against a smooth and regular surface.
- The side flashing sheet should extend as far as possible up the vertical surface in order to provide the best possible waterproofing and must extend at least high enough to anchor the upper edge in a reglet and with a termination bar and sealant.
- Where reglets already exist they must always be used in addition to the termination bar for terminating the MIGUTAN side sheets on vertical surfaces.
- Where reglets do not already exist and cannot be cut, use the following:

a) Above-Grade and/or Above Snowline:

Where MIGUTAN is installed in walls and/or above (clear-of) grade and/or snowline, the side-sheet can extend a minimum of 50mm (2-inches) above the top of the MIGUTAN and can be installed without a reglet but must have termination-bar and sealant.

b) Below-Grade and/or Below Snowline:

Where MIGUTAN is installed below-grade outer-edge of side-sheets must be terminated between a sandwich of waterproofing membranes.

Where MIGUTAN is installed below the snowline on roofs, deck-wall conditions, and/or at upturn terminations at columns, parapets, etc., side-sheets must extend above-grade and/or snowline. The edges of the side-sheets must be terminated with a termination bar and sealant.

- In all cases, the side-sheets and termination bar must be protected from direct exposure to the sun and elements.
- Termination bar must be at least 40mm (1 1/2-inches) at its widest point, with edges bent and with pre-punched holes on 100mm (4-inch) centers. Sealant above the termination bar will be supplied by others and must be compatible and have good adhesion to the sealant being used in vertical joints on the rest of the building.
- Spacing of anchors in termination bar must be at least every 8-inches (200mm) on center.